



With the inflated BEAM Module now attached to the Space Station, the **Age of Inflatables** has begun! The perfect segue to the dawn of recoverable & reusable rocket first stages – **making space affordable!**

## INDEX

2 Co-sponsoring Organizations

### NEWS SECTION pp. 3-89

3-22 Earth Orbit and Mission to Planet Earth

23 Space Tourism

23-31 Cislunar Space and the Moon

32-48 Mars

49-52 Asteroids & Comets

53-69 Other Planets & their moons

70-89 Starbound

### ARTICLES, ESSAYS pp 91-107

91 A list of more “Human Space Firsts” Peter Kokh

92 Geologically “Earthlike” worlds without a large moon might not host life, P. Kokh

93 At last, the BEAM inflatable test module is attached to the Space Station

95 Spotting a Ringworld edge on against its sun as seen from Earth

96 A US Department of Space – Madhu Thangavelu

99-103 New Challenges in Space For the Next President of United States: The United States and Its International and Commercial Partners can Reshape Federal Space Priorities Dave Dunlop

104-107 What Happens When the Sky Starts to Fall? Kim Pearl

108-109 OP-ED Articles

111 List of major articles in our sister publications: Ad Astra and Moon Miners’ Manifesto

### STUDENTS & TEACHERS pp 112-116

## TTSIQ Sponsor Organizations

**About The National Space Society** – <http://www.nss.org/>

The National Space Society was formed in March, 1987 by the merger of the L5 Society and National Space institute. NSS has an extensive chapter network in the United States and a number of international chapters in Europe, Asia, and Australia. NSS hosts the International Space Development Conference in May each year at varying locations. NSS publishes **Ad Astra** magazine quarterly. NSS actively tries to influence US Space Policy.

**About The Moon Society** – <http://www.moonsociety.org>

The Moon Society was formed in 2000 and seeks to inspire and involve people everywhere in exploration of the Moon with the establishment of civilian settlements, using local resources through private enterprise both to support themselves and to help alleviate Earth's stubborn energy and environmental problems. The Society has a network of chapters in the US and has been an affiliate of NSS since 2005.

**About Space Renaissance Initiative** – <http://www.spacerenaissance.org/>

SRI's focus is on use of space resources to address the challenges of runaway population growth and increasing use of Earth resources at a non-sustainable pace. "The settlement of space would benefit all of humanity by opening a new frontier, energizing society, providing room and resources for the growth of the human race without despoiling Earth, creating a lifeboat for humanity that could survive even a planet-wide catastrophe."

**About The Mars Foundation** – <http://marsfoundation.org/> – <http://marshome.org/>

The Foundation seeks to involved interested persons in the design of Mars outposts and settlements, maximizing use of building materials that can be produced on Mars, to illustrate the near-term feasibility of establishing a permanent human presence on Mars.

**About Open Luna Foundation** – <http://openluna.org/missions>

The OpenLuna Foundation aims to return to the moon through private enterprise. A stepped program of robotic missions, then a short series of manned missions to construct a small, approximately 8 person outpost .

**About SEDS: Students for the Exploration and Development of Space** – <http://www.seds.org/>

SEDS is an independent, student-based organization promoting the exploration and development of space by educating people about the benefits of space, via a network of interested students, providing an opportunity

**About Moon Miners' Manifesto** – <http://www.MMM-MoonMinersManifesto.com>

MMM, has been published 10 times a year since issue #1 December 1986 by the Milwaukee Lunar Reclamation Society chapter of the **National Space Society**. It has also served **the Moon Society** and its predecessor, Artemis Society International, since October 1995.

Most issues deal with the **opening of the Lunar frontier**, suggesting how pioneers can make best use of **local resources** and learn to **make themselves at home**. This will involve psychological, social, and physiological adjustment. Much of what will hold for the **Moon**, will also hold true for **Mars** and for space in general. There is one Mars theme issue each year, and occasionally **other space destinations** are discussed: the asteroids, Moon (Jupiter), Titan (Saturn), even the cloud tops of Venus, and interstellar destinations beyond.



## Keeping up with the Space News – How we do it

Peter Kokh, Editor, [kokhmmm@aol.com](mailto:kokhmmm@aol.com)

A feature of this publication from the outset has been **Space News Browsing Links**; Putting this news section together requires checking the news daily. To do this I rely on a variety of sources, but I started with just one. Some years back, the Moon Society had arranged for the current daily “space news” (guided by a number of key words which the society had supplied) from a free web search service. <http://www.moonsociety.org/zebrafeeds/demo.php?zflist=Space-News&zfrim=20news>

This service automatically put the latest news on the home page. While in their total redesign of their website, the Moon Society web team chose not to incorporate this feature, this link is still active, but not advertised, and I access it via **the address above**, checking it daily.

I have also found a number of other sources, **most of them updated weekly**

- [www.space.com](http://www.space.com) --- <http://www.moondaily.com> --- <http://www.marsdaily.com>
- <http://www.saturndaily.com> --- <http://www.terradaily.com> --- <http://www.spacedaily.com>
- <http://www.skynightly.com> --- <http://www.gpsdaily.com> --- <http://www.solardaily.com>

I have also found a number of other sources, **most of them updated weekly**

- [www.space.com](http://www.space.com) --- <http://www.moondaily.com> --- <http://www.marsdaily.com>
- <http://www.saturndaily.com> --- <http://www.terradaily.com> --- <http://www.spacedaily.com>
- <http://www.skynightly.com> --- <http://www.gpsdaily.com> --- <http://www.solardaily.com>

It is not uncommon for the same story to be listed on more than one of the above sites.

The latest addition to my source list, updated weekly, includes news the sites above may miss.

- <http://phys.org/space-news/> – articles on this site, when they cover a story found on one or more of the sites above, tend to be a bit more complete and professional. More importantly, this site commonly lists one or more relevant space news items missed by the other sites.

I cover these news items, with an image if any and a brief summary, in **TTSIQ**. ##



## SPACEPORT NEWS

### NASA Interested in Using Russia's Vostochny Spaceport

[www.spacedaily.com/reports/NASA\\_Interested\\_in\\_Using\\_Russias\\_Vostochny\\_Spaceport\\_999.html](http://www.spacedaily.com/reports/NASA_Interested_in_Using_Russias_Vostochny_Spaceport_999.html)

11 April, 2016 – Although NASA has voiced no concrete plans to use it yet, The Russian space agency's deputy chief said Roscosmos and NASA were looking at out how they could use the spaceport in Russia's Far East jointly in "a not-so-distant future." ##

### Russia to shift all Lunar launches to Vostochny Cosmodrome

[www.space-travel.com/reports/Russia\\_to\\_shift\\_all\\_Lunar\\_launches\\_to\\_Vostochny\\_Cosmodrome\\_999.html](http://www.space-travel.com/reports/Russia_to_shift_all_Lunar_launches_to_Vostochny_Cosmodrome_999.html) – [https://en.wikipedia.org/wiki/Vostochny\\_Cosmodrome](https://en.wikipedia.org/wiki/Vostochny_Cosmodrome)



15 April, 2016 – Russia will stop using the Soviet-era Baikonur cosmodrome in Kazakhstan for lunar launches. All operations linked to Russia's moon mission to the Vostochny cosmodrome, in far eastern Siberia, which unlike Baikonur, is within Russian territory. ##

### Vostochny After First Launch: Gearing Up for Missions to Moon, Mars

[www.space-travel.com/reports/Russian\\_Firm\\_Develops\\_Project\\_of\\_Reusable\\_Spacecraft\\_for\\_Lunar\\_Missions\\_999.html](http://www.space-travel.com/reports/Russian_Firm_Develops_Project_of_Reusable_Spacecraft_for_Lunar_Missions_999.html)

30 May, 2016 - Following the 1st launch of a Soyuz spacecraft with 3 satellites on board, Russia's all-new Vostochny spaceport in the Far East will stay idle for a year pending the completion of the 2nd stage of construction.

a great deal of work is yet to be done to make Vostochny suitable to launch manned missions to space. Including the construction of a nearby town of Tsiolkovsky to accommodate the cosmodrome personnel and those working at related facilities.

This means that while pitching the new spaceport to potential clients, Russia will still be paying Kazakhstan for the use of the veteran Baikonur space launch center.

**The first manned flight from Vostochny is slated for 2023**, when the Federatsiya space shuttle is placed in orbit by an Angara-A5V heavy-lift rocket, which is at the heart of Russia's lunar program.##

## ROCKET & SPACE PLANE NEWS

### Jeff Bezos' Blue Origin Launches & Lands Private Rocket for 3rd Time

2 April, 2016 – [www.space.com/32453-blue-origin-launches-and-lands-rocket-third-time.html](http://www.space.com/32453-blue-origin-launches-and-lands-rocket-third-time.html)  
[www.space.com/32456-blue-origin-rocket-comes-in-hot-nails-landing-video.html](http://www.space.com/32456-blue-origin-rocket-comes-in-hot-nails-landing-video.html)  
<http://phys.org/news/2016-04-blue-rocket-successful-vertical.html>  
[www.space.com/32846-blue-origin-rocket-s-on-board-camera-snags-incredible-descent-view-video.html](http://www.space.com/32846-blue-origin-rocket-s-on-board-camera-snags-incredible-descent-view-video.html)

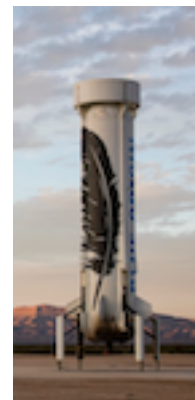

**Left:** capsule    **Middle:** the launch    **Right:** rocket minus capsule after landing

During today's unmanned test, Blue Origin's New Shepard rocket and capsule launched into suborbital space from the company's West Texas test site, its proving ground for reusable boosters. After reaching 339,178 feet = 64 miles (103 km) the capsule separated in space and returned to Earth via a parachute, while the New Shepard rocket descended on a plume of fire in its 3rd vertical landing. ##  
 Nb. The capsule name "Blue Origin" is a reference to our ocean-blue planet, Earth.

## Private Lynx Space Plane Could Take Off in Early 2017

5 April, 2016 - [www.space.com/32463-xcor-lynx-space-plane-2017.html](http://www.space.com/32463-xcor-lynx-space-plane-2017.html)  
[www.space.com/32104-how-xcor-s-lynx-space-plane-works-infographic.html](http://www.space.com/32104-how-xcor-s-lynx-space-plane-works-infographic.html)

Lynx's four-engine propulsion system is nearly ready to go, and the prototype could conceivably take to the skies for the first time in early 2017, Lynx has seats for one pilot and one paying passenger. The vehicle will take off and land horizontally on a runway, like an airplane. But it will go much higher than any commercial jet, reaching a maximum altitude of about 64 miles (103 kilometers).



## India to launch its scaled down reusable space plane in May

[www.spaceflightinsider.com/organizations/isro/india-launch-reusable-spaceplane-may](http://www.spaceflightinsider.com/organizations/isro/india-launch-reusable-spaceplane-may)



5 April, 2016 - The Indian Space Research Organisation (ISRO) has announced that it is on track to launch its first reusable spaceplane as early as May.

The Reusable Launch Vehicle (RLV) is scheduled to conduct maiden flight to evaluate various technologies needed to develop a fully reusable space vehicle.

The RLV, is a scaled-down prototype (some 6.5 meter (21.3 ft) in length) of a future uncrewed single-stage reusable spaceplane, known as Avatar, that is being designed by the ISRO.

The May mission will be a technology demonstrator (RLV-TD) to test

✓ powered cruise flight, ✓ autonomous landing and ✓ hypersonic flight using an air-breathing propulsion system.

The spacecraft resembles a small winged aircraft, and will be launched from the first launchpad of the Satish Dhawan Space Centre to an altitude of 70 km (43 miles) atop a two-stage Rohini sounding rocket and then released. It will re-enter the atmosphere and travel back to Earth in a controlled descent, to be recovered from the Bay of Bengal.

Past TTSIQ issues are online at: [www.moonsociety.org/international/ttsiq/](http://www.moonsociety.org/international/ttsiq/) and at: [www.nss.org/tothestars/](http://www.nss.org/tothestars/)

## NASA to Improve Solar Electric Propulsion for Deep Space Exploration

[www.nasa.gov/press-release/nasa-works-to-improve-solar-electric-propulsion-for-deep-space-exploration](http://www.nasa.gov/press-release/nasa-works-to-improve-solar-electric-propulsion-for-deep-space-exploration)

19 April, 2016 – Advanced solar electric propulsion will be needed for future human expeditions into deep space, including to Mars. Shown below is a **13-kilowatt Hall thruster** being evaluated at NASA's Glenn Research Center in Cleveland.

Hall thrusters trap electrons in a magnetic field and use them to ionize the onboard propellant. It uses 10 times less propellant than equivalent chemical rockets.

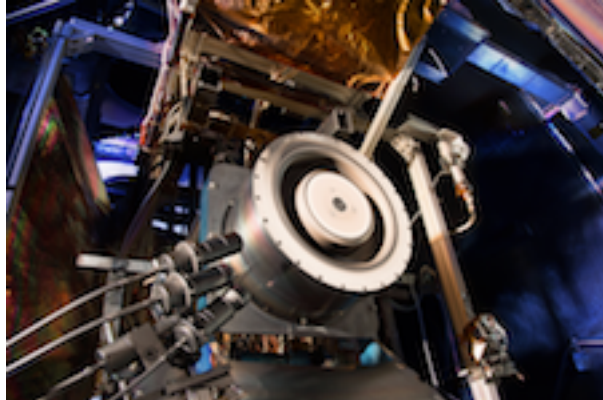

##

## SpaceX Launches CRS-8 Space Station Re-Supply Mission | Video

### SpaceX Rocket Landing At Sea Captured By On-Board Camera, Chase Plane | Video

[www.space.com/32519-spacex-launches-crs-8-space-station-re-supply-mission-video.html](http://www.space.com/32519-spacex-launches-crs-8-space-station-re-supply-mission-video.html)

[www.space.com/32526-spacex-rocket-landing-at-sea-captured-by-on-board-camera-chase-plane-video.html](http://www.space.com/32526-spacex-rocket-landing-at-sea-captured-by-on-board-camera-chase-plane-video.html) – 8 April, 2016

[www.nasaspaceflight.com/2016/04/spacex-dragon-rtf-falcon9-launch/](http://www.nasaspaceflight.com/2016/04/spacex-dragon-rtf-falcon9-launch/)

[www.space.com/32527-spacex-rocket-landing-sea-amazing-videos.html](http://www.space.com/32527-spacex-rocket-landing-sea-amazing-videos.html)

[www.space.com/32845-spacex-ocean-rocket-landing-video.html](http://www.space.com/32845-spacex-ocean-rocket-landing-video.html)

[www.space.com/32843-spacex-s-hottest-and-fastest-landing-yet-3-different-angles-video.html](http://www.space.com/32843-spacex-s-hottest-and-fastest-landing-yet-3-different-angles-video.html)



<http://phys.org/news/2016-04-spacex-futuristic-pop-up-room-rocket.html>

[www.space.com/32757-spacex-rocket-landing-360-degree-view.html](http://www.space.com/32757-spacex-rocket-landing-360-degree-view.html)

## China testing own reusable rocket technologies

[www.spacedaily.com/reports/China\\_testing\\_own\\_reusable\\_rocket\\_technologies\\_999.html](http://www.spacedaily.com/reports/China_testing_own_reusable_rocket_technologies_999.html)

25 April, 2016 – Chinese experts have already built a prototype model to test theories on the reusable rocket booster's landing subsystems. They have completed "experimental verifications" using "multiple parachutes" supposedly attached to the booster. ##

## More Power! SpaceX's Rockets Are Stronger Than Predicted

2 May, 2016 - [www.space.com/32767-spacex-rockets-falcon-9-capabilities.html](http://www.space.com/32767-spacex-rockets-falcon-9-capabilities.html)

The company has revised the maximum-payload capabilities of the two boosters. The Falcon 9 can actually haul 50,265 lbs. (22,800 kilograms) to low Earth orbit (LEO) and 18,300 lbs. (8,300 kg) to geosynchronous transfer orbit (GTO); the previously cited figures were 28,990 lbs. (13,150 kg) and 10,690 lbs. (4,850 kg), respectively. ##



SpaceX's Falcon 9 rocket lifts off from Cape Canaveral Air Force Station on April 8, 2016, sending the robotic Dragon cargo capsule on its way to the International Space Station.

## Wow! SpaceX Nails Rocket Landing At Sea Again

5 May, 2016 - [www.space.com/32811-spacex-rocket-landing-jcsat-14-launch.html](http://www.space.com/32811-spacex-rocket-landing-jcsat-14-launch.html)

[www.space.com/32810-spacex-lands-again-first-stage-on-droneship-despite-extreme-velocities-video.html](http://www.space.com/32810-spacex-lands-again-first-stage-on-droneship-despite-extreme-velocities-video.html) - [www.space.com/32808-photos-spacex-jcsat-14-launch-rocket-landing.html](http://www.space.com/32808-photos-spacex-jcsat-14-launch-rocket-landing.html)

<http://phys.org/news/2016-05-spacex-successfully-rockets-stage-space.html>

For the 2nd time in a month, SpaceX has landed the first stage of its Falcon 9 rocket on a ship at sea.

The booster settled softly onto the deck of SpaceX's robotic "Of Course I Still Love You" droneship (barge) at 1:30 a.m. EDT (0530 GMT) on Friday, May 6, nine minutes after launching from Cape Canaveral Air Force Station in Florida on a successful mission to carry the Japanese communications satellite JCSAT-14 to orbit.



SpaceX's Falcon 9 rocket hit its target precisely on May 6, 2016, landing in the center of the deck of the drone ship "Of Course I Still Love You." - ##

## White House Report Endorses FAA Oversight of Commercial Space Missions

4 May, 2016 - [www.space.com/32791-commercial-space-missions-faa-oversight.html](http://www.space.com/32791-commercial-space-missions-faa-oversight.html)

The White House has endorsed a proposal where the U.S. Federal Aviation Administration (FAA) would provide oversight of "non-traditional" commercial space activities, eliminating a policy barrier for proposed missions beyond Earth orbit. A "mission authorization" regime, with a minimal degree of government oversight, would ensure the U.S. upholds its obligations under the 1967 Outer Space Treaty.

Past TTSIQ issues are online at: [www.moonsociety.org/international/ttsiq/](http://www.moonsociety.org/international/ttsiq/) and at: [www.nss.org/tothestars/](http://www.nss.org/tothestars/)

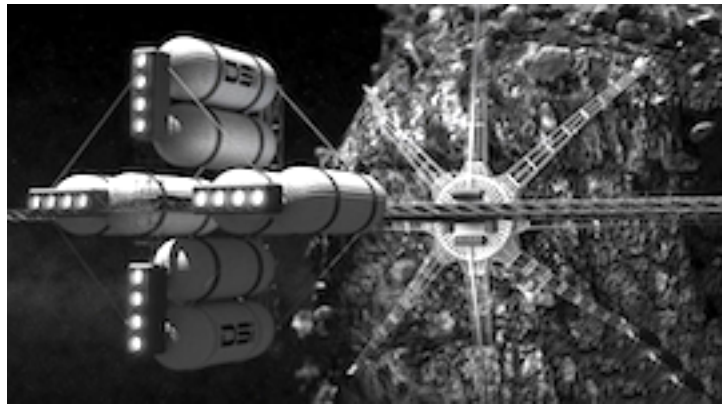

Asteroid mining is one emerging commercial space application that isn't currently covered by U.S. regulations needed to provide oversight as required by the Outer Space Treaty.

"The economic vitality of the American space industry is best served with a clear and predictable oversight process that ensures access to space and imposes minimal burdens on the industry." ##

## Orbital Targets July for 1st Flight of Redesigned Antares Rocket

[www.space.com/32813-orbital-targets-july-for-1st-flight-of-redesigned-antares-rocket.html](http://www.space.com/32813-orbital-targets-july-for-1st-flight-of-redesigned-antares-rocket.html)



6 May, 2016 – Orbital ATK's redesigned Antares rocket, with different Russian first-stage propulsion, should make its first flight from Wallops Island, Virginia, in July.

Synergies with other Orbital businesses mean Antares is profitable even if it wins no business beyond the 2-3 launches per year planned for NASA. ##

## SpaceX's new price chart illustrates performance cost of reusability

<http://spacenews.com/spacexs-new-price-chart-illustrates-performance-cost-of-reusability/>



Go to <http://spacenews.com/wp-content/uploads/2016/05/spacex-price.gif> for full scale chart



2 May, 2016 – SpaceX's updated price chart shows the significant performance difference between the partially reusable and fully expendable versions of the Falcon 9 Full Thrust and Falcon Heavy rockets. The reusable Falcon 9's performance to GTO is listed at 5,500 kilograms. The same rocket in fully expendable version can lift 50 percent more payload — 8,300 kilograms. For the Falcon Heavy, the performance to GEO is about 2.8x that of the reusable version. The prices here are for geostationary-orbit launches. They should not be used as a guide to low-orbit or Mars missions. ##

## Boeing's 1st 'Full-Blown' Starliner Space Capsule Takes Shape

13 May, 2016 – [www.space.com/32873-boeing-first-starliner-crew-capsule.html](http://www.space.com/32873-boeing-first-starliner-crew-capsule.html)  
[www.space.com/32881-boeing-starliner-test-article-literally-coming-together-video.html](http://www.space.com/32881-boeing-starliner-test-article-literally-coming-together-video.html)



Boeing's first CST-100 Starliner in one piece inside the Commercial Crew and Cargo Processing Facility at Kennedy Space Center, Florida after Structural Test Article's upper/lower domes were mated together.

## Glider to Surf the Sky to the Edge of Space

17 May, 2016 – [www.space.com/32899-glider-to-surf-sky-to-the-edge-of-space.html](http://www.space.com/32899-glider-to-surf-sky-to-the-edge-of-space.html)



The Perlan 2 glider during a May 9 test flight over Minden, Nevada

A decade after adventurer and pilot Steve Fossett sailed an engine-less airplane 50,722 feet into the stratosphere, a follow-on glider will attempt to best the record by riding mountain air waves to **90,000 feet**, more than twice as high as commercial jets fly.

With backing from Airbus, the Perlan Project's second glider is wrapping up a series of test flights in Nevada before it will be shipped to Argentina in August to attempt a new altitude record. ##

**Editor:** IIRC, at 90,000 ft on Earth, the air pressure is similar to that within the Hellas basin on Mars.

These experiments could lead to the first aircraft on Mars, a big boost towards settlement. ##

## Reusable Rocket Launch Systems: How They Work ( Infographic )

[www.space.com/22433-reusable-rocket-launch-systems-dc-x-infographic.html](http://www.space.com/22433-reusable-rocket-launch-systems-dc-x-infographic.html)

- Unrealized early concepts

## Blue Origin Aces 4th Reusable Rocket Launch/Landing in Live Webcast

19 June, 2016 - [www.space.com/33214-blue-origin-lands-reusable-rocket-4th-time-webcast.html](http://www.space.com/33214-blue-origin-lands-reusable-rocket-4th-time-webcast.html)  
[www.space.com/33217-wow-blue-origin-launches-capsule-and-rocket-lands-both-again-video.html](http://www.space.com/33217-wow-blue-origin-launches-capsule-and-rocket-lands-both-again-video.html)  
<http://www.space.com/33215-touchdown-blue-origin-rocket-lands-after-launching-capsule-video.html>  
<http://www.space.com/33218-blue-origin-capsule-lands-with-only-2-parachutes-in-test-video.html>  
<http://www.space.com/33216-blue-origin-4th-rocket-launch-landing-in-photos.html>

[www.nasa.gov/press-release/nasa-electric-research-plane-gets-x-number](http://www.nasa.gov/press-release/nasa-electric-research-plane-gets-x-number)

## TECHNOLOGIES & ROBOTICS

### World's blackest material makes NASA's ultra-black paint look like it's not even black

19 April, 2016 - [www.techinsider.io/vantablack-vs-hubble-telescope-black-paint-2016-4](http://www.techinsider.io/vantablack-vs-hubble-telescope-black-paint-2016-4)

The paint used on the Hubble telescope is one of the blackest materials in space, used to reduce stray light so the instrument can photograph the best possible images of our solar system and beyond.

Researchers from British company Surrey NanoSystems have now made something much, much blacker. Their material, awesomely called "Vantablack", is so black that they can't even measure how dark it is. It makes Aeroglaze look like it's not even black. When the researchers shine a light on the two, you can see the Hubble paint reflecting light back, but not Vantablack. ##

### 2D Spacecraft, Reprogrammable Microbes & More: NASA Wild Space Tech Ideas

1 May, 2016 - [www.space.com/32749-nasa-wild-space-tech-ideas-niac-2016.html](http://www.space.com/32749-nasa-wild-space-tech-ideas-niac-2016.html)

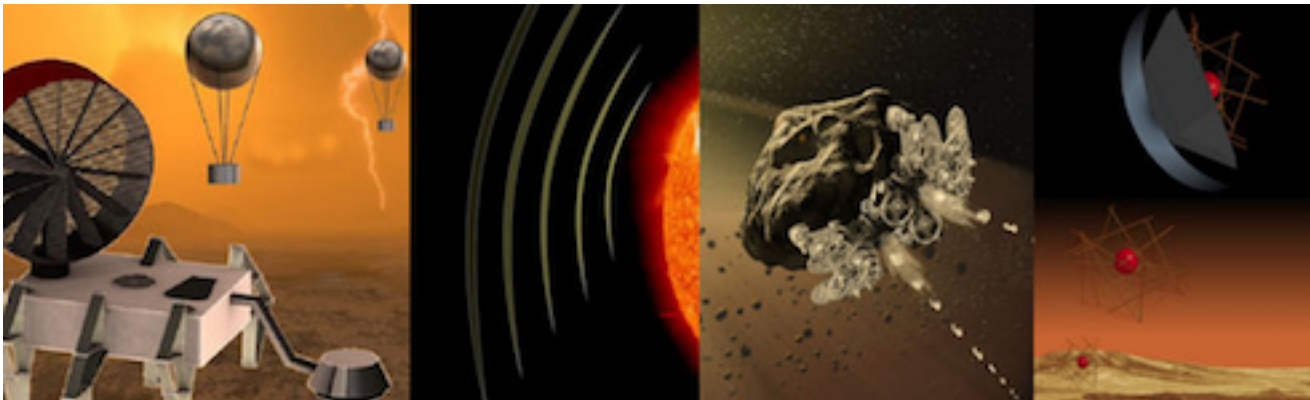

The NIAC 2016 projects, including the spacecraft and microorganisms are:

1. **Light Weight Multifunctional Planetary Probe for Extreme Environment Exploration and Locomotion**, Javid Bayandor, Virginia Polytechnic Institute and State University in Blacksburg;
2. **Venus Interior Probe Using In-situ Power and Propulsion(VIP-INSPIR)**, Ratnakumar Bugga, NASA's Jet Propulsion Laboratory (JPL) in Pasadena, California;
3. **Project RAMA: Reconstituting Asteroids into Mechanical Automata**, Jason Dunn, Made In Space, Inc. in Moffett Field, California;
4. **Molecular Composition Analysis of Distant Targets**, Gary Hughes, California Polytechnic State University, San Luis Obispo;
5. **Brane Craft**, Siegfried Janson, The Aerospace Corporation, Los Angeles;
6. **Stellar Echo Imaging of Exoplanets**, Chris Mann, Nanohmics, Inc. in Austin, Texas;
7. **Mars Molniya Orbit Atmospheric Resource Mining**, Robert Mueller, Kennedy Space Center, Florida;
8. **strong>Journey to the Center of Icy Moons**, Masahiro Ono, JPL;
9. **E-Glider: Active Electrostatic Flight for Airless Body Exploration**, Marco Quadrelli, JPL;

10. **Urban biomining meets printable electronics: end-to-end destination biological recycling and reprinting**, Lynn Rothschild, NASA's Ames Research Center in Moffett Field, California;
11. **Automaton Rover for Extreme Environments**, Jonathan Sauder, JPL;
12. **Fusion-Enabled Pluto Orbiter and Lander**, Stephanie Thomas, Princeton Satellite Systems, Inc. in Plainsboro Township, New Jersey;
13. **NIMPH- Nano Icy Moons Propellant Harvester**, Michael VanWoerkom, ExoTerra Resource, LLC. ##

## How 3D Printing Will 'Rock the World' — and Space - Book Review

10 June, 2016 - [www.space.com/33130-3d-printing-rock-world-author-interview.html](http://www.space.com/33130-3d-printing-rock-world-author-interview.html)



**Three-dimensional printing**, also called **rapid prototyping**, has finally started to go mainstream. Companies like MakerBot create home versions of machines that use computerized blueprints and extruded plastic to make objects, which were once limited to design firms.

**In space, the ability to 3D-print parts would mean that a longer mission could avoid carrying spares, instead bringing only the raw materials. This would make repairs and experimentation much easier.** ##

## 3D Printing Human Organs In Space? Microgravity Test Successful | Video

[www.space.com/33234-3d-printing-human-organs-in-space-microgravity-test-successful-video.html](http://www.space.com/33234-3d-printing-human-organs-in-space-microgravity-test-successful-video.html) - 21 June, 2016 -

For the first time, cardiac and vascular structures were 3D printed in a microgravity environment using adult human stem cells. Three companies led by NASA contractor Techshot Inc. developed a "space hardened 3D bioprinter" prototype to accomplish the feat aboard a Zero-G parabolic flight. The benefits of printing in microgravity include the use of lower viscosity bio-inks and more.

## SPACE DEBRIS PROBLEM

### NASA invests in 2D spacecraft

[www.spacedaily.com/reports/NASA\\_Invests\\_in\\_Two\\_Dimensional\\_Spacecraft\\_Reprogrammable\\_Microorganisms\\_999.html](http://www.spacedaily.com/reports/NASA_Invests_in_Two_Dimensional_Spacecraft_Reprogrammable_Microorganisms_999.html)

12 April, 2016 - Among 13 proposals through NASA Innovative Advanced Concepts (NIAC), a program that invests in transformative architectures through the development of pioneering technologies, is one that addresses Earth's growing space debris problem, **a two-dimensional spacecraft with ultra-thin subsystems that may wrap around space debris to enable de-orbiting.**

## What Happens When the Sky Starts to Fall?

[http://tasmaniantimes.com/index.php?/weblog/article/what-happens-when-the-sky-starts-to-fall/show\\_comments/](http://tasmaniantimes.com/index.php?/weblog/article/what-happens-when-the-sky-starts-to-fall/show_comments/) 25 June, 2016 - by Kim Pearl

## Astroscale: a company that seeks profit from Debris Removal

<http://astroscale.com>

**Astroscale's mission** is to actively contribute to the sustainable use of the space environment

ASTROSCALE is a **Singapore-based satellite services company** that was founded in 2013 with the objective of developing innovative solutions against the growing number of space debris. The company's mission is to actively contribute to the sustainable use of the space environment by developing scalable and innovative on-orbit technologies, in order to safely remove the most threatening debris in orbit. On top of spacecraft debris removal technologies, Astroscale is invested in providing debris monitoring and tracking capabilities. It is conducting accurate research to collect essential data on small-sized debris that cannot be tracked using the existing ground-based technologies. With its headquarters located in downtown Singapore along with its manufacturing facility in Tokyo, the company is actively preparing for its first two missions, IDEA OSG 1 and ADRAS 1.

**Astroscale's mission is to actively contribute to the sustainable use of the space environment**

- Raise awareness about space environment issues
- Craft innovative and reliable on-orbit technologies to safely remove the most threatening space debris and service existing satellites
- Improve global knowledge about small-size debris that cannot be tracked using existing technologies

## INTERNATIONAL SPACE STATION

### Bigelow Aerospace & United Launch Alliance push "Sustainable" LEO Commercialization

11 April, 2016 - [www.spacedaily.com/reports/prnewswire-space-news.html](http://www.spacedaily.com/reports/prnewswire-space-news.html)

**First-ever commercial partnership between a launch provider and a habitat provider.**



Bigelow Aerospace (BA) and United Launch Alliance (ULA) announced they are partnering to develop and deploy habitable volumes in Low Earth Orbit (LEO).

The volumes will be based on the **Bigelow Aerospace B330 expandable module** with the **initial launch to orbit in 2020** on ULA's Atlas V 552 configuration launch vehicle.

The B330 will have 330 cubic meters (12,000 cu ft) of internal space. The craft will support zero-gravity research including scientific missions and manufacturing processes.

Beyond its industrial and scientific purposes, however, it has potential as a destination for space tourism and a craft for missions destined for the Moon and Mars. ## **Editor: At long last!**

### "Expanding" the Space Station Market

18 April, 2016 - <http://www.thespacereview.com/article/2967/1> - By Jeff Foust

"Inflatables make you think of things like balloons that don't have a structure in and of themselves, that's why we prefer the term "expandable".

BEAM could later be used for commercial applications as well. "We have, actually, four different groups today that want to fly experiments and different payloads to BEAM, and deploy those within BEAM," Robert Bigelow said. Two of the groups represent countries and the other two corporations,

Past TTSIQ issues are online at: [www.moonsociety.org/international/ttsiq/](http://www.moonsociety.org/international/ttsiq/) and at: [www.nss.org/tothestars/](http://www.nss.org/tothestars/)

although he did not specifically name any of them. “We’re hoping that, maybe in half a year or something, we can get permission from NASA to accommodate these people in some way.”



just three days after the launch of BEAM, Bigelow Aerospace and United Launch Alliance announced a partnership where the two companies will work together, an effort that could eventually lead to the launch of larger Bigelow modules on ULA’s Atlas 5. ##

## The BEAM Inflatable module arrives at International Space Station

[www.spacedaily.com/reports/SpaceX\\_cargo\\_arrives\\_at\\_crowded\\_space\\_station\\_999.html](http://www.spacedaily.com/reports/SpaceX_cargo_arrives_at_crowded_space_station_999.html)

[www.space.com/32528-spacex-dragon-delivers-inflatable-room-space-station.html](http://www.space.com/32528-spacex-dragon-delivers-inflatable-room-space-station.html)

<http://phys.org/news/2016-04-spacex-world-inflatable-room-astronauts.html> – more pix

10 April, 2016 – Finally! “The BEAM inflatable habitat module is **not scheduled for use until the end of May**, but will stay at the ISS for two years so astronauts can test how it stands up to space debris and solar radiation.”

The module can expand to about 3 m (10 ft) in diameter by 4m (13 ft) long. Astronauts plan to enter the room “for a few hours several times a year to retrieve sensor data and assess conditions. “

## Inflatable Beam Module attached to the International Space Station

<http://phys.org/news/2016-04-space-station-inflatable-room-cosmic.html>

<http://bigelowaerospace.com/beam/> – video of installation to ISS

[https://en.wikipedia.org/wiki/Bigelow\\_Expandable\\_Activity\\_Module](https://en.wikipedia.org/wiki/Bigelow_Expandable_Activity_Module)

[www.space.com/32600-beam-experimental-inflatable-room-space-station.html](http://www.space.com/32600-beam-experimental-inflatable-room-space-station.html)

10–16 April, 2016 – Finally! “The BEAM inflatable habitat module is **not scheduled for use until the end of May**, but will stay at the ISS for two years so astronauts can test how it stands up to space debris and solar radiation.”

The module can expand to about 3 m (10 ft) in diameter by 4m (13 ft) long.

Astronauts plan to enter the room “for a few hours – several times a years to retrieve sensor data and assess conditions.”

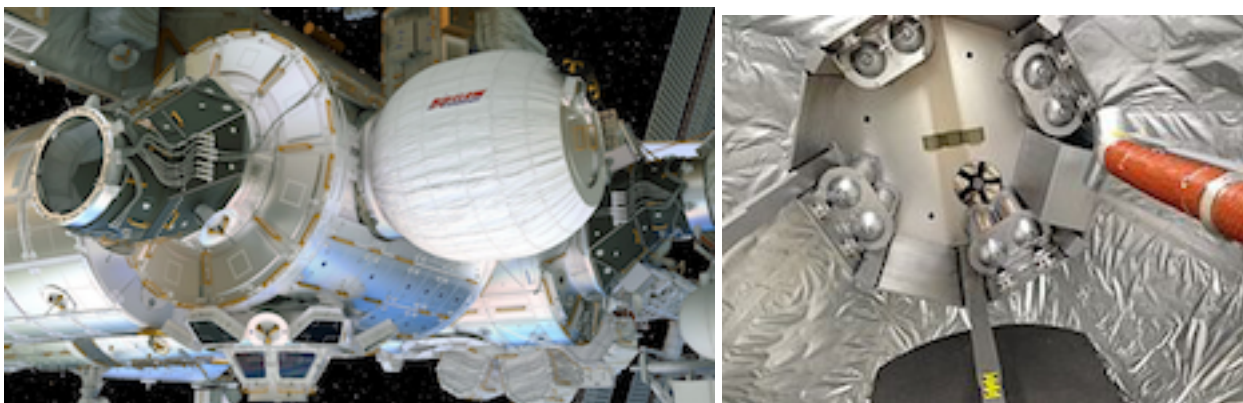

View of inflated BEAM module from outside (left) and inside (right)

BEAM could "change the entire dynamic for human habitation" in space. "Companies— even countries—are clamoring to put their own experiments inside the empty BEAM.

**That next commercial step could happen in perhaps six months"** – Robert Bigelow

BEAM has been bundled up for more than a year—it should have flown last fall, but was delayed by the SpaceX rocket grounding. Bigelow stresses that **the main purpose is testing** and engineers don't know now how well it will work after being compressed for so long. – Keep your fingers crossed!

After two years, BEAM will be cut loose, eventually burning up on re-entry. ##

**Editor:** a larger inflatable would have allowed astronauts to experiment with recreational activities inside, bouncing off walls etc. (sports, dancing, "space ballet?") etc. But none of the vehicles now able to supply the station have the capacity to carry a bigger unit, and if that were not the case, NASA does not have a high enough level of the "right stuff" to have made a decision to use a larger unit, or the foresight to pay the added transport price. . **But this is a welcome start in the right direction. PK ##**

## NASA Hits Snag While Inflating Space Station's New BEAM Habitat

26 May, 2016 – [www.space.com/32999-nasa-inflatable-space-station-room-snag.html](http://www.space.com/32999-nasa-inflatable-space-station-room-snag.html)

[www.space.com/32998-bigelow-module-on-space-station-fails-to-deploy-on-first-try-video.html](http://www.space.com/32998-bigelow-module-on-space-station-fails-to-deploy-on-first-try-video.html)



When NASA astronaut Jeff Williams began the inflation process for BEAM on the ISS early the morning of May 26th, the module did not expand as expected, forcing flight controllers to call off the attempt for the day. ##

## 1st Inflatable Habitat for Astronauts All Pumped Up on Space Station

28 May, 2016 – [www.space.com/32992-beam-inflatable-space-habitat-success.html](http://www.space.com/32992-beam-inflatable-space-habitat-success.html)

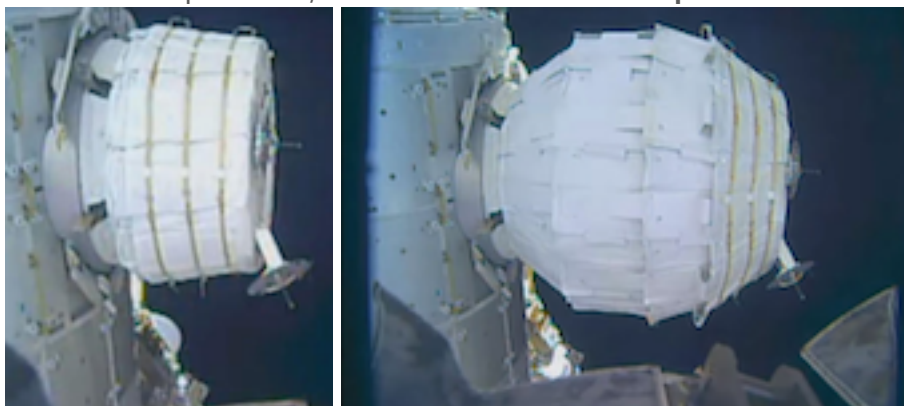

**Left:** Previous inflation stalled state – **Right:** Inflation complete

28 may, 2016 – It took an astronaut more than seven hours to inflate the privately built Bigelow Expandable Activity Module (BEAM) on May 28. The new space room was built for NASA by Bigelow Aerospace. Its inflation went at a glacial pace — a safety precaution since BEAM is the first of its

kind — with reports of popping noises with almost every short burst of air he fed into the module through a manual valve.

BEAM had barely expanded during the first inflation attempt. The soft-sided compartment was packed up tight for so long before its launch that the fabric layers may have had trouble unfolding.

This time, an astronaut spent seven hours opening and closing an air valve to expand the compartment. Enough air finally seeped inside so that the puffy white pod could stretch to its full 13 feet in length and 10 ½ feet in diameter. Internal air tanks provided the final pressurization to complete the job. Crewmates will have to wait a week before venturing inside. NASA wants to make certain the chamber is airtight before opening the door. **## 3 cheers!**

**Editor:** *The lesson for both Bigelow & NASA? Do a test inflation on the ground before loading for launch.*

## Astronauts enter world's first inflatable space habitat (Update)

5 June, 2016 - <http://phys.org/news/2016-06-astronauts-world-inflatable-space-lodge.html>



In this image from video provided by NASA, NASA astronaut Jeff Williams floats inside the Bigelow Expandable Activity Module (BEAM) Monday, June 6, 2016.

## New Virtual Tour Lets You Explore the International Space Station

14 June, 2016 - [www.space.com/33164-virtual-tour-of-space-station.html](http://www.space.com/33164-virtual-tour-of-space-station.html)

Very few people get to fly to low Earth orbit, let alone live there. But now, the rest of us can enjoy a simulation of the experience, thanks to a new virtual tour of the Station by the European Space Agency.

Available in English, French, German, Italian, Spanish and Dutch — the narrated video takes the viewer on an end-to-end journey through the station, inside and out. Americans may particularly enjoy a close look at the Russian side of the space station, which is rarely featured in NASA photos. **##**

## Space Station's Commercial 3D Printer Makes Its 1st Tool (Photos)

[www.space.com/33166-space-station-commercial-3d-printer-first-tool-photos.html?utm\\_source=feedburner](http://www.space.com/33166-space-station-commercial-3d-printer-first-tool-photos.html?utm_source=feedburner) - 14 June, 2016 - The first commercial 3D printer in space is up and running.



The wrench was made with a special off-Earth feature — a fastening clip that should help astronauts keep track of the tool in zero g. Known as the Additive Manufacturing Facility (AMF), it was installed aboard the Station in late April. And last week, it printed out **its first tool** — a wrench that astronauts can use to do maintenance work aboard the orbiting lab.

The wrench was made with a special off-Earth feature — a fastening clip that should help astronauts keep track of the tool in zero g.

## China on schedule for launch this year of 2nd space station

26 June, 2016 – <http://phys.org/news/2016-06-china-year-space-station.html>



China recovered an experimental probe launched aboard a new generation rocket, a new milestone. The spaceship's landing on the Mongolian steppe keeps China on schedule to place its 2nd space station in orbit later this year. The launch of the spaceship was the new Long March 7 rocket' ##

## NASA TECHNOLOGY EFFORTS

### From 'Magnetoshells' to Growable Habitats, NASA Invests in Next Stage of Visionary Technology Development

[www.nasa.gov/press-release/from-magnetoshells-to-growable-habitats-nasa-invests-in-next-stage-of-visionary](http://www.nasa.gov/press-release/from-magnetoshells-to-growable-habitats-nasa-invests-in-next-stage-of-visionary)

13 May, 2016 – NASA has selected eight technology proposals for investment that have the potential to transform future aerospace missions, introduce new capabilities, and significantly improve current approaches to building and operating aerospace systems.

NASA selected these projects through a peer-review process that evaluated innovativeness and technical viability. The selected concepts are:

- **Advancing Torpor Inducing Transfer Habitats for Human Stasis to Mars**, John Bradford, Space Works, Inc. in Atlanta
- **Cryogenic Selective Surfaces**, Robert Youngquist, Kennedy Space Center in Florida
- **Directed Energy Interstellar Study**, Philip Lubin, University of California, Santa Barbara
- **Experimental Demonstration and System Analysis for Plasmonic Force Propulsion**, Joshua Rovey, University of Missouri in Rolla
- **Flight Demonstration of Novel Atmospheric Satellite Concept**, William Engblom, Embry-Riddle Aeronautical University in Daytona Beach, Florida
- **Further Development of Aperture: A Precise Extremely Large Reflective Telescope Using Re-configurable Elements**, Melville Ulmer, Northwestern University in Evanston, Illinois
- **Magnetoshell Aerocapture for Manned Missions and Planetary Deep Space Orbiters**, David Kirtley, MSNW, LLC in Redmond, Washington
- **Tensegrity Approaches to In-Space Construction of a 1g Growable Habitat**, Robert Skelton, Texas Engineering Experiment Station in La Jolla, California ##

Past TTSIQ issues are online at: [www.moonsociety.org/international/ttsiq/](http://www.moonsociety.org/international/ttsiq/) and at: [www.nss.org/tothestars/](http://www.nss.org/tothestars/)



## NASA Works to Improve Solar Electric Propulsion for Deep Space Exploration Latest Developments in Solar Electric Propulsion for Future Deep Space Exploration

[www.nasa.gov/press-release/nasa-works-to-improve-solar-electric-propulsion-for-deep-space-exploration](http://www.nasa.gov/press-release/nasa-works-to-improve-solar-electric-propulsion-for-deep-space-exploration)

[www.nasa.gov/press-release/nasa-to-discuss-latest-developments-in-solar-electric-propulsion-for-future-deep-space](http://www.nasa.gov/press-release/nasa-to-discuss-latest-developments-in-solar-electric-propulsion-for-future-deep-space) - 19 April, 2016

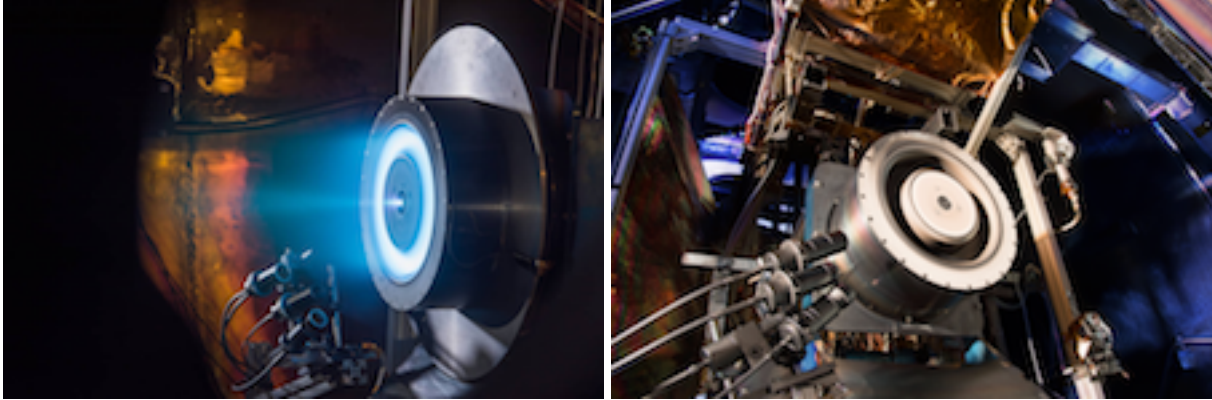

**Left:** a prototype 13-kilowatt Hall thruster during testing at NASA's Glenn Research Center in Cleveland. This prototype demonstrated the technology readiness needed for industry to continue the development of high-power solar electric propulsion into a flight-qualified system.

**Right:** Hall thrusters trap electrons in a magnetic field and use them to ionize the onboard propellant. It uses **10 times less propellant than equivalent chemical rockets** ##

## Next-Gen Propulsion System Gets \$67 Million from NASA

26 April, 2016 - [www.space.com/32692-solar-electric-propulsion-asteroid-mars.html](http://www.space.com/32692-solar-electric-propulsion-asteroid-mars.html)

NASA has awarded California-based company Aerojet Rocketdyne a \$67 million, 36-month contract to design, build and test an advanced, superefficient **solar-electric propulsion (SEP)** system. These new engines should have a profound impact on the future of spaceflight. ##

## 100,000 Orbits! Space Station Milestone Tribute To Human Ingenuity Video

[www.space.com/32885-100-000-orbits-space-station-milestone-is-tribute-to-human-ingenuity-video.html](http://www.space.com/32885-100-000-orbits-space-station-milestone-is-tribute-to-human-ingenuity-video.html) - 16 May, 2016



From



to

kudos!

Since the first component of the International Space Station (ISS) was launched on Nov. 20, 1998, the station has flown 2,643,342,240 miles. On May 16, 2016 it officially have surpassed **100,000 orbits of Earth**. ##

**EDITOR:** Kudos to NASA and to all the astronauts who have worked on the station!

## INTERNATIONAL COOPERATION

**NASA, UAE Sign Significant Outer Space, Aeronautics Cooperation Agreement**

[www.nasa.gov/press-release/nasa-uae-sign-significant-outer-space-aeronautics-cooperation-agreement](http://www.nasa.gov/press-release/nasa-uae-sign-significant-outer-space-aeronautics-cooperation-agreement)

12 June, 2016 – The United States and United Arab Emirates (UAE) have entered into an agreement to cooperate in aeronautics research, and the exploration and use of airspace and outer space for peaceful purposes, working together in the peaceful use of outer space for the benefit of humanity.

“NASA is leading an ambitious journey to Mars that includes partnerships with the private sector and many international partners, The UAE Space Agency will help advance this journey, as well as other endeavors in the peaceful exploration of outer space.”

Technical experts from our two countries are engaged in discussions on several areas of mutual interest, and I believe our two agencies will collaborate for years to come through a common interest in aeronautics, exploration and discovery.” ##

## MISSION TO PLANET EARTH

**This Underwater Hotel Wants To Lead The Way In Restoring Reefs**

[www.huffingtonpost.com/entry/underwater-hotel-restoring-reefs\\_us\\_56dd9e05e4b03a4056792891](http://www.huffingtonpost.com/entry/underwater-hotel-restoring-reefs_us_56dd9e05e4b03a4056792891)  
<http://www.planetooceanunderwaterhotel.com>

11 March, 1016 – “Inner Space Tourism” A “Space Hotel” underwater!

**Planet Ocean Underwater Hotel – “inner space tourism”**

When it comes to the future of travel, many experts have looked beyond Earth to the cosmos. But it turns out there’s another trend that’s quietly making waves on our home planet, targeting destinations beneath the sea instead of above the sky: underwater hotels.

The architectural similarity to some proposed space hotels is clear. But this one comes with gravity, and a less-expensive room rate! You can visit near Key West, Florida.

For most of us, this is as close as we might get to pretending to a guest in a real space hotel! ##

## Moon thought to play a major role in maintaining Earth's magnetic field

[www.space-travel.com/reports/The\\_Moon\\_thought\\_to\\_play\\_a\\_major\\_role\\_in\\_maintaining\\_Earths\\_magnetic\\_field\\_999.html](http://www.space-travel.com/reports/The_Moon_thought_to_play_a_major_role_in_maintaining_Earths_magnetic_field_999.html)

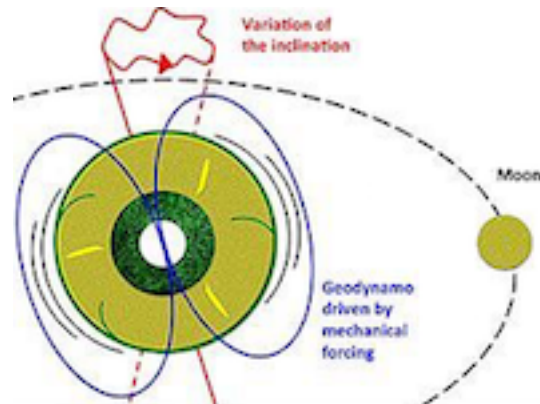

1 April, 2016 – The gravitational effects associated with the presence of the Moon and Sun cause cyclical deformation of the Earth's mantle and wobbles in its rotation axis. This mechanical forcing applied to the whole planet causes strong currents in the outer core, which is made up of a liquid iron alloy of very low viscosity. Such currents are enough to generate the Earth's magnetic field.

**(Editor:** Given the protection Earth's magnetic field gives us - the Van Allen Belts - this could mean that otherwise Earthlike planets - Hydrotectonic, i.e. with "active tectonic processes in the presence of water, i.e. possessing **continents and oceans** - but without a sizable moon - might not support life as Earth does.

**That might make worlds like ours even more rare and special than previously thought.**

**Perhaps we should start thinking of our home world as "an integral pair", "Earth-Moon", "Terra-Luna" [Latin], "Gaia-Selene" {Greek} - PK)**

## India: The Future King of Sovereign Solar

6 April, 2016 – [www.solardaily.com/reports/India\\_The\\_Future\\_King\\_of\\_Sovereign\\_Solar\\_999.html](http://www.solardaily.com/reports/India_The_Future_King_of_Sovereign_Solar_999.html)



**Basking in sunshine for an average of 300 days every year**, the Republic of India may be set to become the eventual champion of solar power producing nations. Experts have put the nation's theoretical solar electricity output from land sources alone at some **5,000 trillion kilowatt-hours annually, the largest sovereign potential in the world.**

The state of Tamil Nadu on India's southern tip had set an ambitious goal to boost its installed solar capacity by 15-fold to over 3,000 megawatts by 2015. ##

**Editor:** that's if continuing human activity induced climate change doesn't reduce India's "time in the sun."

## 6–10 million years ago: Ice-free Summers at the North Pole

[www.spacedaily.com/reports/Six\\_to\\_10\\_million\\_years\\_ago\\_Ice\\_free\\_summers\\_at\\_the\\_North\\_Pole\\_999.html](http://www.spacedaily.com/reports/Six_to_10_million_years_ago_Ice_free_summers_at_the_North_Pole_999.html)

8 April, 2016 – Using unique sediment samples from the Lomonosov Ridge, the researchers found that six to ten million years ago the central Arctic was completely ice-free during summer and sea-surface temperature reached values of 4 to 9 degrees Celsius.

In spring, autumn and winter, however, the ocean was covered by sea ice of variable extent, ##

## Possible Viking settlement found using 'space archaeology'

[www.aol.com/article/2016/04/01/possible-viking-settlement-found-using-space-archaeology/21336743/](http://www.aol.com/article/2016/04/01/possible-viking-settlement-found-using-space-archaeology/21336743/)

1 April, 2016 – Archaeologists think they have discovered the second-known Viking settlement in North America. Using satellite images, scientists identified changes in the landscape that suggested there might be something beneath the surface. The only other known Viking settlement in North America is in Newfoundland, Canada. This one is 300 miles further inland at Point Rosee.

Archaeologists discovered a fire-cracked stone and pieces of cooked iron at the new site, though they still need to do further research to confirm this is a Viking settlement. There's only one other known iron processing site in North America that existed before Europeans arrived on the continent – the one from the first Viking site discovered. ##

## 'Climate-smart soils' may help balance the carbon budget

[www.seeddaily.com/reports/Climate\\_smart\\_soils\\_may\\_help\\_balance\\_the\\_carbon\\_budget\\_999.html](http://www.seeddaily.com/reports/Climate_smart_soils_may_help_balance_the_carbon_budget_999.html)

["Climate-smart Soils," published in *Nature*, April 6, 2016]

8 April, 2016 – **We can substantially reduce atmospheric carbon by using soil.**

While farm soil grows the world's food and fiber, scientists are examining ways to use it to sequester carbon and mitigate greenhouse gas emissions.

“using prudent agricultural management practices that tighten the soil-nitrogen cycle can yield enhanced soil fertility, bolster crop productivity, improve soil biodiversity, and reduce erosion, runoff and water pollution. These practices also buffer crop and pasture systems against the impacts of climate change.”

## Supernovae showered Earth with radioactive debris

[www.spacedaily.com/reports/Supernovae\\_showered\\_Earth\\_with\\_radioactive\\_debris\\_999.html](http://www.spacedaily.com/reports/Supernovae_showered_Earth_with_radioactive_debris_999.html)

<http://phys.org/news/2016-04-proof-ancient-supernovae-zapped-earth.html>

9 April, 2016 – An international team of scientists has found evidence of a series of massive supernova explosions near our solar system, which showered the Earth with radioactive debris.

The scientists found radioactive iron-60 in sediment and crust samples taken from the Pacific, Atlantic and Indian Oceans.

The iron-60 was concentrated in a period **between 3.2 and 1.7 million years ago**, spread across 1.5 million years, when the Earth cooled and moved from the Pliocene into the Pleistocene period, **relatively recent** in astronomical terms

The supernovas in this case were less than 300 light years away, close enough to be visible during the day and about as bright as the Moon.

Although Earth would have been exposed to an increased cosmic ray bombardment, the radiation would have been too weak to cause direct biological damage or trigger mass extinctions. ##

## Earth Is 'A Beautiful Planet' And 'We Are Changing It' – IMAX Film Clip

[www.space.com/32653-earth-is-a-beautiful-planet-and-we-are-changing-it-imax-film-clip.html](http://www.space.com/32653-earth-is-a-beautiful-planet-and-we-are-changing-it-imax-film-clip.html)

## Extreme weather linked to high pressure over Greenland

[www.spacedaily.com/reports/Climate\\_change\\_and\\_extreme\\_weather\\_linked\\_to\\_high\\_pressure\\_over\\_Greenland\\_999.html](http://www.spacedaily.com/reports/Climate_change_and_extreme_weather_linked_to_high_pressure_over_Greenland_999.html)



3 May, 2016 – New research has identified changes in weather systems over Greenland that have dragged unusually warm air up over the western flank of Greenland's Ice Sheet.

These weather systems are also linked to extreme weather patterns over northwest Europe, such as the unusually wet conditions in the UK in the summers of 2007 and 2012. ##

## Atmosphere of Early Earth May Have Been Half As Thick As Today

11 May, 2016 – [www.space.com/32858-early-earth-atmosphere-was-half-as-thick.html](http://www.space.com/32858-early-earth-atmosphere-was-half-as-thick.html)

Bubbles in ancient Australian lava reveal that the early Earth's atmosphere might have been half as thick as it is today. ##

## Cosmic Dust on Earth Reveals Clues to Ancient Atmosphere

12 May, 2016 – [www.space.com/32859-space-dust-reveals-clues-ancient-earth-atmosphere.html](http://www.space.com/32859-space-dust-reveals-clues-ancient-earth-atmosphere.html)

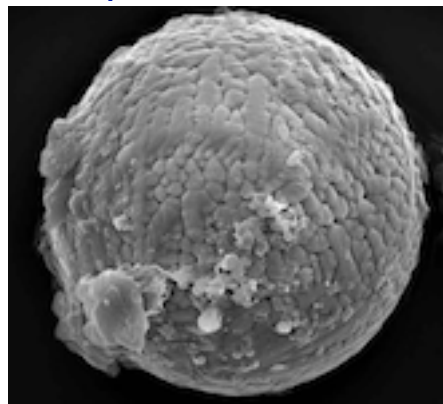

One of 60 micrometeorites extracted from 2.7-billion-year-old limestone, from the Pilbara region in Western Australia. These micrometeorites consist of iron oxide minerals that formed when dust particles of meteoritic iron metal were oxidised as they entered Earth's atmosphere, indicating that the ancient upper atmosphere was surprisingly oxygen rich. ##

## Volcanic Ash Clouds tracked by satellite to keep planes flying safely

[www.space.com/32884-volcanic-ash-clouds-tracked-by-satellite-to-keep-planes-flying-video.html](http://www.space.com/32884-volcanic-ash-clouds-tracked-by-satellite-to-keep-planes-flying-video.html)

## NASA Satellite Finds Unreported Sources of Toxic Air Pollution

[www.nasa.gov/press-release/nasa-satellite-finds-unreported-sources-of-toxic-air-pollution](http://www.nasa.gov/press-release/nasa-satellite-finds-unreported-sources-of-toxic-air-pollution)

1 June– 2016 = Using a new satellite-based method, scientists at NASA, Environment and Climate Change Canada, and two universities have located 39 unreported and major human-made sources of toxic sulfur dioxide emissions.

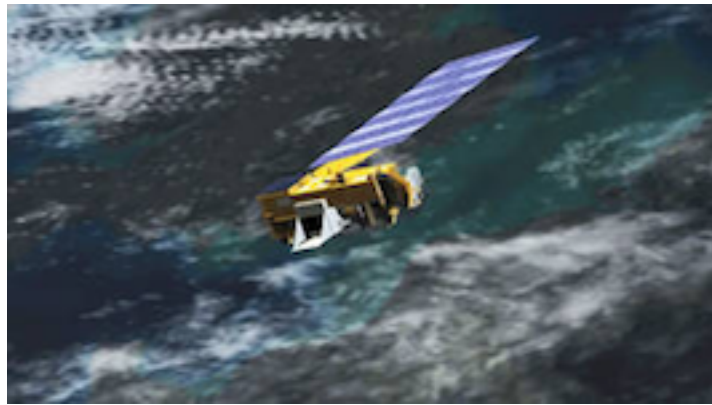

Data from NASA's Aura spacecraft, illustrated here, were analyzed by scientists to produce improved estimates of sulfur dioxide sources and concentrations worldwide between 2005 and 2014.

"We now have an independent measurement of these emission sources that does not rely on what was known or thought known. When you look at a satellite picture of sulfur dioxide, you end up with it appearing as hotspots – bull's-eyes, in effect -- which makes the estimates of emissions easier." ##

### Study finds link between 2015 melting Greenland ice, faster Arctic warming

[www.spacedaily.com/reports/Study\\_finds\\_link\\_between\\_2015\\_melting\\_Greenland\\_ice\\_faster\\_Arctic\\_warming\\_999.html](http://www.spacedaily.com/reports/Study_finds_link_between_2015_melting_Greenland_ice_faster_Arctic_warming_999.html)

10 June 2016 = A new study provides the first evidence that links melting ice in Greenland to a phenomenon known as Arctic amplification – faster warming of the Arctic compared to the rest of the Northern Hemisphere as sea ice disappears.

The findings show that the predicted effects of Arctic amplification, as described in previous studies, occurred over northern Greenland during summer 2015, including a northern swing of the jet stream that reached latitudes never before recorded in Greenland at that time of year. ##

### Thanks to climate change, the Arctic is turning green

[www.washingtonpost.com/news/energy-environment/wp/2016/06/27/its-official-humans-are-making-the-earth-much-greener/](http://www.washingtonpost.com/news/energy-environment/wp/2016/06/27/its-official-humans-are-making-the-earth-much-greener/)



27 June, 2016 – Using 29 years of data from Landsat satellites, researchers at NASA have found extensive greening in the vegetation across Alaska and Canada. Rapidly increasing temperatures in the Arctic have led to longer growing seasons and changing soil for plants. ##



## NEAR SPACE & SPACE TOURISM

### **Moon-themed hotel, once eyed for Las Vegas, lands in Coachella Valley, CA.**

<http://lasvegassun.com/vegasdeluxe/2016/feb/08/moon-themed-hotel-once-eyed-for-lv-lands-coachella/>

6 February, 2016 – The \$4 billion, 4,000 all-suite, 5-star lunar-themed Moon World Resorts that once looked for space in Las Vegas has landed in Coachella Valley in California, with its opening date targeted for 2022 after two years of permit and entitlement processes and a 48-month build-out.

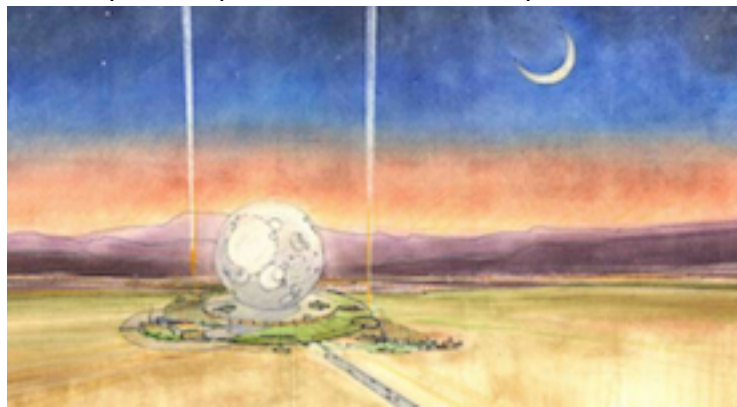

Artist rendering of the 10 million square foot (929,000 sq. m.) project



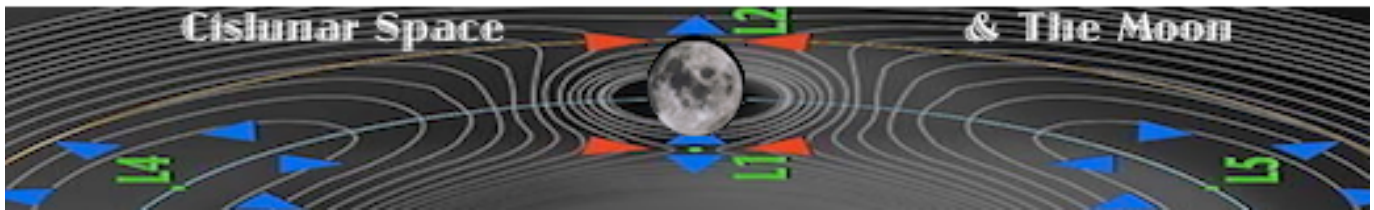

We insist on capitalizing “Moon” when it refers to Earth’s satellite.  
Read why: <http://www.moonsociety.org/info/capital-M-for-Moon.html>

## MOON SCIENCE

**The Moon thought to play a major role in maintaining Earth's magnetic field**  
[www.space-travel.com/reports/The\\_Moon\\_thought\\_to\\_play\\_a\\_major\\_role\\_in\\_maintaining\\_Earths\\_magnetic\\_field\\_999.html](http://www.space-travel.com/reports/The_Moon_thought_to_play_a_major_role_in_maintaining_Earths_magnetic_field_999.html)

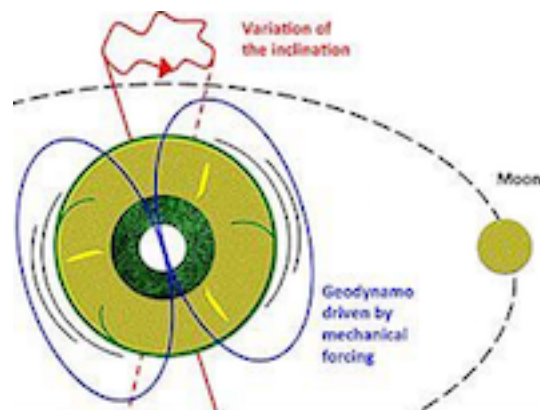

1 April, 2016 – The gravitational effects associated with the presence of the Moon and Sun cause cyclical deformation of the Earth's mantle and wobbles in its rotation axis. This mechanical forcing applied to the whole planet causes strong currents in the outer core, which is made up of a liquid iron alloy of very low viscosity. Such currents are enough to generate the Earth's magnetic field.

*(Editor: Given the protection Earth's magnetic field gives us - the Van Allen Belts - this could mean that otherwise Earthlike planets - Hydrotectonic, with "active tectonic processes in the presence of water, i.e. Possessing continents and oceans - but without a sizable moon - might not support life as Earth does.*

*That might make worlds like ours even more rare and special than previously thought.*

*Perhaps we should start thinking of our home world as "an integral pair", "Earth-Moon", "Terra-Luna" [Latin], "Gaia-Selene" {Greek} - PK)*

## GRAIL data points to possible Lava Tubes on the Moon

5 April, 2016 – [www.universetoday.com/128208/buried-lava-tubes/](http://www.universetoday.com/128208/buried-lava-tubes/)

For years, scientists have been hunting for the stable lava tubes that are believed to exist on the Moon. A remnant from the Moon's past, when it was still volcanically active, these underground channels could very well be an ideal location for lunar colonies someday. Not only would their thick roofs provide naturally shielding from solar radiation, meteoric impacts, and extremes in temperature. They could also be pressurized to create a breathable environment.

But until now, evidence of their existence has been inferred from surface features such as sinuous rilles – channel-like depressions that run along the surface that indicate the presence of subterranean lava flows – and holes in the surface (aka. "skylights").

Recent evidence presented at the 47<sup>th</sup> Lunar and Planetary Science Conference (LPSC) in Texas indicates that one such stable lava tube could exist in the once-active region known as Marius Hills.



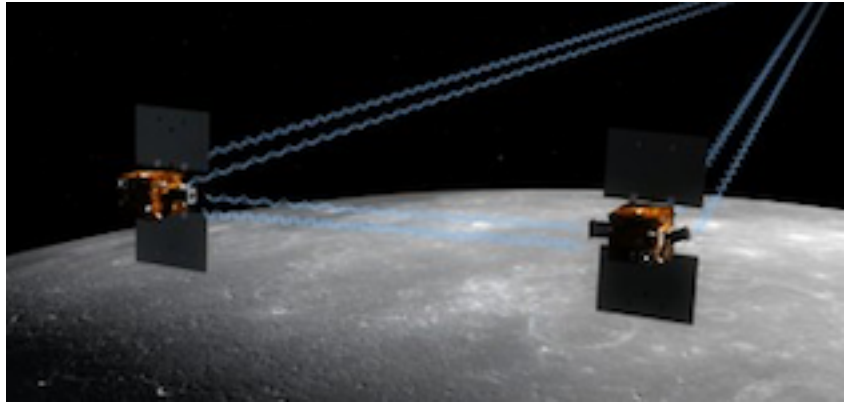
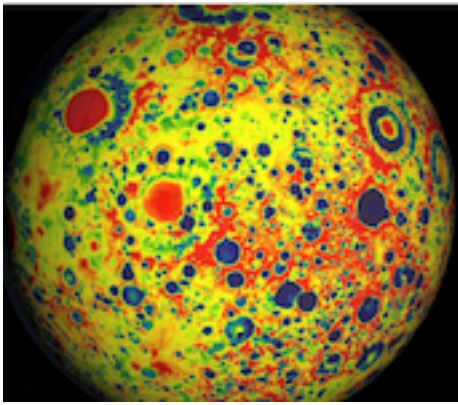

**Left:** Map showing variations in the lunar gravity field, as measured by NASA's Gravity Recovery and Interior Laboratory (GRAIL) twin orbiters, Ebb and Flow (**Right**).

Examining data obtained from NASA's twin **Gravity Recovery and Interior Laboratory (GRAIL)** orbiters, dubbed Ebb and Flow, gives us a better sense of what the Moon's interior looks like.

Over time, the information gathered has provided us with the opportunity to better understand the Moon's subsurface features, particularly the buried lava tubes believed to exist.

Using the GRAIL gravity data that was collected at different altitudes, the team could assess the presence and extent of ancient lava tubes beneath the surface of Marius Hills.

## Moon Rocks' Radioactive Iron Suggests Supernova Blasted Earth

20 April, 2016 = [www.space.com/32631-radioactive-iron-supernova-apollo-moon-rocks.html](http://www.space.com/32631-radioactive-iron-supernova-apollo-moon-rocks.html)

Radioactive iron in moon rocks collected by astronauts on NASA's Apollo missions suggests that a nearby supernova blasted Earth a few million years ago. This finding supports the idea that nearby stellar explosions may have influenced life on Earth, including the evolution of humans. ##

## The Origins of Strange Swirls on the Moon are Coming to Light

[www.space-travel.com/reports/NASA\\_research\\_gives\\_new\\_insights\\_into\\_how\\_the\\_Moon\\_got\\_inked\\_99.html](http://www.space-travel.com/reports/NASA_research_gives_new_insights_into_how_the_Moon_got_inked_99.html) - [www.space.com/32787-strange-moon-swirls-origins.html](http://www.space.com/32787-strange-moon-swirls-origins.html)



This image from NASA's Lunar Reconnaissance Orbiter shows the Reiner Gamma lunar swirl.  
4 May, 2016 - An avalanche of new research illuminates the strange swirls of light and dark peppering the surface of the moon, suggesting that the weak magnetic field Earth's only natural satellite offers a surprisingly strong shield to parts of the lunar crust. ##

## A new, water-logged history of the Moon

31 May, 2018 – [www.space-travel.com/reports/A\\_new\\_water-logged\\_history\\_of\\_the\\_Moon\\_999.html](http://www.space-travel.com/reports/A_new_water-logged_history_of_the_Moon_999.html)  
<http://phys.org/news/2016-05-water-logged-history-moon.html>

After the Apollo missions scooped up rocks from the Moon's surface and brought them home, scientists were convinced for decades that they had proof our nearest celestial neighbour was drier than a bone. How wrong they were.

New technology detected water in those dusty samples nearly a decade ago, and a new study tells us how and when that water -- lots and lots of it -- likely wound up on the Moon. In a word, asteroids.

After the Moon was born of a collision between Earth and a Mars-sized planet some 4.5 billion years ago, it was bombarded with water-rich asteroids known as carbonaceous chondrites for tens of millions of years, perhaps longer.

So was Earth, which is one reason the findings are of more than academic interest.

"The Moon can be viewed as a giant time capsule, preserving a record of the impact history of Earth and Moon since their formation," Here on Earth, that record has been largely erased by tectonic plates moving continents like pieces on a board game.

## GOOGLE LUNAR X-PRIZE – OTHER PRIVATE ENTERPRISE EFFORTS

### Private lunar mission 'seeks US approval'

6 June, 2016 – <http://phys.org/news/2016-06-private-venture-moon-mission.html>  
<http://phys.org/news/2016-06-private-venture-moon-mission.html>

The US government, in a first, is preparing to approve a private commercial space mission beyond the Earth's orbit,

The expected decision would set precedents for how the US government would ensure that private ventures comply with international space treaties,

Once the guidelines are set, the space startup **Moon Express** would embark on a mission to land a 20-pound (nine-kilo) package of scientific gear, including a telescope, on the moon sometime in the second half of 2017. ##

## HUMAN OUTPOSTS ON THE MOON

### Lunar Leap: Europe Is Reaching for a Moon Base by the 2030s

30 December, 2015 – [www.space.com/31488-european-moon-base-2030s.html](http://www.space.com/31488-european-moon-base-2030s.html)

#### "Comeback to the Moon"

There is growing interest in Europe to prioritize the Moon as humanity's next deep-space destination, and to serve as a springboard to push the human exploration of the solar system, with Mars as the horizon goal. Seeing the strategic significance of the Moon, Europe is pushing forward lunar exploration missions that would involve both humans and robots.

European space planners envision a series of human missions to the lunar vicinity starting in the early 2020s. They would include coordination between astronauts and robotic systems on the lunar surface. Robots would land first, paving the way for human explorers to set foot on the Moon. ##

### Lunar lava tubes could help pave way for human colony

[www.space-travel.com/reports/Lunar\\_Lava\\_Tubes\\_Found\\_on\\_the\\_Moon\\_Could\\_Help\\_Pave\\_Way\\_for\\_Human\\_Colony\\_999.html](http://www.space-travel.com/reports/Lunar_Lava_Tubes_Found_on_the_Moon_Could_Help_Pave_Way_for_Human_Colony_999.html)

8 April, 2016 – The announcement that at least one lava tube has been mapped in a lunar region called Marius Hills was finally made on April 7th at the 47th Lunar and Planetary Science Conference (LPSC) in Texas. Astronomers used data from NASA's Gravity Recovery and Interior Laboratory (GRAIL) – a space probe that is mapping the satellite's gravitational field variation with extreme detail.

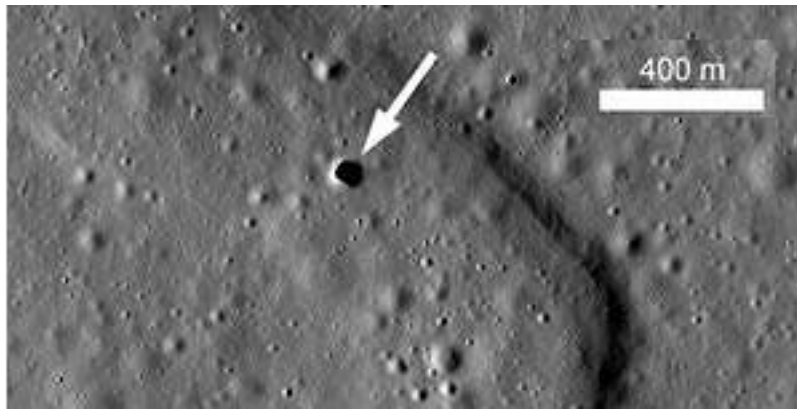

Marius hills skylight may be entry to lava tube.

By analyzing lunar gravity, the team realized that lava once ran between two rilles in the Marius region, next to a crater.

This was possible because the gravitational pull of a material is stronger the higher the material's density. When the GRAIL space probe flew over the alleged lava tube – which if hollow, would be less dense – it detected a decrease in gravitational attraction compatible with the presence of an underground cavity.

GRAIL also detected at least ten other possible "gravitational signatures" that could point to the presence of lava tubes in various regions across the Moon.

## NASA invests in e-glider technology

[www.spacedaily.com/reports/NASA\\_Invests\\_in\\_Two\\_Dimensional\\_Spacecraft\\_Reprogrammable\\_Microorganisms\\_999.html](http://www.spacedaily.com/reports/NASA_Invests_in_Two_Dimensional_Spacecraft_Reprogrammable_Microorganisms_999.html)

12 April, 2016 – Among 13 proposals through NASA Innovative Advanced Concepts (NIAC), a program that invests in transformative architectures through the development of pioneering technologies, is an “E-Glider”\_ **Active Electrostatic Flight for Airless Body Exploration**. This applies to the Moon, Mercury, asteroids, and the major moons of Jupiter and other planets. ##

## Europe Aiming for International 'Moon Village'

26 April, 2016 – [www.space.com/32695-moon-colony-european-space-agency.html](http://www.space.com/32695-moon-colony-european-space-agency.html)

This envisioned “**Moon Village**” a product of international collaboration between spacefaring nations [read **Europe, Russia and China**, as NASA seemed preoccupied with Mars], will be a base for **science, business, mining and even tourism** – and pave the way for human missions to Mars.

The term “**moon village**” was chosen advisedly, to help people understand the purpose of such an outpost. “**A village is something where different people are gathering with different capabilities, different opportunities, and then they build a community**, It’s not one village with some houses and a church. The idea is to bring together a variety of different actors from the public and private sectors.” ##  
**Recommended** by author Leonard David:

[www.space.com/21583-moon-base-lunar-colony-photos.html](http://www.space.com/21583-moon-base-lunar-colony-photos.html)

[www.space.com/27203-living-on-the-moon-explained-infographic.html](http://www.space.com/27203-living-on-the-moon-explained-infographic.html) ##

s

## European Space Agency designs drill for Ice at Moon’s South Pole

11 May, 2016 – [www.esa.int/spaceinimages/Images/2016/05/Lunar\\_ice\\_drill](http://www.esa.int/spaceinimages/Images/2016/05/Lunar_ice_drill)

A drill designed to penetrate 1–2 m into the lunar polar surface is planned by ESA to fly to the Moon’s on Russia’s Luna–27 lander in 2020, as an essential part of a science and exploration package being developed to reach, extract and analyse samples from beneath the surface. ##

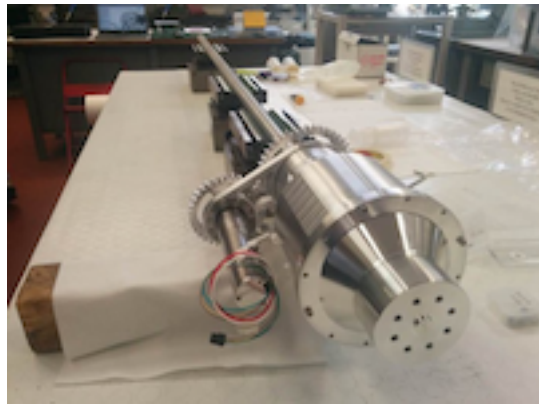

## SwRI scientists discover fresh lunar craters

24 May, 2016 – A Southwest Research Institute–led team of scientists discovered two geologically young craters – one 16 million, the other between 75 and 420 million, years old – in the Moon's darkest regions. "These 'young' impact craters are a really exciting discovery. Finding geologically young craters and honing in on their age helps us understand the collision history in the solar system."

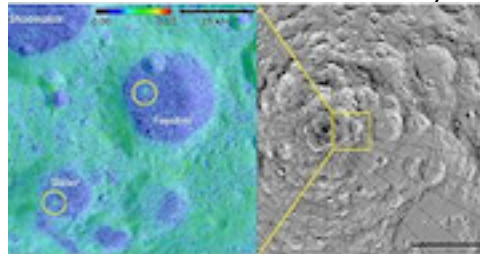

Finding geologically young craters and their age sheds lights the collision history in the solar system. ##

## Russian Firm to Develop Reusable Spacecraft for Lunar Missions

[www.space-travel.com/reports/Russian\\_Firm\\_Develops\\_Project\\_of\\_Reusable\\_Spacecraft\\_for\\_Lunar\\_Missions\\_999.html](http://www.space-travel.com/reports/Russian_Firm_Develops_Project_of_Reusable_Spacecraft_for_Lunar_Missions_999.html)



30 May, 2016 – Energia has developed a project of reusable manned Ryvok spacecraft for delivery of cargo and cosmonauts to the Moon. Energia was planning to start the construction of next-generation Federatsia (Federation) spacecraft this year, considered capable to perform missions in the Moon.

Costs of the mission of reusable manned Ryvok spacecraft are by one third lower than the costs of the Federatsia spacecraft's mission.

According to the project, Ryvok should be stationed at the International Space Station (ISS). It would run between the ISS and the international lunar orbital platform to deliver cargos and cosmonauts who would arrive to the ISS with Soyuz spacecraft.

Earlier, Energia and NASA were in talks to build a space station that could orbit the Moon by the end of the next decade. ##

Past TTSIQ issues are online at: [www.moonsociety.org/international/ttsiq/](http://www.moonsociety.org/international/ttsiq/) and at: [www.nss.org/tothestars/](http://www.nss.org/tothestars/)

## Airbus Defence and Space to guide lunar lander to the Moon

[http://www.space-travel.com/reports/Airbus Defence and Space to guide lunar lander to the Moon 999.html](http://www.space-travel.com/reports/Airbus%20Defence%20and%20Space%20to%20guide%20lunar%20lander%20to%20the%20Moon%20999.html)

3 June, 2016 – Airbus Defence and Space and the European Space Agency (ESA), have signed a contract for the early development of a system that will ensure the safe and precise landing of the Russian Luna-Resource lunar lander.

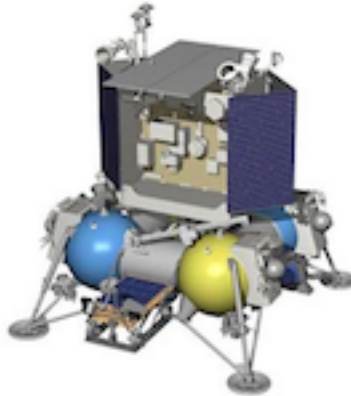

## To the Far Side of the Moon: China's Lunar Science Goals

9 June, 2016 – [www.space.com/32964-china-moon-far-side-mission-science-goals.html](http://www.space.com/32964-china-moon-far-side-mission-science-goals.html)

China is planning to land a probe on the far side of the moon as part of its Chang'e 4 lunar mission, with and new details about potential instruments for the spacecraft coming to light. The CE-4 scientific objectives are anchored to a lander, a rover, and use of a telecommunication relay that will be sent to the Earth-moon L2 Lagrange point.

Under the current plan, CE-4 would launch toward the moon in about 2018. The weight of payloads onboard the lander total about 77 pounds (35 kilograms) and 37 pounds (17 kilograms) on the rover.

## Moon Mining: It's closer than ever thanks to small Canadian company

[www.canadianminingjournal.com/features/moon-mining-its-closer-than-ever-thanks-to-a-small-canadian-company/](http://www.canadianminingjournal.com/features/moon-mining-its-closer-than-ever-thanks-to-a-small-canadian-company/)



Heavily studded wheels are a key design feature.

1 June, 2016 – Mining here on Earth is a brute force industry. If a rock is too big, hit it with a bigger hammer, But you can't take the same approach with space mining. You have to learn how to do things with very little weight and very little power.

Mining in outer space may seem like the stuff of science fiction but, in fact, it is going to happen sooner than most of us can imagine. NASA is currently planning a lunar Resource Prospector Mission; with a "notionally targeted launch" in 2018. Read on .... ##

## Surprise! Newfound Asteroid Is 'Quasi-Moon' of Earth

16 June 2016 – [www.space.com/33185-earth-quasi-moon-asteroid-2016-ho3.html](http://www.space.com/33185-earth-quasi-moon-asteroid-2016-ho3.html)  
<http://www.jpl.nasa.gov/news/news.php?feature=6537>  
[https://en.wikipedia.org/wiki/\(469219\)\\_2016\\_HO3](https://en.wikipedia.org/wiki/(469219)_2016_HO3)

It seems the Moon is not Earth's only cosmic companion – a small temporarily captive asteroid some 40–100 meters in size (130–330 ft.) is also “looping the Earth.” The newly discovered asteroid 2016 HO3 orbits the sun in such a way that the space rock never strays too far from Earth, making it a “quasi satellite” of Earth.

Calculations indicate 2016 HO3 has been a stable quasi-satellite of Earth **for almost a century**, and it will continue to follow this pattern as Earth's companion **for centuries to come.** Indeed, 2016 HO3 is the best example of an Earth quasi-satellite ever found.



White line is path of Earth around the Sun.

Yellow line is path of newly discovered asteroid 2016 HO3.

Wide yellow loop is apparent path of repeated “orbits” of newly discovered body around Earth.

## Russian Moon Base to Hold Up to 12 People

[www.space-travel.com/reports/Russian\\_Moon\\_Base\\_to\\_Hold\\_Up\\_to\\_12\\_People\\_999.html](http://www.space-travel.com/reports/Russian_Moon_Base_to_Hold_Up_to_12_People_999.html)

23 June, 2016 – Russian engineers are working on a project of a Moon base that will eventually hold up to 12 people, The lunar outpost project was initiated in the late 1960s–early 1970s. The base will be set up on the Moon surface, while radiation protection shelters and energy units can be hidden underground.

At the initial stage, the Moon base will be manned by no more than 2–4 people, with their number later rising to 10–12 people. ##



## New Book Notice: CASE FOR MOON by Robert Walker

Humanity's Gateway to the Solar System  
Open Ended Exploration with Planetary Protection at its Heart

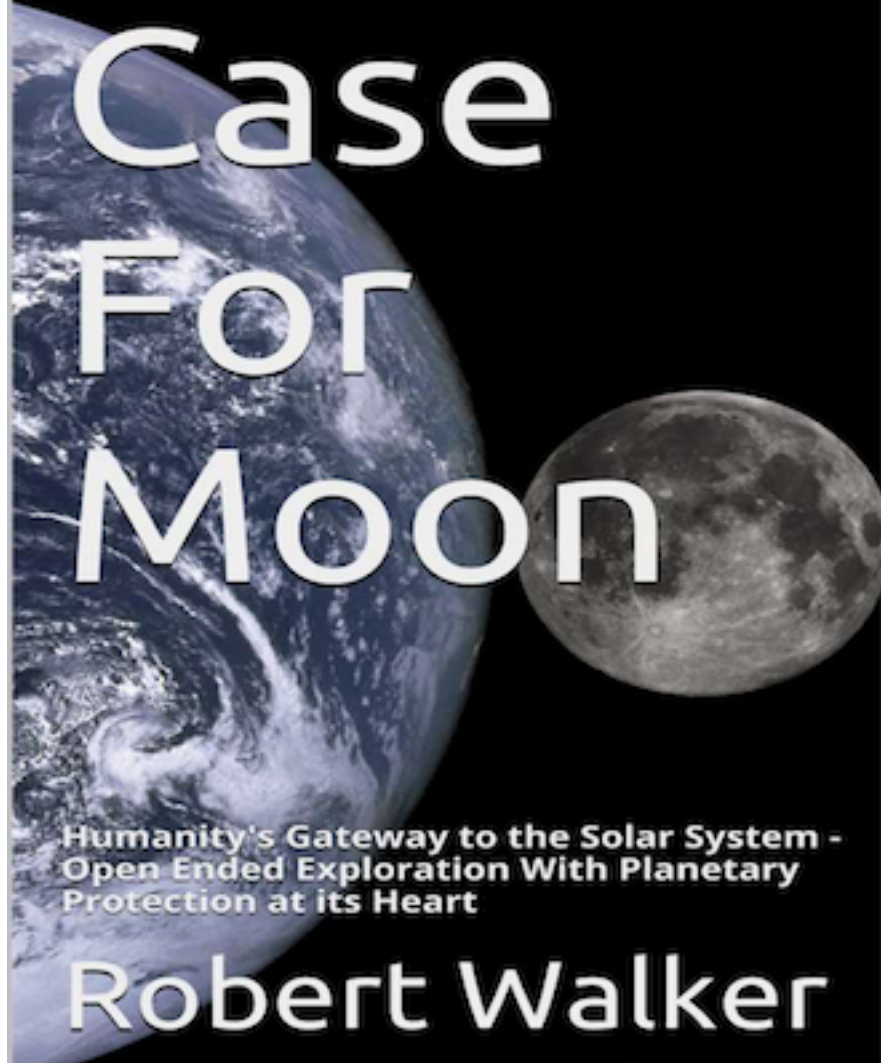

Full Review: <http://robertinventor.com/booklets/Online-Case-for-Moon.htm>

### Chapters

The Moon is Resource Rich

Executive summary

Who this is for

Search for inspiration

Positive vision for humans in space

The Moon is resource rich

Where to build our first lunar base for humans

The Moon is turning out to be much more interesting than expected

Buzz Aldrin's "been there done that" - not meant to be taken seriously

Moon firsters - ESA, Russia, Many astronauts, former US Vision for Space Exploration etc

Alternative positive vision for exploration of our solar system - main points

Moon as our gateway

This approach doesn't mean that humans can never land on Mars ever

Searching for a non confrontational way ahead

When will we know enough about Mars?

Precautionary principle and super positive outcomes

**Summary of the Vision ##**

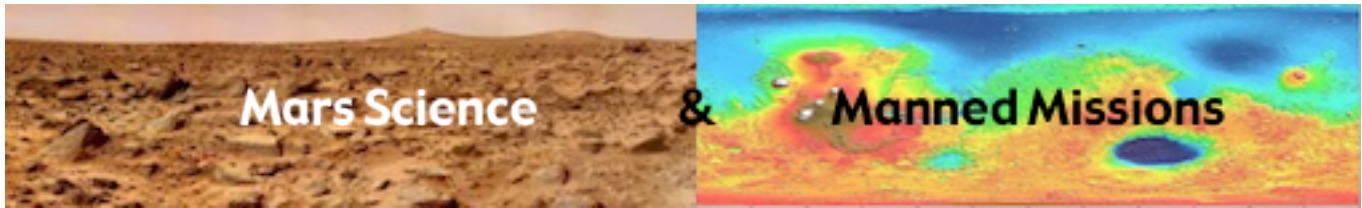

## MARS ANALOG EXERCISES

### 'Mixed Reality' Technology Brings Mars to Earth

1 April, 2016 [www.marsdaily.com/reports/Mixed\\_Reality\\_Technology\\_Bring\\_Mars\\_to\\_Earth\\_999.html](http://www.marsdaily.com/reports/Mixed_Reality_Technology_Bring_Mars_to_Earth_999.html)



NASA and Microsoft have teamed up to offer the public a guided tour of an area of Mars with astronaut Buzz Aldrin this summer in "Destination: Mars," an interactive exhibit using the Microsoft HoloLens mixed reality headset. "Mixed reality" means that virtual elements are merged with the user's actual environment, creating a world in which real and virtual objects can interact. ##

## TECHNOLOGIES & ROBOTICS

### NASA invests in 2D spacecraft, reprogrammable microorganisms

[www.spacedaily.com/reports/NASA\\_Invests\\_in\\_Two\\_Dimensional\\_Spacecraft\\_Reprogrammable\\_Microorganisms\\_999.html](http://www.spacedaily.com/reports/NASA_Invests_in_Two_Dimensional_Spacecraft_Reprogrammable_Microorganisms_999.html)

12 April, 2016 – Among 13 proposals through NASA Innovative Advanced Concepts (NIAC), a program that invests in transformative architectures through the development of pioneering technologies, is one that applies to Mars: a concept for **reprogramming microorganisms that could use the Martian environment to recycle and print electronics.** ##

### ESA's Mars Express Webcam goes pro

30 May, 2016 – [http://www.marsdaily.com/reports/Mars\\_Webcam\\_goes\\_pro\\_999.html](http://www.marsdaily.com/reports/Mars_Webcam_goes_pro_999.html)

Mars Express was launched in 2003 with a simple, low-resolution camera to provide visual confirmation that its Beagle 2 lander had separated. Once that was done, the camera was switched off, and the craft got on with its main mission using its 'real' scientific instruments

[www.esa.int/spaceinvideos/Videos/2016/05/Looking\\_at\\_the\\_limb\\_\(of\\_Mars\)](http://www.esa.int/spaceinvideos/Videos/2016/05/Looking_at_the_limb_(of_Mars))

Now ESA have decided to adopt it as a professional science instrument. The camera's unique vantage point means it can capture crescent images of Mars impossible from Earth. Its wide field of view provides global images of the Red Planet, a capability available on only one other Mars craft, India's orbiter. ##



## MARS SCIENCE &amp; MISSIONS

## Mile-high Mars mounds built by wind and climate change

31 March, 2016 - <http://phys.org/news/2016-03-mile-high-mars-mounds-built-climate.html>

New research shows wind-carved massive mounds more than a mile high on Mars over billions of years. Their location helps pin down when water on Mars dried up during a global climate change event.

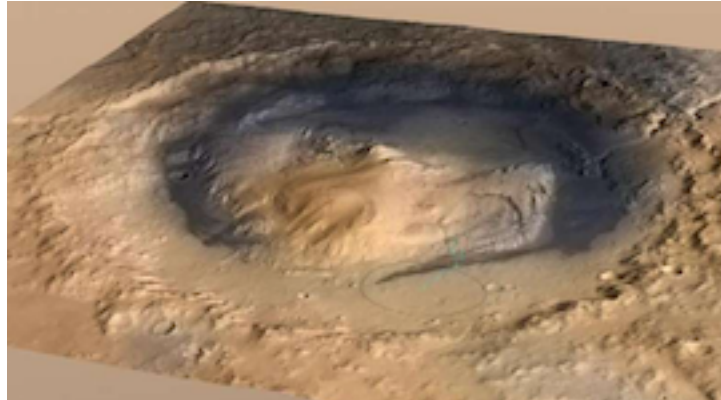

Gale Crater, the landing spot of the Mars rover Curiosity, has a three-mile-high mound at its center called Mount Sharp. The circle is the landing place of Curiosity. The blue line is its path. ##

## Mars Life Hunt: Could Basin Host Remains of an Ancient Biosphere?

1 April, 2016 - [www.space.com/32440-mars-life-search-argyre-basin.html](http://www.space.com/32440-mars-life-search-argyre-basin.html)

[https://en.wikipedia.org/wiki/Argyre\\_Planitia](https://en.wikipedia.org/wiki/Argyre_Planitia)

An enormous basin in the southern hemisphere of Mars might be the best place to search for signs of past and present Red Planet life, a new study suggests. [Note: the Hellas basin, also in the Southern Hemisphere is more vast and considerably deeper with higher air pressure.]

The Argyre basin contains a wealth of ingredients thought necessary for the evolution of life, and should be a prime target for a series of future Mars missions.

The lowest of the northern plains are among the flattest, smoothest places in the solar system, potentially created by water that once flowed across the Martian surface.

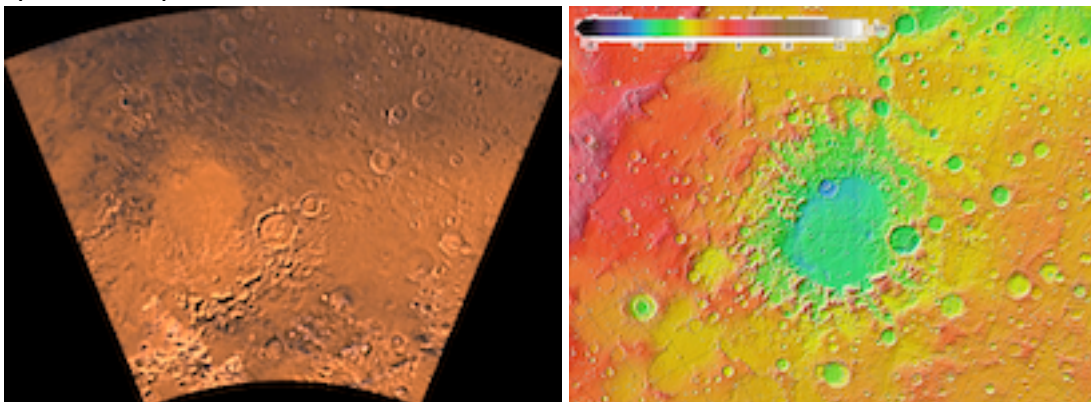

##

## How gypsum forms might tell us more about water on Mars

1 April, 2016 - <http://phys.org/news/2016-04-scientists-gypsum-formsand-mars.html>

A new explanation of how gypsum forms may change the way we process this important building material, as well as allow us to interpret past water availability on other planets such as Mars.

Gypsum ( $\text{CaSO}_4 \cdot 2\text{H}_2\text{O}$ ) is an economically important mineral, extensively used as the commercial construction material Plaster of Paris, with a global production of ~100 billion kg per year. It is a

ubiquitous mineral on the Earth's surface, and is also found on the surface of Mars. Despite its importance, until now we have not understood how gypsum grows from ions in solutions.

European geochemists have now shown that gypsum forms through a complex 4-step process: "We know that gypsum is naturally found on Mars, so applying our current finding will also help us understand and predict hydrological conditions at the time of gypsum formation on other planets" ##

## Ancient Mars bombardment enhanced life-supporting habitat

<http://phys.org/news/2016-04-ancient-mars-bombardment-life-supporting-habitat.html>

5 April, 2016 – The bombardment of Mars some 4 billion years ago by comets and asteroids as large as West Virginia likely enhanced climate conditions enough to make the planet more conducive to life, at least for a time

## Mysterious Mars Mounds Were Liquid-Filled Craters

5 April, 2016 – [www.space.com/32466-mysterious-mars-mounds-were-liquid-filled-craters.html](http://www.space.com/32466-mysterious-mars-mounds-were-liquid-filled-craters.html)

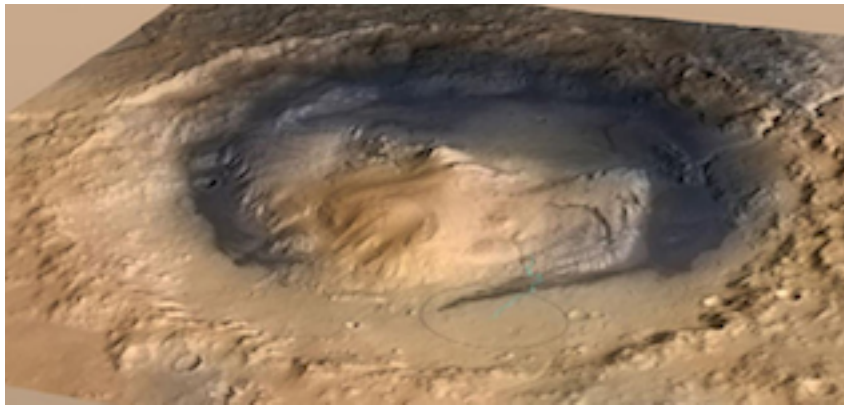

Gale Crater which the Curiosity rover is exploring

On Mars, formerly water-filled craters transformed to dry mile-high mounds with the help of wind, according to new research.

The results explain the geography of Gale Crater (the Curiosity rover's landing site) as well as other high-topped places on Mars, and confirm that wind is currently the dominant force in Mars' geology. (Mars has no widespread plate tectonics or liquid water today). ##

## Opportunity rover spots Dust Devil from high perch

8 April, 2016 – [www.marsdaily.com/reports/Opportunitys\\_Devilish\\_View\\_from\\_on\\_High\\_999.html](http://www.marsdaily.com/reports/Opportunitys_Devilish_View_from_on_High_999.html)



From its perch high on a ridge, NASA's Mars Exploration Rover Opportunity recorded this image of a Martian dust devil twisting through the valley below

Just as on Earth, a dust devil is created by a rising, rotating column of hot air. When the column whirls fast enough, it picks up tiny grains of dust from the ground, making the vortex visible.

The view looks back at the rover's tracks leading up the north-facing slope of "Knudsen Ridge," which forms part of the southern edge of "Marathon Valley."

Dust devils were a common sight for Opportunity's twin rover, Spirit, in its outpost at Gusev Crater. Dust devils have been an uncommon sight for Opportunity, though. ##

### Joint EU-Russian ExoMars mission to reach Mars orbit Oct 16

[www.marsdaily.com/reports/First\\_joint\\_EU-Russian\\_ExoMars\\_mission\\_to\\_reach\\_Mars\\_orbit\\_Oct\\_16\\_999.html](http://www.marsdaily.com/reports/First_joint_EU-Russian_ExoMars_mission_to_reach_Mars_orbit_Oct_16_999.html)

13 April, 2016 – A Russian Proton-M rocket carrier lifted off with the ExoMars' orbital and the landing modules from the Baikonur Cosmodrome in Kazakhstan on March 14.

The ExoMars-2016's main mission is **to prove the existence of methane in the planet's atmosphere, which would confirm the existence of life on Mars.** ##

### Joint EU-Russian ExoMars mission Russia, Italy plan first bid to explore beneath Mars surface in 2018

[www.marsdaily.com/reports/Russia\\_Italy\\_plan\\_first\\_bid\\_to\\_explore\\_beneath\\_mars\\_surface\\_in\\_2018\\_999.html](http://www.marsdaily.com/reports/Russia_Italy_plan_first_bid_to_explore_beneath_mars_surface_in_2018_999.html)

15 April, 2016 – The Russian and Italian space agencies have joined forces on the first mission to drill deep beneath the surface of Mars in 2018 and explore the geological composition of the planet's crust.

### Rover mini-walkabout to find Clay Mineral continues

[www.marsdaily.com/reports/Rover\\_mini\\_walkabout\\_to\\_find\\_clay\\_mineral\\_continues\\_999.html](http://www.marsdaily.com/reports/Rover_mini_walkabout_to_find_clay_mineral_continues_999.html)



19 April, 2016 – Opportunity is exploring the south side of 'Marathon Valley' located on the rim of Endeavour crater. Opportunity is conducting a mini-'walkabout' in regions that show evidence for clay minerals seen from orbit, to identify specific outcrops. ##

### NASA Seeks Industry Ideas for an Advanced Mars Satellite

[www.nasa.gov/press-release/nasa-seeks-industry-ideas-for-an-advanced-mars-satellite](http://www.nasa.gov/press-release/nasa-seeks-industry-ideas-for-an-advanced-mars-satellite)

21 April, 2016 – NASA is soliciting ideas from U.S. industry for designs of a Mars orbiter for potential launch in the 2020s. The satellite would provide

- ✓ advanced communications and imaging,
- ✓ as well as robotic science exploration
- ✓ substantially increased bandwidth communications
- ✓ high-resolution imaging capability
- ✓ experimental cutting-edge technologies, such as high-power solar electric propulsion or an optical communications package, which could greatly improve transmission speed and capacity over radio frequency systems.

To view the Mars orbiter solicitation/Federal Business Opportunities announcement, visit:

<http://1.usa.gov/22RtMEC>

## China targets 2020 Mars mission launch

[www.spacedaily.com/reports/China\\_targets\\_2020\\_Mars\\_mission\\_launch\\_official\\_999.html](http://www.spacedaily.com/reports/China_targets_2020_Mars_mission_launch_official_999.html)  
[www.space.com/32715-china-mars-moon-exploration-plans.html](http://www.space.com/32715-china-mars-moon-exploration-plans.html)

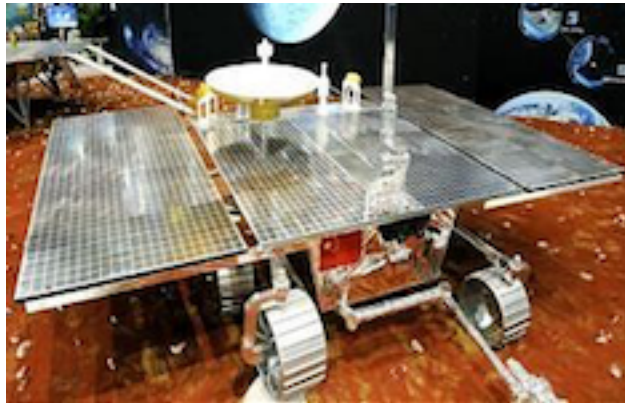

22 April, 2016 – "What we want to achieve is to orbit Mars, land, and deploy the rover in one mission, which will be quite difficult to achieve." Once on the Martian surface, the Chinese rover could study the planet's soil, atmosphere, environment, and look for traces of water. ##

## NASA rocket fuel pump tests pave way for methane-fueled Mars lander

[www.spacedaily.com/reports/NASA\\_rocket\\_fuel\\_pump\\_tests\\_pave\\_way\\_for\\_methane\\_fueled\\_Mars\\_lander\\_999.html](http://www.spacedaily.com/reports/NASA_rocket_fuel_pump_tests_pave_way_for_methane_fueled_Mars_lander_999.html)

22 April, 2016 – NASA has tested a **3-D printed rocket engine turbopump** with liquid methane – an ideal propellant for engines needed to power many types of spacecraft for NASA's journey to Mars.

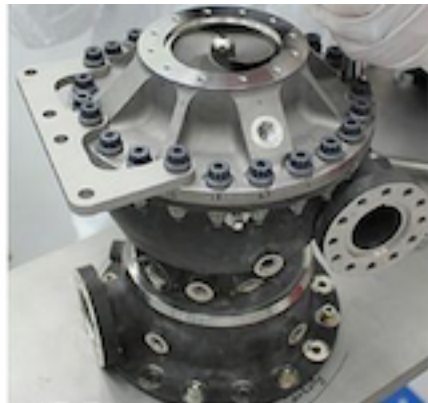

This rocket engine fuel pump has hundreds of parts including a turbine that spins at over 90,000 rpms. This turbopump was made with additive manufacturing and had 45 percent fewer parts than pumps made with traditional manufacturing. It completed testing under flight-like conditions at NASA's Marshall Space Center. ##

## Eavesdropping on Mars: NASA Rover to Record Red Planet's Wind and More

26 April, 2016 – [www.space.com/32696-microphone-on-nasa-mars-rover-2020.html](http://www.space.com/32696-microphone-on-nasa-mars-rover-2020.html)  
[www.space.com/21900-nasa-mars-rover-2020-images.html](http://www.space.com/21900-nasa-mars-rover-2020-images.html)

When NASA sends its **Mars 2020 rover** to the Red Planet, the bot may include an instrument to detect sound waves. The main scientific purpose of the instrument would be to study the composition of Martian rocks, but scientists with the mission said listening to the sounds of Mars could garner great interest from the public.

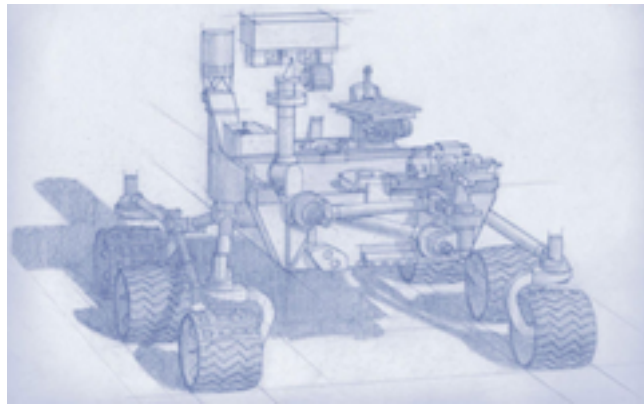

Current

design ##

## Curiosity Rover on Mars Is Climbing Mountain Despite Wheel Damage

3 May, 2016 = [www.space.com/32774-mars-rover-curiosity-mountain-climb-wheel-damage.html](http://www.space.com/32774-mars-rover-curiosity-mountain-climb-wheel-damage.html)



The team operating NASA's Curiosity Mars rover uses the MAHLI camera on the rover's arm to check the condition of the wheels.

Mars' rugged terrain is taking its toll on the 6 wheels of the Curiosity rover, but the robot should be able to complete its mountain-climbing science mission regardless. ##

## 2nd ExoMars mission moves to next launch opportunity to 2020

[http://m.esa.int/Our\\_Activities/Space\\_Science/ExoMars/Second\\_ExoMars\\_mission\\_moves\\_to\\_next\\_launch\\_opportunity\\_in\\_2020](http://m.esa.int/Our_Activities/Space_Science/ExoMars/Second_ExoMars_mission_moves_to_next_launch_opportunity_in_2020)

[www.marsdaily.com/reports/Second\\_ExoMars\\_mission\\_moves\\_to\\_next\\_launch\\_opportunity\\_in\\_2020\\_999.html](http://www.marsdaily.com/reports/Second_ExoMars_mission_moves_to_next_launch_opportunity_in_2020_999.html)

<http://www.space.com/32771-europes-mars-life-detection-mission-postponed.html>

<http://phys.org/news/2016-05-phase-exomars-mission.html>

2 May, 2016 - The 1<sup>st</sup> ExoMars 2016 spacecraft are due to arrive at Mars in October 2016. The 2<sup>nd</sup> ExoMars mission involves a Russian-led surface platform and a European-led rover, also to be launched on a Proton from Baikonur.

The Joint ExoMars Steering Board (JESB) held in Moscow, having assessed the possible ways to ensure successful mission implementation, the JESB concluded that, taking into account the delays in European and Russian industrial activities and deliveries of the scientific payload, a launch in 2020, instead of 2018, would be the best solution. ##

## Boiling water may be cause of Martian streaks

[www.marsdaily.com/reports/Boiling\\_water\\_may\\_be\\_cause\\_of\\_Martian\\_streaks\\_study\\_999.html](http://www.marsdaily.com/reports/Boiling_water_may_be_cause_of_Martian_streaks_study_999.html)

<http://phys.org/news/2016-05-martian-streaks.html>

2 May, 2016 – A team from France, Britain and the United States constructed models and simulated Mars conditions to follow up on a 2015 study which proffered "the strongest evidence yet" for liquid water -- a prerequisite for life -- on the Red Planet.

The low pressure of Mars' atmosphere means that water does not survive long in liquid form. It either boils or freezes. Identifying water on Mars is complicated by our limited understanding of natural processes under conditions so different to those on Earth.

The curious lines running down slopes on the Martian surface in "summer" may be streaks of super-salty brine. There was evidence in the lines of "hydrated" salt minerals that requires water for their creation. Up to a few hundred metres in length and typically under five metres (16 feet) wide, these lines appear on slopes during warm seasons, lengthen, then fade as they cool.

Under Martian pressure, melting ice produced a liquid which boiled vigorously as it flowed downslope and filtered into the sand. The evaporating water vapour blasted grains upward, creating ridges which collapse onto themselves when they become too steep, forming channels.

"This process in which unstable boiling water causes grains to hop and trigger slope failures may underlie some of the active landforms observed on the Martian surface." ##

## Found: Clues about volcanoes under ice on ancient Mars

3 May, 2016 – <http://phys.org/news/2016-05-clues-volcanoes-ice-ancient-mars.html>

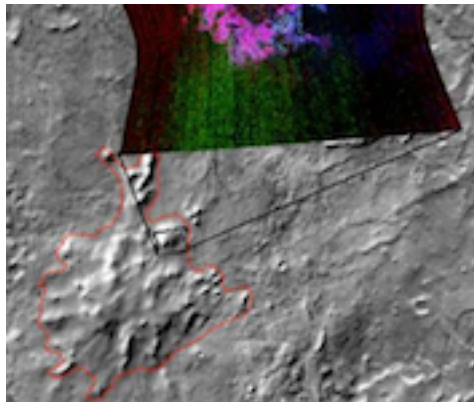

This graphic illustrates where Mars mineral-mapping from orbit has detected a few minerals -- **sulfates** (blue) and **iron oxides** (pink) -- that can indicate where a volcano erupted beneath an ice sheet.

The site is far from any ice sheet on modern Mars, in oddly textured terrain where the shapes of flat-topped mountains had previously been recognized as a possible result of ancient subglacial volcanism. These mountains are in a region called Sisyphi Montes.

These findings strengthen the evidence for volcanic eruptions that burst through a cover of ice.

In this graphic, the base image shows a portion of the region about 230 km (130 mi) across, centered at 17.73 °E longitude, 63.46 °S latitude. Red outlines indicate possible subglacial volcanic structures. ##

## The rise and fall of Martian lakes

12 May, 2016 – <http://phys.org/news/2016-05-fall-martian-lakes.html>

The images below, put together from images produced by the Mars Orbiter Laser Altimeter (MOLA) on NASA's Mars Global Surveyor (MGS), shows the region of Mars known as the Terra Sirenum and Terra Cimmeria regions. This region, peppered with basins that once held one of Mars' largest lakes, was the subject of a study published in the Journal of Geophysical Research which aimed to better understand past environmental conditions in the region.

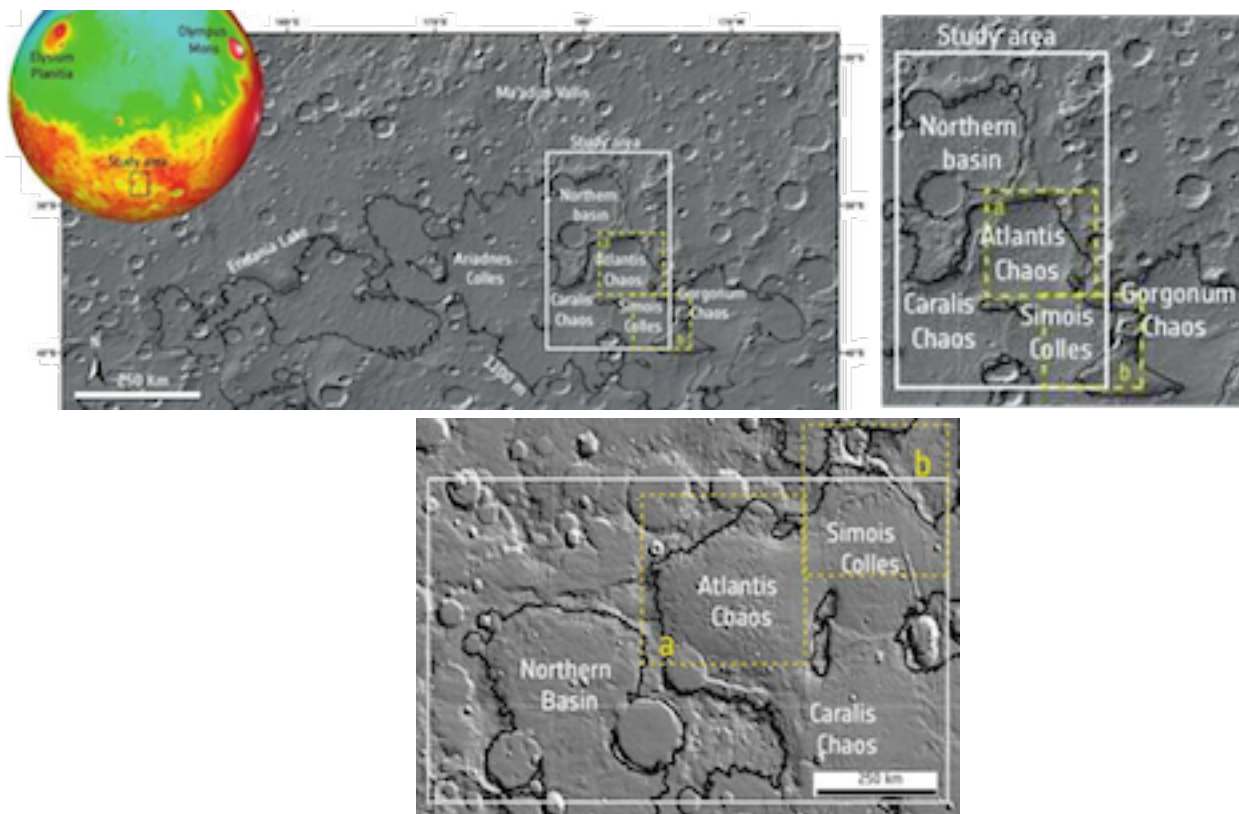

The image above shows two of the regions – Atlantis Chaos and Simois Colles – that were the the subject of a study published in the Journal of Geophysical Research which aimed to better understand past environmental conditions in the Terra Sirenum and Terra Cimmeria regions on Mars. The image is produced with data from the Mars Orbiter Laser Altimeter (MOLA) on NASA's Mars Global Surveyor. ##

## Mysterious Mars Methane Spike Not a Seasonal Event

16 May, 2016 – [www.space.com/32871-mars-methane-spike-curiosity-rover-mystery.html](http://www.space.com/32871-mars-methane-spike-curiosity-rover-mystery.html)

For a few weeks in late 2013 and early 2014, Curiosity notice that atmospheric methane — a gas that could possibly be an indication of microbial activity — surged from an average background level of about 0.7 parts per billion all the way up to 7 parts per billion.

That increase occurred during the rover's first Martian autumn. But the methane spike did not recur in the second Red Planet autumn, ##

## Mega tsunamis rocked Mars oceans billions of years ago

21 May, 2016 [www.accuweather.com/en/features/trend/mega\\_tsunamis\\_rocked\\_mars\\_ocea/57560070](http://www.accuweather.com/en/features/trend/mega_tsunamis_rocked_mars_ocea/57560070)

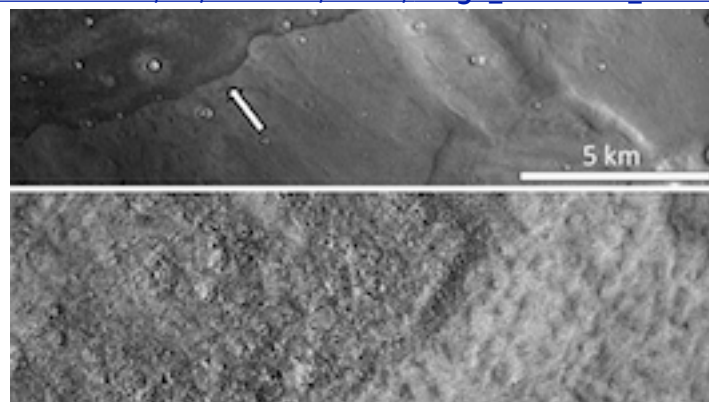

These visible-light views of Mars show lobe-like deposits probably caused by tsunamis (top image) and the bouldery material the huge wave deposited (bottom image). Traces of tsunamis on Mars are the newest clues yet that the Red Planet once had oceans, which could have supported life. These killer waves might have been triggered by giant meteor impacts, scientists added.

Although the surface of Mars is now cold and dry, there is a **great deal of evidence suggesting that an ocean's worth of water covered the Red Planet billions of years ago.** ##

## Are mystery Mars plumes caused by space weather?

[www.marsdaily.com/reports/Are\\_mystery\\_Mars\\_plumes\\_caused\\_by\\_space\\_weather\\_999.html](http://www.marsdaily.com/reports/Are_mystery_Mars_plumes_caused_by_space_weather_999.html)

24 May, 2016 – Mysterious high-rise clouds seen appearing suddenly in the martian atmosphere on a handful of occasions may be linked to space weather, say Mars Express scientists. Amateur astronomers using telescopes on Earth were the first to report an unusual cloud-like plume in 2012 that topped-out high above the surface of Mars at an altitude around 250 km. The feature developed in less than 10 hours, covered an area of up to 1000 x 500 km, and remained visible for around 10 days.

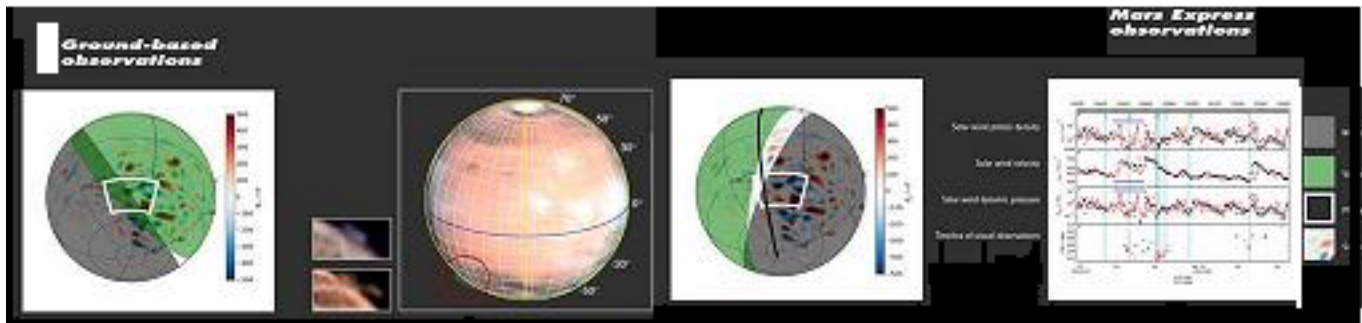

Examples of Earth-based observations of the mysterious plume seen on 21 March 2012 (left) and of Mars Express solar wind observations during March and April 2012 (right). The left-hand graphics depict the region visible from Earth at the time (green), the nightside of Mars (grey) and the surface crustal magnetism; ##

## Red Planet Heats Up: Ice Age Ending on Mars

26 May, 2016 = [www.space.com/33001-mars-ice-age-ending-now.html](http://www.space.com/33001-mars-ice-age-ending-now.html)

Mars is emerging from an ice age, shedding light on the past and future climates of both Mars and Earth,

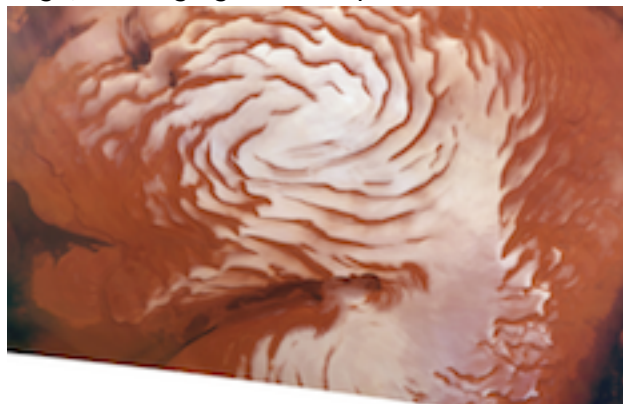

The north polar ice cap of Mars is seen in this mosaic view, which scientists made by combining data from the European Mars Express spacecraft and Mars Reconnaissance Orbiter. The spiral features help scientists understand how ice ages on Mars work.

The orbit of Mars regularly undergoes changes that greatly affect how much sunlight reaches the planet's surface, which in turn can strongly alter the Red Planet's climate. Similar orbital variations called Milankovitch cycles are known to happen on Earth. ##



## Boiling water may be cause of Martian streaks

[www.marsdaily.com/reports/Boiling\\_water\\_may\\_be\\_cause\\_of\\_Martian\\_streaks\\_study\\_999.html](http://www.marsdaily.com/reports/Boiling_water_may_be_cause_of_Martian_streaks_study_999.html)

<http://phys.org/news/2016-05-martian-streaks.html>

2 May, 2016 – A team from France, Britain and the United States constructed models and simulated Mars conditions to follow up on a 2015 study which proffered "the strongest evidence yet" for liquid water -- a prerequisite for life -- on the Red Planet.

The low pressure of Mars' atmosphere means that water does not survive long in liquid form. It either boils or freezes. Identifying water on Mars is complicated by our limited understanding of natural processes under conditions so different to those on Earth.

The curious lines running down slopes on the Martian surface in "summer" may be streaks of super-salty brine. There was evidence in the lines of "hydrated" salt minerals that requires water for their creation. Up to a few hundred metres in length and typically under five metres (16 feet) wide, these lines appear on slopes during warm seasons, lengthen, then fade as they cool.

Under Martian pressure, melting ice produced a liquid which boiled vigorously as it flowed downslope and filtered into the sand. The evaporating water vapour blasted grains upward, creating ridges which collapse onto themselves when they become too steep, forming channels.

"This process in which unstable boiling water causes grains to hop and trigger slope failures may underlie some of the active landforms observed on the Martian surface." ##

## Found: Clues about volcanoes under ice on ancient Mars

3 May, 2016 – <http://phys.org/news/2016-05-clues-volcanoes-ice-ancient-mars.html>

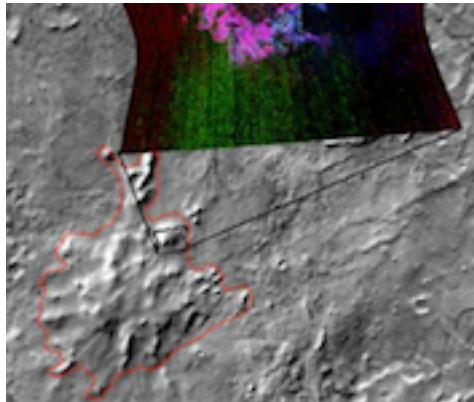

This graphic illustrates where Mars mineral-mapping from orbit has detected a few minerals -- **sulfates** (blue) and **iron oxides** (pink) -- that can indicate where a volcano erupted beneath an ice sheet.

The site is far from any ice sheet on modern Mars, in oddly textured terrain where the shapes of flat-topped mountains had previously been recognized as a possible result of ancient subglacial volcanism. These mountains are in a region called Sisyphi Montes.

These findings strengthen the evidence for volcanic eruptions that burst through a cover of ice.

In this graphic, the base image shows a portion of the region about 230 km (130 mi) across, centered at 17.73 °E longitude, 63.46 °S latitude. Red outlines indicate possible subglacial volcanic structures. ##

## Found: Clues about volcanoes under ice on ancient Mars

3 May, 2016 – <http://phys.org/news/2016-05-clues-volcanoes-ice-ancient-mars.html>

The site is far from any ice sheet on modern Mars, in oddly textured terrain where the shapes of flat-topped mountains had previously been recognized as a possible result of ancient subglacial volcanism. These mountains are in a region called Sisyphi Montes.

These findings strengthen the evidence for volcanic eruptions that burst through a cover of ice.

The site is far from any ice sheet on modern Mars, in oddly textured terrain where the shapes of flat-topped mountains had previously been recognized as a possible result of ancient subglacial volcanism. These mountains are in a region called Sisyphi Montes.

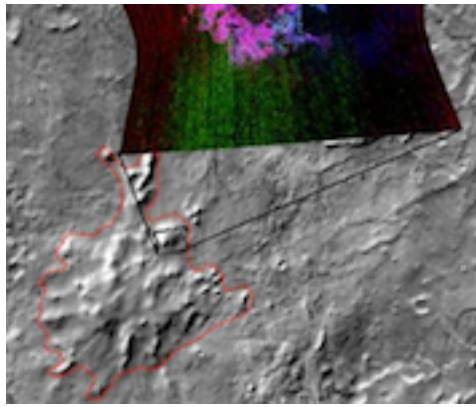

This graphic illustrates where Mars mineral-mapping from orbit has detected a few minerals -- **sulfates** (blue) and **iron oxides** (pink) -- that can indicate where a volcano erupted beneath an ice sheet.

These findings strengthen the evidence for volcanic eruptions that burst through a cover of ice.

In this graphic, the base image shows a portion of the region about 230 km (130 mi) across, centered at 17.73 °E longitude, 63.46 °S latitude. Red outlines indicate possible subglacial volcanic structures. ##

## NASA Mars Orbiters Reveal Seasonal Dust Storm Pattern

[www.marsdaily.com/reports/NASA\\_Mars\\_Orbiters\\_Reveal\\_Seasonal\\_Dust\\_Storm\\_Pattern\\_999.html](http://www.marsdaily.com/reports/NASA_Mars_Orbiters_Reveal_Seasonal_Dust_Storm_Pattern_999.html)

10 June, 2017 – After decades of research to discern seasonal patterns in Martian dust storms from images showing the dust, but the clearest pattern appears to be captured by measuring the temperature of the Red Planet's atmosphere.

For six recent Martian years, temperature records from NASA Mars orbiters reveal a pattern of three types of large regional dust storms occurring in sequence at about the same times each year during the southern hemisphere spring and summer. Each Martian year lasts about two Earth years. ##

## NASA Weighs Use of Rover to Image Potential Mars Water Sites

[www.marsdaily.com/reports/NASA\\_Weighs\\_Use\\_of\\_Rover\\_to\\_Image\\_Potential\\_Mars\\_Water\\_Sites\\_999.html](http://www.marsdaily.com/reports/NASA_Weighs_Use_of_Rover_to_Image_Potential_Mars_Water_Sites_999.html)

28 June, 2016 – Ever since it was announced that there may be evidence of liquid water on present-day Mars, NASA scientists have wondered how best to further investigate these long, seasonally changing dark streaks in the hope of finding evidence of life – past or present – on the Red Planet.

It's not as simple as driving a rover to a potential site and taking a scoop of soil. Not only are these on steep slopes, we need to ensure that planetary protection concerns are met. In other words, how can we search for evidence of life without contaminating the sites with bugs from Earth."

NASA's Curiosity Mars rover will continue to climb to progressively higher and younger strata on Mount Sharp, investigating how long the ancient, water-rich environments found so far persisted as Mars dried out.

Reaching those destinations would bring the rover closer to locations where dark streaks are present on some slopes. On the way, the route would allow the one-ton rover to capture images of the potential water sites from miles away and see if any are the seasonally changing type. ##

## Omani Wells May Shed Light on Martian Methane

[www.space.com/33230-martian-methane-illuminated-by-earth-wells.html?cmpid=NL\\_SP\\_weekly\\_2016-6-22](http://www.space.com/33230-martian-methane-illuminated-by-earth-wells.html?cmpid=NL_SP_weekly_2016-6-22) – 21 June, 2016 – Methane gas on Mars may represent signs of past or present extraterrestrial life — or it could simply come from non-living geological processes. Scientists aim to solve that Martian mystery by studying methane-producing organisms living within remote wells in the Middle Eastern country of Oman.

Methane gas on Mars may be signs of past or present extraterrestrial life — or it could simply come from non-living geological processes. Scientists aim to solve that Martian mystery by studying methane-producing organisms living within remote wells in the Middle Eastern country of Oman.

The Omani wells go down hundreds of meters beneath the Earth's surface to reach rock layers that store underground water. Such environments, where rocks from our planet's mantle are in contact with water, could provide clues about the possible past or present habitability of planets such as Mars.

## Mars' Atmosphere Was Likely More Oxygen-Rich Long Ago

29 June, 2016 - [www.space.com/33296-mars-atmosphere-oxygen-curiosity-rover.html](http://www.space.com/33296-mars-atmosphere-oxygen-curiosity-rover.html)



This photo shows NASA's Mars rover Curiosity at a location called "Windjana," where the rover found rocks containing manganese-oxide minerals, which require abundant water and strongly oxidizing conditions to form. This suggests that the Martian atmosphere contained more oxygen billions of years ago than it does today/ ##

## HUMANS TO MARS

### How Buzz Aldrin Took a Virtual Walk on Mars

13 April, 2016 - [www.space.com/32563-how-buzz-aldrin-took-a-virtual-walk-on-mars.html](http://www.space.com/32563-how-buzz-aldrin-took-a-virtual-walk-on-mars.html)



Apollo 11 moonwalker Buzz Aldrin made a special appearance "on Mars" as part of a new exhibit at the Kennedy Space Center in Florida.

#### The First Humans on Mars will be Virtual Explorers

Aldrin is a part of a new exhibit at NASA's Kennedy Space Center called, appropriately enough, "Destination: Mars." As a holograph, NASA felt he would help bring the barren landscape alive as he described his red-tinged surroundings. And it's finally a chance for the public to get a glimpse of the new virtual reality software the agency is using to explore the Red Planet. ##

## NASA Seeks Proposals for Deep Space Habitation Prototypes

20 April, 2016 – [www.nasa.gov/press-release/nasa-seeks-proposals-for-deep-space-habitation-prototypes](http://www.nasa.gov/press-release/nasa-seeks-proposals-for-deep-space-habitation-prototypes)

NASA is soliciting proposals for development of prototypes for deep space habitats that will give astronauts a place to call home during long-duration missions supporting the agency's Journey to Mars.

**NextSTEP** is a public-private partnership model that seeks commercial development of deep space exploration capabilities to support more extensive human spaceflight missions in the proving ground of space **around the Moon** (cislunar space), and to enable **transit to Mars** and innovative concepts that support private industry commercialization plans for **low-Earth orbit**.

Proposals will include plans for an evolvable approach to long-duration deep space habitation and the development of **full-size, ground prototype habitat units no later than 2018**. ##

## NASA Eyeing New Mars Orbiter Mission

27 April, 2016 – [www.space.com/32706-nasa-new-mars-orbiter-2020s.html](http://www.space.com/32706-nasa-new-mars-orbiter-2020s.html)

NASA is asking American companies to suggest design ideas for the possible robotic Mars orbiter. Launching in the 2020s, it would capture **high-resolution imagery** and provide **increased data-relay capabilities from surface vehicles** back to mission control on Earth.

**High-bandwidth** communication with Earth and **overhead imaging** will be required. This new orbiter will use cutting-edge technology to revitalize our ability to continue to explore Mars and support transformative science, including a potential sample-return mission in the future. ##

## SpaceX Will Launch Private Mars Missions as Soon as 2018

27 April, 2016 – [www.space.com/32719-spacex-red-dragon-mars-missions-2018.html](http://www.space.com/32719-spacex-red-dragon-mars-missions-2018.html)

[https://en.wikipedia.org/wiki/Red\\_Dragon\\_\(spacecraft\)](https://en.wikipedia.org/wiki/Red_Dragon_(spacecraft))

[www.space.com/32720-spacex-plans-mars-missions-as-soon-as-2018-video.html](http://www.space.com/32720-spacex-plans-mars-missions-as-soon-as-2018-video.html)

[www.space.com/30504-spacex-red-dragon-mars-sample-return.html](http://www.space.com/30504-spacex-red-dragon-mars-sample-return.html)

[www.space.com/32721-private-mars-missions-spacex-red-dragon.html](http://www.space.com/32721-private-mars-missions-spacex-red-dragon.html)



Space-X "Red Dragon" crew capsule would be the first such capsule on Mars.

The commercial spaceflight company SpaceX plans to send its robotic Dragon capsule to Mars as early as 2018. "Red Dragons will inform the overall Mars architecture," referring to the company's eventual plans to set up an outpost on Mars — a key goal of SpaceX and its founder, billionaire entrepreneur Elon Musk.

The first test flight of a Dragon capsule to Mars would demonstrate technologies needed to land large payloads on the planet. That could include supplies and habitats for Martian explorers. In addition, the source said that SpaceX intends to reveal details of its colonization architecture later this year. ##

## Mars Comes to Earth: Scientists 'Visit' Red Planet with Augmented Reality

27 April, 2016 – [www.space.com/32716-nasa-augmented-reality-tech-mars-exploration.html](http://www.space.com/32716-nasa-augmented-reality-tech-mars-exploration.html)



A screen view from OnSight, a software tool developed by NASA's Jet Propulsion Laboratory in collaboration with Microsoft. OnSight uses real rover data to create a 3D simulation of the Martian environment.

The OnSight software uses real data collected by NASA's Curiosity rover on Mars to create a 3D holographic simulation of the Martian landscape. Scientists wearing the HoloLens headsets can virtually walk around on the Red Planet and interact with the environment. ##

## Select proposals to support astronaut health on long missions

[www.spacedaily.com/reports/NASA\\_NSBRI\\_Select\\_Proposals\\_to\\_Support\\_Astronaut\\_Health\\_on\\_Long\\_Duration\\_Space\\_Exploration\\_Missions\\_999.html](http://www.spacedaily.com/reports/NASA_NSBRI_Select_Proposals_to_Support_Astronaut_Health_on_Long_Duration_Space_Exploration_Missions_999.html)

6 May, 2016 – NASA's Human Research Program and the National Space Biomedical Research Institute (NSBRI) will **fund 27 proposals to help answer questions about astronaut health and performance during future long duration missions beyond low Earth orbit.**

The selected proposals will investigate the **impact of the space environment on various aspects of astronaut health**, including visual impairment, behavioral health and performance, bone and muscle loss, cardiovascular alterations, human factors and performance, sensorimotor adaptation and the development and application of smart medical systems and technologies. ##

## Out of this world: 'Moon and Mars veggies' grow in Dutch greenhouse

17 May, 2016 – <http://phys.org/news/2016-05-world-moon-mars-veggies-dutch.html>



Researcher inspects the plants grown in Mars and moon soil simulant in a research facility at the University of Wageningen

How can humans survive for months or years in the ultra-hostile environment of space? What, for instance, will they eat? Agricultural researchers at a Dutch university say they are taking the first steps towards providing an answer. They are growing vegetables in soils similar to those found on the Moon and Mars, looking for ways of helping space pioneers grow their own crops.

Past TTSIQ issues are online at: [www.moonsociety.org/international/ttsiq/](http://www.moonsociety.org/international/ttsiq/) and at: [www.nss.org/tothestars/](http://www.nss.org/tothestars/)

Of course, getting real lunar and Martian potting soil is an impossible ask. But an Internet search revealed an unlikely supplier: NASA, which makes ground similar to that on the Moon from sand found in an Arizona desert, while Mars' crimson "soil" is scooped from a volcano in Hawaii. They stuck tomatoes, peas, cress and other plants in pots containing the simulated soil... and crossed his fingers. Read on. ##

## Humans on Mars: Scouting Needed for Red Planet Resources

16 May, 2016 - [www.space.com/32882-nasa-crewed-mars-missions-resources-orbiter.html](http://www.space.com/32882-nasa-crewed-mars-missions-resources-orbiter.html)

NASA's quest to put boots on Mars in the 2030s is advancing, bolstered by new studies about a multifunction, next-generation Mars orbiter and the best ways to use Red Planet resources to sustain astronaut pioneers.

Last year, scientists proposed **nearly 50 locations** on Mars as possible places for future human landings that contain "regions of interest" **that can be reached from primary touchdown spots**.

Good touchdown sites will allow crews to land safely and carry out operations; offer a wealth of interesting science activities; and provide resources that the astronauts could use.

For example, any favored exploration zone should allow expeditionary crews to tap into at least 100 metric tons (110 U.S. tons) of water. ##

## Ancient Solar Superflare Suggests Risks for Manned Mars Missions

23 May 2106 - [www.space.com/32942-solar-superflare-risks-for-mars-missions.html](http://www.space.com/32942-solar-superflare-risks-for-mars-missions.html)

When a powerful "superflare" from the sun scoured the solar system more than 1,200 years ago, it apparently had little effect on Earth's inhabitants — but astronauts on Mars wouldn't be so lucky, with astronauts standing a good chance of receiving lethal doses of radiation.

**Editor:** *this assumes that they would not live and work in properly shielded habitat-complexes. But surface activity would be out of the question until the storm was over and if it was a long duration event.##*

## Humans to Mars by 2028 ? Lockheed Martin's Red Planet 'Base Camp' Idea

1 June, 2016 - [www.space.com/32963-mars-base-camp-lockheed-martin-video.html](http://www.space.com/32963-mars-base-camp-lockheed-martin-video.html)

[www.space.com/32974-humans-in-mars-orbit-by-late-2020s-lockheed-martin-concept-video.html](http://www.space.com/32974-humans-in-mars-orbit-by-late-2020s-lockheed-martin-concept-video.html)

Lockheed Martin has launched its campaign to establish a "Mars Base Camp" — a vision for sending humans to Mars by 2028.

In its **Mars Base camp concept** video, the aerospace company Lockheed Martin lays out a plan that would transport astronauts from Earth to a Mars-orbiting science laboratory, where they could perform real-time scientific exploration, analyze Martian rock and soil samples, and confirm the ideal place to land humans on the surface. ##

## SpaceX could send people to Mars by 2024, Elon Musk says

[www.marsdaily.com/reports/SpaceX\\_could\\_send\\_people\\_to\\_Mars\\_by\\_2024\\_Elon\\_Musk\\_says\\_999.html](http://www.marsdaily.com/reports/SpaceX_could_send_people_to_Mars_by_2024_Elon_Musk_says_999.html)

SpaceX Chief Elon Musk is predicting his company will be able to launch humans to Mars by 2024. Musk said if there are no delays, there could be a human colony on Mars by 2025 and promised to give more details of his company's "architecture for Mars colonization" at a global space conference in September.

"What really matters is being able to transport large numbers of people and ultimately millions of tons of cargo to Mars. That's what's necessary in order to create a ... growing city on Mars."

SpaceX announced plans in April to send an unmanned Dragon Version 2 craft to the red planet possibly as soon as 2018, with the goal of landing large payloads there without parachutes or airbags or aerodynamic decelerators.

Musk acknowledged a schedule more ambitious than NASA's, that isn't intending to put a man on Mars until the at least the 2030s. ##

## Mars One 'colonists' to undergo five days of tests

[www.marsdaily.com/reports/Mars\\_colonists\\_to\\_undergo\\_five\\_days\\_of\\_tests\\_999.html](http://www.marsdaily.com/reports/Mars_colonists_to_undergo_five_days_of_tests_999.html)

6 June, 2016 – The 100 candidates on the shortlist to establish a human colony on the planet Mars are to undergo tests as part of a new phase

Around 200,000 hopefuls from 140 countries initially signed up for the Mars One project, which is to be partly funded by a television reality show about the endeavour. This has been whittled down to 100 people. After the five-day third phase of tests, it will be trimmed further to 40, of whom 24 will eventually be chosen for the one-way trips to the red planet, scheduled to start in 2026.

The latest tests, 90 percent of which are those used by NASA, will be done in teams. ##

**Editor:** Most persons familiar with the Mars One plan, dismiss it as a publicity project that has no chance of succeeding. We ourselves have been very critical of the design, pointed out that no attention seems to be given to the location, as if it did not matter. ##

## Dutch crops grown on 'Mars' soil found safe to eat

23 June, 2016 – <http://phys.org/news/2016-06-dutch-crops-grown-mars-soil.html>

Dutch scientists said Thursday crops of four vegetables and cereals grown on soil similar to that on Mars have been found safe to eat, amid plans for the first manned mission to the planet.

## How Big is Mars?

Mars total surface area, all land, is about as large in area as all of Earth's continents together – minus the oceans.

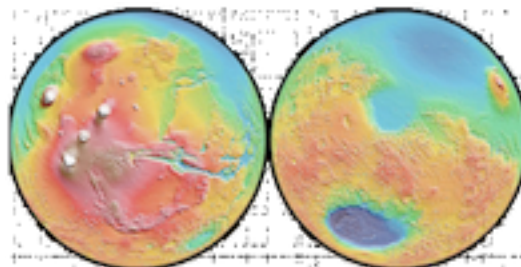

The blue areas are low elevations, some of which may have been water covered at one time, but are all desert now.

## BOOK REVIEW selected by the Editor

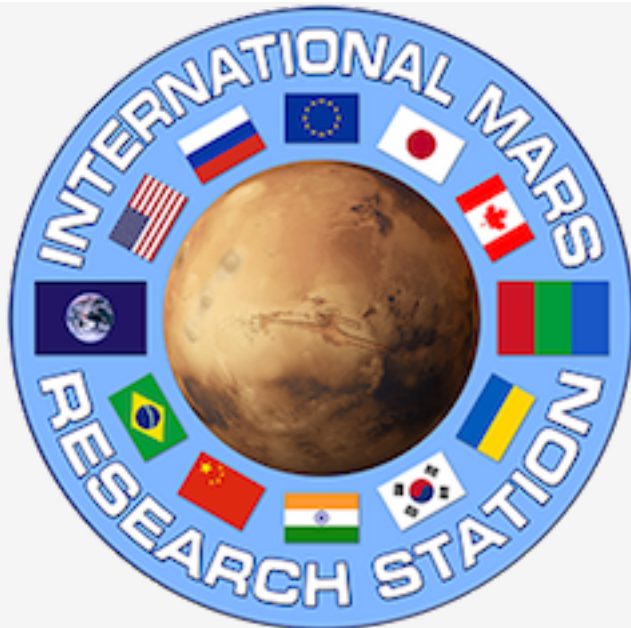

<http://marsbase.org> – Shaun Moss – **International Mars Research Station** – 298pp  
 [Note: this is about a research station on Mars, not in Utah or anywhere else on Earth]

**An exciting new plan to create a permanent human settlement on Mars** contains approximately 300 pages of science, engineering (including detailed drawings of spacecraft), strategy and philosophy, centered on the idea of establishing a research facility on Mars.

The IMRS plan proposes an alliance between the world's **top 10 space agencies** in a similar vein to the International Space Station.

Each mission to the IMRS will be conducted by an international **team of 6 astronauts (3 scientists and 3 engineers)**, progressively building up infrastructure and assets on the Martian surface.

The IMRS plan includes various synergistic measures to maintain affordability, including:

- Spreading the cost among multiple partners
- Focusing on a single location
- Making use of commercial hardware
- Using resources from the Martian environment

#### Other Features

- Modern space hardware such as SpaceX reusable Falcon rockets and Dragon capsules, ##
- Bigelow Aerospace inflatable habitats
- Mechanical counter-pressure spacesuits and NASA's new Space Launch System
- It is more practical than ever before to send humans to Mars; not merely for one, or even a few missions, but an ongoing series of missions that will lay the foundation for permanent human settlement.

Get it: ✓ Amazon kindle: free ✓ Amazon paperback: \$19.99

**Editor's recommendation: 5 star** - I have known Shaun for many years and we have collaborated more than once. He has always been one to say "whoa" to any idea, and rethink it from scratch, casting aside expensive and thoughtless approaches rooted in the mechanics of bureaucracy. This is a credible blueprint of what a first Mars settlement might be like. Compared to Moss' vision, the Mars One project is jibberish. PK





## ASTERIODS

### Asteroid-hunting spacecraft delivers a second year of data

8 April, 2016 – <http://phys.org/news/2016-04-asteroid-hunting-spacecraft-year.html>

Near-Earth Objects (NEOs) are comets and asteroids that have been nudged by the gravitational attraction of the giant planets in our solar system into orbits that enter Earth's neighborhood.

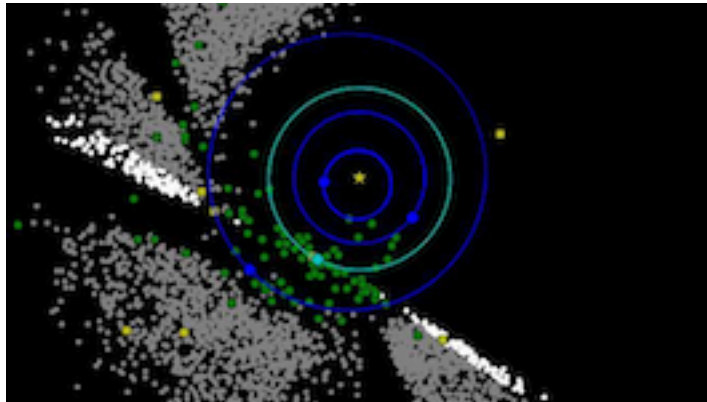

439 asteroids and comets observed by NASA's Near-Earth Object Wide-field Survey Explorer (NEOWISE)  
Of these 72 were new discoveries – ##

### Launch of First U.S. Spacecraft to Sample Asteroid Set for September

[www.nasa.gov/press-release/launch-of-first-us-spacecraft-to-sample-asteroid-set-for-september-nasa-media](http://www.nasa.gov/press-release/launch-of-first-us-spacecraft-to-sample-asteroid-set-for-september-nasa-media) – 29 May 2016

<http://www.space.com/33052-osiris-rex-asteroid-spacecraft-launch-prep.html>

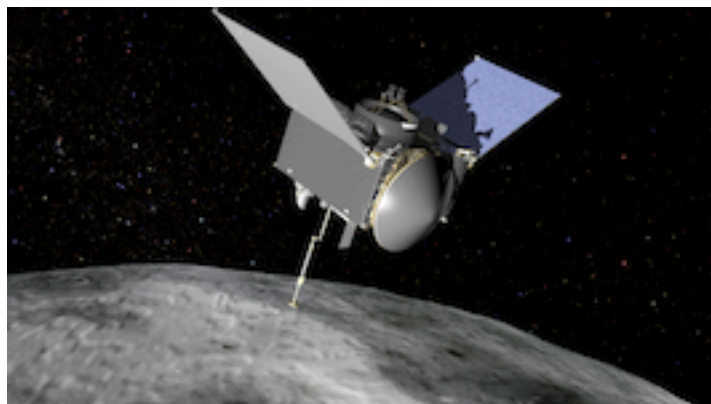

Artist's conception of the OSIRIS-REx spacecraft at Bennu.

OSIRIS-REx is scheduled to launch aboard a United Launch Alliance Atlas V rocket from Space Launch Complex 41 at Cape Canaveral Air Force Station Sept. 8. 2-hour launch window opens at 7:05 p.m. EDT.

## ASTEROID THREATS

### Surprise! Newfound Asteroid Is 'Quasi-Moon' of Earth

16 June 3016 – [www.space.com/33185-earth-quasi-moon-asteroid-2016-ho3.html](http://www.space.com/33185-earth-quasi-moon-asteroid-2016-ho3.html)  
<http://www.jpl.nasa.gov/news/news.php?feature=6537>  
[https://en.wikipedia.org/wiki/\(469219\)\\_2016\\_HO3](https://en.wikipedia.org/wiki/(469219)_2016_HO3)

It seems the Moon is not Earth's only cosmic companion – a small temporarily captive asteroid some 40–100 meters in size (130–330 ft.) is also “looping the Earth.” The newly discovered asteroid 2016 HO3 orbits the sun in such a way that the space rock never strays too far from Earth, making it a “quasi satellite” of Earth.

Calculations indicate 2016 HO3 has been a stable quasi-satellite of Earth **for almost a century**, and it will continue to follow this pattern as Earth's companion **for centuries to come.** Indeed, 2016 HO3 is the best example of an Earth quasi-satellite ever found.



White line is path of Earth around the Sun.

Yellow line is path of newly discovered asteroid 2016 HO3.

Wide yellow loop is apparent path of repeated “orbits” of newly discovered body around Earth.

## CERES

### Graphite Found in Dwarf Planet Ceres and in Pluto Moon Charon

[www.space.com/33223-charon-and-ceres-contain-pencil-graphite.html?cmpid=N\\_L\\_SP\\_weekly\\_2016-6-22](http://www.space.com/33223-charon-and-ceres-contain-pencil-graphite.html?cmpid=N_L_SP_weekly_2016-6-22)

The gray surfaces of the dwarf planet Ceres and Pluto's biggest moon, Charon, both show signs of containing forms of graphite, the material in pencil lead. When NASA's Dawn spacecraft arrived at Ceres last year to embark on an orbital survey, it found a gray, icy world covered with debris left behind by impacts. Spectral observations of the object, which is both a dwarf planet and an asteroid, revealed evidence of a form of graphite called graphitized carbon on its surface.

The dark carbon suggests that similar processes could change the colors of both worlds, though they're significantly different environments. Graphitized carbon forms when carbon is heated to high temperatures in the absence of oxygen.

Throughout Ceres' history, carbon-filled meteorites and asteroids have crashed into the dwarf planet. The solar wind's charged particles have collided with the deposited carbon, repeatedly reprocessing it to release hydrogen and leaving behind a dull, gray graphitized carbon. The dark material has a low albedo, meaning it doesn't reflect a lot of light.

And earlier this year, scientists found that Mercury's surface has high levels of carbon, suggesting that it once boasted a graphite-rich crust. ##

## COMETS

## Team identifies clathrate ices in comet 67P

10 April, 2016 – <http://phys.org/news/2016-04-team-clathrate-ices-comet-67p.html>

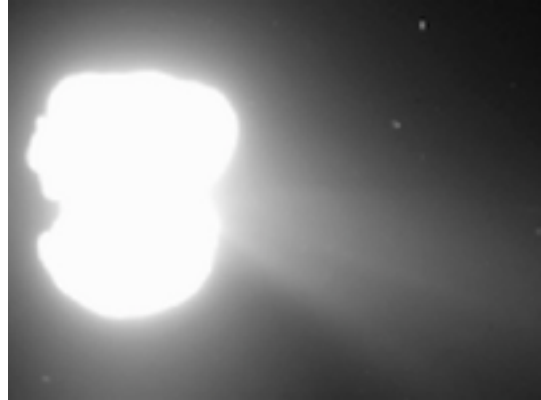

For decades, scientists have agreed that comets are mostly water ice, but what kind of ice—amorphous or crystalline—is still up for debate.

Looking at data obtained by **ESA's Rosetta spacecraft** in the atmosphere, or coma, around comet 67P/Churyumov-Gerasimenko, is evidence of a crystalline form of ice called clathrates.

The structure and phase of the ice tells us a lot about how and where the comet may have formed.

67P likely agglomerated from chunks of ice closer to the Sun in the protosolar nebula. ##

## Comet craters—literal melting pots for life on Earth

4 May, 2016 – <http://phys.org/news/2016-05-comet-cratersliteral-pots-life-earth.html>

Geochemists from Trinity College Dublin's School of Natural Sciences may have found a solution to a long-debated problem as to where – and how – life first formed on Earth.

The team proposes that large meteorite and comet impacts into the sea created structures that provided conditions favourable for life. Water then interacted with impact-heated rock to enable synthesis of complex organic molecules, and the enclosed crater itself was a microhabitat within which life could flourish. ##

## Comet Whips Up Whirling Debris in Close-Up Hubble Telescope View

13 May, 2016 – [www.space.com/32875-comet-whirls-by-hubble-time-lapse.html](http://www.space.com/32875-comet-whirls-by-hubble-time-lapse.html)

[www.space.com/32876-hubble-spies-comet-s-spinning-tail-during-near-earth-fly-by-video.html](http://www.space.com/32876-hubble-spies-comet-s-spinning-tail-during-near-earth-fly-by-video.html)



Hubble Space Telescope captured these images of Comet 252P/LINEAR on April 4, 2016, about two weeks after the object streaked past Earth, using the observatory's Wide Field Camera 3. The comet passed by Earth at a distance of just 5.2 million km (3.3 million mi), c. 14 times the Earth-Moon distance

## Study shows how comets break up, make up

1 June, 2016- <http://phys.org/news/2016-06-comets.html>

[www.space.com/33048-spinning-comets-can-break-apart-reform.html](http://www.space.com/33048-spinning-comets-can-break-apart-reform.html)

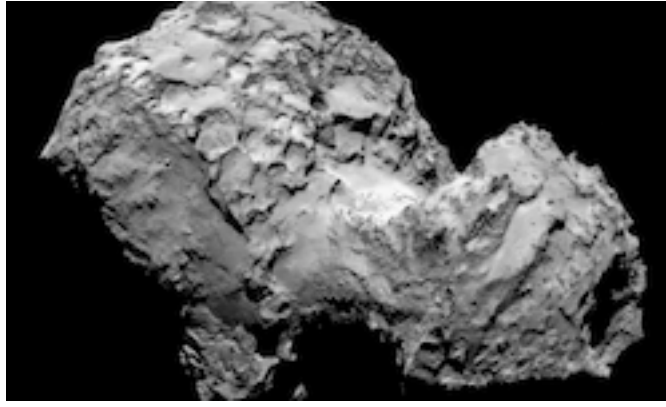

A new study led by Purdue and CU-Boulder researchers shows that comet splitting and reuniting may be fundamental to comet evolution.

For some comets, breaking up is not that hard to do. A new study led by Purdue University and the University of Colorado Boulder indicates the bodies of some periodic comets – objects that orbit the sun in less than 200 years – may regularly split in two, then reunite down the road. ##

## 'Space Selfies' Scrapped, But Asteroid Mining Company Raises \$21M

1, June, 2016- [www.space.com/33043-planetary-resources-ceres-earth-observation-project.html](http://www.space.com/33043-planetary-resources-ceres-earth-observation-project.html)

The asteroid-mining company Planetary Resources recently raised more than \$20 million in venture funding, but also had to shut down a crowdfunded space telescope due to a lack of financial interest. ##

Below: An artist's idea of an asteroid chunk mining operation

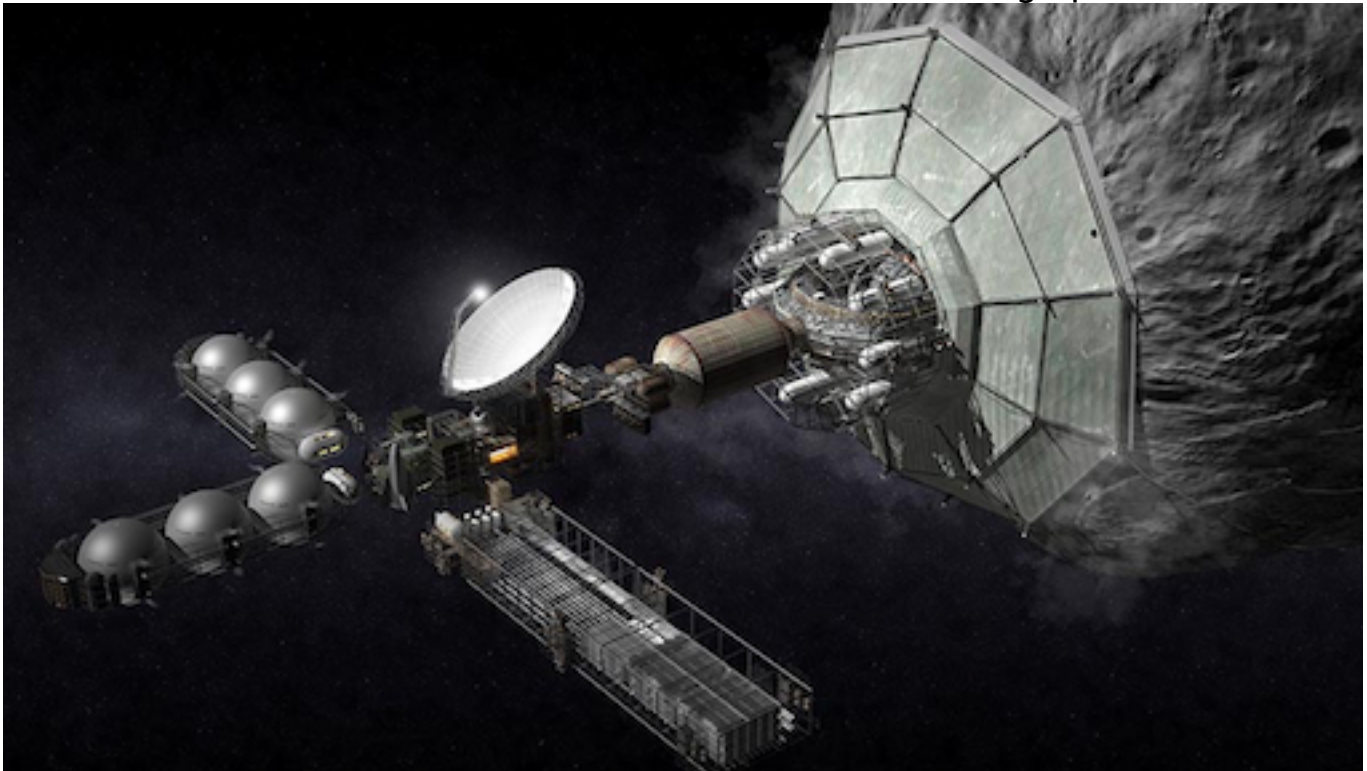

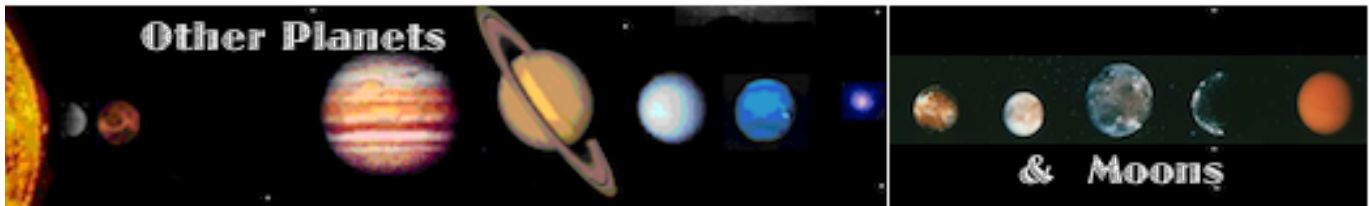

## MERCURY

### Mercury's Global Topography Model Revealed In New Animation

[www.space.com/32814-mercury-s-global-topography-model-revealed-in-new-animation.html](http://www.space.com/32814-mercury-s-global-topography-model-revealed-in-new-animation.html)

[www.space.com/32832-new-mercury-maps-highs-and-lows.html](http://www.space.com/32832-new-mercury-maps-highs-and-lows.html)

<http://www.space.com/17795-mercury-messenger.html>

The first global digital elevation model (DEM) of Mercury is displayed – regions with higher elevations are colored brown, yellow, and red. Lower elevations are colored blue and purple. This stunning look at the planet was created from NASA MESSENGER mission data.

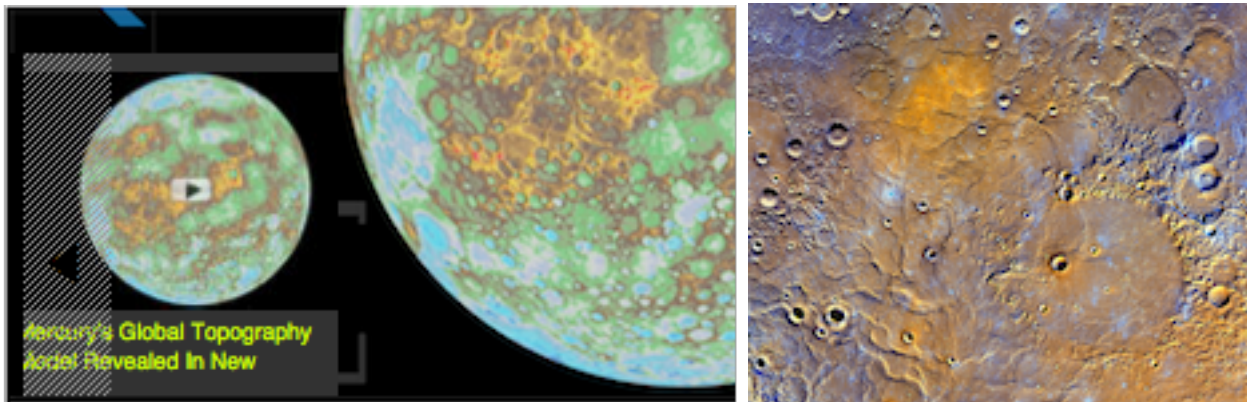

**Left:** The animated image of a rotating Mercury is seen by clicking on the link above.

**Right:** The northern volcanic plains of Mercury dominate this newly released false-color view ##

## VENUS

### Japan's AKATSUKI regular Venus observation to begin in mid April

1 April, 2016 – <http://phys.org/news/2016-04-team-clathrate-ices-comet-67p.html>

[https://en.wikipedia.org/wiki/Akatsuki\\_\(spacecraft\)](https://en.wikipedia.org/wiki/Akatsuki_(spacecraft))

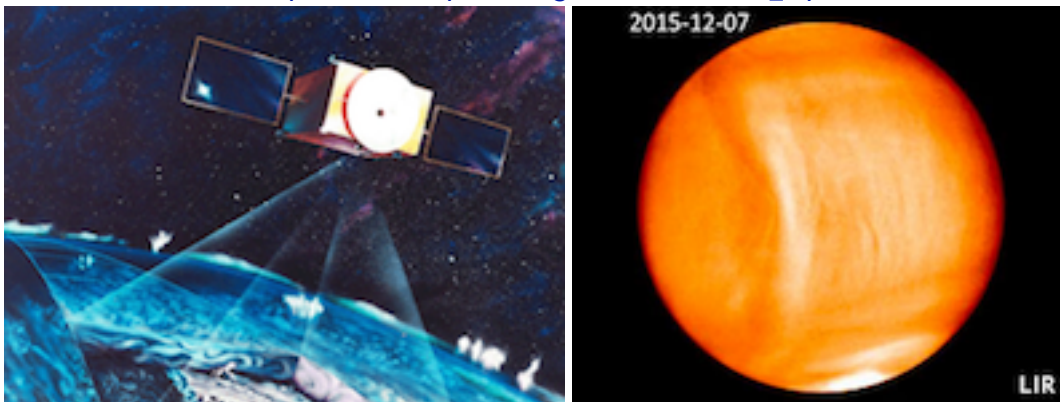

**Image at right:** Test observation results by the Longwave IR camera (LIR) The image shows **bow-shape clouds running from the Southern hemisphere to the Northern one of Venus**. This is the first time to learn such a phenomenon. The minimum goal is to capture Venus's all-globe cloud structure by continuously acquiring image data (every few hours) using onboard cameras from Venus orbit. ##

Past TTSIQ issues are online at: [www.moonsociety.org/international/ttsiq/](http://www.moonsociety.org/international/ttsiq/) and at: [www.nss.org/tothestars/](http://www.nss.org/tothestars/)

## Venus' 'Force Monster' Electric Field Strips Water From Atmosphere | Video

[www.space.com/33220-venus-force-monster-electric-field-strips-water-from-atmosphere-video.html](http://www.space.com/33220-venus-force-monster-electric-field-strips-water-from-atmosphere-video.html) - <http://portaltotheuniverse.org/blogs/posts/view/482826/>



20 June, 2016 – Scientists using data from ESA's **Venus Express** mission have discovered that Venus' 'electric force' or 'electric wind' is far greater than that of Earth. It can overcome gravity's hold on the planet's atmosphere and pushes oxygen out into space. ##

## JUPITER & ITS MOONS

### Juno Spacecraft: NASA's New Mission To Jupiter

28 April, 2016 – [www.space.com/32742-juno-spacecraft.html](http://www.space.com/32742-juno-spacecraft.html)

Jeff Faust comments on goals of Juno – [www.thespacereview.com/article/3016/1](http://www.thespacereview.com/article/3016/1)



Juno is expected to arrive at Jupiter on July 4, 2016. It would be only the 2nd long-term mission at Jupiter after Galileo in the 1990s and 2000s.

**Juno's assignment is to answer the following questions:**

- Does Jupiter have a central core, which will help narrow down how the planet was formed?
- How much water is in its atmosphere, which helps researchers understand how big planets were created?
- How is it possible that giant weather systems remain so stable?
- What is the nature of the magnetic field and plasma surrounding Jupiter?

Juno's mission will last for a much shorter period, targeted to impact Jupiter in February 2018.

### Jupiter Fireballs: Big Impacts Occur 6 to 7 Times Per Year

18 May, 2016 = [www.space.com/32913-jupiter-asteroid-impact-rate-fireballs.html](http://www.space.com/32913-jupiter-asteroid-impact-rate-fireballs.html)

### What's Hiding Below Jupiter's Clouds? Ammonia Swirls

2 June, 2016 – [www.space.com/33058-jupiter-clouds-ammonia-swirls-radio-telescope-map.html](http://www.space.com/33058-jupiter-clouds-ammonia-swirls-radio-telescope-map.html)

Past TTSIQ issues are online at: [www.moonsociety.org/international/ttsiq/](http://www.moonsociety.org/international/ttsiq/) and at: [www.nss.org/tothestars/](http://www.nss.org/tothestars/)

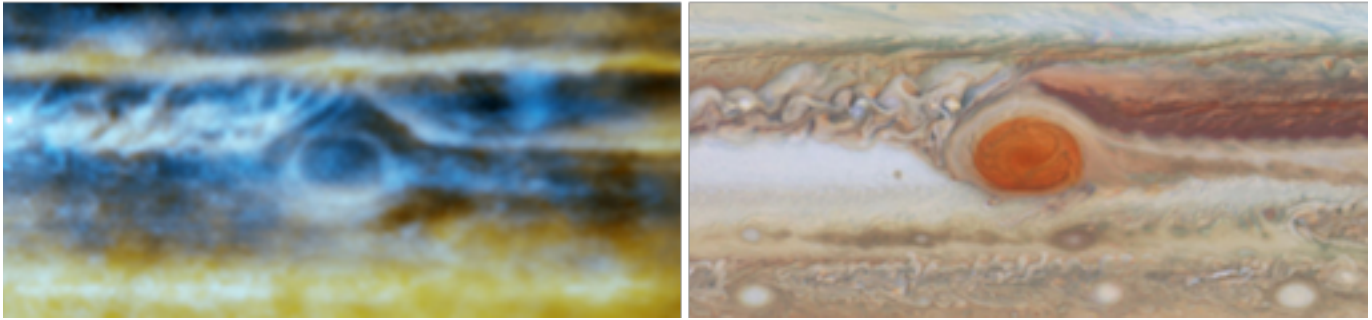

A new radio map of Jupiter, built with data from the Very Large Array in New Mexico, shows the movement of ammonia gas in the planet's atmosphere. **Left** new radio measurements are compared with a visible-light map **Right** from Hubble Space Telescope images, in approximate true color.

"We in essence created a three-dimensional picture of ammonia gas in Jupiter's atmosphere, which reveals upward and downward motions within the turbulent atmosphere." ##

## Mysterious 'Dark Hydrogen' May Lurk Within Giant Planets

28 June, 2016 - [www.space.com/33286-dark-hydrogen-gas-giant-planets.html](http://www.space.com/33286-dark-hydrogen-gas-giant-planets.html)

Exotic "dark hydrogen" lurks within giant planets such as Saturn and Jupiter, a new study suggests. This strange form of hydrogen likely lies between the gaseous hydrogen in the clouds of gas giants such as Saturn and Jupiter and the liquid-metal hydrogen found in these planets' cores. This dark hydrogen layer was unexpected and inconsistent with what modeling research had led us to believe about the change from hydrogen gas to metallic hydrogen inside of celestial objects, ##

## Europa's Deforming Ice Is a Surprising Heat Generator

15 April, 2016 - [www.space.com/32597-europas-deforming-ice-is-a-surprising-heat-generator.html](http://www.space.com/32597-europas-deforming-ice-is-a-surprising-heat-generator.html)

New research into the strange qualities of the moon's cracked crust could reveal some fascinating science about Europa's sub-surface ocean. Researchers have melded observations of Europa with computer models and laboratory experiments to reveal **the tidal compression caused by Jupiter's hefty gravitational field could cause the moon's fragmented ice to generate more heat than thought, creating exciting new implications for the search for European life.**



Europa possesses an extensive sub-surface ocean of water, protected by a fragmented, icy crust that appears to move much like the continental plates on Earth. Tidal pressures created during Europa's orbit around Jupiter create an internal dynamo, which gently heats the moon from the core, maintaining the ocean in a liquid state. In addition, the motion of the icy plates are thought to generate their own heat through frictional processes at the boundaries. ##

## Jupiter Moon Europa's Ocean May Have Enough Energy to Support Life

26 May, 2016 - [www.space.com/32995-jupiter-moon-europa-energy-life.html](http://www.space.com/32995-jupiter-moon-europa-energy-life.html)

A salty ocean of liquid water is believed to lie beneath Europa's icy exterior. This ocean could be habitable, if it harbors the required chemical building blocks and the right proportion of elements to

Past TTSIQ issues are online at: [www.moonsociety.org/international/ttsiq/](http://www.moonsociety.org/international/ttsiq/) and at: [www.nss.org/tothestars/](http://www.nss.org/tothestars/)

provide energy for biological systems — the right ratio of oxygen to hydrogen, for example. The new study suggests that there is, indeed, enough of that energy.



Europa's surface is covered with cracks - **Editor:** the significant color difference would seem to come from chemicals (and possible life forms) in Europa's global ocean.

## Europa: Facts About Jupiter's Icy Moon and Its Ocean

13 June, 2016 - [www.space.com/15498-europa-sdcmp.html](http://www.space.com/15498-europa-sdcmp.html)

### Facts about Europa

**Age:** Europa is estimated to be about 4.5 billion years old, about the same age of Jupiter.

**Distance from the sun:** On average, Europa's distance from the sun is about 485 million miles (or 780 million kilometers).

**Distance from Jupiter:** Europa is Jupiter's sixth satellite. Its orbital distance from Jupiter is 414,000 miles (670,900 km). It takes Europa three and a half Earth-days to orbit Jupiter. Europa is tidally locked, so the same side faces Jupiter at all times.

**Size:** Europa is 1,900 miles (3,100 km) in diameter, making it smaller than Earth's moon, but larger than Pluto. It is the smallest of the Galilean moons.

**Temperature:** Europa's surface temperature at the equator never rises above minus 260 degrees  Fahrenheit (minus 160 degrees Celsius). At the poles of the moon, the temperature never rises above minus 370 F (minus 220 C)

## Ganymede: Facts About Jupiter's Largest Moon

15 June, 2016 - [www.space.com/16440-ganymede-facts-about-jupiters-largest-moon.html](http://www.space.com/16440-ganymede-facts-about-jupiters-largest-moon.html)

**Age:** Ganymede is about 4.5 billion years old, about the same age as Jupiter.

**Distance from Jupiter:** Ganymede is the 7th moon and 3rd Galilean satellite outward from Jupiter, orbiting at about 665,000 mi (1.070 million km). It takes Ganymede about 7 Earth-days to orbit Jupiter

**Size:** Ganymede's mean radius is 1,635 miles (2,631.2 km). Although Ganymede is larger than Mercury it only has half its mass, classifying it as low density.

**Temperature:** Daytime temperatures on the surface average =171 to -297 °F and night temperatures drop to -193 °C. In 1996, the Hubble Space Telescope found evidence of a thin oxygen atmosphere, too thin to support life as we know it; it is unlikely that any living organisms inhabit Ganymede.

**Magnetosphere:** Ganymede is the only satellite in the solar system to have a magnetosphere. Typically found in planets, including Earth and Jupiter, a magnetosphere is a comet-shaped region in which charged particles are trapped or deflected. Ganymede's magnetosphere is entirely embedded within the magnetosphere of Jupiter.

### Discovery and exploration of Ganymede

Ganymede was discovered by Gallileo Galilei on Jan. 7, 1610. The discovery, along with three other Jovian moons: Callisto, Europa, and Io (progressively closer to Jupiter), was the first time a moon was discovered orbiting a planet other than Earth. Galileo's discovery eventually led to the understanding that planets orbit the sun, instead of our solar system revolving around Earth.



Galileo called this moon Jupiter III. When the numerical naming system was abandoned in the mid-1800s, the moon was named after Ganymede, a Trojan prince in Greek mythology. Zeus, a counterpart of Jupiter in Roman mythology, carried Ganymede, who had taken the form of an eagle, to Olympus, where he became a cupbearer to the Olympian gods and one of Zeus' lovers.

Several spacecraft have flown by Jupiter and its moons. Pioneer 10 in 1973, Pioneer 11 in 1974. Voyager 1 and Voyager 2 returned striking photos during their flybys. The Galileo spacecraft passed as low as 162 miles (261 km) over the surfaces of the Galilean moons and produced detailed images.

The European Space Agency plans a mission called **JUICE** (JUperiter ICy moons Explorer) that would launch from Earth in 2022 for arrival at Jupiter in 2030. While the mission will look at three moons (Ganymede, Callisto and Europa), Ganymede will be the focus because it shows how icy worlds evolve and could be habitable in general. Scientists will try to figure out more about its ocean and icy crust, map its surface in detail, learn about the interior, probe the atmosphere and study the magnetic field.

**Ganymede's surface** is made up of primarily two types of terrain: about 40 % is dark with numerous craters, and 60 % is lighter in color with grooves that form intricate patterns to give the satellite its distinctive appearance. The grooves were likely formed as a result of tectonic activity or water being released from beneath the surface, and are as high as 2,000 ft and stretch for thousands of miles. ##

## How to Form Io's Mountains? Just Squeeze!

23 May, 2016 - [www.space.com/32957-how-to-form-ios-mountains-just-squeeze.html](http://www.space.com/32957-how-to-form-ios-mountains-just-squeeze.html)

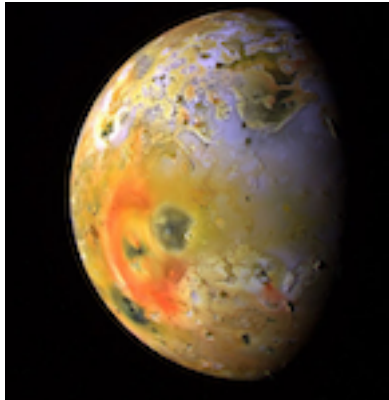

Jupiter's moon Io is a hotbed of volcanic activity and much of its geology remains a mystery.

How Io's mountains were formed has puzzled scientists for decades because they look nothing like mountains on Earth where we see mountains grow in ranges that can stretch across thousands of miles. But on Io, the more than 100 cataloged mountains mostly grow in isolation. What mysterious tectonic forces are at play here?

A new study used simulations to figure things out. "All that lava spewed on the surfaces pushes downward and, as it descends, there's a space problem because Io is a sphere, so you end up with compressive forces that increase with depth."

All that lava spewed on the surfaces pushes downward and, as it descends, there's a space problem because Io is a sphere, so you end up with compressive forces that increase with depth." This could explain why so many recent eruptions are found near the mountains. ##

## SATURN & ITS MOONS

### Saturn Cassini Spacecraft Samples Interstellar Dust

15 April, 2016 - [www.spacedaily.com/reports/Saturn\\_Spacecraft\\_Samples\\_Interstellar\\_Dust\\_999.html](http://www.spacedaily.com/reports/Saturn_Spacecraft_Samples_Interstellar_Dust_999.html)

The Cassini spacecraft has detected the faint but distinct signature of dust coming from beyond our solar system. It sampled millions of ice-rich dust grains with its cosmic dust analyzer instrument. The vast majority of the sampled grains originate from active jets that spray from the surface of Saturn's geologically active moon Enceladus.

But among the myriad microscopic grains collected by Cassini, a special few – just 36 grains – stand out from the crowd. Scientists conclude these specks of material came from interstellar space – the space between the stars.

Alien dust in the solar system is not unanticipated. ##

## Excitement Builds for the Possibility of Life on Enceladus

[www.scientificamerican.com/article/excitement-builds-for-the-possibility-of-life-on-enceladus/](http://www.scientificamerican.com/article/excitement-builds-for-the-possibility-of-life-on-enceladus/)

26 June, 2016 – Saturn's frozen moon Enceladus is a tantalizing world—many scientists are increasingly convinced it may be the best place in our solar system to search for life. NASA's Cassini spacecraft, currently orbiting Saturn, has made intriguing observations of icy jets spewing from a suspected underground liquid ocean on the mysterious world that might be hospitable to alien life.

Cassini's tour is due to wind down in 2017, and **scientists badly want to send a dedicated mission to Enceladus to look for signs of life. In fact, some have already started seriously thinking about exactly how they might do this.** ##

## TITAN

### Cassini Spies Titan's Tallest Peaks

28 March, 2016 – [www.spacedaily.com/reports/Cassini\\_Spies\\_Titans\\_Tallest\\_Peaks\\_999.html](http://www.spacedaily.com/reports/Cassini_Spies_Titans_Tallest_Peaks_999.html)

Titan's tallest peak is **3,337 m {10,948 ft}** high and is found within a trio of mountainous ridges called the Mithrim Montes. The researchers found that all of Titan's highest peaks are about 3,000 m (10,000 ft) in elevation. The study used images and data from Cassini's radar instrument, which can peer through the obscuring smog of Titan's atmosphere to reveal the surface in detail. ##

### Working Toward 'Seamless' Infrared Maps of Titan Titan's Hidden Surface: Global Map Shows New Details

28 March [www.spacedaily.com/reports/Working\\_Toward\\_Seamless\\_Infrared\\_Maps\\_of\\_Titan\\_999.html](http://www.spacedaily.com/reports/Working_Toward_Seamless_Infrared_Maps_of_Titan_999.html)

1 April, 2016 – [www.space.com/32437-titan-hidden-surface-global-map.html](http://www.space.com/32437-titan-hidden-surface-global-map.html)

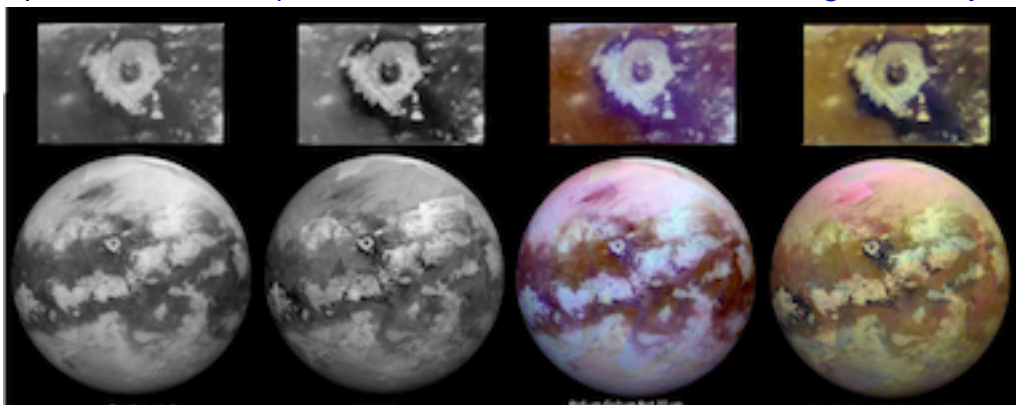

New views of Saturn's largest moon, Titan, combine **infrared photographs** taken by the Cassini spacecraft's Visual and Infrared Mapping Spectrometer that pierce the moon's dense haze. The **top photos** in each of the composite maps show a **close-up of the 50-mile-wide (80-kilometer-wide) Sinlap impact crater.**

These views demonstrate some of the progress researchers have made in creating smooth-looking maps of Titan from the multitude of different VIMS observations made under a wide variety of lighting and viewing conditions.

New composite images could reveal some of the hidden features of this fascinating moon. The Visual and Infrared Mapping Spectrometer (VIMS) on board NASA's Cassini spacecraft is one of the few instruments that can see through it to probe the surface below. ##

## Discovering the bath scum on Titan

1 April, 2016 – <http://phys.org/news/2016-04-scum-titan.html>

[www.spacedaily.com/reports/Discovering\\_the\\_bath\\_scum\\_on\\_Titan\\_999.html](http://www.spacedaily.com/reports/Discovering_the_bath_scum_on_Titan_999.html)

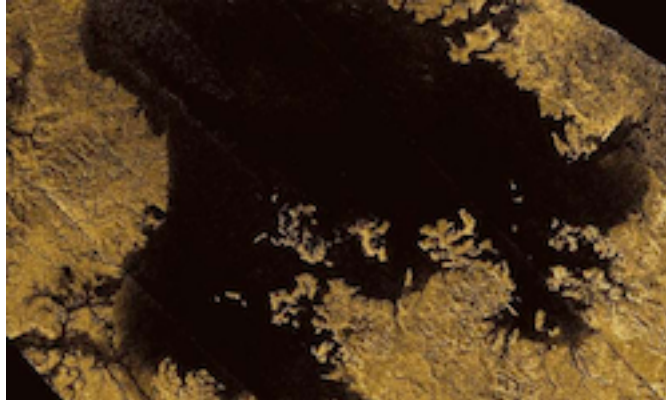

Titan's Ligeia Mare in false color

Cassini has also spotted dried lakes – full of material that is different to the surrounding terrain. This is like something we see on Earth – for example in the Australian red centre. On Earth we know what materials fill these lakes, they are salts and hydrates – materials with water trapped in their structure. But what are they on Titan? What scum gets left behind when the lakes of Titan evaporate?

## Profile of a Methane Sea on Titan

[www.esa.int/Our\\_Activities/Space\\_Science/Cassini-Huygens/Profile\\_of\\_a\\_methane\\_sea\\_on\\_Titan](http://www.esa.int/Our_Activities/Space_Science/Cassini-Huygens/Profile_of_a_methane_sea_on_Titan)

26 April, 2016 – Saturn's largest moon is covered in seas and lakes of liquid hydrocarbons – and one sea, **Ligeia Mare**, (see photo above) has now been found to be filled with **pure methane**, with a **seabed covered by a sludge of organic-rich material**, and **possibly surrounded by wetlands**. ##

## Exploring Titan Via Submarine – 'Space's Deepest Secrets' Show Clip Could a Sub Explore the Seas of Saturn's moon Titan?

[www.space.com/32887-spaces-deepest-secrets-titan-submarines-exclusive-clip.html](http://www.space.com/32887-spaces-deepest-secrets-titan-submarines-exclusive-clip.html)

[www.space.com/32886-exploring-saturn-moon-titan-via-submarine-spaces-deepest-secrets-clip.html](http://www.space.com/32886-exploring-saturn-moon-titan-via-submarine-spaces-deepest-secrets-clip.html) – 16 May, 2016



For an image with labeled parts, go to:

[www.nasa.gov/sites/default/files/thumbnails/image/oleson\\_external\\_components\\_titan\\_sub.jpg](http://www.nasa.gov/sites/default/files/thumbnails/image/oleson_external_components_titan_sub.jpg)

## ENCELADUS

**Computer model explains sustained eruptions on icy Enceladus**

28 March, 2016 - <http://phys.org/news/2016-03-sustained-eruptions-icy-moon-saturn.html>

The Cassini spacecraft has observed geysers erupting on Saturn's moon Enceladus since 2005, but the process that drives and sustains these eruptions has remained a mystery. On Earth, eruptions don't tend to continue for long. When we do see eruptions that continue for a long time, they'll be localized into a few pipelike eruptions with wide spacing between them.

Enceladus probably has an ocean underlying its icy surface, and has sprouted multiple fissures along its south pole. These eruptions have continued for decades and probably much longer.

We ca't yet explain why the fissure system doesn't clog up with its own frost, and why the energy removed from the water table by evaporative cooling doesn't just ice things over." ##

**Saturn Moon Enceladus Surprising Geysers Hint at Plumbing Mystery**

10 May, 2016 [www.space.com/32844-saturn-moon-enceladus-surprising-plumbing-mystery.html](http://www.space.com/32844-saturn-moon-enceladus-surprising-plumbing-mystery.html)

A small water jet on Enceladus, an icy moon of Saturn. The moon spews its fiercest eruptions when it is farthest from Saturn, but the overall gas output doesn't increase much during that time. The study points to a mystery in Enceladus' plumbing. More than 90% of the material in the observed plumes contains water vapor. ##

**Saturn Moon Enceladus' Plumes May Resemble Earth's 'Lost City'**

29 June, 2016 - <http://www.space.com/33294-enceladus-may-resemble-earth-lost-city.html>

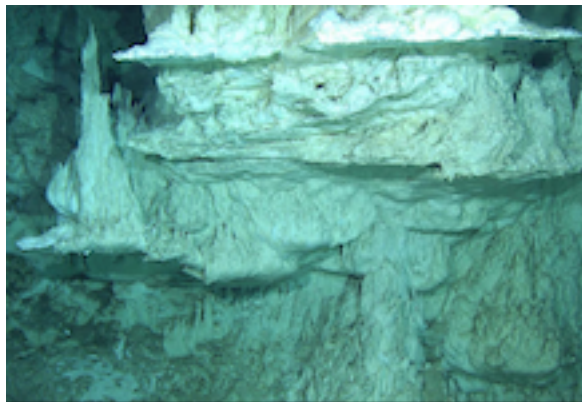

Active vents from Earth's Lost City hydrothermal vents could be similar to features found in the ocean of Enceladus. ##

## NEPTUNE

**Neptune Sports Dark Vortex, Hubble Images Reveal**

[www.space.com/33265-neptune-dark-vortex-identified.html](http://www.space.com/33265-neptune-dark-vortex-identified.html)

<http://phys.org/news/2016-06-image-hubble-dark-neptune.html>

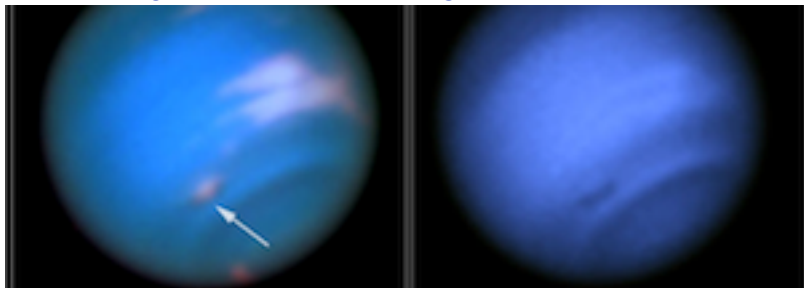

Neptune is sporting a new spot, the first one identified in the 21st century. NASA's Hubble Space Telescope confirmed the existence of the high-pressure system known as a dark vortex after bright clouds hinted at its presence. Dark vortices coast through the atmosphere like huge, lens-shaped gaseous mountains, and the companion clouds are similar to so-called organic clouds that appear as pancake-shaped features lingering over mountains on Earth,

## PLUTO -CHARON

### Pluto-Charon meets the definition of a binary planet

<http://solarsystem.nasa.gov/news/2006/08/17/what-is-a-binary-planet>

"Binary planet" is a term often used to describe any pair of worlds that are similar in mass. Each orbits the other around a gravitational balance point that is between the two – a location called the center of mass. "In the case of Pluto and Charon, separated by 17 Pluto radii, the ratio of their masses is 8:1 so that the center of mass is outside Pluto."

### New Horizons imagery reveals small, frozen lake on Pluto

28 March, 2016 - <http://phys.org/news/2016-03-horizons-imagery-reveals-small-frozen.html>

New Horizons spacecraft spied several features on Pluto that offer evidence of a time millions or billions of years ago when, with much higher pressure in Pluto's atmosphere and warmer conditions on the surface – liquids might have flowed across and pooled on the surface.

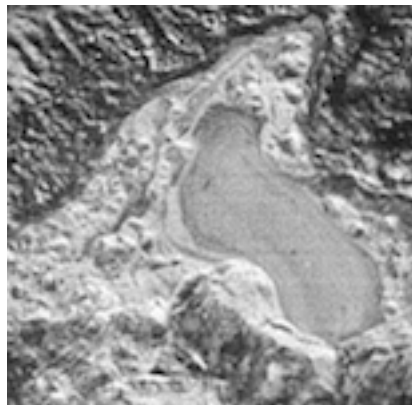

This feature appears to be a frozen, former lake of liquid nitrogen, located in a mountain range just north of Pluto's Sputnik Planum. It shows details as small as about 130 m (430 ft). At its widest point the "lake" appears to be about 20 miles (30 kilometers) across. ##

### Researchers study Charon's internal evolution

March 22, 2016 - <http://phys.org/news/2016-03-charon-internal-evolution.html>

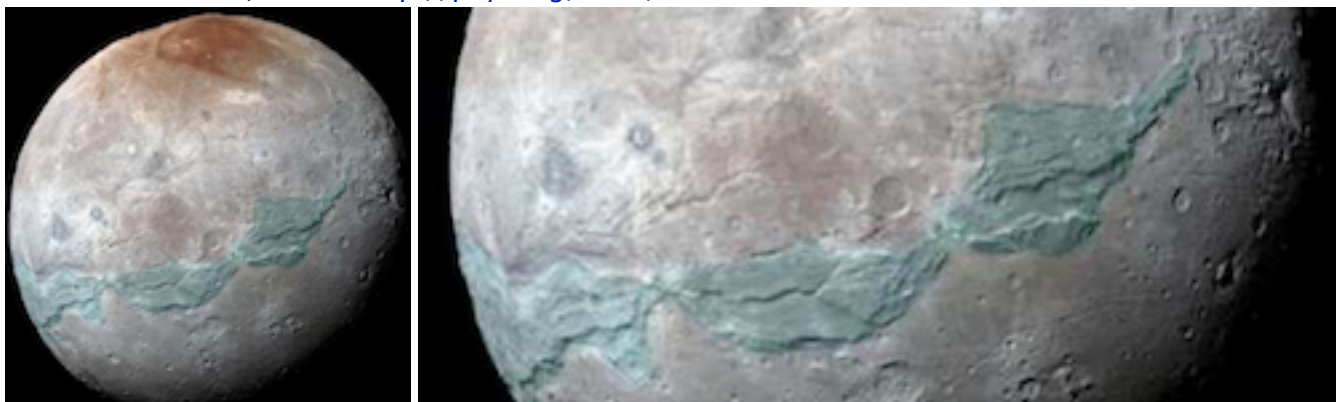

Charon and its tectonic belt marked in light blue

NASA's New Horizons mission provided invaluable information about Pluto's moon Charon and delivered detailed images of this unique and interesting rocky body.

But many mysteries still lie unresolved beneath its frigid surface. Recently, a team of scientists sought to solve one of Charon's secrets by creating a model that explains its internal evolution. ##

## Icy 'Spider' on Pluto

8 April, 2016 - [www.spacedaily.com/reports/Icy\\_Spider\\_on\\_Pluto\\_999.html](http://www.spacedaily.com/reports/Icy_Spider_on_Pluto_999.html)

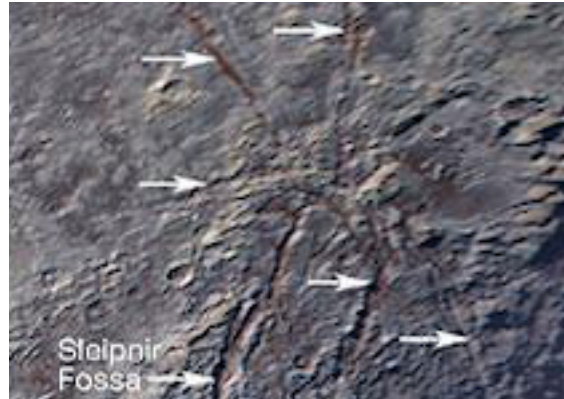

Pluto's unusual spider-like feature consists of at least six extensional fractures that converge to a point. Individual fractures can reach hundreds of miles long and appear to expose a reddish subsurface layer.##

## NASA invests in technology to revisit Pluto-Charon

[www.spacedaily.com/reports/NASA\\_Invests\\_in\\_Two\\_Dimensional\\_Spacecraft\\_Reprogrammable\\_Microorganisms\\_999.html](http://www.spacedaily.com/reports/NASA_Invests_in_Two_Dimensional_Spacecraft_Reprogrammable_Microorganisms_999.html)

12 April, 2016 - Among 13 proposals through NASA Innovative Advanced Concepts (NIAC), a program that invests in transformative architectures through the development of pioneering technologies, is a **Fusion-Enabled Pluto Orbiter and Lander**. ##

## Mysterious 'Haloed' on Pluto Puzzle Scientists

27 April, 2016 - [www.space.com/32710-pluto-halo-craters-mystery-new-horizons.html](http://www.space.com/32710-pluto-halo-craters-mystery-new-horizons.html)



Strange "haloed" craters can be seen on Pluto in these images of Pluto from NASA's New Horizons probe. Dozens of the strange craters are visible in the black-and-white view (left), while the right view shows strange methane ice (in purple) around the craters, with water ice (in blue) inside and around them. ##

## Scientists assemble fresh global map of Pluto from sharpest flyby images

2 May, 2016 - <http://phys.org/news/2016-05-scientists-fresh-global-pluto-comprising.html>

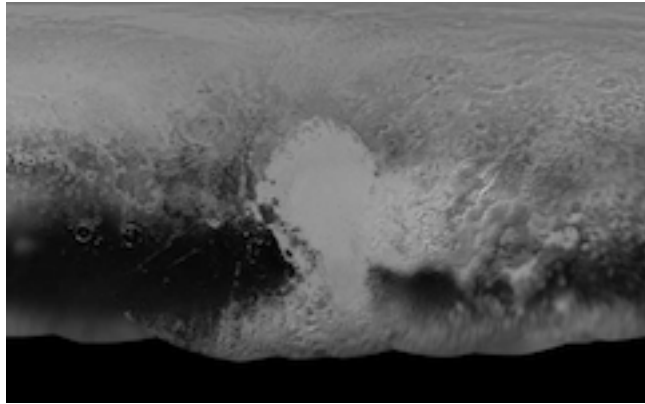

Full size image: <http://cdn.phys.org/newman/csz/news/800/2016/scientistsas.jpg>

The newly updated global Pluto map is comprised of all the highest resolution images transmitted back to Earth thus far and provides the best perspective to date. ##

## Pluto's Hazy Layers Linked to Atmospheric Gravity Waves

4 May, 2016 - [www.space.com/32778-pluto-hazy-layers-linked-to-gravity-waves.html](http://www.space.com/32778-pluto-hazy-layers-linked-to-gravity-waves.html)

<http://phys.org/news/2016-05-pluto-interactions-solar-unique.html>

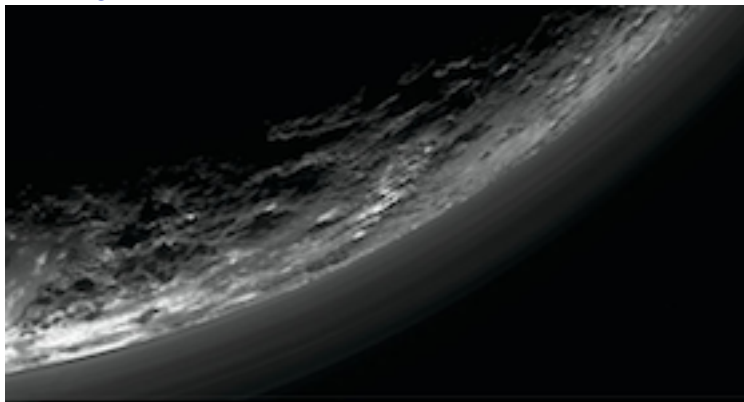

Layering in Pluto's atmosphere may form thanks to gravity waves

Streaks seen in the slightly hazy atmosphere of Pluto may arise because of a phenomenon known as buoyance waves, also known as gravity waves. While scientists recently made headlines with the discovery  of “gravitational” waves — ripples in space-time created by energetic events such as colliding black holes, “gravity: waves? are something entirely different – “atmospheric buoyancy waves.”

The gravity waves on Pluto form in a similar way, Strobel said. On Pluto's surface, materials go through sudden changes — ices transform into gas without first melting into a liquid (in a process known as sublimation), and gases become solid through a process called deposition. These events create forces that push against the atmosphere, ##

## Pluto's interactions with the solar wind are unique, study finds

4 May, 2016 - <http://phys.org/news/2016-05-pluto-interactions-solar-unique.html>

## Pluto Behaves More Like a Planet Than Thought

10 May, 2016 - [www.space.com/32834-pluto-behaves-more-like-a-planet-than-thought.html](http://www.space.com/32834-pluto-behaves-more-like-a-planet-than-thought.html)

Researchers have found a way in which this ever-surprising world acts more planet-like than dwarf-like: **how it interacts with the solar wind.**

During New Horizons' flyby through the Plutonian system in July 2015, the spacecraft's Solar Wind Around Pluto (SWAP) instrument measured what happens when charged particles streaming out from the sun interact with Pluto's atmosphere.

What was observed was a much less subtle comet-like interaction (as had been previously suspected) and more a hybrid comet/planet behavior, with the solar wind being deflected abruptly but relatively close to its upwind-facing surface – “a type of interaction we've never seen before anywhere in our solar system”. ##

## Pluto's Moon Hydra Sheathed in Ultraclean Water Ice

10 May, 2016 – [www.space.com/32848-pluto-moon-hydra-water-ice.html](http://www.space.com/32848-pluto-moon-hydra-water-ice.html)

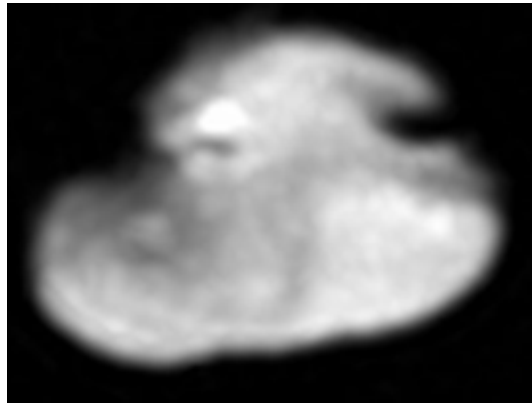

Hydra, Pluto's outermost moon, is about 50 kms (31 mi) in diameter

Hydra, was named for a legendary Greek water monster: New data show that the little moon is almost entirely covered in "nearly pristine" water ice, NASA officials say.

The new data from the New Horizons spacecraft suggest that the planet's icy shell is cleaner than the ice found on Pluto's other moons, even more so than Pluto's binary planet partner, Charon. ##

## Weird Shapes on Pluto Hint at Icy 'Face-Lift' Over Time

1 June, 2016 = [www.space.com/33046-weird-pluto-polygons-surface-facelift-explained.html](http://www.space.com/33046-weird-pluto-polygons-surface-facelift-explained.html)

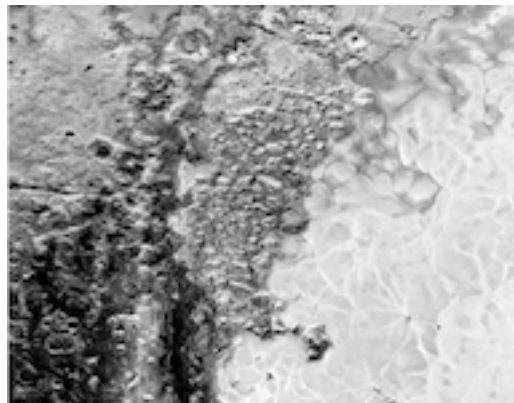

The strange polygon-shaped terrain on Pluto can be seen clearly on the right side of this image captured by NASA's New Horizons spacecraft during its historic flyby on July 14, 2015. Scientists say the strange shapes are signs of geologic activity from churning nitrogen ice that can change the face of Pluto over time.

Strange geometric shapes miles wide seen on Pluto's icy surface likely formed because of a churning sheet of frozen nitrogen more than a half-mile thick, two new studies find. The findings reinforce the idea that Pluto is not cold and dead but surprisingly geologically active, ##

**EDITOR:** The astronomer cabal that in 2006 demoted Pluto to a Dwarf Planet of the Kuiper Belt Objects population did not stop to consider whether a body with an active interior should perhaps be classified as a planet. And as a "binary planet" to boot. Pluto-Charon is too amazing and complex to be dismissed/ #

Past TTSIQ issues are online at: [www.moonsociety.org/international/ttsiq/](http://www.moonsociety.org/international/ttsiq/) and at: [www.nss.org/tothestars/](http://www.nss.org/tothestars/)



## Pluto's 'Lord Of The Underworld' Highlands In New Color Imagery | Video

[www.space.com/33141-pluto-s-lord-of-the-underworld-highlands-in-new-color-imagery-video.html](http://www.space.com/33141-pluto-s-lord-of-the-underworld-highlands-in-new-color-imagery-video.html)



A new enhanced color view of Pluto's great ice plains (southeast portion) was created by combining the NASA New Horizons' Long Range Reconnaissance Imager (LORRI) image with Ralph/Multispectral Visual Imaging Camera (MVIC) data. The rugged highland features in the image are informally named Krun Macula – Krun is in reference to the "lord of the underworld in the Mandaean religion and a 'Macula' is a dark region on a planetary surface," according to NASA. ##

## Graphite Found at Pluto Moon Charon and Dwarf Planet Ceres

[/www.space.com/33223-charon-and-ceres-contain-pencil-graphite.html?cmpid=NL\\_SP\\_weekly\\_2016-6-22](http://www.space.com/33223-charon-and-ceres-contain-pencil-graphite.html?cmpid=NL_SP_weekly_2016-6-22) – 22 June, 2016 –

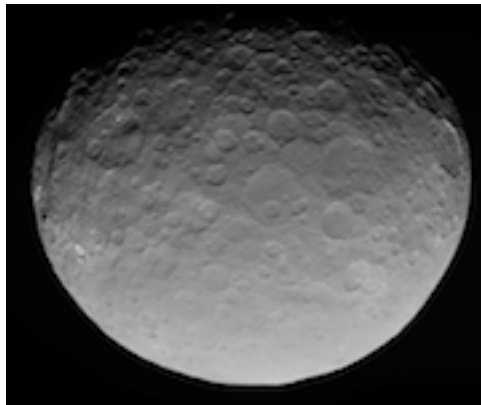

The gray surfaces of the dwarf planet Ceres and Pluto's biggest moon, Charon, both show signs of containing forms of graphite, the material in pencil lead. And earlier this year, scientists found that Mercury's surface has high levels of carbon, suggesting that it once boasted a graphite-rich crust.

Only a few months after Dawn reached Ceres, NASA's New Horizons spacecraft flew by Pluto and revealed that its binary companion, Charon, has a grayish appearance. That color could have been caused by graphite on the moon's surface, according to lab results presented at the conference by Dale Cruikshank, a planetary scientist at NASA's Ames Research Center.

The presence of graphite at Charon presents a puzzle because New Horizons didn't spot carbon on Charon, but it did so at Pluto.

Before New Horizons arrived at Pluto, scientists hypothesized that the dwarf planet shared its atmosphere with its largest moon, and observations made by the spacecraft seem to confirm it. So carbon may travel from Pluto over to Charon. But although it is mostly gray, Charon also boasts a bright-red spot at its pole. ##

## Pluto May Harbor a Liquid Ocean

21 June, 2016 – <http://phys.org/news/2016-06-bolsters-case-present-day-subsurface-ocean.html>

23 June, 2016 – <http://www.space.com/33256-pluto-may-harbor-liquid-ocean.html>

The underground ocean that produced some of the stunning features on Pluto's surface may still be splashing around beneath the crust today. If Pluto's subsurface ocean had frozen over completely, it would have formed highly pressurized ice that would have caused the dwarf planet to shrink, according to new research. [research](#). The canyons and valleys on Pluto seem to have formed as the dwarf planet swelled up, rather than as it shrank, indicating that a liquid ocean most likely sits beneath the thick ice crust today, researchers said in the study.

When the New Horizons probe flew past Pluto last July, its images of the dwarf planet's surface revealed deep faults, or fractures in the surface, hundreds of kilometers long. The long canyons appeared to form as Pluto's crust expanded, Hammond said. "A subsurface ocean that was slowly freezing over would cause this kind of expansion . ##

## BEYOND PLUTO-CHARON – KUIPER BELT OBJECTS

### New Horizons Encore? Pluto probe team proposes 2<sup>nd</sup> extension

<http://www.space.com/32660-new-horizons-extended-mission-kuiper-belt.html>

25 April, 2016 – The "Kuiper Belt Extended Mission" (KEM) is so named because it would continue to explore the Kuiper Belt, the ring of icy bodies beyond Neptune's orbit — sending New Horizons zooming past a small object, 2014 MU69, on January 1, 2019 at a distance of 3,000 km {1,900 mi}, about four times closer than it flew past the Pluto-Charon binary planet. This object is between 21–40 km (13–25 mi) wide. Imaging and compositional mapping spectroscopy resolutions are all expected to be even better than that achieved at the Pluto-Charon system.

2014 MU69 lies about 1.6 billion km (1 billion mi) beyond Pluto's orbit.

New Horizons would also conduct 16 to 20 "distant flybys" of other Kuiper Belt objects (KBOs) and search for rings around a number of KBOs from 2016 through 2020. ##

### Distant Dwarf Planet Makemake has Its own moon! – Video

26 April, 2016 = [www.space.com/32702-dwarf-planet-makemake-moon-hubble-discovery.html](http://www.space.com/32702-dwarf-planet-makemake-moon-hubble-discovery.html)  
<https://en.wikipedia.org/wiki/Makemake>

Astronomers using NASA's Hubble Space Telescope have discovered a moon orbiting Makemake, the second-brightest object in the distant Kuiper Belt beyond Neptune (after Pluto.)

This moon is 1,300 times fainter than the Makemake and is thought to be about 160 km (100 m) in diameter. The moon was spotted 20,900 km (13,000 mi) from the surface of Makemake, which itself is 1,400 km (870 mi) wide, about 2/3 the diameter of Pluto.

Makemake's orbit ranges from 38.59 AU (Astronomical Unit – the average distance of Earth from the Sun) to 52.84 – in comparison to Pluto-Charon's distance ranging from 26.9 to 49.3 AU.

Pluto-Charon makes one orbit around the Sun in 245 years

Makemake makes one orbit around the Sun in 309 years ##

### Mysterious Dwarf Planet 'Snow White' Much Bigger Than Thought: Study

12 May, 2016 – [www.space.com/32863-dwarf-planet-snow-white-size-revision.html](http://www.space.com/32863-dwarf-planet-snow-white-size-revision.html)

A faraway object nicknamed "Snow White" is considerably larger than scientists had thought, in fact, the 3rd-largest dwarf planet in the solar system.

"Snow White" is about 1,535 km (955 mi) in diameter rather than 1,280 km (795 mi) wide as previously believed, making it the largest still-unnamed object in our solar system.

The dwarf planet currently goes by the placeholder designation **2007 OR10**. ##\

## Beyond Pluto, New Horizons Studies Distant Icy Object

23 May, 2016 = [www.space.com/32946-new-horizons-probes-object-beyond-pluto.html](http://www.space.com/32946-new-horizons-probes-object-beyond-pluto.html)  
[https://en.wikipedia.org/wiki/\(15810\)\\_1994\\_JR1](https://en.wikipedia.org/wiki/(15810)_1994_JR1)

New Horizons finished its close encounter with Pluto last July and since then has completed two sets of observations on an object in the Kuiper Belt, the band of objects beyond the orbit of Neptune. The icy body is known as **1994 JR1** and orbits about 32 times Earth's distance from the Sun. The 150 km (90-mi)-wide object is rotating, using observations taken in April. Changes in light reflected off of JR1's surface showed that the object rotates once every 5.4 hours, considered relatively quick for a KBO.

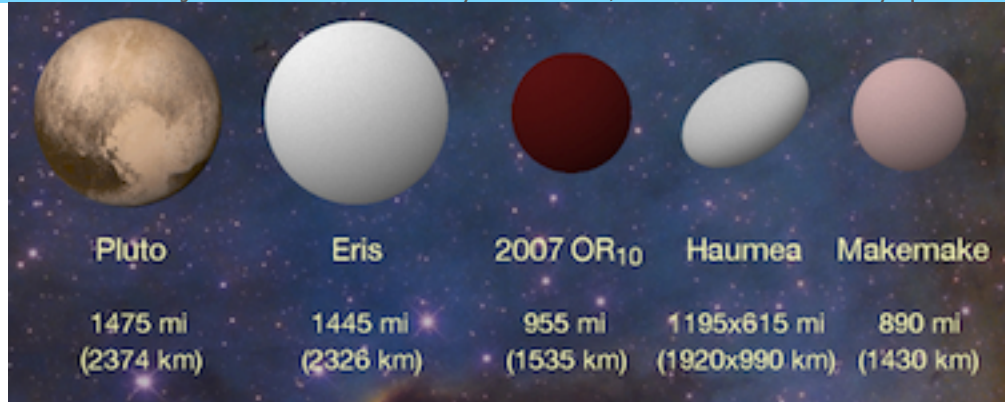

A new study identifies **2007 OR10** [in the middle, above] as the largest unnamed body in our solar system, and the third-largest dwarf planet. (Haumea has an oblong shape that is wider on its long axis than 2007 OR10, but its overall volume is smaller.) ##

**Editor:** It was the discovery of **Eris**, comparable in size to Pluto, that led to the "demotion" of Pluto from "planet" to "just another" "dwarf planet" by "dwarf astronomers" in 2006. Since then, the New Horizons probe has shown Pluto-Charon to be one of the most amazing and interesting worlds in the solar system. ##

### BEYOND PLUTO-CHARON – PLANET NINE (OR "X")

**Editor:** Astronomers are using the term **Planet 9** or **Nine**, which used to refer to Pluto, which, despite its amazing binary-planet nature, has been demoted to "dwarf planet" status. "Planet" is a Greek word meaning "wanderer" and certainly, Pluto lives up to that designation,

The term Planet X, on the other hand, can mean either "Planet 10" (X being the Roman numeral; for 10) or "Planet unknown and not yet named." Undoubtedly, once the suspected body is found, it will get a proper name taken from Greek or Roman mythology.

It was the discovery of Eris, comparable in size to Pluto, that led to the hasty "demotion" of Pluto from planet to "just another dwarf planet." PK

## Researcher links mass extinctions to 'Planet X'

30 March, 2016 - <http://phys.org/news/2016-03-links-mass-extinctions-planet.html>

Periodic mass extinctions on Earth, as indicated in the global fossil record, could be linked to a suspected ninth planet at intervals of approximately 27 million years.

Orbital anomalies seen in objects in the Kuiper Belt, a disc-shaped region of comets and other larger bodies beyond Neptune indicate the existence of a "Planet X" about 10 times the mass of Earth and currently up to 1,000 times more distant from the Sun. Three explanations had been proposed to explain the regular comet showers:

- Planet X
- A sister star to the sun
- Vertical oscillations of the sun as it orbits the galaxy.

The last two ideas have subsequently been ruled out as inconsistent with the paleontological record. Only "Planet X" remains

## Researcher links mass exWhat Might the Putative /Planet X' Look Like?

8 April, 2016 - [www.space.com/32508-what-planet-nine-looks-like-possibilities.html](http://www.space.com/32508-what-planet-nine-looks-like-possibilities.html)

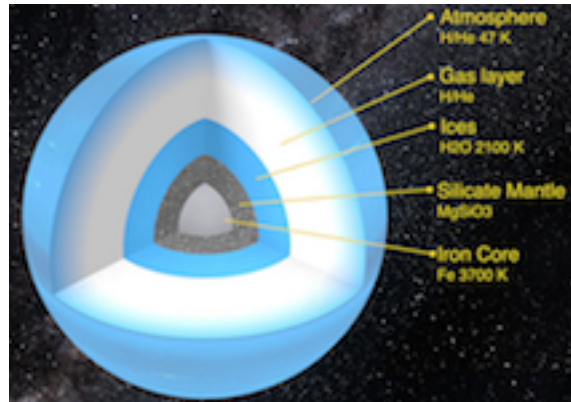

Possible internal structure of Planet Nine (or "X")

{No one has actually spotted the prospective Planet Nine; rather, they are inferring its existence based on the orbits of a half-dozen objects in the Kuiper Belt, the ring of icy bodies beyond Neptune. The assumption is that this world is a smaller version of the "ice giants" Uranus and Neptune, with an atmosphere dominated by hydrogen and helium. ##

## Researcher links mass ex'Planet X' takes shape (and distance)

8 April, 2016 - [http://www.spacedaily.com/reports/Planet\\_X\\_takes\\_shape\\_999.html](http://www.spacedaily.com/reports/Planet_X_takes_shape_999.html)

Astrophysicists at the University of Bern have modelled the evolution of the putative planet in the outer solar system. They estimate that the object has a present-day radius equal to **3.7 Earth radii (comparable to Uranus and Neptune)** and a temperature of  $-226^{\circ}\text{C}$ .

They estimate that it is 700 times further out from the Sun than Earth, compared to Neptune at 30 times further from the Sun than Earth - that is **21 times further out than Neptune**. ##

## 'Planet Nine' ('X') - A world that shouldn't exist

3 May, 2016 - <http://phys.org/news/2016-05-planet-world-shouldnt.html>

Earlier this year scientists presented evidence for Planet Nine, a Neptune-mass planet in an elliptical orbit 10 times farther from our Sun than Pluto. Since then theorists have puzzled over how this planet could end up in such a distant orbit.

New research by astronomers at the Harvard-Smithsonian Center for Astrophysics (CfA) examines a number of scenarios and finds that most of them have low probabilities. Therefore, the presence of Planet Nine remains a bit of a mystery. ##

## Where Did 'Planet Nine' ('X') Come From?

4 May, 2016 - [www.space.com/32788-planet-nine-possible-origin-explanations.html](http://www.space.com/32788-planet-nine-possible-origin-explanations.html)

Planet Nine (or "X") is perhaps 10 times as massive as Earth and orbits the Sun at an average 700 times Earth's distance from the Sun. Some astronomers are now scanning the sky in an attempt to find the supposed planet, while others are tackling another mystery: How did Planet Nine come to be?

Planet Nine may be a former exoplanet, plucked from a passing star system and captured by our solar system's gravity. Others consider the odds that Planet Nine was a formerly free-floating "rogue planet." In both cases, the odds are less than 2%.

So it's likely that Planet Nine is native to our solar system. But did it form in its present location, or begin life much closer to the sun and then get booted into the outer solar system by a gravitational interaction of some kind? Both scenarios are possible. ##

## 'Planet X' May Have Been Part Of A Cosmic Heist, If It Exists | Video

[www.space.com/33036-planet-9-may-have-been-part-of-a-cosmic-heist-if-it-exists-video.html](http://www.space.com/33036-planet-9-may-have-been-part-of-a-cosmic-heist-if-it-exists-video.html)

Astronomers at Lund University have used computer simulations of stellar and planetary movements to show how the theorized planet may have found itself in a wide orbit around the Sun. The study suggests that the planet could have been 'stolen' from a nearby system about 4.5 billion years ago.

'Planet X' Is Still Just a Theory, NASA Cautions. ##

31 May, 2016 – [www.spacedaily.com/reports/Theft\\_behind\\_Planet\\_9\\_in\\_our\\_solar\\_system\\_999.html](http://www.spacedaily.com/reports/Theft_behind_Planet_9_in_our_solar_system_999.html)

There is a lot to indicate that Planet 9 was captured by the young sun and has been a part of our solar system completely undetected ever since.

"It is almost ironic that while astronomers often find exoplanets hundreds of light years away in other solar systems, there's probably one hiding in our own backyard"

Stars are born in clusters and often pass by one another. It is during these encounters that a star can "steal" one or more planets in orbit around another star. This is probably what happened when our own sun captured Planet 9." ##

1 June, 2016 – [www.space.com/33041-planet-nine-captured-exoplanet.html](http://www.space.com/33041-planet-nine-captured-exoplanet.html)

"It is almost ironic that while astronomers often find exoplanets hundreds of light-years away in other solar systems, there's probably one hiding in our own backyard." ##

## Pointing to Planet X

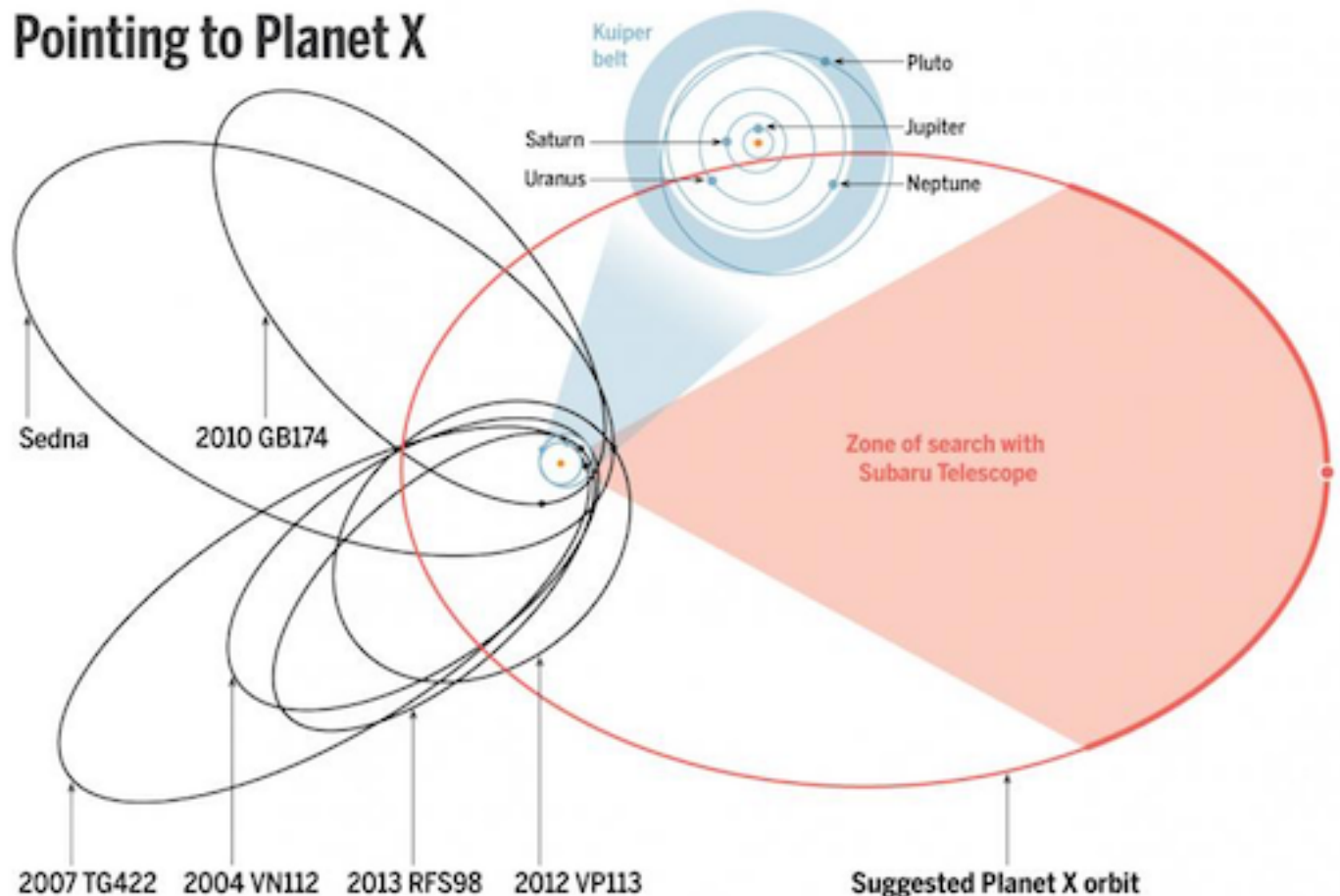

[http://www.sciencemag.org/sites/default/files/styles/inline\\_colwidth\\_4\\_3/public/images/Orbits\\_1280\\_PlanetX2.jpg?itok=1wE6ahIP&timestamp=1453231167](http://www.sciencemag.org/sites/default/files/styles/inline_colwidth_4_3/public/images/Orbits_1280_PlanetX2.jpg?itok=1wE6ahIP&timestamp=1453231167)

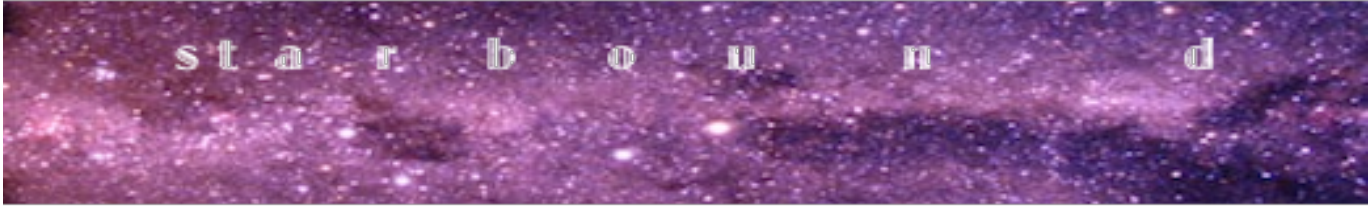

## EARTH-BOUND TELESCOPES

### Light Pollution Ruins Night-Sky Views for One-Third of Humanity

10 June, 2016 - [www.space.com/33138-light-pollution-world-sky-atlas.html](http://www.space.com/33138-light-pollution-world-sky-atlas.html)

<http://www.space.com/33138-light-pollution-world-sky-atlas.html>

<http://phys.org/news/2016-06-milky-hidden-one-third-humanity.html>

<http://www.space.com/33131-milky-way-not-visible-for-billions-of-humans-light-pollution-atlas-visualization.html>

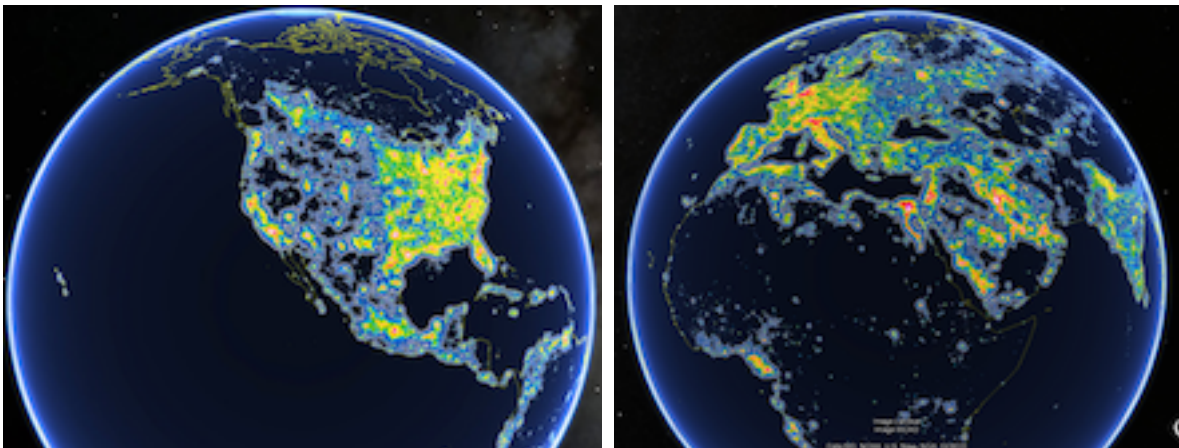

A new, comprehensive atlas of worldwide light pollution reveals that one-third of all people cannot see the Milky Way in the sky, including nearly 80 percent of North Americans.

## SPACE TELESCOPES

### Kepler Planet-Hunting Spacecraft in 'Emergency Mode'

10 April, 2016 - [www.space.com/32529-nasa-kepler-exoplanet-spacecraft-emergency-mode.html](http://www.space.com/32529-nasa-kepler-exoplanet-spacecraft-emergency-mode.html)

**NASA's prolific Kepler planet-hunting spacecraft appears to be in trouble.** Its handlers learned during a routine contact on April 7<sup>th</sup>, that the space telescope — which has discovered more than 1,000 alien planets since its March 2009 launch — is now in "emergency mode" (EM) — the lowest operational mode and is fuel intensive.

The last regular contact with Kepler occurred on April 4, and the spacecraft was healthy and operating properly at that time,

Recovering from EM is the team's priority at this time. The spacecraft emergency provides priority access to ground-based communications at the agency's Deep Space Network.

It could take some time to diagnose and fix the problem, because Kepler orbits the sun rather than Earth, and there is thus a significant time delay in communications. At the moment, it takes 13 minutes for a signal to travel the nearly 75 million miles (121 million kilometers) from mission control to Kepler and back again, ##

## Planet-Hunting Kepler Spacecraft Back in Action After Glitch

22 April, 2016 – [www.space.com/32679-nasa-kepler-spacecraft-glitch-recovery.html](http://www.space.com/32679-nasa-kepler-spacecraft-glitch-recovery.html)

The space telescope, which has discovered about half of all known alien planets to date — returned to duty on April 19. The spacecraft is now ready to start its new gravitational microlensing campaign, known as Campaign 9 or C9. ##

## Kepler Telescope Finds Largest Collection of Exo-Planets Yet – 1284

[www.nasa.gov/press-release/nasas-kepler-mission-announces-largest-collection-of-planets-ever-discovered](http://www.nasa.gov/press-release/nasas-kepler-mission-announces-largest-collection-of-planets-ever-discovered)

10 May, 2016 – [www.space.com/32847-nasa-kepler-1284-exoplanets-find-in-pictures.html](http://www.space.com/32847-nasa-kepler-1284-exoplanets-find-in-pictures.html)

This announcement more than doubles the number of confirmed planets from Kepler.

"Before the Kepler space telescope launched, we did not know whether exoplanets were rare or common in the galaxy. Thanks to Kepler and the research community, we now know there could be more planets than stars. This knowledge informs the future missions that are needed to take us ever-closer to finding out whether we are alone in the universe." ##

## Colors Of Alien Life May Be Key To Finding Them | Video

[www.space.com/32889-colors-of-alien-life-may-be-key-to-finding-them-video.html](http://www.space.com/32889-colors-of-alien-life-may-be-key-to-finding-them-video.html)

( Original 2015 article: [www.space.com/28906-alien-life-earth-microbe-catalog.html](http://www.space.com/28906-alien-life-earth-microbe-catalog.html) )

Astrophysicist Lisa Kaltenegger (professor of astronomy and director of the Carl Sagan Institute) explains how searching for biosignatures on other planets can be done by observing colors that dominate their landscapes.

## NASA Extends Hubble Space Telescope Science Operations Contract

23 June, 2016 –

[/www.nasa.gov/press-release/nasa-extends-hubble-space-telescope-science-operations-contract](http://www.nasa.gov/press-release/nasa-extends-hubble-space-telescope-science-operations-contract)

This action will extend the period of performance from July 1 through June 30, 2021. The contract value will increase by approximately \$196.3 million for a total contract value of \$2.03 billion. ##

## OUR CLOSEST STAR: THE SUN

### Ground-breaking images of nearby star give new insight into Sun's infancy

4 May, 2016 – <http://phys.org/news/2016-05-ground-breaking-images-nearby-star-insight.html>

A team of international astronomers, have used cutting-edge techniques to create the first direct image of surface structures on the star **Zeta Andromedae** – found 181 light years from Earth.

In order to image the star's surface during one of its 18-day rotations, researchers used a method called interferometry, where the light of physically separate telescopes is combined in order to create the resolving power of a 330m telescope.

They discovered the star, showed signs of 'starspots' – the equivalent of sunspots on our Sun, but the pattern of these spots differs significantly. These results challenge current understandings of how magnetic fields of stars influence their evolution.

These findings offer a rare glimpse of how the Sun behaved in its infancy, while the solar system was first forming. ##

## Superflares from the Sun May Have Sparked Life by Warming Earth

23 May, 2016 – [www.space.com/32956-sun-superflares-life-on-earth.html](http://www.space.com/32956-sun-superflares-life-on-earth.html)

Life on Earth may owe its existence to incredibly powerful storms that erupted on the sun long ago. Potent and frequent solar eruptions could have warmed the early Earth enough for life to take root, and also provided the vital energy needed to transform simple molecules into the complex building blocks of life, such as DNA. ##

## Young Star Offers a Glimpse of the Sun's Past

[www.esa.int/spaceinimages/Images/2016/06/Young\\_star\\_offers\\_a\\_glimpse\\_of\\_the\\_Sun\\_s\\_past](http://www.esa.int/spaceinimages/Images/2016/06/Young_star_offers_a_glimpse_of_the_Sun_s_past)

**13 June, 2016** – Located 1800 light-years away in the constellation Cygnus, V1331 Cyg may look like a star, it may be called a star, but it does not yet generate energy like a normal star. This is because this star is still being formed.



The image was taken by the NASA Hubble Space Telescope and is a combination of three exposures taken at different wavelengths. These almost correspond to human eyesight: blue, green and, instead of red light that our eyes would see, Hubble used near-infrared.

It offers a fascinating glimpse into our own past because our Sun began its life as such a 'T Tauri' star some 4.6 billion years ago. Originally nothing but a diffuse cloud of gas in space. Slowly over time, gravity has pulled it together, but the process is not yet over. V1331 is not yet fully formed and so is still larger than it will eventually be once gravity has done its job. It is shining because of the energy being released as it shrinks.

Eventually, it will be compact enough that the temperature in its centre will ignite nuclear fusion. Hydrogen will then be transformed into helium and this will release the torrents of energy that will make V1331 Cyg shine for billions of years as a bona fide star. ##

## SEARCH FOR EXO-PLANETS & LIFE

### Extreme-weather planet raise questions about hot Jupiters' origins

28 March, 2016 – <http://phys.org/news/2016-03-extreme-weather-planet-hot-jupiters.html>

For centuries, the solar system was viewed as a standard blueprint for planetary systems in the universe, with a star (sun) at the center of a circular track, and a planet orbiting within each lane. Smaller, rockier planets in the interior lanes, larger gas giants further out.

But over the last 20 years, more powerful telescopes have revealed a host of exotic systems with completely unexpected configurations. Now an even weirder planetary system may render the puzzle more challenging. Using NASA's Spitzer Space Telescope, scientists have observed an exoplanet, HD 80606 b, about the size of Jupiter, though four times as massive.

HD 80606 b spends about 100 days of its year traveling an oblong route away from and then returning toward its star, much like the trajectory of a comet. Then, in a matter of just 20 hours, it sweeps around the star, very nearly touching it, before swinging away again. At closest approach, the planet receives an enormous amount of energy from its star—over a thousand times the energy the Earth receives from the sun each day. ##

### Search for alien signals expands to 20,000 star systems

30 March, 2016 – <http://phys.org/news/2016-03-alien-star.html>

The search for radio signals from alien worlds is expanding to 20,000 star systems that were previously considered poor targets for intelligent extraterrestrial life. New scientific data has led the SETI Institute to believe systems orbiting red dwarf – dim, long-lived stars that are on average billions of

Past TTSIQ issues are online at: [www.moonsociety.org/international/ttsiq/](http://www.moonsociety.org/international/ttsiq/) and at: [www.nss.org/tothestars/](http://www.nss.org/tothestars/)



years older than our sun—are worth investigating. The reasoning? "Older solar systems have had more time to produce intelligent species."

The two-year project involves picking from a list of about 70,000 red dwarfs and scanning 20,000 of the nearest ones, along with the cosmic bodies that circle them.

Scientists will use the SETI Institute's Allen Telescope Array in northern California, a group of 42 antennas that can observe three stars simultaneously. ##

## Oasis in “the brown dwarf desert” surprises and relieves astronomers

<http://phys.org/news/2016-03-oasis-brown-dwarf-desert-astronomers-relieved.html>

31 March, 2016 – Although astronomers have found plenty of brown dwarfs floating through space on their own, they found very few as stellar companions. Even in recent years, as new and sensitive detection techniques have allowed them to discover thousands of extrasolar planets, brown dwarfs have remained elusive – in spite of the fact that they should be easier to find than planets.

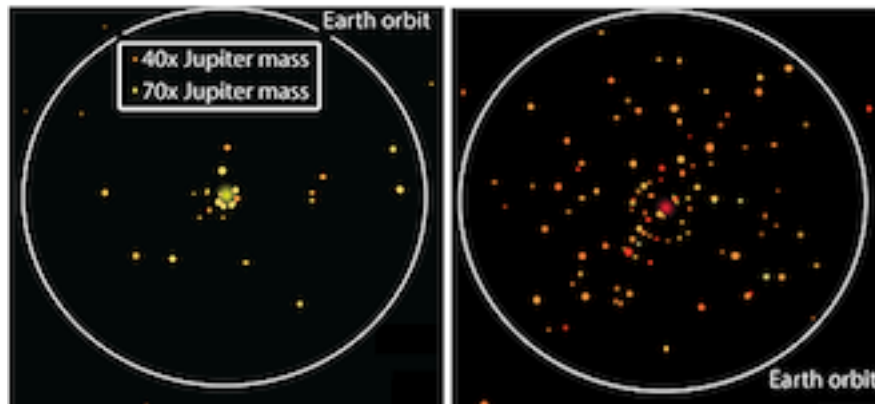

**Left:** previous census of nearby Brown Dwarfs    **Right:** New Census

The “before” and “after” comparison of the number of known brown dwarfs orbiting other stars. For each of the 41 close-in brown dwarf companions detected previously.

- The **left** panel shows the distance to its host star.
- The **right** panel shows the 112 brown dwarfs discovered in the new study.

In both panels, the sizes of the brown dwarfs indicate their masses, and the circle shows the distance to Earth’s orbit.

## Laser cloaking device could help us hide from aliens

31 March, 2016 – <http://phys.org/news/2016-03-laser-cloaking-device-aliens.html>

<http://phys.org/news/2016-04-earth.html>

“The fate of humanity if aliens were to discover Earth with its balmy climate and bountiful resources, has long been a concern for scientists—many of whom fear the worst.”

*[Editor: this fear presupposes that civilizations are √ numerous enough, √ sufficiently contemporary and √ close enough together to encourage “interstellar imperialism” - hogwash!! ##*

## L1551 IRS 5: A curious case of a young and active binary star

31 March, 2016 – <http://phys.org/news/2016-03-l1551-irs-curious-case-young.html>

L1551 IRS 5 is a young binary star, only about half a million years old. Due to its proximity (about 450 light years away) and its high activity, the system has been intriguing astronomers for many years.

The pair is located at the edge of a dense molecular cloud L1551 and has an atomic jet and an aligned molecular outflow that displays well separated blue- and red-shifted outflow lobes. Both stars are surrounded by a dust and gas disk that could be forming planetesimals.

The larger of the pair is going to be something like the sun when it gets older, while the secondary is much smaller and will be a so-called red dwarf star. They are entering the very active T-Tauri star phase with jets and gas outflows. ##

Past TTSIQ issues are online at: [www.moonsociety.org/international/ttsiq/](http://www.moonsociety.org/international/ttsiq/) and at: [www.nss.org/tothestars/](http://www.nss.org/tothestars/)

## Beyond Tatooine! – first triple-sun planetary system found

1 April, 2016 – <http://phys.org/news/2016-04-planet-triple-star.html>

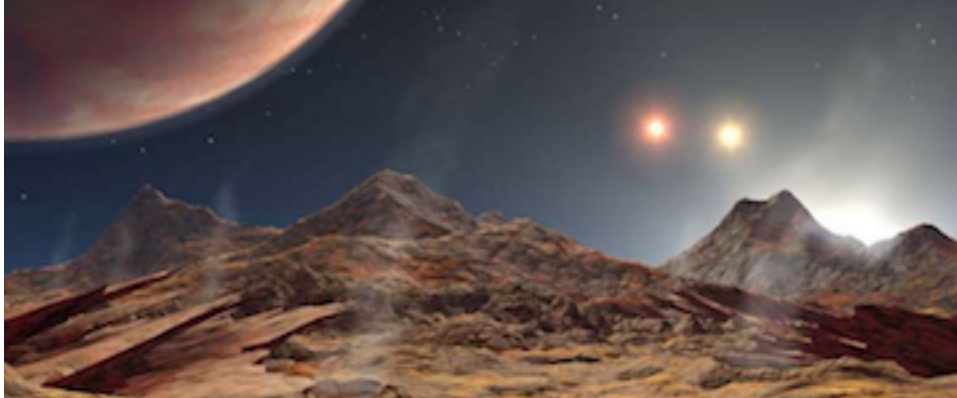

Artist's concept of HD 1885 Ab, the first known planet in a triple-star system

A team of researchers working at the Harvard-Smithsonian Center for Astrophysics has announced the finding of a triple-star system—one that also has a stable orbit planet in it.

Known planets with three stars appearing in their sky are rare, this new discovery is just the fourth, and the closest one yet, allowing for a better look than has been possible with the other finds. The main star is also brighter than the other stars that serve as suns for their planets, making it easier to study both the star and the planet. ##

## Jupiter-size planet largest yet found orbiting 2 stars “Tatooine-style”

[www.space.com/33154-jupiter-sized-planet-is-largest-found-yet-orbiting-two-stars-video.html](http://www.space.com/33154-jupiter-sized-planet-is-largest-found-yet-orbiting-two-stars-video.html)

The planet Kepler-1647b has been confirmed with Kepler Space Telescope transit observation and advanced computer programs. It is 3,700 light-years from Earth and is estimated to be 4.4 billion years old. – watch VIDEO

## Finding other Earths—the chemistry of star and planet formation

1 April, 2016 – <http://phys.org/news/2016-04-earththe-chemistry-star-planet-formation.html>

Recent studies of star and planet-formation have shown that chemistry plays a pivotal role in both shaping these systems and delivering water and organic species to the surfaces of nascent terrestrial planets.

Using the Earth and our solar system as the basis for their data, scientists explored the relative disposition of carbon and nitrogen in each stage of star and planet formation to learn more about core formation and atmospheric escape.

Analyzing the carbon-silicon atomic ratio in planets and comets, we learned that rocky bodies in our solar system are generally carbon-poor. As carbon is essential for our survival, we need to determine the range of carbon content that terrestrial planets can have and still have active biosystem. ##

## Scorching Jupiter-Like Planet Throws Wrench in Planet Migration Ideas

7 April, 2016 – [www.space.com/32491-hot-jupiter-defies-formation-theory.html](http://www.space.com/32491-hot-jupiter-defies-formation-theory.html)

"Hot Jupiters" — massive planets that orbit very close to their parent stars — have been found to be abundant outside Earth's solar system. But how did these gas-giant planets in other solar systems get so close to their parent stars?

The Spitzer Space Telescope studied HD 80606b, a Jupiter-size planet that gets so close to its parent star that it burns at 2,000°F (1,100°C) on the sunlit side. Observations of the 111-day orbit suggest that the planet is spiraling into its parent star very slowly.

## Discover rare brown dwarf, essential for testing theoretical models

8 April, 2016 – <http://phys.org/news/2016-04-physicists-rare-brown-dwarf-essential.html>

Brown dwarfs are objects that have initially begun the process of forming a star but somehow did not accumulate enough mass and core pressure to ignite nuclear fusion—the process by which “stars” – including our Sun, releases energy in the form of light.

**HD 4747 B** is a rare brown dwarf. As a new mass, age and metallicity benchmark, HD 4747 B will serve as a laboratory for precision astrophysics to test theoretical models. ##

**Editor:** While Brown Dwarfs are not bright enough to host “Earthlike” planets, they could conceivably host “Europa-like” “moons” with as much chance of hosting life in their ice-crust covered oceans as might be the case with Jupiter’s moon, Europa. - “**Europids**” - PK

**Related** 4/8/2016 – <http://phys.org/news/2016-04-young-unattached-jupiter-analog-solar.html>

## Giant Free-Flying Exoplanet One of Closest 'Rogue' Worlds Yet Seen

8 April, 2016 – [www.space.com/32499-nearby-rogue-alien-planet.html](http://www.space.com/32499-nearby-rogue-alien-planet.html)

A huge, newly discovered alien planet that zooms through space without a parent star is one of the closest such “rogue” worlds to Earth yet seen, Planet 2MASS J1119-1137 belongs in the youngest group of stars in the solar neighborhood, known as the TW Hydrae association, which contains about two dozen 10 million-year-old stars, all moving together through space.

A huge, newly discovered alien planet that zooms through space without a parent star is one of the closest such “rogue” worlds to Earth yet seen. Known as 2MASS J1119-1137, It is four to eight times more massive than Jupiter and lies about 95 light-years from Earth. ##

## Kepler's New Mission: To Hunt Strange Orphan Worlds

[www.space.com/32523-keplers-new-mission-to-hunt-strange-orphan-worlds.html](http://www.space.com/32523-keplers-new-mission-to-hunt-strange-orphan-worlds.html)

8 April, 2016 = The **Kepler Space Telescope** this week begins a search for free-flying planets to learn just how common orphan worlds may be.

Planets without host stars are difficult to find, but they do exist. Scientists believe these bodies were ejected from their solar system families due to gravitational dynamics, lured away by tidal forces from interloping passersby, or perhaps even formed without the benefit of a parent star. What they don't know is if orphan planets are common or not. ##

## Searching for Far Out and Wandering Worlds

8 April, 2016 – [www.spacedaily.com/reports/Searching\\_for\\_Far\\_Out\\_and\\_Wandering\\_Worlds\\_999.html](http://www.spacedaily.com/reports/Searching_for_Far_Out_and_Wandering_Worlds_999.html)

Over the past 20 years more than 5,000 exoplanets have been detected beyond our solar system, the majority of which are snuggled up to their host star completing an orbit (or year) in hours, days or weeks, while some have been found orbiting as far as Earth is to the Sun, taking one Earth year to circle.

But, what about those worlds that orbit much farther out, such as Jupiter and Saturn, or, in some cases, **free-floating exoplanets that are on their own and have no star to call home?** Some studies suggest that there may be more free-floating exoplanets than stars in our galaxy.

Their tool? “**microlensing**” – the deflecting or warping the direction of light that passes close to massive objects. The effect is to make gravity act as a lens, concentrating light from a distant object ##

## NASA invests in technology to detect exo planets

[www.spacedaily.com/reports/NASA\\_Invests\\_in\\_Two\\_Dimensional\\_Spacecraft\\_Reprogrammable\\_Microorganisms\\_999.html](http://www.spacedaily.com/reports/NASA_Invests_in_Two_Dimensional_Spacecraft_Reprogrammable_Microorganisms_999.html)

12 April, 2016 – Among 13 proposals through NASA Innovative Advanced Concepts (NIAC), a program that invests in transformative architectures through the development of pioneering technologies, is a method of computational imaging that leverages extrasolar intensity fluctuations to detect “echoes” from planets and other structures orbiting a distant star. ##

## New tool refines exoplanet search

12 April, 2016 – [www.spacedaily.com/reports/New\\_tool\\_refines\\_exoplanet\\_search\\_999.html](http://www.spacedaily.com/reports/New_tool_refines_exoplanet_search_999.html)

One of the most-popular and successful techniques for finding and confirming planets is called the radial velocity method. This technique takes advantage of the fact that the planet's gravity also affects the star in return. As a result, astronomers are able to detect the tiny wobbles the planet induces as its gravity tugs on the star. Using this method, astronomers have detected hundreds of exoplanets.

For certain kinds of low-mass stars, however, there are limitations to the standard radial velocity method that can cause false positives – in other words, find something that looks like a planet, but isn't.

With a new radial velocity technique, they examined a different, longer wavelength of light. Switching from the visible spectrum to the near-infrared, the wobble effect caused by an orbiting planet will remain the same regardless of wavelength,

But looking in the near-infrared will allow astronomers to reject false positives caused by sunspots and other phenomena that will not look the same in near-infrared as they do in visible light,##

## 100 Years Ago an (“ex”) Exoplanet was Unknowingly Discovered

[www.space.com/32562-100-years-ago-an-exoplanet-was-unknowingly-discovered.html](http://www.space.com/32562-100-years-ago-an-exoplanet-was-unknowingly-discovered.html)

14 April, 2013 – Long before the first confirmed finds of planets around other stars in the 1990s, an observer in 1917 caught **evidence of planetary debris** around a new star. The evidence came from an astronomical glass plate from the Carnegie Observatories' Collection that observed a white dwarf, the core of a star like our sun that has since died and shed its gassy layers.

**Van Maanen 2 (van Maanen's Star)** is a white dwarf, a dense, compact remnant of a star that is no longer generating energy, having about 68% of the Sun's mass but only 1% of the Sun's radius.<sup>[6]</sup> Out of the white dwarfs known, it is the third closest to the Sun, after Sirius B and Procyon B, and the closest known solitary white dwarf. – [https://en.wikipedia.org/wiki/Van\\_Maanen\\_2](https://en.wikipedia.org/wiki/Van_Maanen_2)

The spectrum recorded the chemical fingerprint of the star, known as **van Maanen's star**, and showed heavier elements that should not have been there. The presence of calcium, magnesium and iron should have vanished into the star due to their weight.

These elements show that there is a lot of debris in this planetary system that is continuously falling into the star, creating what is known as a "polluted white dwarf." They have only been known for about the last 12 years. It was an initial surprise to astronomers because white dwarfs, being so old, were not expected to have any leftover planetary material (which is common in young star systems. –

**Van Maanen 2 (van Maanen's Star)** is a white dwarf, a dense, compact remnant of a star that is no longer generating energy, having about 68% of the Sun's mass but only 1% of the Sun's radius.<sup>[6]</sup> Out of the white dwarfs known, it is the third closest to the Sun, after Sirius B and Procyon B, and the closest known solitary white dwarf. – [https://en.wikipedia.org/wiki/Van\\_Maanen\\_2](https://en.wikipedia.org/wiki/Van_Maanen_2)

Van Maanen's Star is in the Constellation Pisces and is about 13.9 light years distant.

## Beyond Earth Day: Where Will Alien Life Be Discovered First?

21 April, 2016 – [www.space.com/32642-alien-life-thinkgeek-earth-day-poll.html](http://www.space.com/32642-alien-life-thinkgeek-earth-day-poll.html)

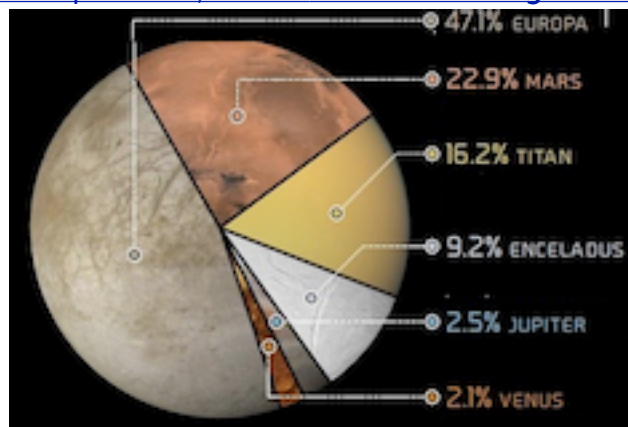

ThinkGeek.com asked readers where in the solar system alien life might be found.

The results were pretty interesting.

**Poll results:** Europa? 47% – Mars? 23% – Titan? 16% – Enceladus? 9% – Jupiter? 3% – Venus? 2%

**Editor's take:** While I believe that life forms are more likely to exist on Europa than on Mars, NASA's reluctance to consider landed missions on Europa (to examine the rust colored material in the moon's myriad cracks (upwelling of ocean material) makes it more likely that we'll find life on Mars first. ##

## These 3 Alien Planets Around a Tiny, Cold Star Just Might Support Life

[www.space.com/32761-three-alien-planets-trappist-1-star-could-support-life.html](http://www.space.com/32761-three-alien-planets-trappist-1-star-could-support-life.html)

[www.space.com/32754-three-nearby-alien-planets-could-host-life-only-40-light-years-away-video.html](http://www.space.com/32754-three-nearby-alien-planets-could-host-life-only-40-light-years-away-video.html)

[www.space.com/32760-three-possibly-habitable-planets-orbit-close-to-their-star-video.html](http://www.space.com/32760-three-possibly-habitable-planets-orbit-close-to-their-star-video.html)

<http://phys.org/news/2016-05-years-earth-planets-host-life.html>

2 May, 2016 - Three potentially habitable Earth-size planets have been discovered orbiting a dim, cold nearby star that is barely larger than Jupiter.

"These kinds of tiny, cold stars may be the places we should first look for life elsewhere in the universe, because they may be **the only places where we can detect life on distant Earth-sized planets with our current technology.**"

The star was discovered using TRAPPIST (TRANSiting Planets and Planetesimals Small Telescope), a telescope in Chile. Now known as **TRAPPIST-1**, it is located in the constellation of Aquarius about **39 light-years from Earth.**

TRAPPIST-1 is 2,000 times less bright than the Sun, and a bit less than half as warm, about 1/12th the Sun's mass, and less than one-eighth its width, making it only slightly larger in diameter than Jupiter. This type of star, an "**ultracool dwarf,**" makes up about 15% of the stars near the Sun.

Scientists spotted the three planets by observing TRAPPIST-1 dimming at regular intervals as the worlds crossed in front of it. These exoplanets are the first found around an ultracool dwarf.

The three planets are each only about 10% larger in diameter than Earth. The two innermost planets are about 60 to 90 times closer to their star than the Earth to the Sun, with orbits only 1.5 and 2.4 days long, respectively. The orbit of the 3rd planet ranges between 4.5 and 73 days long. The small size of the star and its planets' orbits means "the structure of this planetary system is much more similar in scale to the system of Jupiter's moons than to that of the solar system, ##

## Are we alone? Setting some limits to our uniqueness

28 April, 2016 - <http://phys.org/news/2016-04-limits-uniqueness.html>

11 May, 2016 - [www.space.com/32711-searching-for-alien-life-are-we-alone.html](http://www.space.com/32711-searching-for-alien-life-are-we-alone.html)

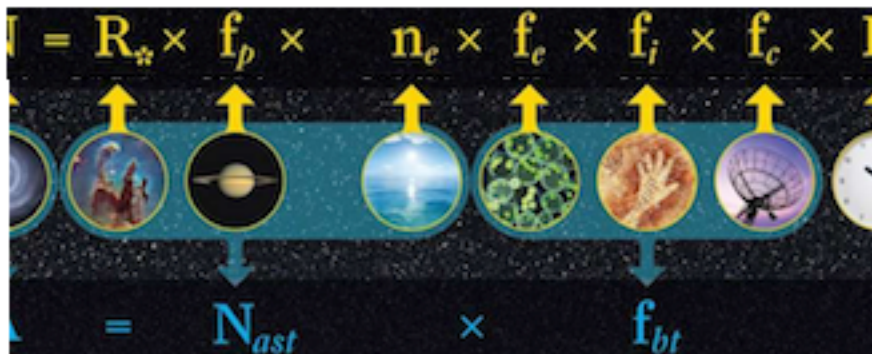

In 1961, astrophysicist Frank Drake developed an equation to estimate the number of advanced civilizations likely to exist in the Milky Way galaxy. The Drake equation (top row) has been a durable framework for research, and space technology has advanced scientists' knowledge of several variables.

But it is impossible to do anything more than guess at variables such as L, the probably longevity of other advanced civilizations. In new research/

Adam Frank and Woodruff Sullivan offer a new equation (bottom row) to address a slightly different question: What is the number of advanced civilizations likely to have developed over the history of the observable universe? ##

## A Cautionary Tale From Planet Earth

6 May, 2016 – [www.spacedaily.com/reports/A\\_Cautionary\\_Tale\\_From\\_Planet\\_Earth\\_999.html](http://www.spacedaily.com/reports/A_Cautionary_Tale_From_Planet_Earth_999.html)

The new IMAX Movie "Beyond Earth, A Beautiful Planet" offers a fascinating look at what life could be like if conditions were right on distant planets light years away. The film refers to what scientists call the "Goldilocks Zone" – a system not too hot, nor too cold for liquid water to exist. Myers singles out one system called Kepler-186, which contains five Earth-sized planets, one of which – Kepler-186f – is situated at the right distance away from its star to sustain water ... and life?

Our world is changing: rising ocean levels, deforestation, urban spreading, and other evidence easily seen from orbit. ##

## 1st Alien Earth Still Elusive Despite Huge Exoplanet Haul

11 May, 2016 – [www.space.com/32852-alien-earth-search-nasa-kepler-space-telescope.html](http://www.space.com/32852-alien-earth-search-nasa-kepler-space-telescope.html)

The first "alien Earth" continues to evade detection. On May 10, 2016, astronomers announced the discovery of 1,284 exoplanets by NASA's Kepler space telescope, bringing the prolific observatory's total haul to 2,325 confirmed alien worlds. But none of these appears to be a true Earth twin. ##

## Surprise! 4 Alien Worlds Locked in Fragile Dance for 6 Billion Years

12 May, 2016 – [www.space.com/32860-four-alien-planets-resonance-kepler-223.html](http://www.space.com/32860-four-alien-planets-resonance-kepler-223.html)

Four alien worlds have somehow managed to remain locked in a delicate orbital embrace for more than 6 billion years.

The four known exoplanets in the Kepler-223 system, which lies about 4,450 light-years from Earth, are in resonance, meaning their orbital periods are related to each other by a ratio of two small integers.

The two innermost worlds, Kepler-223b and Kepler-223c, are in a 4:3 resonance: Kepler-223b completes four laps around the host star in the time it takes Kepler-223c to orbit three times.

The two middle planets (Kepler-223c and Kepler-223d) are in a 3:2 resonance, whereas the two outermost worlds (Kepler-223d and Kepler-223e) are in a 4:3 resonance. ##

**Editor:** Wouldn't it be nice if we could move Venus and Mars into similar resonance orbits with Earth, in both cases bringing them nearer, cooling Venus a tad (273 day orbit vs. Present 225) and warming Mars quite a bit (487 day orbit vs. Present 687)? Unfortunately, such feats are likely to remain in the realm of science fiction for well beyond our time. ##

## Alien Megastructure? Dimming Star May Have Less Exotic Explanation

12 May, 2016 – [www.space.com/32864-alien-megastructure-star-telescope-changes.html](http://www.space.com/32864-alien-megastructure-star-telescope-changes.html)

Last fall, a star named KIC 8462852 made news when scientists found **unusual fluctuations** in the object's light. The star is an otherwise-ordinary F-type star, slightly larger and hotter than our Sun; it is about 1,480 light-years away from Earth in the constellation Cygnus.

But astronomers from Yale University in Connecticut, along with citizen scientists from the Planet Hunters crowdsourcing program, found something odd: dozens of strange instances of the star darkening over a 100-day period when they analyzed data from NASA's Kepler Space Telescope.

The dimming that apparently occurred over the course of a century may actually have resulted from how telescopes and cameras have changed over time. ##

## Kepler-62f: A Possible Water World

13 May, 2016 – <http://www.space.com/24142-kepler-62f.html>

Kepler-62f is potentially an Earth-like planet about 1,200 light-years from our planet. The world is only 1.4 times bigger\* than Earth and is in orbit around a star that is somewhat dimmer and smaller than the sun. It orbits in what is believed to be the habitable region of its star (the “Goldilocks zone” in which surface water would remain liquid).

A modeling study of Kepler-62f suggested that the planet would likely be engulfed in water.

• **Editor:** if this is the diameter, its mass, assuming a density similar to Earth's, would be 2.75 times Earth's, and its gravity pretty uncomfortable.

## Dying Stars May Transform Frozen Worlds Into Havens for Life

16 May, 2016 – [www.space.com/32888-dying-stars-make-habitable-exoplanets.html](http://www.space.com/32888-dying-stars-make-habitable-exoplanets.html)

When most stars reach old age and begin to run out fuel, they swell up to hundreds of times their normal size, engulfing planets that orbit too close. But can planets that escape this fiery demise still support life? In this state, can planets around the dying star host life? New research says yes.

In about 7.5 billion years, the sun will have begun its march to the grave and will start expanding. Eventually it will swell to about 200 times its current size. It will swallow Mercury and Venus, and make Earth uninhabitable. But currently frigid locations in the solar system, like the icy moons of Saturn and Jupiter, might become just the right temperature for life.

Many stars in the universe become red giants, and some can remain that way for billions of years. The new work provides an in-depth look at how long planets can remain habitable around red giant stars — in some cases, for up to 9 billion years, which is twice Earth's current age. That's sufficiently long for life to form from scratch, or to flourish in a newer, more welcoming environment. ##

## Kepler-223 System Offers Clues to Planetary Migration

[www.spacedaily.com/reports/Kepler\\_223\\_System\\_Offers\\_Clues\\_to\\_Planetary\\_Migration\\_999.html](http://www.spacedaily.com/reports/Kepler_223_System_Offers_Clues_to_Planetary_Migration_999.html)

20 May, 2016 – The four planets of the Kepler-223 star system appeared to have little in common with the planets of our own solar system today. But a new study using data from NASA's Kepler space telescope suggests a possible commonality in the distant past. The Kepler-223 planets orbit their star in the same configuration that Jupiter, Saturn, Uranus and Neptune may have had in the early history of our solar system, before migrating to their current locations.

"Exactly how and where planets form is an outstanding question in planetary science. "Our work essentially tests a model for planet formation for a type of planet we don't have in our solar system."

The puffy, gaseous planets orbiting Kepler-223, all of which are far more massive than Earth, orbit close to their star. "That's why there's a big debate about how they formed, how they got there and why don't we have an analogous planet in our solar system," ##

## Many Earth-Like Alien Planets Likely Too Hot for Life

25 May, 2016 – [www.space.com/32993-earth-like-exoplanets-too-hot-life.html](http://www.space.com/32993-earth-like-exoplanets-too-hot-life.html)

There may be far fewer potentially life-supporting alien planets out there than scientists had thought. Many Earth-like exoplanets that orbit red dwarf stars in the "habitable zone" — the range of distances at which it's thought that liquid water can exist — are actually too hot to host life, a new study suggests. ##

## Universe's first life might have been born on carbon planets

7 June, 2016 – <http://phys.org/news/2016-06-universe-life-born-carbon-planets.html>

Our Earth consists of silicate rocks and an iron core with a thin veneer of water and life. But the first potentially habitable worlds to form might have been very different. New research suggests that planet formation in the early universe might have created carbon planets consisting of graphite, carbides, and diamond. Astronomers might find these diamond worlds by searching a rare class of stars.

This work shows that even stars with a tiny fraction of the carbon in our solar system can host planets and that there is "good reason to believe that alien life will be carbon-based, like life on Earth, so this also bodes well for the possibility of life in the early universe. ##

## Newborn Alien World Is Getting Annihilated by Its Host Star

10 June, 2016 - [www.space.com/33142-newborn-exoplanet-destroyed-by-parent-star.html](http://www.space.com/33142-newborn-exoplanet-destroyed-by-parent-star.html)  
[www.spacedaily.com/reports/Likely\\_new\\_planet\\_may\\_be\\_in\\_slow\\_death\\_spiral\\_999.html](http://www.spacedaily.com/reports/Likely_new_planet_may_be_in_slow_death_spiral_999.html)

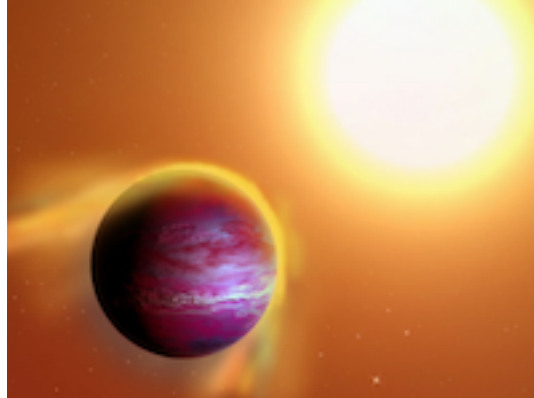

Artist's illustration of the giant planet candidate PTF08-8695b, orbiting a 2-million-year-old star in the constellation Orion every 11 hours. The newborn star's gravity appears to be pulling away the outer layers of the Jupiter-like world. ##

## Alien life on most exoplanets likely dies young

6 June, 2016 - <http://phys.org/news/2016-06-alien-life-exoplanets-dies-young.html>

Astronomers have found a plethora of planets around nearby stars. And it appears that Earth-sized planets in habitable zones are probably common. Many scientists and commentators equate "more planets" with "more E.T.s". However, the violence and instability of the early formation and evolution of rocky planets suggests that most aliens will be extinct fossil microbes. ##

## Cloudy days on exoplanets may hide atmospheric water

8 June, 2016 - <http://phys.org/news/2016-06-cloudy-days-exoplanets-atmospheric.html>

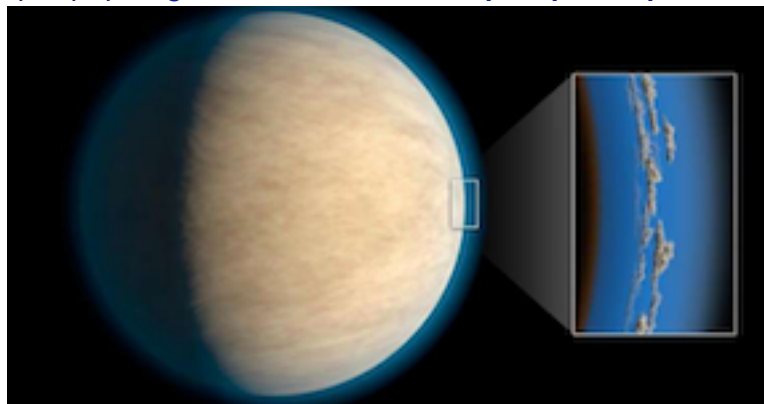

Hot Jupiters, exoplanets around the same size as Jupiter that orbit very closely to their stars, often have cloud or haze layers in their atmospheres, while their surface temperatures could be as high as 1100°C (2,000 °F) water vapor clouds are possible. Researchers focused on a collection of hot Jupiters studied by NASA's Hubble Space Telescope. They found that the atmospheres of about half of the planets were blocked by clouds or haze. ##

## Methyl Alcohol Detected In Planet-Forming Disk For First Time | Video

[www.space.com/33169-methyl-alcohol-detected-in-planet-forming-disk-for-first-time-video.html](http://www.space.com/33169-methyl-alcohol-detected-in-planet-forming-disk-for-first-time-video.html)

Astronomers using the Atacama Large Millimeter/Submillimeter Array (ALMA) in Chile have detected the "fingerprint of gaseous methyl alcohol, or methanol (CH<sub>3</sub>OH)" in protoplanetary disk TW Hydrae, according to the European Southern Observatory. This discovery will help scientists understand how organic molecules are assimilated into forming planets. ##



## E.T. Phones Earth? 1,500 Years Until Contact, Experts Estimate

20 June, 2016 – [www.space.com/33203-aliens-extraterrestrial-life-1500-years-for-contact.html](http://www.space.com/33203-aliens-extraterrestrial-life-1500-years-for-contact.html)



Earth's broadcasts reach only about 80 light-years into space. If humanity is average, then other civilizations would have reached a similar distance, covering less than a tenth of 1 percent of the Milky Way.

### INTER-STELLAR TRAVEL

#### Stephen Hawking & Russian Billionaire Want to Build Interstellar Starship

<http://gizmodo.com/a-russian-billionaire-and-stephen-hawking-want-to-build-1770467186>  
<http://gizmodo.com/watch-live-as-stephen-hawking-deliver-a-mysterious-anno-1770489990>  
[www.space.com/32554-breakthrough-starshot-interstellar-alpha-centauri-nanocraft-pictures.html](http://www.space.com/32554-breakthrough-starshot-interstellar-alpha-centauri-nanocraft-pictures.html)  
[www.space.com/images/i/000/054/730/i300/starshot-starchip-alpha-centauri-160412b-02.jpg](http://www.space.com/images/i/000/054/730/i300/starshot-starchip-alpha-centauri-160412b-02.jpg)  
[www.space.com/32548-20-percent-light-speed-to-alpha-centauri-nanocraft-concept-unveiled-video.html](http://www.space.com/32548-20-percent-light-speed-to-alpha-centauri-nanocraft-concept-unveiled-video.html) **do watch this one for the most information.**

12 April, 2016 – Last year, the search for extraterrestrial intelligence got a major boost when Russian billionaire Yuri Milner unveiled a \$100 million effort to scan the skies for radio & light signals emitted by aliens. Not content to sit tight and wait for ET to hail us, Milner plans to build interstellar spacecraft.

#### Light-propelled “nanocrafts” that can travel at relativistic speeds

##### Alpha Centauri, just over 20 years after launch

In a joint announcement at the One World Observatory in New York City today, Milner and Stephen Hawking unveiled **Breakthrough Starshot**, a \$100 million research and engineering program seeking to lay the foundations for an eventual interstellar voyage. The first step of the program involves building **light-propelled “nanocrafts” that can travel at relativistic speeds—up to 20 percent the speed of light**. At such high velocities, the robotic spacecraft would **pass Pluto in three days and reach our nearest neighboring star system, Alpha Centauri, just over 20 years after launch.**

##### Starchip,” a gram scale wafer

The technology includes a “Starchip,” a gram scale wafer carrying cameras, photon thrusters, power supply, navigation, and communication equipment.

Propelling that miniature science laboratory is a “Lightsail,” a meter-sized sail that’s **only a few hundred atoms thick and weighs a couple of grams**. The light sail will be launched away from the Earth by a **phased array of lasers**, which Milner envisions carrying a combined power of over **100 Gigawatts**, similar to the power needed to lift the Space Shuttle off Earth.

##### One hundred million miles per hour

By directing that much energy at an object weighing just a few grams, **we can theoretically accelerate said object up to 100,000,000 miles per hour**—a thousand times faster than the fastest spacecraft today. The idea is to launch a **small fleet of craft toward Alpha Centauri**, allowing us to perform many, many New Horizon-like **flybys** of our nearest neighbor’s potentially habitable real-estate. ##

## 'Starshot' Interstellar Probes May Hunt for Alien Life Close to Home

13 April, 2016 – [www.space.com/32558-starshot-interstellar-probes-alien-life-solar-system.html](http://www.space.com/32558-starshot-interstellar-probes-alien-life-solar-system.html)

The tiny robotic spacecraft that Stephen Hawking and his colleagues plan to send between the stars could also revolutionize the hunt for alien life in Earth's own solar system. But the nanocraft may first cut their teeth much closer to home. As a preliminary step, it will visit targets within the solar system, such as Saturn's moon **Enceladus**, which harbors an ocean of liquid water beneath its icy shell, as a good target for Starshot probes. Geysers erupt continuously from Enceladus' south polar region, blasting material from the hidden ocean far out into space. Another icy moon that has an underground ocean — Jupiter's moon **Europa** — would make sense as well,

"Supposing there are fish swimming in Europa's ocean, occasionally there will be an asteroid impact or a comet impact splashing huge amounts of water out onto the surface, so there should be lots of freeze-dried fish lying around"

And of course, the most unique and special moon of all, Saturn's **Titan**.

## No Breakthrough Yet: Hawking's Interstellar 'Starshot' Faces Challenges

[www.space.com/32592-breakthrough-starshot-interstellar-laser-sail-challenges.html](http://www.space.com/32592-breakthrough-starshot-interstellar-laser-sail-challenges.html)

15 April, 2016 – Making Starshot happen doesn't depend on a huge technological leap, such as would be required to make fusion power feasible. But the project still faces significant challenges.

- If too much energy is absorbed by a Starshot sail, it could very well melt.
- The interstellar medium isn't zero, meaning that the probes might hit something.
- A hydrogen atom moving that fast is a cosmic ray. Electronics don't like that.
- A particle the size of a sand grain would deliver the same energy to a Starshot probe as a pound (0.5 kilograms) of TNT, potentially destroying the tiny spacecraft entirely. But, hundreds or thousands of Starshot probes would probably be launched to each interstellar destination, so losing a few wouldn't be a big deal.
- Another issue will be the acceleration. Starshot probes will be pushed to their cruising speed in about 2 minutes, absorbing a G-force of about 51,000. Electronics are fairly robust, but none have been tested under those conditions.
- Finally, there are the challenges posed by building a laser big and powerful enough to push the spacecraft to such tremendous speeds. The laser would be a type called a phased array, which involves using lots of lasing elements to create a single combined beam that can be steered without needing a huge mechanical apparatus. ##

## Interstellar EmDrive gets boost from new theory of inertia

[www.spacedaily.com/reports/Interstellar\\_EmDrive\\_gets\\_boost\\_from\\_new\\_theory\\_of\\_inertia\\_999.html](http://www.spacedaily.com/reports/Interstellar_EmDrive_gets_boost_from_new_theory_of_inertia_999.html)

2 May, 2016 – A researcher from the UK has put forward a theory for how the EmDrive, an electromagnetic propulsion drive, might work. Roger Shawyer proposed that a propellant-less thruster, capable of launching satellites into the far reaches of space, can be created by repeatedly bouncing microwaves back and forth in a truncated cone, which creates thrust towards the narrow end of the cone.

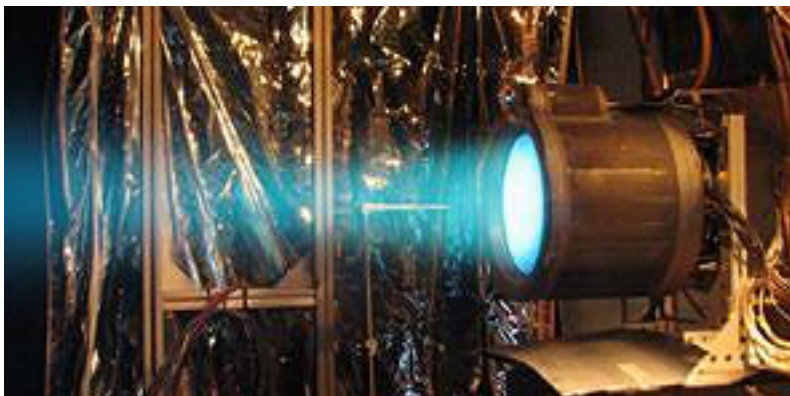

But Sawyer was not able to explain how the system is able to increase its momentum; this contradicts the law of momentum conservation, which states that momentum is neither created nor destroyed, but only changes through the action of forces, as described by Newton's laws of motion.

Despite the theoretical uncertainty, Sawyer's controversial technology has been found to create small amounts of thrust by scientists in China and most recently by a NASA experiment, which successfully tested the EmDrive in a vacuum for the first time. ##

## A Neptune-mass alien world with Earth-like density

<http://phys.org/news/2016-05-astronomers-neptune-mass-alien-world-earth-like.html>

17 May, 2016 - According to the research, the newly detected alien world, designated EPIC212521166 b, is the most massive planet with a sub-Neptune radius found to date. It is an 8 billion-year-old, metal-poor dwarf star with a mass of slightly more than 0.7 solar masses, located some 380 light years away. The planet is expected to have a large rocky core. The researchers computed that the core must be composed mostly of enstatite (70 percent) and iron (30 percent). They also argue that the planet could have significant water content and a hydrogen-helium atmosphere. ##

## 'Electric wind' can strip Earth-like planets of oceans, atmospheres

20 June, 2016 - <http://phys.org/news/2016-06-strong-electric-planets-oceans-atmospheres.html>



The space environment around a planet plays a key role in determining what molecules exist in the atmosphere -- and whether the planet is habitable for life. New NASA research shows that the electric fields around Venus helped. ##

## OUR MILKY WAY GALAXY

### Supermassive black holes may be lurking everywhere in the universe

April 6, 2016 - <http://phys.org/news/2016-04-supermassive-black-holes-lurking-universe.html>

A near-record supermassive black hole - equal to 17 billion suns - has been discovered in a sparse area of the local universe. These monster objects may be more common than once thought.

### Measuring the Milky Way: One massive problem, one new solution

31 May, 2016 - <http://phys.org/news/2016-05-milky-massive-problem-solution.html>

#### What is the mass of the Milky Way?

The short answer, in terms that are easier to comprehend, is about the mass of our Sun, multiplied by 700 billion. The Sun, for the record, is some 330,000 times the mass of Earth.

Measuring the mass of our home galaxy, or any galaxy, is particularly difficult. A galaxy includes not only stars, planets, moons, gases, dust and other objects and material, but also a big helping of dark matter, a mysterious and invisible form of matter that is not yet fully understood and has not been directly detected in the lab. Astronomers and cosmologists, however, can infer the presence of dark matter through its gravitational influence on visible objects. **Read on!**

## An algorithm to image black holes

6 May, 2016 - <http://phys.org/news/2016-06-algorithm-image-black-holes.html>



An artist's drawing a black hole named Cygnus X-1. It formed when a large star caved in. This black hole pulls matter from the blue star beside it

Researchers from MIT's Computer Science and Artificial Intelligence Laboratory and Harvard U; have developed a new algorithm that could help astronomers produce the first image of a black hole.

The algorithm would stitch together data collected from [radio telescopes](#) scattered around the globe, under the auspices of an international collaboration called the Event Horizon Telescope. The project seeks, essentially, to turn the entire planet into a large radio telescope dish.

Radio wavelengths come with a lot of advantages, Just like how radio frequencies will go through walls, they pierce through galactic dust. ##

## Gravitational Wave Detector Finds Double Colliding Black Holes — Again

15 June, 2016 [www.space.com/33176-gravitational-waves-from-second-black-hole-collision.html](http://www.space.com/33176-gravitational-waves-from-second-black-hole-collision.html)  
[www.space.com/33175-again-gravitational-waves-detected-from-2nd-black-hole-collision-video.html](http://www.space.com/33175-again-gravitational-waves-detected-from-2nd-black-hole-collision-video.html)  
[www.space.com/33199-why-are-gravitational-waves-important.html](http://www.space.com/33199-why-are-gravitational-waves-important.html)

Distortions in the fabric of space-time, which were predicted by Albert Einstein a century ago, have been directly detected for the second time. **Approximately 1.4 billion light-years from Earth, two black holes spiraled around each other and collided, creating ripples in the fabric of space-time. These ripples, known as gravitational waves, arrived at Earth in December 2015, and were detected by the Laser Interferometer Gravitational Wave Observatory (LIGO).** ##

## Network theory helps solve mystery of stellar initial mass function

7 June, 2016 - <http://phys.org/news/2016-06-network-theory-mystery-stellar-mass.html>

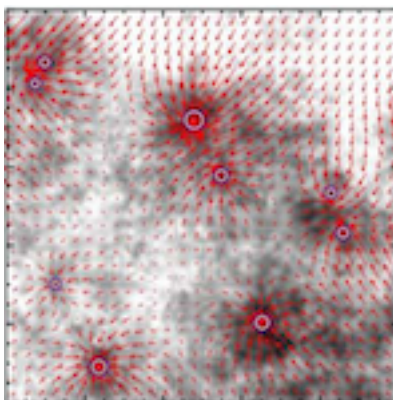

A model of the interstellar medium having a fractal density distribution. Dense cores where proto-stars are forming are marked and gravitational forces generated by them are shown

For the first time, scientists have used methods of network science to solve a fundamental astrophysical problem—explaining the so-called "stellar initial mass function," a distribution of stars by mass in galaxies and star clusters. The stellar initial mass function describes the relative fractions of stars with different masses in a stellar system or a ratio of big and small stars in galaxies. ##

## Computer simulations shed light on the Milky Way's missing red giants

7 June, 2016 - <http://phys.org/news/2016-06-simulations-milky-red-giants.html>

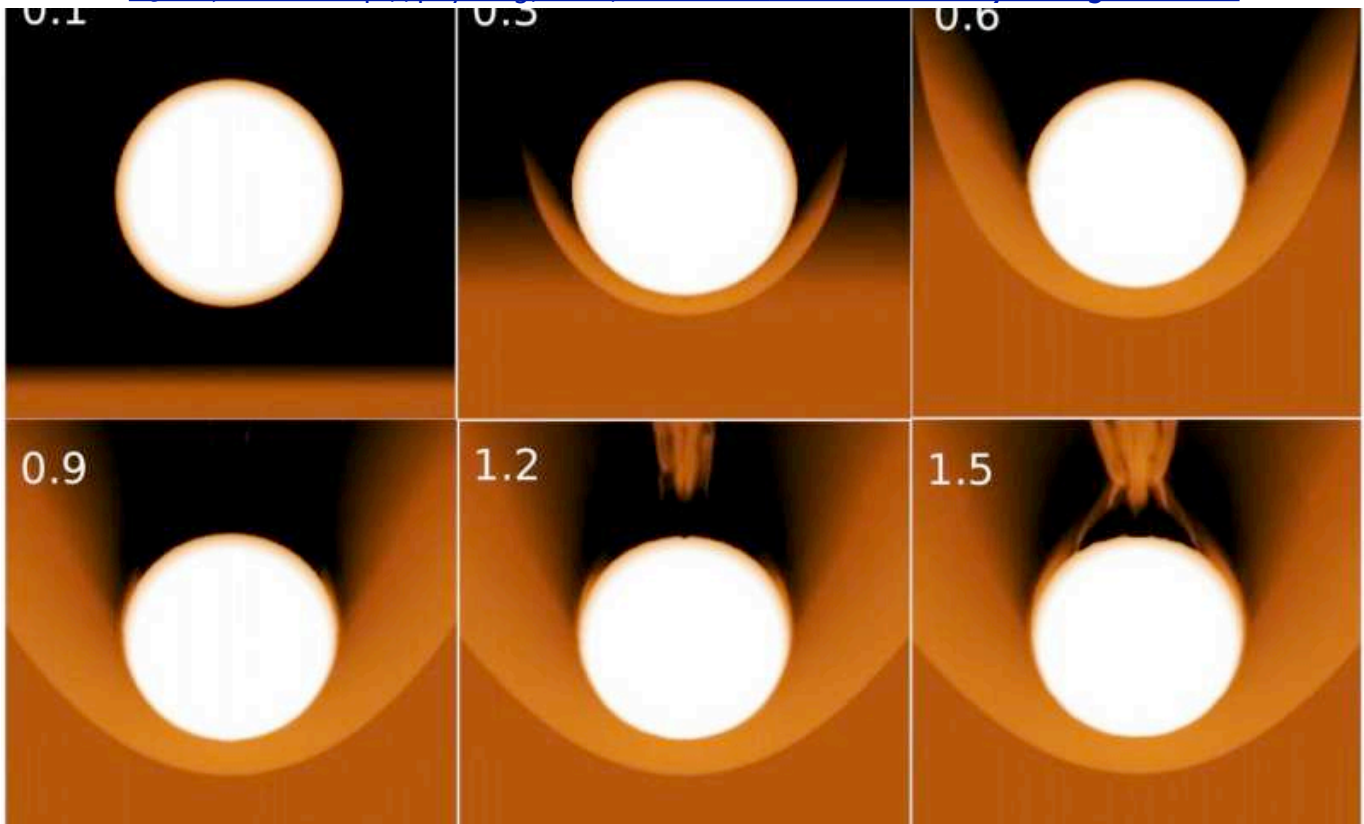

New computer simulations from the Georgia Institute of Technology provide a conclusive test for a hypothesis of why the center of the Milky Way appears to be filled with young stars but has very few old ones. According to the theory, the remnants of older, red giant stars are still there—they just aren't bright enough to be detected with telescopes. ##

## Measuring the shape of the Milky Way's black hole

25 June, 2016 - <http://phys.org/news/2016-06-milky-black-hole.html>

At the heart of our galaxy's center is SagA\*, a supermassive black hole containing about four million solar-masses of material. SgrA\* is relatively faint, unlike the supermassive black holes in some other galaxies. This is probably because, unlike its active cousins, it is not aggressively accreting material and so is neither heating up its environment nor ejecting particularly intense jets of fast-moving charged particles.

Of course, it is also faint because it is located about twenty-five thousand light years from Earth and because it is shrouded in absorbing, intervening dust. Nevertheless, radiation at radio, submillimeter, infrared and X-rays can penetrate the veiling material. As the closest super massive black hole to Earth, SgA\* is a template for astronomers actively studying black holes, offering the best views of the physical properties and environments. The radio emission in particular is thought to come from material falling onto a disk around the black hole and heating up electrons, and from ejected material both within the jet itself and its nozzle.

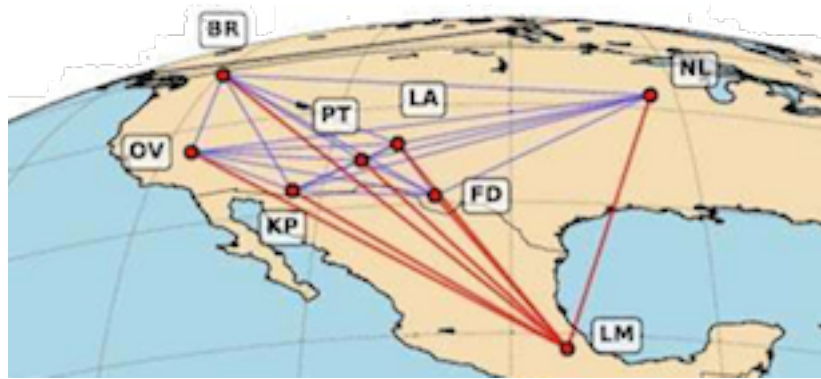

This figure shows the locations of the radio telescopes linked together to observe the supermassive black hole at the center of our Milky Way

One of the most exciting new projects studying SgrA\* uses Very Long Baseline Interferometry (VLBI) techniques, which links an array of widely-spaced radio telescopes to obtain very high spatial resolutions. A team was successfully able to model its size, thanks to the inclusion in the array for the first time of the Large Millimeter Telescope Alfonso Serrano in Mexico. ##

## Successful first observations of galactic center with GRAVITY

23 June, 2016 – <http://phys.org/news/2016-06-successful-galactic-center-gravity.html>  
[www.space.com/33270-black-hole-imager-captures-first-view-of-galactic-core.html](http://www.space.com/33270-black-hole-imager-captures-first-view-of-galactic-core.html)

The GRAVITY instrument is now operating with the four 8.2-metre Unit Telescopes of ESO's Very Large Telescope (VLT). From early test results show that it will soon be producing world-class science.

By combining light from the four telescopes it can achieve the same spatial resolution and precision in measuring positions as a telescope of up to 130 metres in diameter. The corresponding gains in resolving power and positional accuracy—a factor of 15 over the individual 8.2-metre VLT Unit Telescopes—will enable GRAVITY to make amazingly accurate measurements of astronomical objects.

One of GRAVITY's primary goals is to make detailed observations of the surroundings of the 4 million solar mass black hole at the very centre of the Milky Way. Although the position and mass of the black hole have been known since 2002, by making precision measurements of the motions of stars orbiting it, GRAVITY will allow astronomers to probe the gravitational field around the black hole in unprecedented detail, providing a unique test of Einstein's general theory of relativity. ##

## THE UNIVERSE AT LARGE

### Testing the Multiverse: Beyond the Limits of Science? (Op-Ed)

<http://www.space.com/32452-can-science-explain-the-multiverse.html>

If there is a “Multiverse” out there, can we “see” it?

The idea of a multiverse, the theory that there are **many** universes, **multiple** universes, **innumerable** universes, or perhaps **an infinite number of universes**. **Editor:** my vote is for the latter. ##

### The Universe Has Probably Hosted Many Alien Civilizations: Study

5 May, 2016 – [www.space.com/32793-intelligent-alien-life-probability-high.html](http://www.space.com/32793-intelligent-alien-life-probability-high.html)  
[www.space.com/33175-again-gravitational-waves-detected-from-2nd-black-hole-collision-video.html](http://www.space.com/33175-again-gravitational-waves-detected-from-2nd-black-hole-collision-video.html)

The probability of a civilization developing on a potentially habitable alien planet would have to be “**less than one in 10 billion trillion**” — or one part in 10 to the 22nd power — for humanity to be the first technologically advanced species the cosmos has ever known, according to the study.

Many other planets throughout the universe probably hosted intelligent life long before Earth did.##  
**Editor:** Consider the vastness of our Milky Way galaxy, only one of hundreds of millions of other galaxies in our universe - and that there may be countless other universes, each in its own space and time. ##

## Exoplanets' complex orbital structure & planetary migration

<http://phys.org/news/2016-05-exoplanets-complex-orbital-planetary-migration.html>

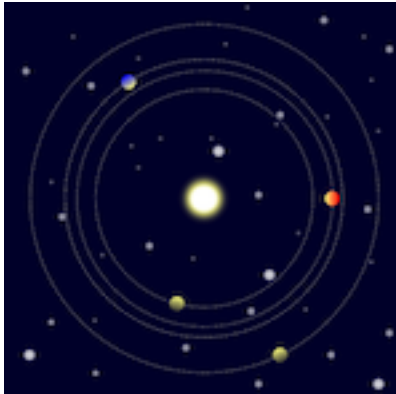

11 May, 2016 – The four planets of the Kepler-223 star system seem to have little in common with the planets of Earth's own solar system. And yet a new study shows that the Kepler-223 system is trapped in an orbital configuration that Jupiter, Saturn, Uranus, and Neptune may have broken from in the early history of the solar system.

The orbital configuration of the solar system seems to have evolved since its birth 4.6 billion years ago. The four known planets of the much older Kepler-223 system, however, have maintained one orbital configuration for far longer.

The planets of Kepler-223 are much larger than Earth, likely consisting of a solid core and an envelope of gas, and they orbit their star in periods ranging from only seven to 19 days. Astronomers call these planets **sub-Neptunes**. They are the most common type of planets known in the galaxy. ##

## Einstein Theory of Relativity holds true for Early Universe, 3D Map Confirms

13 May, 2016 – [www.space.com/32870-3d-universe-map-confirms-einstein-general-relativity.html](http://www.space.com/32870-3d-universe-map-confirms-einstein-general-relativity.html)

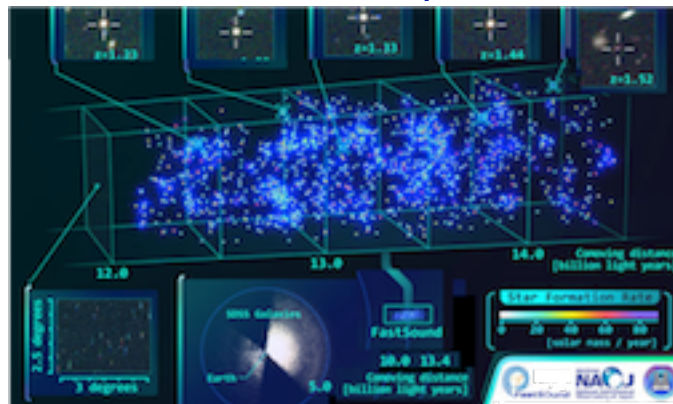

**Full size:** [http://www.space.com/images/i/000/055/438/original/subaru\\_telescope\\_3d\\_universe.jpg](http://www.space.com/images/i/000/055/438/original/subaru_telescope_3d_universe.jpg)

A 3D map of the universe from 12 to 14.5 billion light-years away. Analyzing the positions of ancient galaxies helped a team of scientists verify Einstein's general theory of relativity, which describes how gravity warps space and time. ##

## NASA Telescopes Find Clues For How Giant Black Holes Formed So Quickly

[www.nasa.gov/press-release/nasa-telescopes-find-clues-for-how-giant-black-holes-formed-so-quickly](http://www.nasa.gov/press-release/nasa-telescopes-find-clues-for-how-giant-black-holes-formed-so-quickly)

26 May, 2013 – Scientists believe a supermassive black hole lies in the center of nearly all large galaxies, including our own Milky Way. They have found that some of these supermassive black holes, which contain millions or even billions of times the mass of the sun, formed less than a billion years after the start of the universe in the Big Bang.

Their discovery, if confirmed, explains how these monster black holes were born. They found evidence that supermassive black hole seeds can form directly from the collapse of a giant gas cloud, skipping any intermediate steps.

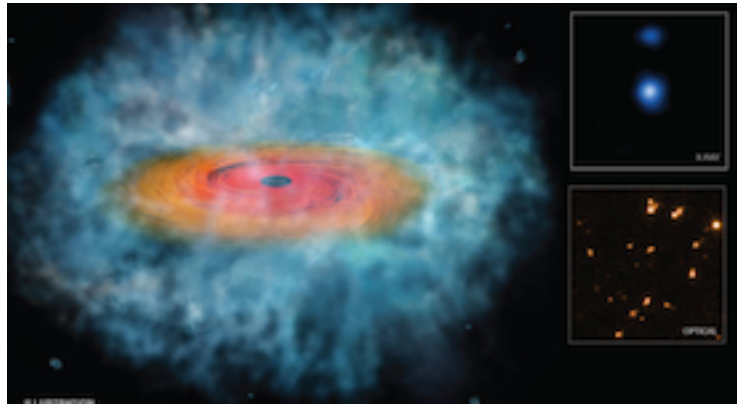

This illustration represents the best evidence to date that the direct collapse of a gas cloud produced supermassive black holes in the early Universe. Researchers combined data from NASA's Chandra, Hubble, and Spitzer telescopes to make this discovery. ##

## Surprise! The Universe Is Expanding Faster Than Scientists Thought

2 June, 2016 - [www.space.com/33061-universe-expanding-faster-than-thought-hubble.html](http://www.space.com/33061-universe-expanding-faster-than-thought-hubble.html)



Hubble Space Telescope view of the galaxy UGC 9391, which contains Cepheid variable stars and supernovas that scientists studied to calculate a newly precise value for Hubble's constant.

## Predicting how the first clumps of matter formed & our universe's future

<http://phys.org/news/2016-06-clumpsof-matterformed-universe-future.html#jCp>

23 June, 2016 - Our universe came to life nearly 14 billion years ago in the Big Bang—a tremendously energetic fireball from which the cosmos has been expanding ever since. Today, space is filled with hundreds of billions of galaxies, including our solar system's own galactic home, the Milky Way. But how exactly did the infant universe develop into its current state, and what does it tell us about our future? #

## Dormant black hole eats star, becomes X-ray flashlight

22 June, 2016 - <http://phys.org/news/2016-06-dormant-black-hole-star-x-ray.html>

Astronomers at two universities are the first to document X-rays bouncing around deep within the walls of a once-dormant black hole's newly formed accretion disk—the giant, puffy cloud of shredded star stuff circling the black hole, waiting for its turn to be swallowed up—following a tidal disruption event. Using these data, the researchers discerned the shape and activity of the accretion disk near a supermassive black hole named Swift J1644+57.

This marks the first time such detailed observations have been made for a dormant supermassive black hole.



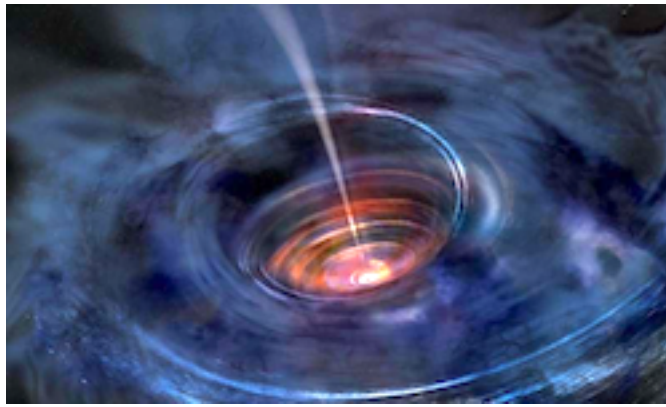

A thick accretion disk has formed around a supermassive black hole following the tidal disruption of a star that wandered too close. Stellar debris has fallen toward the black hole and collected into a thick, ...more

Roughly 90 percent of the biggest black holes in the known universe are dormant, meaning that they are not actively devouring matter and, consequently, not giving off any light or other radiation. But sometimes a star wanders too close to a dormant black hole and the ensuing feeding frenzy, known as a tidal disruption event, sets off spectacular fireworks. ##

### Team predicts a universe crowded with black holes

22 June, 2016 - <http://phys.org/news/2016-06-team-universe-crowded-black-holes.html>

A new study published in Nature presents one of the most complete models of matter in the universe and predicts hundreds of massive black hole mergers each year observable with the second generation of gravitational wave detectors.

### The Universe's First Galaxies May Light Up Its Dark Ages

28 June, 2016 = <http://www.space.com/33284-first-galaxies-lit-up-dark-ages.html>

A collection of newfound galaxies is illuminating how the early universe broke free from its Dark Ages. The family of galaxies may have played a role in the shift from a time when some light could not penetrate to an era of a transparent universe.

"Stars and black holes in the earliest, brightest galaxies must have pumped out so much ultraviolet light that they quickly broke up hydrogen atoms in the surrounding universe." ##



## To The Stars International Quarterly Editorial Team

TTSIQ is a project of the National Space Society's International Committee



**L>R:** Peter Kokh – [kokhmm@aol.com](mailto:kokhmm@aol.com) – [http://www.lunarpedia.org/index.php?title=Peter\\_Kokh](http://www.lunarpedia.org/index.php?title=Peter_Kokh)  
President Milwaukee Lunar Reclamation Society – Editor of Moon Miners' Manifesto – Life member National Space Society – Past president the Moon Society 2004–2011, Milwaukee, Wisconsin US

**Madhu Thangavelu** – [thangavelu-girardey@cox.net](mailto:thangavelu-girardey@cox.net) – Mother from Kerala, Father from Tamil Nadu – grew up in Delhi – now teaching at the University of Southern California – Conductor, Graduate Space Exploration Concept Studio USC School of Engineering & Architecture – co-author of "The Moon: Resources, Future Development, and Settlement". – Los Angeles, California US

**David A. Dunlop** – [dunlop712@yahoo.com](mailto:dunlop712@yahoo.com) – Moon Society Director of Project Development – Executive Director of LUNAX (Lunar National Agriculture eXperiment) – University of Luna Project – Chair NSS International Committee – Green Bay, Wisconsin US

**Al Anzaldua** – [alanzaldua706@yahoo.com](mailto:alanzaldua706@yahoo.com) – President Tucson L5 Space Society, Tucson, Arizona, US



**L:** Srinivas Laxman – [moonshotindia@gmail.com](mailto:moonshotindia@gmail.com) – Mumbai – author "MoonShot India: The Story of India's Mission to the Moon;" and 3 other books: Dreams To Reality--bio of Dr APJ Abdul Kalam; Mars Beckons India--The Story of India's Mission To Mars and recently Indian Martian Odyssey.

**M:** Lynn Zielinski, NSS Educational Committee – [lzielinski@comcast.net](mailto:lzielinski@comcast.net) – Chicago, Illinois, US

**R:** Student Contributor: Aleksandra Voinea – [aleksa.voinea@gmail.com](mailto:aleksa.voinea@gmail.com) – Bucharest, Romania, Yale U. Ithaca, NY

**NOTE: Opinions expressed in the Articles & Essays section below** are those of the individual writers and do not imply any editorial philosophy of TTSIQ. The TTSIQ editorial team consists of persons of various backgrounds who are free to express their own opinions and interpretations.

**We welcome additional co-Editors and Contributors  
As well as Reporters from various nations and student groups**

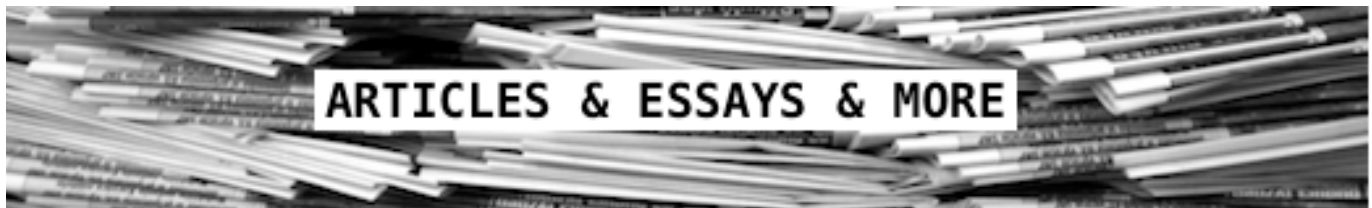

## For our Yuri's Night Party, MLRS produced a list of more "Human Space Frsts"

By Peter Kokh, Milwaukee Lunar Reclamation Society – ( List additions and corrections welcome! )

**1<sup>st</sup> to orbit more than once Gherman Titov** first person to orbit the Earth multiple times (a total of 17), to spend more than a day in space, to sleep in orbit and to suffer from space sickness **August 6, 1961**

**1<sup>st</sup> woman in space: Valentina Tereshkoca: on Vostok 6, June, 16 1963**

**1<sup>st</sup> spacewalk: Alexey Leonov: on March 18, 1965**, he became the first human to conduct extraehicular acitivity (EVA) – **the first space walk**., exiting the capsule during the [Voskhod 2](#) mission for 12-minute spacewalk.

**1st hookup in space Apollo–Soyuz July 17, 1965 Tom Stafford and Alex Leonov** shake hands: also on this mission, **Vance Brand and Deke Slayton (US) and Valeri Kubsov (USSR)**

**1<sup>st</sup> trip around the Moon, Apollo 8, December 24, 1968 – also**

- First persons to pass through the Van Allen belts
- First persons to travel beyond low Earth orbit
- First persons to travel out of sight of Earth (behind the Moon)
- First persons to see an "Earthrise"

Commander **Frank Borman**, Command Module Pilot **James Lovell**, and Lunar Module Pilot **William Anders** — became the first humans to travel **beyond low Earth orbit**, the first to **see Earth as a whole planet**, the first to directly **see the far side of the Moon**, and then the first to witness **Earthrise**. maximum distance from Earth of 203,752 nautical miles (234,474 statute miles; 377,349 kilometers)

**1st bootpoment on the Moon: Apollo 11: Neil Armstorng (1), Buzz Aldrin (2) on July 20, 1969**

**The first space station, Salyut 1**, was launched by the Soviet Union on April 19, 1971 with cosmonauts **Vladimir Shatalov, Aleksei Yeliseyev, and Nikolai Rukavishnikov** on board. **They were the first persons to die in space.**

**1<sup>st</sup> drive on the Moon: Jim Irwin** with the Lunar Roving Vehicle, Apollo 15, July 31, 1971

**We welcome additions and corrections!** As well as a list of human firsts yet to be realized.

**Note:** While I did list the first woman in space, in general, this is a list of first person achievements, which happens to "male heavy" If I were to make an addition, it would be (below):

**The first person to sing "country" in space, Shannon Lucid**, on the Mir EO-21 mission, March 22–Sept. 26, 1996

Do purchase the DVD of her singing country music on board MIR (along with Russian "Country" by the cosmonauts – <http://www.amazon.com/Mission-To-Mir-IMAX-VHS/dp/B00005MEPF>)

**Possible additions to this list:**

- **First person to spend more than 2 years in space: Gennady Padalka**, 879 days in space over 5 missions,
- **First Crew to Repair a Satellite: the Hubble Space Telescope: Shuttle Endeavour Mission STS 61, December 2–3, 1983 – Kathryn Thornton and Tom Akers** six hours, 35 minutes

**Feats to come**

- ✓ First person to go beyond Earth orbit
- ✓ First person to relocate to the Moon for the rest of his/her life and leave Earth behind
- ✓ First person to set foot on Mars
- ✓ First person to go to Mars to stay
- ✓ First crew to visit Mercury Etc. Etc.

Comments: [kokhmmm@aol.com](mailto:kokhmmm@aol.com)

**Out of Africa – to Beyond Earth – to Beyond the Solar System – to t\he Stars!**

## Geologically “Earthlike” worlds without a large moon might not host life

By Peter Kokh

[www.space-travel.com/reports/The\\_Moon\\_thought\\_to\\_play\\_a\\_major\\_role\\_in\\_maintaining\\_Earths\\_magnetic\\_field\\_999.html](http://www.space-travel.com/reports/The_Moon_thought_to_play_a_major_role_in_maintaining_Earths_magnetic_field_999.html)

[www.spxdaily.com/images-lg/gravitational-effects-lunar-sun-cyclical-deformation-earth-mantle-wobble-rotation-axis-lg.jpg](http://www.spxdaily.com/images-lg/gravitational-effects-lunar-sun-cyclical-deformation-earth-mantle-wobble-rotation-axis-lg.jpg)

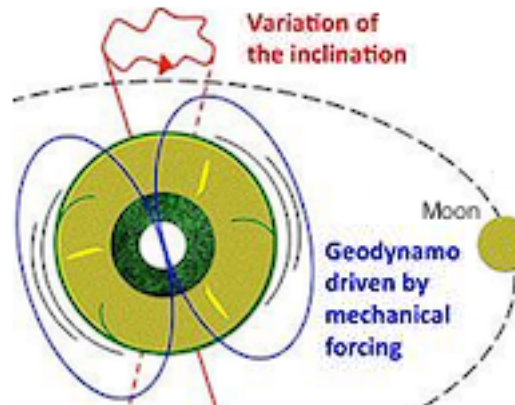

The gravitational effects associated with the presence of the Moon and Sun cause **cyclical deformation of the Earth's mantle and wobbles in its rotation axis.**

**This mechanical forcing applied to the whole planet causes strong currents in the outer core, which is made up of a liquid iron alloy of very low viscosity.**

**Such currents are enough to generate the Earth's magnetic field.**

Given the protection Earth's magnetic field gives us – the **Van Allen Belts** – this could mean that otherwise Earthlike planets i.e. Possessing **continents and oceans** – but **without a sizable moon** – **might not support life** as Earth does.

**Being in a star's “Goldilocks Zone” may not be enough** Astronomers finding “Earth-size” planets in the “Goldilocks Zone” of its sun (in an orbital range where liquid water is possible) need to keep looking for “wobbles” that indicate the presence of a relatively large moon.

**This might make worlds like ours even more rare and special than previously thought**

**Note: The Moon is already a key anchor of a Greater Earth “Econosphere”**

(a cheaper source of building materials for use in GeoSynchronous Orbit than Earth's surface) and, by **ocean tides**, has also reduced Earth's rotation rate over billions of years from c. 10 hours to 24.

**Perhaps we should recognize this dynamic Earth–Moon relationship as the 1st known instance of a 2nd class of “Binary Planet”**

**“Earth–Moon”** [English], **“Terra–Luna”** [Latin], **“Gaia–Selene”** {Greek}

**Suggested definition:** “the center of gravity of the planet and its moon is **within the planet's mantle**” [rather than between the pair, as is the case with Pluto–Charon] ##

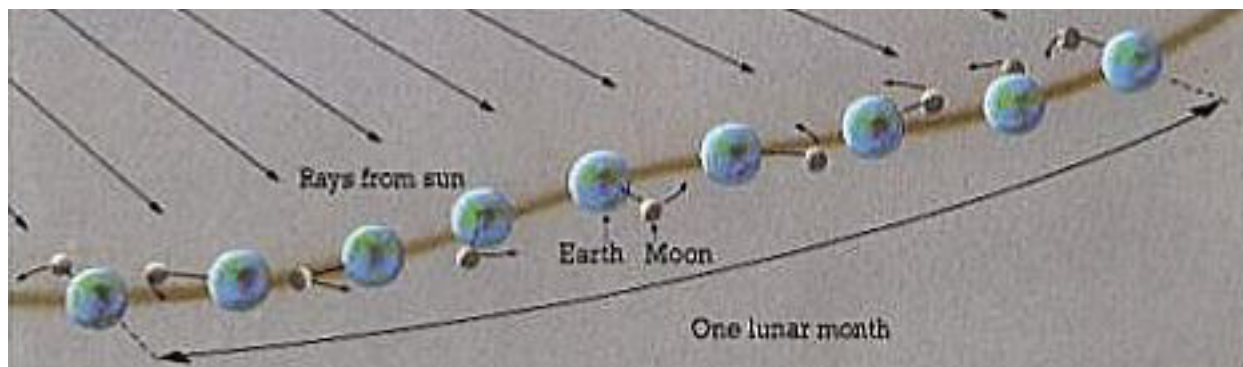

<http://www.discover-sedgefield-south-africa.com/images/Moonphases1.jpg>

**Above:** Earth's orbit has these weaving waves due to the Moon's gravitational influence. **PK**

Past TTSIQ issues are online at: [www.moonsociety.org/international/ttsiq/](http://www.moonsociety.org/international/ttsiq/) and at: [www.nss.org/tothestars/](http://www.nss.org/tothestars/)

## At last, the BEAM inflatable test module is attached to the Space Station

By Peter Kokh

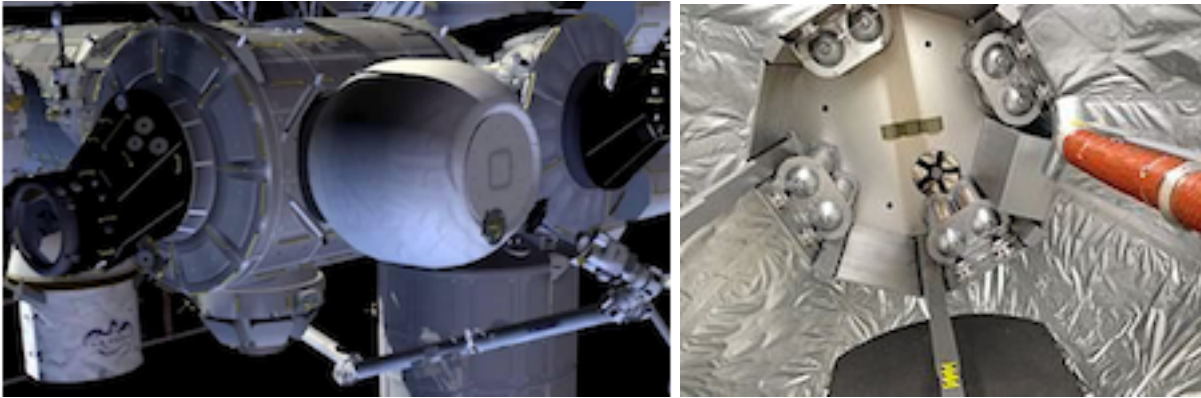

“The **Bigelow Expandable Activity Module (BEAM)** is an experimental program developed under a NASA contract in an effort to test and validate **expandable habitat technology**. Although BEAM is a fraction of the size of the B330, it will still serve as a vital pathfinder for validating the benefits of expandable habitats. NASA will leverage the International Space Station (ISS) in order to test this technology for a two-year demonstration period.” – <http://bigelowaerospace.com/beam/> BEAM was part of the cargo brought up to ISS by the Space-X Dragon freight capsule April 10, 2016.

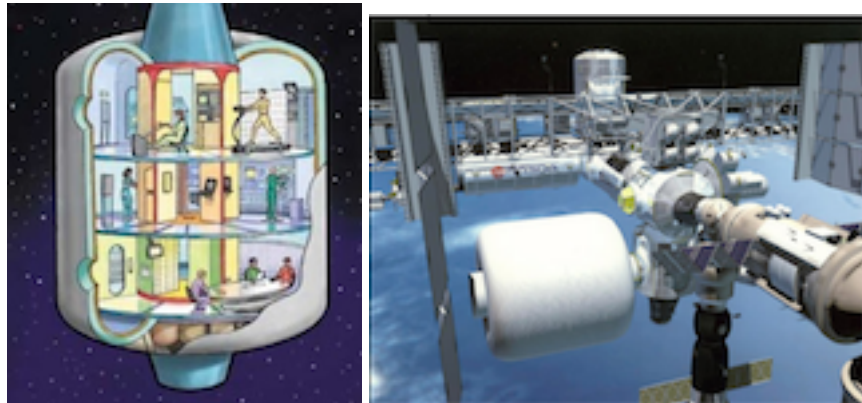

<http://spaceflight.nasa.gov/history/station/transhab/>

But twenty years ago, NASA was planning to bring a much larger three-floored inflatable with advanced internal structure, **TransHab** { short for “transit habitat” }. It was multi-floored and had a structural core for passage from floor to floor and to the Station to which it was to be attached.

“Considerable controversy arose during the TransHab development effort due to delays and increased costs of the ISS program. In 1999, the National Space Society issued a policy statement recommending that NASA continue R&D of inflatable technologies while ceasing development of a TransHab ISS module.<sup>[3]</sup> Finally in 2000, despite objections from the White House<sup>1</sup> House Resolution 1654 was signed into law banning NASA from conducting further research and development of TransHab. An option to lease an inflatable habitat module from private industry was included in the bill.” – <https://en.wikipedia.org/wiki/TransHab>

NASA licensed the TransHab technology to Bigelow Aerospace which has sought to develop it for commercial applications. The BEAM module will allow NASA to test it structurally. Unfortunately, perhaps for money and transportation considerations, NASA did not want a larger module which could have served as a free fall recreational area for astronauts – something that would get public attention.

We ourselves have explored various design directions.

[http://www.moonsociety.org/publications/mmm\\_papers/transhab.htm](http://www.moonsociety.org/publications/mmm_papers/transhab.htm)

[http://www.moonsociety.org/publications/mmm\\_papers/hostels\\_paper1.htm](http://www.moonsociety.org/publications/mmm_papers/hostels_paper1.htm) – excerpt below

**Flash: Bigelow Aerospace & United Launch Alliance to put Bigelow 330s in orbit in 2020**

[www.spacedaily.com/reports/prnewswire-space-news.html?rkey=20160411SF68855&filter=1639](http://www.spacedaily.com/reports/prnewswire-space-news.html?rkey=20160411SF68855&filter=1639) ##

Past TTSIQ issues are online at: [www.moonsociety.org/international/ttsiq/](http://www.moonsociety.org/international/ttsiq/) and at: [www.nss.org/tothestars/](http://www.nss.org/tothestars/)

Our paper **The Lunar Hostel: An Alternate Concept for First Beachhead and Secondary Outposts** was presented at the 1991 International Space Development Conference in San Antonio. This paper is not currently online or available in pdf format. The original illustrations were hand drawn. The idea was to find a way to pack larger habitat structures into the space shuttle payload bay.

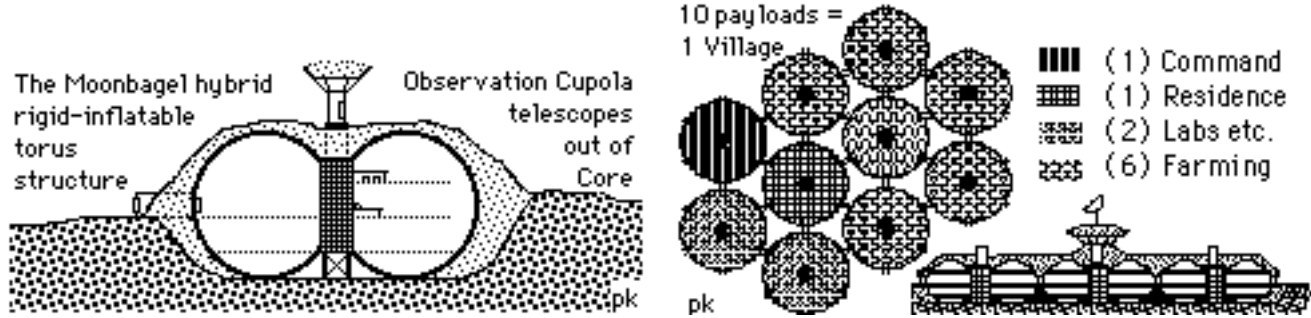

Left: You will note from the profile that such a multi-floor structure might be ideal for setting in a properly sized crater as that would minimize excavation.

Right: Here is an example of how such structures could be "ganged" into large complexes: **The donut concept could be tested at the Mars Desert Research Station**



Left: <http://www.jebiga.com/camping-doughnut-tent/>

Picture the commercially available inflatable donut wrapped around the base of the "Hab" to provide more spacious sleeping quarters (now crammed into part of the hab 2nd floor) freeing that space for other operations functions. The donut" addition could be covered with hay bales and a canvas topped with local sand to moderate hot days and cold nights – a more realistic mission "simulations."

*(caveat: No, we do not know if the dimensions of the donut hole in the above pictured inflatable unit will match up with the width of the hab, But if it is a workable match, it would be worth pursuing.)*

Until local materials can be used to build structures on the Moon and Mars, inflatables will provide a more spacious and less expensive form of pioneer housing.



On the Moon or Mars, the "foot thick" hulls of these inflatables provide some initial insulation from thermal extremes. But covering with several yards/meters of moondust or marsdust is strongly recommended. Shielding does not have to be applied directly. An assembly such as illustrated above, could be placed under a "shielded hangar" to allow module rearrangements, additions, repairs, etc.

Inflatables provide a much more economical settlement technology for the near term. PK

## Spotting a Ringworld edge on against its sun as seen from Earth

By Peter Kokh - (submit to Space News)



<https://en.wikipedia.org/wiki/Ringworld>

( “Ringworld” is a 1970 science fiction novel by Larry Niven, set in his “Known Space” universe. )  
 The **Ringworld** itself is an artificial ring about one million miles (1.6 million kilometers) wide (In cross section) and approximately the diameter of Earth's orbit, which makes it about 600 million miles (1,000 million kilometers) in circumference),

In our system, that would be in the middle of the Asteroid Belt.

- It rotates, providing artificial gravity as strong as Earth's gravity by centrifugal force.
- The ringworld has a habitable, flat inner surface equivalent in area to approximately three million Earth-sized planets (able to support 3 million times Earth's population, at our population density.)
- Night is provided by an inner ring of shadow squares which are connected to each other by thin, ultra-strong wire (shadow-square wire).

Such an advanced civilization could be spotted if, perchance, the plane of its orbit around its sun happened to be edge on as seen from Earth. This is the same situation the Kepler Space Telescope uses to find extra-solar planets that appear as dark spots crossing the face of the star in question.

### On the other hand

Now, such an hyper-advanced civilization may be able to disguise itself by techniques that force the field of view in any direction to skip around the ringworld – should it not want to be “found.” Architects are experimenting with such techniques here on Earth, for example, a new skyscraper in Incheon (port of Seoul), Korea, is designed to be seen through, thus invisible. How? Easy. The invisibility illusion is to be achieved with a high-tech LED facade system in which each screen shows the view of the city from the opposite side of the building.

Read: [https://en.wikipedia.org/wiki/Tower\\_Infinity](https://en.wikipedia.org/wiki/Tower_Infinity)

We might not be able to find such civilizations by this “edge-on against its sun method” if they did not want anyone to find them.

### But why would they hide?

But why should such an advanced civilization want to hide itself? It is one thing to be seen at the speed of light, and quite another to be visited and decidedly sub-light speeds. Indeed, they would want to be seen. Civilizations like ours, primitive in comparison, will be inspired to know that such advances are possible.

The farther away we find such structures, the further into the past we are looking. And the further we look into the past, the less frequent will be such epitomes of intelligent civilization. Why, because at the speed of light we are still looking into the past. The further away, the further into the past and the less likely we are to find such advanced civilizations.

Finding such a civilization could be the single most energizing and inspiring event in the history of humankind. We would know that if we got our act together our civilization might someday reach similar heights.

### Right now we are not headed in that direction

We can start by stopping the destruction of our precious world for short term (“to hell with our grandchildren”) selfish greed. ##

## A US Department of Space

By Madhu Thangavelu

Conductor, ASTE 527 Graduate Space Concepts Studio  
Dept. of Astronautical Engineering and the School of Architecture  
University of Southern California

[http://www.usc.edu/ur/federal\\_relations/experts/bios/1073.html](http://www.usc.edu/ur/federal_relations/experts/bios/1073.html)

It was heartening to see President Obama's tweet to congratulate Space-X on that picture perfect first stage touchdown on their "of course I still love you" drone ship in the Atlantic last week, heralding the arrival of a new era in rocketry, emphasizing affordability and sustainability, the hallmarks of the NewSpace movement. At the same time, it is perplexing that not one of the presidential candidates running for office has yet to mention, let alone pay lip service to the nation's space program that put, not one, but a dozen people on the Moon and brought them back safely, changing humanity's reach, aspirations and worldview forever.

Perhaps now is the time for candidates aspiring for the highest office to start painting bold visions for America's future, to consider a US Department of Space that can play a vital role both in the domestic and in the international policy of our nation. Besides helping to build up infrastructure of friendly nations, align the projects and goals of various spacefaring nations, assist in global space projects like space based solar power or building a planetary defense system to thwart potentially hazardous asteroids and comets, creating and running international manned missions to Mars, orbital space debris mitigation and monitoring and tackling various aspects of climate change, a Department of Space would also help to coordinate the activities of private fledgling space companies here in America,.

A range of options available to the next administration include asking NASA to play the role of global coordinator at one end to proposing a completely new organization and charter for space activity on the other. NASA could, in theory, create a new division to coordinate such activity, evolving and extending the ISS model of international collaboration, but such activity would clearly distract resources and personnel from NASA's leading-edge space technology and mission charter, and detract from the agency's core competence. The creation of a US Department of Space might however help to balance these two poles, and perhaps even play a catalytic role. And the private space sector could use a moderating, synergizing body between it and the government space sector.

Even before the imminent arrival of routine suborbital space tourism flights by Virgin Galactic, the FAA is involved, studying the potential impact and safety on airline traffic. As commercial space flight comes of age, we can expect the Dept. of Commerce, NOAA and OSHA to become important players as well. And the State Department has already played a notoriously myopic role in suppressing space commerce and setting a highly lucrative satellite industry back for decades under the ITAR / MTCR pretext.

Global projects are different in mission and scope than national projects. Space projects like planetary defense, space based solar power platforms and orbital debris mitigation impact all people around the globe, and so such projects need a different kind of administration and charter. A world space organization along the lines of other UN agencies may be hard to evolve in the prevailing climate or from the existing charter of the UN Office of Outer Space Affairs(OOSA).

NASA has a history of being told to do too much with too little for too long and may not be able to handle all these auxiliary functions that will be thrust upon it soon without radical changes to the agency's charter. It is perhaps better for the agency to stay close to its original charter, as the administrator Mr. Bolden has done so well, and provide leadership in its area of core competence; high risk technology development and deep space, endurance-class manned missions to destinations beyond Earth orbit, to the Moon, Mars and asteroids.

A Department of Space must not be misconstrued as a threat by Congress or the administration as a way to break up NASA or split up its already stretched budget. Nor should it be portrayed as a stealthy effort by the US Department of Defense trying to exert influence globally.

An USC team project from 2011 had presented a case that the Department of Space should operate at a budget level of some 60B dollars, consistent with other departments, of which NASA should have \$20B to build, test and fly daring, leading-edge technology missions into deep space. The remaining \$40B is suggested for the Dept. of Space that will then handle all the coordination functions



between large global space infrastructure development projects, NASA and other partner nation agencies and the private sector.

Government and private space activities are both necessary to keep the space industry in good competitive shape. Just as the Human Genome Project was accelerated by Celera Genomics, a small biotech company, large government sponsored space programs can benefit from small space companies, acting as catalysts for quick results.

To quote president Lincoln, "Government should do for the people what they cannot do better for themselves", and laying down the framework for large space projects, like other public works for the common good, fall under this category. Large space infrastructure development projects cannot be initiated or created by private investors alone. Space solar power or orbital debris mitigation, fuel depots or interplanetary missions or even large space based observatories, all remain the domain of NASA and the government. However, building components and servicing these large systems, once put in place, could be a healthy sector for private space company participation.

The International Space Station(ISS) could be better managed by a separate organization modeled after the old Intelsat structure or similar, and space companies, especially these small and agile ones that produce at very high efficiency should be nurtured to support ISS operations, relieving NASA to accelerate the agency's cutting-edge goals. The role of the Dept. of Space must be one of coordination between government, international and private space activity, allowing NASA to better focus on the agency's unique pioneering exploration charter. Should the 21<sup>st</sup> century creation and maintenance of National Security Infrastructure depend on DoD obsolete practices and a few established sole source suppliers, or should it be spread out over a much larger and more competitive commercial sector including small business? If government civil jobs protection is the goal, then we might stay with status quo(though it appears clearly unsustainable), but if true jobs expansion is what we seek, then we might want a much more vigorous overhaul that includes private sector at the core of all formulation plans. Put into effect under the former Secretary of Defense, Robert Gates, it is good to see that this transition is already in progress, reshaping procurement and administration procedures, across all DoD units.

Human space activity remains a special arena of human endeavor that is able to bring the finest minds of diverse friendly nations together in peaceful projects of progressive development. Spacefaring nations that once aimed their nuclear arsenals at each other have now joined forces to support the buildup and operations of International space Station.

The next stage in this development is handing over the reins to global commerce and economic development. It is good to see this happening as private space companies like Blue Origin and Virgin Galactic prepare their suborbital vehicles to jump start space tourism, and SpaceX and Orbital Sciences start to service the global space infrastructure, starting with the ISS. It is good to see that a SpaceX vehicle just docked the Bigelow Expandable Activity Module to the ISS and that larger modules are planned.

We might do well to pay attention to the fact that eight minutes into flight, space travel puts people in a global regime, that upsets twentieth century political dogma and Machiavellian statecraft, and pushes us think as a truly globally connected species. Human space activity exemplifies Cosmopolitanism, the philosophy that holds all people everywhere share the same values while respecting cultural differences and accepting plurality. Facing global problems, both man-made and natural, of unprecedented proportions, we are truly blessed to be able to shape our destiny with timely progress in technologies that are at the core of human space activity.

Space remains the ultimate frontier, especially for those resilient economies, even during this downturn. Among all spacefaring nations today, the US constitution, that resonates with the freedom of Man, is the best suited for expanding space related activities. Can US space policy be reshaped to encompass a globally inclusive, civilian, cosmopolitan paradigm? Can the US shepherd the spacefaring nations of the world in undertaking visionary space infrastructure development projects to tackle global threats with large programs like planetary defense and orbital debris mitigation or monitoring pollution or climate change?

In this election year, rather than wait till the last minute to use NASA and space activity as one more item or hook on the debate agenda, it would be good to hear the views of the candidates and how they intend to articulate space activity, especially about nurturing the growth of an entirely new, innovative and homegrown private space industry. Despite the actions of these last few years by a polarized US Congress willing to self-inflict wounds even as a fragile global economy tries to recover,

there are a few silver linings to the dark clouds on the horizon. One such arena of common pride among the leadership is NASA and space activity.

Though the gut reaction to creating a department of Space, especially among the hard space technology community, is one of not wanting to deal with another level of administration and more layers of bureaucracy, good governance is a prerequisite for a vibrant economy and for any progressive technological society. The US government, evolved from other great democracies, has the mechanisms to accelerate advanced technologies for the benefit of all humanity, and has proved its mettle, time and again, over the years. When the growth of an advanced technology industry arrives at certain levels of maturity and complexity, as it has for space activity, especially in the private sector, a department and a cabinet level secretary can enhance all the organizations involved. Private, public and international space projects can be accomplished quickly and safely if such a department is created.

Vision is the stuff that shapes the destiny of societies, just as commerce is the lifeblood that drives it. Space activity has always been associated with progressive vision in modern society. Our leaders use it to excite the public and garner support in their constituencies. A department of Space would help inspire the next generation of space explorers and set them on a path of discovery and open up new opportunities.

Is it too much to ask of the wealthiest nation on Earth that charts new territories and seeks new opportunities for economic growth for all the free world? Is \$60B in a \$4T budget outlay to create and run a new and visionary department with a charter to take the reins of an emerging high technology industry that is homegrown, and to align it with the spacefaring world's growing ambitions to return to the Moon, go to Mars, harvest solar energy from space, or mine the asteroids out of synch with other ambitions? Is it not prudent to seek alignment among nations to propose a sturdy global planetary defense network as the world population grows and new cities are built around the globe?

Can some projects now within the various other departments and agencies including NASA benefit from such a new Department of Space? Does all of it have to be discretionary spending? Could other departments share some of the costs of creating such a forward-looking department? Might the world's spacefaring nations pitch in? Climate change has built strong global coalitions in the past few years. Should we not invest on par with such activity for our future? Could this be a profitable endeavor with rapid rewards, waiting in the wing, for our nation and for the whole world? These are some of the questions our aspiring presidential candidates might debate, perhaps?

Departments are created, dismantled, merged or transformed as new needs arise and the complexity is perceived to overwhelm the capacity of any one organization or agency. New departments work across agencies with seemingly disparate charters to facilitate action in catalytic ways. Homeland Security department was created swiftly after the 9/11 terrorist attack to coordinate activity between agencies, and an industry has grown under it. The biotech industry has had great benefits from the Health and Human Services Department and CDC agency for swift and effective results for stamping out pandemics. It shows that departments can be quick to coordinate agile action among various US and international agencies.

The zero sum game we pursue on Earth dictates the kind of politics our leaders manipulate and exude. By breaking out into the space and using abundant resources there, humanity can quickly ascend the current strife for resources and create a far richer experience, abandoning the pathological limitations of our species on terra firma, realizing our true potential as Homo Sapiens Cosmicus.

As the established spacefaring nations start combining efforts with emerging space powers to plan and execute missions to the Moon, Mars and beyond, the creation of a US Dept. of Space might help the US administration to synergetically combine the energies of both the government space programs of the world and coordinate the various private space projects as well as assist the globe of nations in peaceful collaboration through the pursuit of excellence in progressive, peaceful space activities. A US department of Space would also help spur the US space industry, a truly 21<sup>st</sup> century endeavor. ##

Readers might like to look over USC team project titled "The US Department of Space" here [http://denecs.usc.edu/hosted/ASTE/527\\_20111/](http://denecs.usc.edu/hosted/ASTE/527_20111/)

The proceedings may be accessed here : <https://vimeo.com/33937720?ref=tw-share>

Madhu Thangavelu conducts the ASTE527 Graduate Space Concepts Synthesis Studio in the Department of Astronautical Engineering within the Viterbi School of Engineering and is a graduate thesis adviser in the School of Architecture at the Univ. of Southern California in Los Angeles. ##

## New Challenges in Space For the Next President of United States: The United States and Its International and Commercial Partners can Reshape Federal Space Priorities

28 June, 2016 – by **Dave Dunlop**. Chair NSS International Committee

As we approach the 50th Anniversary of the Apollo 11 Landing in 2019, we recall the audacity of that peaceful competition initiative in a time of intense cold war politics and envision similarly bold new initiatives which best utilize the strengths of NASA and other US Federal Agencies and the global partners of the United States. Whereas exploration of the Moon was the stretch goal at the beginning of the 1960s we are in a very different position today.

**We went to the Moon** in the 1960's and 70's with both robots and people and announced that "we came in peace for all mankind," but found that "footprints and flags" program unsustainable politically. At a million dollars a minute for astronaut time on the lunar surface this was also unsustainable economically. (1)

### Post Apollo Space Program Triumphs Since Apollo

- 1 Since then we have replaced the intensity of the cold war in space with the breakthrough Apollo-Soyuz mission and subsequently the much broader diplomatic triumph of international cooperation by operating the Space Shuttle building the International Space Station with International partners and learning to routinely live and work in orbit.
- 2 We have sent probes to complete the fly-bys of all the major planets that we have thus far observed in our solar system.
- 3 A fleet of orbiters is studying Mars and a cadence of internationally supported exploration missions is building the understanding needed for human exploration and presence on the Red Planet.
- 4 We have designed and launched a series of great orbital observatories beginning with the Hubble telescope that have transformed our understanding of the universe.
- 5 We are collaborating with 15 international partners coordinating our activities in a big picture Global Exploration Roadmap
- 6 We have made major breakthroughs in lowering the costs of launching things into space using public private partnerships in a commercial cargo crew programs and that presents us with the dual challenges of the present:

### Current Challenges

These achievements have prepared us for a more audacious, and far larger challenges, (as formidable as the Moon Race of the 1960's). We now face the global challenges of The Near Frontier and The Far Frontier.

### I The Near Frontier

The first challenge, the Near Frontier is to expand permanent human presence and the human ecosphere beyond the Geostationary orbit of Earth to both the Moon then Mars using the newly affordable technologies and new scientific understanding of these bodies.(2) In a largely parallel effort humans can advance permanent presence to both bodies.

- A We can go beyond LEO and the challenges of beginning exploration by building an infrastructure in cislunar space. That infrastructure will enable our advance to both the Moon and Mars and also prepare for the expansion Earth's economy's to address the formidable problems of creating an environmentally sustainable civilization on Earth.
- B The needs of the expanding population of Earth can be provided through peaceful economic collaboration and development of new space based resources for clean energy and mineral resources and the construction of a sustainable economy. We must begin to use the resources available in space on the surface of the Moon and in Near Earth Asteroidal Resources.  
We can extend that initiative to human presence and utilization of the Mars system. An integrated program to advance to both destination can be developed during the next decade.  
The significance and relevance of the Near Frontier is driven by environmental necessity and the threats of socio-political and environmental instability as primary drivers if we do not act decisively. These political priorities will also support the scientific rationale of continued exploration.

C Only the development of space based resources can be sufficient to meet the challenges for a hopeful human and environmental future and this must be done by people living and working in space. We believe that this transformation will be increasingly lead by commercial initiatives centered on:

**The industrialization of space:**

**A The production of fuels in space,**

Both new entrepreneurial companies such as Deep Space Industries, Moon-X, Planetary Resources, Shackleton Energy, and heritage companies such as Boeing and ULA, and new collaborative initiatives such as the Hague Space Resources Governance Working Group are focused on the beginning challenges of this economic frontier.

**B The expansion of universal and global communications networks,**

The expansion of the internet to a universal global utility is being pursued by companies such One Web, Space-X and this will have a transformative impact on all of humanity and provide a means to expand the human potential of the global economy.

**C Space tourism,**

Companies such as Bigelow, Blue Origin, Boeing, Space-X, and Virgin Galactic, and World View are opening opportunities for more massive participation in new research and economic activities in space.

**International Collaboration in the Development of Space Based Clean Energy**

The US DOE and its National Lab system must be integrated into this program as both a national initiative for the US as well as an initiative with international partners).

A **Space solar power** must be a collaborative initiative for the US, India, Japan, China, EU, Russian, and the G-20. NSS is the premier NGO leader in promotion and collaboration with its Kalam initiatives, Chinese and IAA connections, and International SunSat competition with Space Canada and Ohio University, and public outreach by Celestial Mechanics)

**B The Development of Commercial Fusion Power**

The ITER program other approaches flowing from CERN and other labs must pursue to promise of commercial fusion reactors. This can address both the critical demands for clean energy on Earth as well as open the realm of deep space for human presence and economic activity.

C The use of Americium RTGs (with a half life of 470 years) can provide a rationale for:

- 1 Centrally reprocessing stored fission reactor wastes around the US and elsewhere,
- 2 Cleaning up stored wastes from fission plants, and
- 3 Using these materials for long duration power requirements for deep space missions planned for the Far Frontier.

The US and its international and commercial partners must settle the Near Frontier and provide the directed global investments for these global requirements!

NASA's Human Exploration and Operations Mission Directorate HEOMD can address the Near Frontier, acting in closer concert with our International and commercial partners. We have witnessed the effectiveness of NASA's Public Private Partnership model in making transformative changes for commercial cargo and crew program. The framework of NASA's participation in the International Space Exploration Coordination Group is a mechanism to define an extension of the foundation of Treaty partnerships begun with the ISS.

Public Private Partnerships has made efficient use of both public and private resources and we must expand that model with our international and commercial partners. This endeavor will also more broadly engage other Federal Agencies such as Transportation and Commerce and the Department of State and the DOE and justify a Cabinet level Space Council.

We must defend our existence in the inner solar system by pursuing the development of the Near Frontier together as a global community expanding our presence and economy to both the Moon and Mars and the asteroids of the inner solar system. The theme of the human settlement of space is the province of the Near Frontier for the next great era of the Space Age. Human-robotic collaboration will be the hallmark of this advance of humanity as tele-robotic presence from orbit is followed by physical human and robotic presence on the surface of both the Moon and Mars and other asteroidal destinations.

Our operations in the New Frontier must provide and **expand a comprehensive program of planetary protection** so that our species is not caught with the strategic surprise of an extinction level impacts. This is another collaborative dimension of a global space endeavor that can likely reduce risks and shares costs with a genuine global defense that collaboratively engage the military space resources of global space faring nations in improved situational awareness and security requirements. The US DOD is a key leader in this international arena. The establishment of NASA's Office of Planetary Protection is a good foundation for this objective. The NEOCAM Discovery Mission Proposal is another opportunity that must be funded. The USAF

Space Surveillance Network and multi-lateral agreements with international partners are additional foundational assets.

### **Transformational Commercial Activities**

The commercial sector will transform access to space, which is now expensive and exotic and government provided to what is affordable, routine and commercially provided to both government and private customers.

- A Our International Space Station is an early target for commercial evolution and public private partnerships that involve our ISS Treaty partners.
- B New space stations from Russia, China, and commercial collaborations will also expand the infrastructures in Low Earth Orbit. The development of Chinese Space Station will begin before the end of this decade and be completed by the middle of the next. US Russian tensions may well lead to the Russian Space station breakout from the ISS and the reestablishment of Russian independent capabilities. Bigelow has also outline plans for Commercial space station initiatives. The proliferation of these operations in LEO are also part of the infrastructure supporting future economic growth in space.
- C An Earth-Moon Lagrange Gateway station will create a hub for access to the Lunar Surface, Mars missions, deep space missions, and the asteroids. Telerobotic presence and operations from this station will provide affordable development of the lunar surface for further exploration bases and resources. An early extended duration initiative is similar in scope & cost to a Low Cost Lunar Base which is an estimated \$10B project)
- D An early International Lunar Base can be developed for an order of magnitude less expense than the ISS project for an estimated \$ 10B (5). This can mature (as the model of Antarctica has shown) in more substantial research facilities.

Early trade studies would suggest that **all of these objectives are economically feasible by the end of the 2020's with collaborative international and commercial investments.**

II **The Far Frontier** is the distant Kuiper belt and the Oort cloud realm of comets. The New Frontier Mission's spectacular flyby of Pluto and its extended mission to observe yet more distant Kuiper Belt Objects have provided our first peek of astounding discoveries and surprises in this distant region. Only the prior Pioneer and Voyager missions have penetrated these depths but their passage left many mysteries. Kuiper's Frontier was once the realm of theory but now has been populated by the discovery of many substantial Kuiper Belt Objects. These newly classified minor planets, and new insights into the history of the solar system and the effects of the movement of the gas planets challenge our understanding of the early solar system.

The Far Frontier defines the most advanced scientific and engineering requirements of our generation and demands new innovations as well as extended international partnerships to share the risks, costs, benefits and excitement of distant exploration into interstellar space. The detection of many significant smaller bodies (and hints of perhaps more massive ones yet unobserved in the farthest reaches of our own solar system) provide for new surprises. This far frontier is also psychologically important as a unifying framework and direction for human culture and the requirements for extended international collaboration for the future.

We can accept the challenges of exploration of the Far Frontier as a shared challenge for human science and engineering and the extension of new tools and capabilities into the realm of the unknown depths of our own solar system.

- A NASA as a contributing member of the mechanism of the International Space Exploration Coordination Group (ISECG) and COSPAR could support an International Far Frontier Conference, A collaboration of space advocacy organization such as NSS, the X-Prize Foundation, The Space Frontier Foundation,

and The Heinlein Trust might addressing the challenges of the exploration of the Kuiper Belt and Oort Cloud. Similarly the NASA Institute of Advanced Concepts (NIAC) could be an appropriate vehicle as well as the aforementioned private organizations.

B This can express proposed efforts to address the Far Frontier in an expanded **Global Exploration Roadmap** (GER) which now principally describes activities concerned with the Near Frontier. A roadmap for exploration of this region could be one early result. Another product could be a technology development roadmap meeting the challenges of such exploration.

NASA's pioneering role in exploration and the grand tradition of achievements of the Science Mission Directorate can continue by setting goals for proposals and the recommendations of NASA advisory groups. The role of the Space Technology Mission Directorate and the NASA Institute of Advanced Concepts are also critical in the development of game changing technologies and enabling economic approaches to the Far Frontier.

### III The Middle Frontier as a new Proving Ground

The focus on the Far Frontier will also advance our efforts to explore and understand the realm of the Gas Planets, our Middle Frontier.

- A An expanding global economy and partnerships in space will support initiatives and advances in our knowledge of these largest planets in our solar system and their numerous moons.
- B Perhaps we can determine whether life has evolved in the ocean worlds we find on cryogenic moons or with exotic cryo-chemistries that differ from those that are familiar from life on Earth.
- C This realm, much closer to us than the Far Frontier, nevertheless can provide the proving ground for tools and systems that must function so much farther out.
- D (The Middle Frontier can take advantage of the cryo-environments in our Moon's polar regions in the Near Frontier as an additional proving ground in the Near frontier).
- E NASA must also provide resources for the Space Technology Directorate to support and demonstrate new technology requirements of scientific exploration and autonomous operations at those distances.
- F The Science Mission Directorate must be less risk averse and willing to support such demonstrations of new technologies as part of mission development requirements. The billion dollar platforms destined for the New Frontier class missions must therefore support innovative approaches not just proven heritage systems. Only through experimental demonstrations will technology innovations advance our capabilities.

### New NASA Priorities

The National Space Society has from its beginning believed that humanity's destiny was beyond the Earth, living and working in space and moving outward from our ancestral planet. That new legislative charter for NASA is the most important priority in developing the Near Frontier. This is "the rising tide that will lift all boats" on our crowded, environmentally stressed planet and our industrial civilization which is operating unsustainably at present beyond its own carrying capacity and resource limits.

- A Human settlement will break these constraints both on Earth and permit positive transformational and sustainable development of the Near Frontier. That must define NASA's priorities moving forward.
- B As a space foreign policy initiative we can encourage an International Lunar Decade that enlists broader voluntary international engagement the all G-20 group nations and many nations that also have advanced technology and strong economies. This approach was most successful at the beginning of the Space Age as the IGY demonstrated and still a model for the present.
- C We must welcome and encourage all countries to participate (even those most economically challenged) and make sure that educational opportunities and market driven distribution of space services and goods are provided and accessible everywhere on Earth. We must replace the stagnate and stalemated Moon Treaty (unratified by the major space faring powers) with one that recognizes individual and commercial property right in space and nurtures rather than inhibits development. Multi-lateral working agreements can provide a collaborative path forward.
- D **NASA's resources are not sufficient to undertake this challenge alone.** Global Challenges must be met with global resources and an economic model that encompasses the realities of global economic requirements. The International Lunar Decade Campaign is intended to serve that economic and political reality.

- 1 We are encouraged by ESA's step forward in advocacy and support for an International Moon Base/Moon Village.
- 2 We also note that many of NASA's partners in the International Space Exploration Coordination Group have also set the Moon as a strategic priority and that these international trends support the priority of the Near Frontier for NASA as well (and a better integrated and balanced Moon to Mars program trajectory).
- 3 Private capital must be enlisted to effect the massive transformations and development required and the expansion of international public private partnerships will be a strategic key to increasing the pace and scope of the infrastructure of cislunar development. This factor will become even more dynamic as a driver of international collaboration. Today the commercial satellite industry amounts to some \$250 Billion dollars annually, more than 10 times NASA's budget, and that imbalance is likely to grow as new industries such as space tourism, space mining and fuel production and distribution, advanced global communications expansion, and space manufacturing are developed and the new cislunar economy develops geometric growth.
- 4 There is the potential for significant amounts of space debris to become the feedstocks for space manufacturing and the development of advanced facilities in GEO, and in cislunar space. Cleaning up space debris, improving global situational awareness, protecting existing infrastructure, and expanding access to space are the key requirement for both commercial and international partnerships.
- 5 A growing cislunar economy will demand a more global infrastructure of spaceports and support facilities that remind us of the development of international commercial aviation. In the US this will increase the significance of the Aerospace States Association and of investment role in such new facilities by both state governments and commercial providers.
- 6 It will also demand broad regulatory coordination for the international community and the mechanisms established by International organizations such as the ITU, COSPAR, UN COPUOS. The DOT and FAA will play a leadership role in these domestic regulatory initiatives with US industry and international space partnerships and collaborators. NASA's experience with international partners is extensive and it has provided leadership both working collaboratively on the International Space Station and the Solar System Exploration Virtual Research Institute network of international partners, and ISECG.

### Summary

The next US President has an opportunity to reshape and reenergize US space policies across the spectrum of Federal agencies and to provide bold leadership in the international and commercial realms in the best peaceful tradition of the US Apollo program and the US-Soviet cold war competition. Our message in addressing the New Challenges of the Near and Far Frontiers of space is: "We Come in Peace With All Mankind." DD

### Moon? Mars? Asteroids? All? In what sequence?



**What sequence is the most logical in terms of technology?  
In terms of cost? In terms of payback? In terms of preparedness?**

## What Happens When the Sky Starts to Fall?

By Kim Peart

A flake of paint blowing in the wind will do no harm on Earth, even if it hits the windscreen of a speeding car. In space, where there is no air, a flake of paint flying at 34,500 km/h is in a whole different ball park. When a window of the Capola observation deck on the International Space Station was cracked recently, it was believed to be the result of a flake of paint in space moving at high velocity. If a flake of paint could do that much damage, imagine what a lost nut would do?

A flake of paint hitting a military satellite at that speed could take it out and if the incident were to be misunderstood and reacted to, could easily lead to unexpected war on Earth, and in space, beginning with the destruction of enemy satellites. There are over a trillion dollars worth of satellites whizzing around above Earth and a great many dead satellites, as well as a huge volume of space junk of all sizes, from discarded rockets to flakes of paint.

Satellites are in many ways the invisible face of modern society, providing weather information, environmental monitoring, communications, navigation with GPS, internet services and more. [1] Without satellites, we would have little or no warning about many severe weather events.

Seeking to pursue space development for science and profit at minimal cost, little thought has been given to the need to keep space clean. It is estimated that there are 170 million pieces of space junk in orbit around Earth, including 30,000 pieces of debris larger than a football. [2]

Every rocket flying into space must now dodge space junk and from time to time the International Space Station must be moved to avoid a piece of high velocity space debris. With more satellites being sent into space all the time, the volume of objects above Earth is constantly increasing.

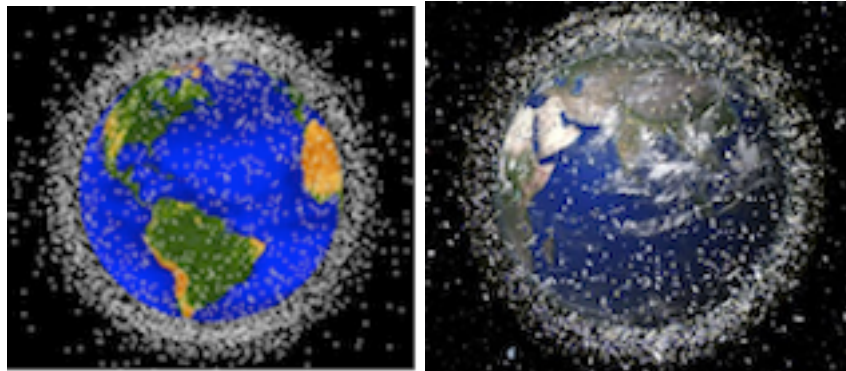

### A SPACE JUNK AVALANCHE

The 2013 hit SF movie 'Gravity' brought to the attention of the World a problem that most people had no idea about, where all satellites and space stations above Earth were wiped out in an avalanche of high velocity space junk. The potential for this happening was first identified by Donald J. Kessler in 1979 and subsequently became known as the Kessler Syndrome. [3]

With such a high volume of working space stations, live satellites, dead satellites and space junk flying around above Earth, Kessler feared that a moment in time would arrive when a satellite was destroyed, sending high velocity debris into other satellites, causing an avalanche of space junk that quickly destroys all satellites and space stations, leaving a maelstrom of high velocity debris to rule the stars.

The sky would be brilliant on a clear night, as space junk came roaring in through the air, and often reached the ground. With a trillion dollars worth of satellites suddenly plummeting to zero value, we can but imagine the economic impact of this event on Earth.

If all satellites can be lost, we can also wonder about the safety of air travel, as space junk flying in hits too many aircraft, making flights too dangerous. **We could be grounded.**

In February a man in India was killed by an object from space, believed to be a meteorite. [4]

This is the first recorded instance in history of anyone being killed by an object from space. If a space junk avalanche happens, we may all be left wondering if we will get hit by a piece of space junk.

The Australian Government takes the space junk problem quite seriously, investing \$150 million to monitor and bring down to Earth dead satellites and space debris. [5]



Dr Ben Greene, the head of the Space Environment Centre at Mt Stromlo, near Canberra, recently declared, "The most pessimistic mathematical model says that we are within five years of having a 50–50 chance that a catastrophic avalanche of collisions will occur any day. The most optimistic model says we've got 25 years." [6]

Are we prepared to accept that we now live with a problem that could strike any day within the next 25 years? A maelstrom of space junk above Earth would make it impossible to pursue space exploration or development for hundreds of years, until a critical volume of space debris had fallen to Earth.

All by itself, a space junk avalanche could bring human civilization crashing down and we can have no idea if we will survive the experience, or be able to put the pieces back together again. Blinded, it is too possible that nuclear armed powers could panic in fear of invasion and unleash nuclear madness, which could herald the end of all life on Earth. With or without nuclear war, what follows may be an apocalypse, as human society collapses into savagery. The psychological impact alone would deflate the human spirit. So much would be lost so swiftly. So many dreams smashed.

### **THE TRIGGER FOR A SPACE JUNK AVALANCHE**

With tensions on Earth mounting over Ukraine and the South China Sea, we are living with a powder keg on Earth that has a very short fuse. Should some accident or misunderstanding tumble into conflict and war goes global, one of the first targets to be hit will be military satellites, to blind the eyes in the sky of the enemy. If this happens, it could be the trigger for a space junk avalanche that takes out all satellites. The space junk avalanche could also be caused by a small asteroid flying close to Earth and hitting a satellite.

### **A RACE AGAINST TIME**

Faced with an impossible challenge, in addition to many other problems that we now face on Earth, including a carbon crisis, it is pretty hard to imagine what can be done to save human civilization and avoid the nuclear madness that may follow a space junk avalanche. We need to clean up space, but we also need to ensure that we have a future in space, to keep the human spirit alive with hope.

If we could establish a sustainable industrial presence beyond the space junk zone, which could be in the orbit of the Moon, we would keep the space dream alive and also be able to deal with the space junk problem from above. A sustainable industrial presence beyond Earth is when there is no further need for resources or investment from Earth, which would be achieved by using power generated with the Sun to process resources gained from near Earth asteroids, from the Moon and later from Mars and the Asteroid Belt. It would be highly expensive to establish a sustainable industrial presence beyond Earth at a human scale, but if there is a will to act, this could happen.

An alternative approach would be to invest in a mini robot space program, aimed at establishing a sustainable industrial presence beyond Earth, at a mini robot scale. This approach would achieve the aim at a fraction of the cost of a human scale project and be delivered so much faster. Once a mini robot industrial presence is built beyond Earth, mini robots can be used to build human scale environments. A mini robot space program would be largely automated, managed by AIs in space and directed from Earth using remote control systems. Virtual reality headsets, like the Oculus Rift, could be used to see through the eyes of a robot in space and work with the robot hands.

With the clock ticking against us, we have no time to waste.

### **BENEFITS OF SUCCESS**

By keeping hope alive with a sustainable industrial presence beyond Earth, we can keep the human spirit alive on Earth, with hope for a future among the stars, make any product for Earth markets, build human habitats in orbital space settlements anywhere in the Solar System, create a stellar economy, built on the power of the Sun, where there will be no limit to growth, have direct access to the level of power needed to win back a safe Earth from the carbon crisis and be able to explore the stars.

### **ACHIEVING THE IMPOSSIBLE**

If we wish to assure our survival, we have no choice but to take on the impossible, rally the numbers needed and invest in the work to build a sustainable industrial presence beyond Earth. If Dr Greene is correct, then the space junk avalanche will strike any day within the next 25 years, and that is one hell of a scarifying prediction.

### **What can we do?**

- We can use the technology we have and direct our energies toward building a future that has a future.

- We can connect globally in the virtual worlds, to plan local action and build working models of the future we plan in space. In the virtual world robots can be trained toward using robots in space, especially via remote control systems.
- We can work as individuals and in teams to develop working parts of a sustainable industrial presence beyond Earth.

The way is open, if we wish to kick the door open and get to work.

### **SPACE PIONEERS IN ROSS**

Our small space development enterprise, Space Pioneers, is located in Ross in the rural heart of Tasmania. From Ross we can reach out to the world and using the virtual worlds, we can hold meetings anywhere on Earth where there is an Internet connection. We own land in Ross, where we plan to develop the hands-on aspects of the mini robot space program. We welcome collaboration, should anyone like to join us in Ross.

We are looking to create paid work with this project, which will happen as funding is secured. Anyone on Earth, who values survival, can connect with Space Pioneers via the virtual worlds.

### **SPACE DEBRIS APOCALYPSE SURVIVAL CHALLENGE**

To assure our survival beyond a predicted space junk avalanche, we need to secure a sustainable industrial presence beyond Earth. We also need to maximise all efforts to clean up space junk, so that we will avoid a space junk avalanche happening, if we can.

We call on all individuals and organisations on Earth to rise to the challenge of solving the space junk problem and assuring human survival, by working on the mini robot space program, as individuals, or in teams. We can look toward prizes being established for each phase of the project, from virtual world activities to an industrial presence in space.

With so much at stake, can there be any greater challenge on Earth?

### **SPIN-OFF BENEFITS**

The greatest prize of all will benefit all Earth's children, when we create a stellar economy that sends poverty into history. We can start designing the shape of the stellar economy now. An economy free of poverty will improve the prospects for peace on Earth, which will also improve the security environment in space. We can also design the shape of a sustainable human presence on Earth, which will become possible with industry shifting into space.

### **What will a sustainable human presence on Earth look like?**

- There may be a slow Earth movement, where container ships and jet planes are replaced by airships, able to reach any location on Earth.
- The needs of evolution and the size of each person's environmental footprint, will determine how many people can live a good life on our home planet.
- Creating land beyond Earth in orbital space settlements will make a place for people to go in greater number than ever lived on Earth.
- We will have the power of the Sun to deal with the carbon crisis, to extract excess carbon from the air and process extracted carbon into a useful resource.
- We will be able to build an adjustable sunshade in space, to keep the Earth cool. We will be able to build a sunshade above Venus, as the first step toward transforming second rock into a second Earth.

### **The second step would be the extraction of carbon from the Venusian air.**

We have all to gain by reaching to the stars, and all to lose on Earth, if we ignore the basic demands of survival.

### **PREPARING FOR THE WORST**

As we strive for a better future on Earth and in space, we can also prepare for the worst that may happen to our world. If the space junk avalanche strikes, before a sustainable industrial presence beyond Earth is established, we will need to look to our survival instinct.

- We can gather together the knowledge of rebuilding space technology and look toward a time when we can reach beyond Earth again. There may be many survival communities around the Earth, where the knowledge of rebuilding a space program is preserved.
- We can keep our society going on Earth, using the same approach with mini robots that we would use in space.
- We can also work on ways to break through the space junk maelstrom above our heads, secure space beyond Earth and deal with high velocity space junk from above, as well as from Earth.

- It may be possible to develop some form of shield, to punch through the space junk maelstrom.

It will be catastrophic if the global economy collapses and nations panic as chaos rises around them. Should nuclear madness be unleashed and the planet gripped by a nuclear winter, we will need to plan to survive that. We will have our work cut out for us, like any society that must meet the demands of survival in a difficult environment. We may find that we must learn to live on Earth as if we were living in space.

### HOPING FOR THE BEST

If time is with us, we may stand a good chance of securing a sustainable industrial presence beyond Earth, before a space junk avalanche hijacks our future.

At the same time, we can maximise all efforts to clean up space.

Acknowledging the space junk problem, many satellites are now being designed to return to Earth at the end of their working life, to burn in the air, or land in the sea. But a satellite that dies, and many do, cannot be controlled or returned to Earth. At times even working satellites crash into each other. The spacefaring nations have pursued space development on the cheap, blithely blind to the need to keep space clean.

We must now look to a new era of space development, where space will be kept clean. The most cost-effective way to achieve this, is to establish a sustainable industrial presence beyond Earth and beyond the space junk zone. If we can achieve this with mini robots, it will happen faster, sooner and cheaper than is possible with a human scale space program. And mini robots can press on to build human scale space habitats and the shuttle craft that return to Earth to collect passengers.

We can look toward the day when we, or our children, will watch the Earth from space in the deck of an orbital space settlement. All ideas begin as a thought and some ideas are quite bold, like the decision to go to the Moon when the space age had just begun. **Now we are told that the space age could end, any day, so we will need to be bold, to reach for the stars.**

### REFERENCES ~

- [1] What Are Satellites Used For? Union of Concerned Scientists  
[http://www.ucsusa.org/nuclear-weapons/space-weapons/what-are-satellites-used-for#.V2eNL1eA\\_8s](http://www.ucsusa.org/nuclear-weapons/space-weapons/what-are-satellites-used-for#.V2eNL1eA_8s)
- [2] Astronomers meet in Canberra to tackle problem of man-made 'space junk'  
James Fettes, 31 May 2016, ABC News Online  
[www.abc.net.au/news/2016-05-31/space-junk-collision-a-growing-threat-for-satellites/7463520](http://www.abc.net.au/news/2016-05-31/space-junk-collision-a-growing-threat-for-satellites/7463520)
- [3] Kessler syndrome Wikipedia  
[https://en.wikipedia.org/wiki/Kessler\\_syndrome](https://en.wikipedia.org/wiki/Kessler_syndrome)
- [4] Did a meteorite kill a man in India? Soutik Biswas, 10 February 2016, BBC News  
<http://www.bbc.com/news/world-asia-india-35538484>
- [5] New Australian research centre to remove space junk, save satellites and spacecraft – Carl Smith and Chris Kimball, 11 Mar 2014, ABC News Online  
<http://www.abc.net.au/news/2014-03-07/new-research-centre-to-remove-space-junk-save-satellites/5306286>
- [6] 'Catastrophic avalanche' of space junk could wipe out satellites within years – Brodie Smith, 31 May 2016, Sydney Morning Herald  
<http://www.smh.com.au/technology/sci-tech/catastrophic-avalanche-of-space-junk-could-wipe-out-satellites-within-years-20160531-gp8415.html>

### ABOUT KIM PEART

Kim Peart was raised in Howrah from 1952, when there were farms there. Finding adventure in Scouts and Army Cadets, Kim later pursued art and founded a Viking Society in Tasmania in 1975, pursuing history and culture. In 1976 Kim saw an ad for space settlement and signed up to be a space development advocate. Environmental matters came later and figuring out how we can live in harmony with Nature. Earth matters and space issues merged in 2006 when Kim wrote his document ~ Creating A Solar Civilization ~ exploring how we can only achieve a sustainable human presence on Earth, by building a sustainable industrial presence beyond Earth. Kim now lives in Ross with his wife, Jennifer, where an interest is taken in the Ross Bridge and other history, as well as a local space project on our land and using the virtual worlds to connect globally with like-minded people, to plan local action toward creating a celestial future and winning back a safe Earth. The adventure has only just begun. ##

Past TTSIQ issues are online at: [www.moonsociety.org/international/ttsiq/](http://www.moonsociety.org/international/ttsiq/) and at: [www.nss.org/tothestars/](http://www.nss.org/tothestars/)

**ONLINE OP-ED ARTICLES FROM OTHER WRITERS WORTH READING****Federal legislation to jumpstart Space Solar Power**

<http://www.thespacereview.com/article/2956/11> By Mike Snead

**The challenges of commercializing research in low Earth orbit**

<http://www.thespacereview.com/article/2958/1> by Jeff Foust

**Moon Mosaics: Groundbreaking Science Images of Stunning Lunar Science**

[www.space.com/32559-moon-image-mosaics-reveal-incredible-detail-of-lunar-surface.html](http://www.space.com/32559-moon-image-mosaics-reveal-incredible-detail-of-lunar-surface.html)

By Mark Robinson

**Advice from a Moonwalker: Buzz Aldrin Shares Life Lessons in New Book**

[www.space.com/32585-buzz-aldrin-book-no-dream-is-too-high.html](http://www.space.com/32585-buzz-aldrin-book-no-dream-is-too-high.html) – By Buzz Aldrin

**A Long, Prosperous Life: Leonard Nimoy Remembered in New Film**

[www.space.com/32598-for-the-love-of-spock-nimoy-documentary.html](http://www.space.com/32598-for-the-love-of-spock-nimoy-documentary.html) – By Elizabeth Howell

**Expanding the Space Station Market**

<http://www.thespacereview.com/article/2967/1> – By Jeff Foust

“Inflatables make you think of things like balloons that don’t have a structure in and of themselves, that’s why we prefer the term “expandable”.

**ESA’s Guide to the Moon**

[www.esa.int/Our\\_Activities/Human\\_Spaceflight/ESA\\_s\\_guide\\_to\\_the\\_Moon](http://www.esa.int/Our_Activities/Human_Spaceflight/ESA_s_guide_to_the_Moon)

What have scientists learnt about the Moon since the first probe in 1959 and the Apollo lunar landing 10 years later? What questions are unanswered and what is the future of lunar exploration?

**A US Department of Space?**

[www.spacedaily.com/reports/A\\_US\\_Department\\_of\\_Space\\_999.html](http://www.spacedaily.com/reports/A_US_Department_of_Space_999.html) – by Madhu Thangavelu

**A launch company, and industry, in transformation**

<http://www.thespacereview.com/article/2971/1> = by Jeff Foust

**Book Review: The Value of the Moon – by Paul Spudis**

<http://www.thespacereview.com/article/2968/1> – by Jeff Foust

**The US should challenge the EU to lead lunar development**

[www.thespacereview.com/article/2973/1](http://www.thespacereview.com/article/2973/1) – by Vidvuds Beldavs

**Time for fresh thinking about collaboration in space**

<http://www.thespacereview.com/article/2976/1> – by Ajey Lele

**Will SpaceX Get People to Mars Before NASA?**

[www.space.com/32773-will-spacex-get-people-to-mars-before-nasa.html](http://www.space.com/32773-will-spacex-get-people-to-mars-before-nasa.html) – by Irene Klotz

## The future of Space Economics and Settlement

<http://www.thespacereview.com/article/2978/1> – by Dick Eagleson

## Is the Moon Our Ticket to the Solar System? Q&A with Author Paul D. Spudis

[www.space.com/32798-going-back-to-the-moon-q-a-paul-spudis.html](http://www.space.com/32798-going-back-to-the-moon-q-a-paul-spudis.html)

## When CubeSats are too big

[www.thespacereview.com/article/2984/1](http://www.thespacereview.com/article/2984/1) = by Jeff Foust

## The challenges of commercializing Fly me to the Moon (Astobiotics Lunar X-Prize entry)

[www.thespacereview.com/article/3006/1](http://www.thespacereview.com/article/3006/1) By Dwayne Day



Story above

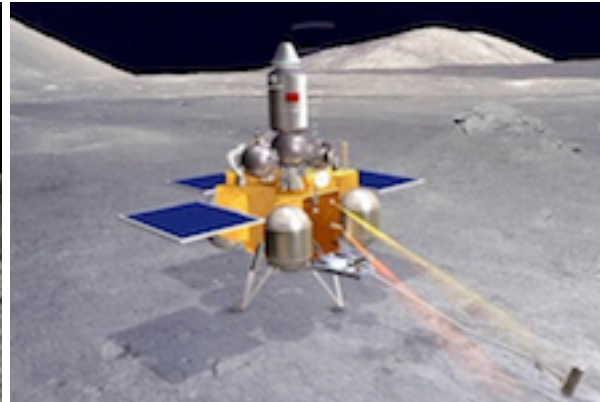

Story below

## The challenges of commercializing The “Asian Space Race” and China’s solar system exploration: domestic and international rationales

[www.thespacereview.com/article/3007/1](http://www.thespacereview.com/article/3007/1) by Cody knipfer

## Landers, laws, and lunar logistics

[www.thespacereview.com/article/3005/1](http://www.thespacereview.com/article/3005/1) by Jeff Foust

## What Happens When the Sky Starts to Fall?

[http://tasmaniantimes.com/index.php?/weblog/article/what-happens-when-the-sky-starts-to-fall/show\\_comments/](http://tasmaniantimes.com/index.php?/weblog/article/what-happens-when-the-sky-starts-to-fall/show_comments/) by Kim Pearl

## Jeff Bezos: NASA Pursue Prizes and 'Gigantic' Technology Programs

[www.space.com/33209-jeff-bezos-says-nasa-should-pursue-prizes-space-tech-programs.html](http://www.space.com/33209-jeff-bezos-says-nasa-should-pursue-prizes-space-tech-programs.html)

By Jeff Bezos

## The Human Exploration of Mars: A Congressional Opportunity

<http://spaceref.com/news/viewpr.html?pid=48694>

Press Release from Explore Mars

## List of Recent Feature Articles and Essays in Our Sister Publications



Ad Astra [Latin (ancient Roman): "To The Stars"]

Sent to all National Space Society Members as a primary membership benefit  
(with choice of print hardcopy or downloadable pdf file)

### SUMMER 2016

- 12 **In Situ Resource Utilization: Living off the Land as if Your Life Depended on it** – John F. Kross
- 16 **Getting Serious about Planetary Defence** – Clifford R. McMurray
- 20 **Meet the Eight-Balls** – Travis R. Kircher
- 24 **Space Suits me Just Fine** (space suits) – John F. Kross
- 28 **Asteroid Mining: Viable, Affordable, and Soon** – Dan Ward



[www.MMM-MoonMinersManifesto.com](http://www.MMM-MoonMinersManifesto.com)

### MAY 2016 – MMM #295

- 2 **In Focus:** The Moon may be responsible for Earth's Protective Magnetic Van Allen Belts
- 3. **Is the Earth-Moon system** another type of "Binary Planet"?  
What Earth's history means for the search for other "Earth-like Planets"
- 4. **Mercury** – What we have learned in the past three decades]
- 5. **Venus** – What we have learned in the past three decades
- 6. **Mars** – What we have learned in the past three decades
- 7. **Propellant** for Lunar Spacecraft – Dave Dietzler'

### JUNE 2016 – MMM #296

- 2 **In Focus:** The need to develop faster rockets, much much faster!
- 3. Jupiter and its moons: what we have learned and still need to learn
- 4. Saturn and Titan: what we have learned and still need to learn
- 5. Uranus and Neptune and their moons – – What we have learned and still need to learn

As usual, there is no July (or January) issue of MMM

### Note: The Future of MMM:

After MMM #297 August, #298 September, #299 October, #300 November, and #301 December (30<sup>th</sup> Anniversary issue) – MMM will be discontinued.

To date, there have been no solid offers of other prospective editors to take over where we are leaving off.

As to the Moon Society, Chairman of the Board Philip Crume has indicated he may put out a pair of publications, format not mentioned, to serve members of the Society.

MMM also has been serving a number of National Space Society chapters for some time. Again, there are no plans or suggestions how this gap may be filled.

The past thirty years have been a blast. --- Peter Kokh, founder and editor from the start.



## International Space Advocacy Organizations Encouraging Student Participation

**National Space Society (US)** – <http://www.nss.org> – NSS

NSS currently has chapters in Australia, Canada, Germany, France, Netherlands, Brazil, and India  
<http://www.nss.org> – <http://chapters.nss.org/a/lists/>

**NSS' International Space Development Conference – ISDC**

The “ISDC” is usually held the weekend of the last Monday in May (Memorial Day weekend) in various locations, hosts students from around the world, many of them presenting their entries to NASA’s annual Space Settlement Design Contest. Usually, The Moon Society and SEDS participate in this conference.  
<http://isdc.nss.org>

**The Moon Society** – <http://www.moonsociety.org> – TMS

The Moon Society has informal relationships with the Calgary Space Workers, Calgary, Alberta, Canada and with the Sociedad Espacial Mexicano, Mexico, with individual members in many countries.

The Moon Society’s **Moon Miners’ Manifesto India Quarterly** – the “older sister” to To The Stars International Quarterly, has been going to students and others in India and Elsewhere since August 2008. Older issues are available as free pdf downloads at:

<http://www.moonsociety.org/india/mmm-india/>

With the previous issue, TTSIQ#6, that publication replaces M3IQ.

**Students for the Exploration and Development of Space – SEDS** – <http://www.seds.org>

SEDS has had more success in setting up chapters around the World than any other Space organization.

How to Stars a SEDS Chapter – [http://wiki.seds.org/index.php?title=Start\\_a\\_SEDS\\_Chapter](http://wiki.seds.org/index.php?title=Start_a_SEDS_Chapter)

<http://seds.org/chair/ChapterExpansionKit30.pdf>

SEDS–Earth – <http://earth.seds.org/index.php> – This is the international chapter.

There are chapters of SEDS around the world: (USA), **India, Nigeria, United Kingdom, Philippines**, and more; SEDS–Earth is a central node for communication between these worldwide chapters.

**YURI’S NIGHT** – <https://yurisnight.net> – [http://en.wikipedia.org/wiki/Yuri's\\_Night](http://en.wikipedia.org/wiki/Yuri's_Night)

An Annual Celebration around the world, on April 12<sup>th</sup>, celebrating the first manned flight in space by Yuri Gagarin, of the Soviet Union, who piloted the first manned space capsule, **Vostok 1**, and made a complete orbit and landed safely in 1961.

**STEM – The STEM Academy** – <http://www.stem101.org/about.asp>

[STEM: an acronym for **Science, Technology, Engineering, and Math**]

The STEM Academy, Inc. is a national non-profit status organization dedicated to advancing economic development by improving STEM literacy for all students. State and national standards based K–16 STEM curriculum to create student pathways for industry and post-secondary advancement.

**Available Space Topic STEM Videos**

- <http://www.nasa.gov/audience/foreducators/expeditions/stem/>
- <http://www.nasa.gov/audience/foreducators/expeditions/stem/stem-science-index.html>
- <http://www.nasa.gov/audience/foreducators/expeditions/stem/stem-tech-index.html>
- <http://www.nasa.gov/audience/foreducators/expeditions/stem/stem-eng-index.html>
- <http://www.nasa.gov/audience/foreducators/expeditions/stem/stem-math-index.html>

## NASA hosts Student Rocket Launch, Robotics Challenge

11 April, 2016 – [www.nasa.gov/press-release/nasa-hosts-student-rocket-launch-robotics-challenge](http://www.nasa.gov/press-release/nasa-hosts-student-rocket-launch-robotics-challenge)

NASA will host almost 50 high school, college and university teams from 22 states at its 16th annual Student Launch competition and **2nd annual Mars Ascent Vehicle (MAV) Challenge**, April 13–16 in **Huntsville and Toney, Alabama**. These events engage students in NASA's **Journey to Mars** through hands-on activities in the areas of science, technology, engineering and math (STEM)

**MAV Challenge:** An answer the need for autonomous robotic systems in space exploration, student teams were challenged to design & build a system capable of retrieving and storing samples. Student teams will demonstrate the capabilities of their designs for a share of the \$50,000 cash prize.

**NASA Astronaut Presentation:** NASA astronaut Kjell Lindgren, a Space Station Expedition 44/45 crew member, will meet with students to talk about his career as an astronaut..

**Rocket Fair:** Student teams will give technical presentations of their rocket's design and payload.

**Student Launch:** This event gives aspiring engineers a chance to test their high-flying creations. For a shot at a \$5,000 cash prize, the student-designed and built rockets must fly to an altitude of one mile, deploy an automated parachute system, and safely land where they can be recovered.

[www.nasa.gov/education/studentlaunch](http://www.nasa.gov/education/studentlaunch) ##

## Beautifully detailed 3D printed Moon brings lunar light into your home

[www.3ders.org/articles/20160413-beautifully-detailed-3d-printed-moon-brings-lunar-light-into-your-home.html](http://www.3ders.org/articles/20160413-beautifully-detailed-3d-printed-moon-brings-lunar-light-into-your-home.html)



14 April, 2016 – Thanks to a brilliant combination of NASA Lunar data, 3D printing technology, and exquisite engineering, a team of designers has created MOON, the first topographically accurate lunar globe that displays actual lunar phases in real-time.

## Best Space Books and Sci-Fi: A Space.com Reading List

[www.space.com/28973-best-space-books.html](http://www.space.com/28973-best-space-books.html)





## A Beautiful Planet: A 3D Film of Earth from Space

[www.space.com/32743-beautiful-planet-imax-film-earth-from-space.html](http://www.space.com/32743-beautiful-planet-imax-film-earth-from-space.html)

IMAX trailer transports you to International Space Station viewpoints

## NASA Puts Dallas Students on Phone with Orbiting Astronauts

[www.nasa.gov/press-release/nasa-puts-dallas-students-on-phone-with-orbiting-astronauts](http://www.nasa.gov/press-release/nasa-puts-dallas-students-on-phone-with-orbiting-astronauts)

25 April, 2016 – Students in Dallas had the opportunity to speak with two astronauts living and working aboard the International Space Station at 11:15 a.m. EDT Tuesday, April 26. The 20-minute, Earth-to-space call aired live on NASA Television and the agency's website. ##

## Elementary School Built Cubesat Launched From Space Station Video

[www.space.com/32908-elementary-school-built-cubesat-launched-from-space-station.html](http://www.space.com/32908-elementary-school-built-cubesat-launched-from-space-station.html)



St. Thomas More Cathedral School (Arlington, CA) students built the STMSat-1 cubesat to photograph Earth and transmit the imagery to remote ground stations in the United States. It was launched from the International Space Station's NanoRacks CubeSat Deployer (NRCSD) system on May 16, 2016. The cubesat was launched to Space Station aboard a Cygnus cargo spacecraft mission. ##

## Best Space-Themed Summer Gifts for Kids

[www.space.com/27797-kids-gifts.html](http://www.space.com/27797-kids-gifts.html)



A Space tent, a rover, and much more ##

## Genes in Space Student Experiment Probes Astronaut DNA

[www.space.com/32779-genes-in-space-experiment-astronaut-dna.html](http://www.space.com/32779-genes-in-space-experiment-astronaut-dna.html)

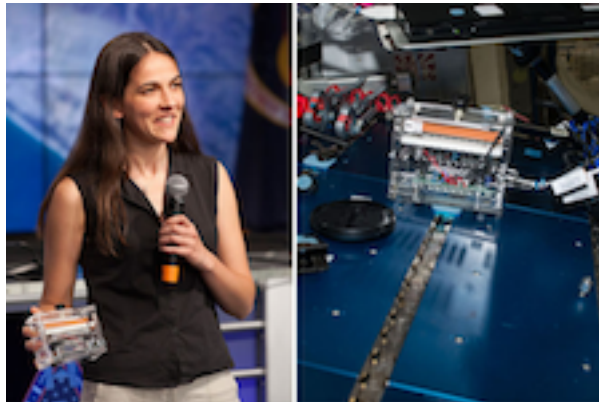

17-year-old Anna-Sophia Boguraev created a winning experiment for the "Genes in Space" program that is currently testing DNA-amplification on the International Space Station.

## Stargazing This Summer? Try a National or State Park

[www.space.com/32816-summer-stargazing-national-state-parks-travel.html](http://www.space.com/32816-summer-stargazing-national-state-parks-travel.html)

The vast majority of people reside in big cities and their immediate suburbs. In those locations, it is all but impossible to see the night sky in all of its grandeur.

As the warmer summer months get closer, many people are contemplating where to spend their vacation. If you're thinking of stargazing, the very best place you can go is a state or national park. ##

## These Single-Person Spaceship Ideas by Students Are Just Wild

[www.space.com/32835-single-person-spacecraft-ideas-student-engineering-contest.html](http://www.space.com/32835-single-person-spacecraft-ideas-student-engineering-contest.html)

In the annals of spaceflight history, only a handful of Russian and American space travelers have experienced single-person orbital flight. But a recent three-month student competition has led to some creative interiors for a single-person spacecraft.

Genesis Engineering Solutions (GES) in Lanham, Maryland sponsored the engineering design contest as a way to integrate student creativity into the development of their Single-Person Spacecraft (SPS) concept. According to GES, the SPS includes an inner pressure vessel for shirtsleeve (normal clothing) operations and an outer unpressurized cylinder

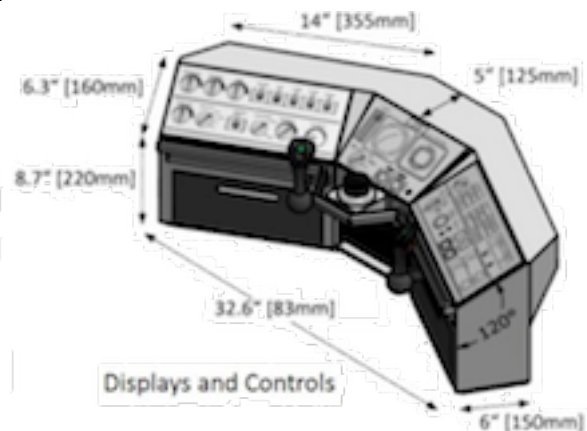
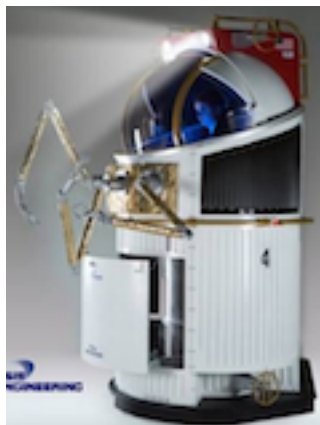

## “Astronomy” and “Space Apps” for Smart Phones & Tablets

Courtesy of the Editor

### What is available??? Google finds the following

#### International Space Apps Challenge

[https://en.wikipedia.org/wiki/International\\_Space\\_Apps\\_Challenge](https://en.wikipedia.org/wiki/International_Space_Apps_Challenge)

"The International Space Apps Challenge is an international mass collaboration focused on space exploration that takes place over 48-hours in cities around the world. The event embraces collaborative problem solving with a goal of producing relevant open-source solutions to address global needs applicable to both life on Earth and life in space...NASA is leading this global collaboration along with a number of government collaborators and over 100 local organizing teams across the globe."<sup>[1]</sup>

Space Apps is annual NASA's global [hackathon](#), first held in April 2012,<sup>[2]</sup> and serves as innovation incubation program. NASA and its partners put out challenges relating to current work for which space enthusiasts around the world of all backgrounds can develop innovative solutions (which can be more than just apps!), particularly focusing on use of NASA data and promoting education.

#### Technology drives Exploration <https://2016.spaceappschallenge.org/challenges/tech>

- Jetset Mars: <https://2016.spaceappschallenge.org/challenges/tech/jet-set-mars>
- Print my Rocket: <https://2016.spaceappschallenge.org/challenges/tech/print-my-rocket>
- Backfill my model: <https://2016.spaceappschallenge.org/challenges/tech/backfill-my-model>

#### Aeronautics: NASA is with you when you fly

- Don't Crash my Drone: <https://2016.spaceappschallenge.org/challenges/aero/dont-crash-my-drone>
- Clouds or Contrails?: <https://2016.spaceappschallenge.org/challenges/aero/clouds-or-contrails>
- Clear for Takeoff: <https://2016.spaceappschallenge.org/challenges/aero/clear-for-take-off>

#### Space Station <https://2016.spaceappschallenge.org/challenges/space-station>

- Launch: a Global Experience: <https://2016.spaceappschallenge.org/challenges/space-station/launch-a-global-experience>
- Rock-it Space Fashion & Design: <https://2016.spaceappschallenge.org/challenges/space-station/rock-it-space-fashion-and-design>
- Astrosize: <https://2016.spaceappschallenge.org/challenges/space-station/astrosize>

#### Ten Best Space Apps | Android, iPhone, iPad – Laptop Mag

<http://www.laptopmag.com/articles/best-space-apps#sthash.DG2osHtm.dpuf>

The NASA App (Free, Android, iOS) serves as a gateway to the latest news from the world's premier space agency. The app provides access to a huge amount of information about NASA, its many missions and the cosmos, delivered via feature stories, photos, videos, live webcasts and more.

- Space Images (free; iOS and Android)
- Exoplanet (free; iOS)
- Planets (free; iOS and Android)
- Sky Safari 3 (\$2.99; iOS and Android)
- Satellite Flybys (\$2.99; iOS and Android)
- NASA Space Weather Media Viewer (free; iOS and Android)
- Mars Globe (free, version with HD 99 cents; iOS)
- Moon Phase Pro (99 cents; Android)
- Galaxy Collider (99 cents; iOS)

#### MORE: SpaceApps is a NASA incubator innovation program.

<https://open.nasa.gov/explore/space-apps/> -

Global citizens work with open data and APIs to solve challenges within categories designed to support NASA's ongoing missions. As a result, participants produce hundreds of projects making open source solutions with immediate value to NASA and the global community. <https://2016.spaceappschallenge.org>

#### Exploring the Moon by Hand with Mobile Astronomy Apps

[www.space.com/32667-explore-the-moon-mobile-astronomy.html](http://www.space.com/32667-explore-the-moon-mobile-astronomy.html)

#### Mars on the Go! NASA Be A Martian Mobile App – <http://mars.nasa.gov/mobile/info/>

#### Moon Society / National Space Society input on Space Apps creation and promotion

Help brainstorm Apps that “explore” the Moon and Mars and options for “permanent human settlement” on both worlds. APPS are important! They appeal to persons who want to do more than just “read” the latest news, but who want to help explore and settle these worlds. **We need Apps to explore Europa's Ocean and Titan's Lakes as well as to “design” settlements on all these worlds as well as in free space!**

Most importantly, Apps are “The Key” to involving young people!

PK

## Astronomy Student discovers Four New Planets

31 May, 2016 – <http://phys.org/news/2016-05-astronomy-student-planets.html>

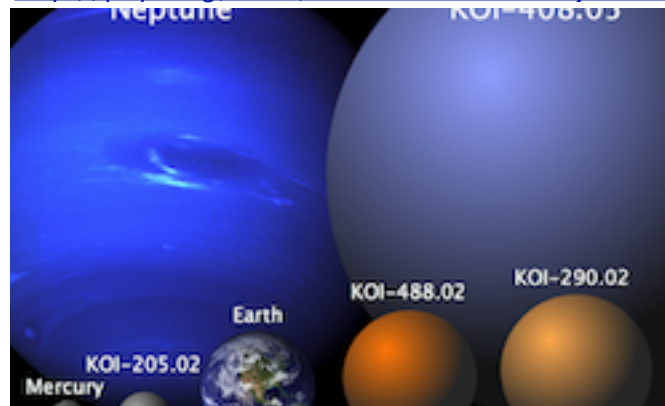

The sizes of the four new planets, shown to scale.

**Michelle Kunimoto's** bachelor degree in physics and astronomy sent her on a journey out of this world—and led to the discovery of four new worlds beyond our solar system.

The planets, designated "planet candidates" until independently confirmed, are exciting discoveries.

- Two are the size of Earth
- One is Mercury-sized,
- One is slightly larger than Neptune.

But it's this last one, the largest of the four, that is of special interest. Officially catalogued as **KOI** (Kepler Object of Interest) **408.05** and located **3,200 light years** away from Earth, the planet occupies the habitable zone of its star where the temperature would allow liquid water and maybe life.

"Like our own Neptune, it's unlikely to have a rocky surface or oceans," ##

## How to Throw a Star Party: A Stargazing Guide

[www.space.com/33031-how-to-throw-a-star-party.html](http://www.space.com/33031-how-to-throw-a-star-party.html)

Amateur astronomy may very well be the oldest of the scientific hobbies. If you or your local astronomy club have ever thought about conducting a "[star party](#)," here are some tips.

### **Pick a good site**

Even if you live in an urban area, try to find a location that offers as wide a view of the sky as possible, free from obstructions such as tall buildings. ....

### **How many did you say?**

If you're planning for a large gathering, with several telescopes or more, try promoting the event through your local newspaper or radio station. (Make sure you have an alternate night set up in case of cloudy weather.) ....

### **Use just your eyes at first**

Naked-eye astronomy is also especially rewarding if you're observing with children, ....

### **Next comes your telescope**

Then, after you point out the more prominent sky objects, you can direct your audience to look at a particular object through your telescope. ....

### **What to use for a pointer**

If you plan on pointing out stars and constellations at a star party, using your index finger in the dark is simply not going to cut it, especially if you have a large group of people surrounding you. ....

### **Final suggestions**

If you have a telescope and don't already belong to an amateur astronomical organization , local or national, you ought to join one. ....

## Moon Miners' Manifesto Resources

<http://www.moonsociety.org/chapters/milwaukee/mmm/>

MMM is published 10 times a year (exc. Jan July). The December 2014 issue begins year # 28.

Most issues deal with the **opening of the Lunar frontier**, suggesting how pioneers can make best use of **local resources** and learn to **make themselves at home**, through psychological, social, and physiological adjustment.

Some of the points made will relate specifically to **pioneer life** in the lunar environment. Much of what will hold for the Moon, will also hold true for **Mars and for space in general**. There is one Mars theme issue each year. **Other space destinations** are discussed: the asteroids, moons of Jupiter and Saturn), even the cloud tops of Venus.

Issues #145 (May 2001) forward through current are as pdf file downloads with a Moon Society username and password. Moon Society International memberships are \$35 US; \$20 students, seniors – join online at:

<http://www.moonsociety.org/register/>

**MMM Classics:** All the “non-time-sensitive editorials and articles from past issues of MMM have been re-edited and republished in pdf files, one per publication year. A 3-year plus lag is kept between the MMM Classic volumes and the current issue. **As of December 2011, the first twenty-two years of MMM, 200 issues, will be preserved in this directory**, These issues are freely accessible to all, no username or password needed, at:

[www.moonsociety.org/publications/mmm\\_classics/](http://www.moonsociety.org/publications/mmm_classics/)

**MMM Classic Theme Issues:** introduced a new series to collect the same material as in the Classics, but this time organized by theme. The first MMM Classic Theme issue gathers all the **Mars** theme articles from years 1–10 in one pdf file. A second pdf file collects all the Mars Theme issues from year 11–20. The 2<sup>nd</sup> Classic Theme is “**Eden on Luna**,” addressing environmental issues underlying lunar settlement. **Asteroids, Tourism, Research, Select Editorials, and Analog Programs** have been added. New Theme Issues will be coming: Lunar Building Materials, The Lunar Economy, The Lunar Homestead, Modular Architecture, Modular Biospherics, Frontier Arts & Crafts, Frontier Sports, Other Solar System Destinations, and so on.

[www.moonsociety.org/publications/mmm\\_themes/](http://www.moonsociety.org/publications/mmm_themes/)

**MMM Glossary:** The publishers of MMM, the Lunar Reclamation Society, has published a new Glossary of “MMM-Speak: new words and old words with new meaning” as used in Moon Miners' Manifesto.

[www.moonsociety.org/publications/m3glossary.html](http://www.moonsociety.org/publications/m3glossary.html)

The initial addition includes over 300 entries, many with illustrations. Additional entries are under construction. It is hoped that new members will consider this to be a “Read Me First” guide, not just to Moon Miners' Manifesto, but to our vision and goals.

**All of these resources are available online or as free access downloads to readers.**

**But TTSIQ does need your help!**

### **To The Stars International Quarterly Advisors, Liaisons, Contributors, Reporters, Illustrators**

If this publication is to help spread the word about Space worldwide, among the public at large, especially among the students and younger people, it must become a truly International publication. We need people from many fields and many nations to join our team.

If you can add to the usefulness and vitality of this publication, in any of the ways listed above, or in fields we had not thought of, write us at: [ttsiq@moonsociety.org](mailto:ttsiq@moonsociety.org) [This email address goes to the whole editorial team]

Tell us about yourself; your interest in space, and how you think you can make this publication of real service in the education of the public worldwide, and in the education of young people on whom our future rests.

**Guidelines for Submissions:** TTSIQ is intended for wide public distribution to encourage support for space research and exploration and development. TTSIQ is not a scholarly review or a technical journal for professional distribution. Submissions should be short, no more than a few thousand words. Longer pieces may be serialized editorials and commentary, reports on actual developments and proposals, glimpses of life on the future space frontier, etc. Articles about launch vehicles, launch facilities, space destinations such as Earth Orbit, The Moon, Mars, the asteroids, and beyond, challenges such as moondust, radiation, reduced gravity, and more.

### **Help Circulate To The Stars International Quarterly**

If you know someone who might enjoy reading this publication, send us their email address(es) so that they receive notice when a new issue is published. Readers are encouraged to share and to distribute these issues widely, either as email attachments, or via the direct download address (for all issues):

<http://www.nss.org/tothestars/> and <http://www.moonsociety.org/international/ttsiq/>

**To The Stars International Quarterly #16: July 2016 Index****INDEX**

2 Co-sponsoring Organizations

**NEWS SECTION pp. 3-89**

3-22 Earth Orbit and Mission to Planet Earth

23 Space Tourism

23-31 Cislunar Space and the Moon

32-48 Mars

49-52 Asteroids & Comets

53-69 Other Planets & their moons

70-89 Starbound

**ARTICLES, ESSAYS pp 91-107**

91 A list of more "Human Space Firsts" Peter Kokh

92 Geologically "Earthlike" worlds without a large moon might not host life, P. Kokh

93 At last, the BEAM inflatable test module is attached to the Space Station

95 Spotting a Ringworld edge on against its sun as seen from Earth

96 A US Department of Space – Madhu Thangavelu

99-103 New Challenges in Space For the Next President of United States: The United States and Its International and Commercial Partners can Reshape Federal Space Priorities Dave Dunlop

104-107 What Happens When the Sky Starts to Fall? Kim Pearl

108-109 OP-ED Articles

111 List of major articles in our sister publications: Ad Astra and Moon Miners' Manifesto

**STUDENTS & TEACHERS pp 112-116****To The Stars International Quarterly #16**

Engage! And Enjoy! - published July 1, 2016