

4. Lunar Architecture

4.1 Summary and Recommendations

As defined by the Exploration Systems Architecture Study (ESAS), the lunar architecture is a combination of the lunar “mission mode,” the assignment of functionality to flight elements, and the definition of the activities to be performed on the lunar surface. The trade space for the lunar “mission mode,” or approach to performing the crewed lunar missions, was limited to the cislunar space and Earth-orbital staging locations, the lunar surface activities duration and location, and the lunar abort/return strategies. The lunar mission mode analysis is detailed in **Section 4.2, Lunar Mission Mode**. Surface activities, including those performed on sortie- and outpost-duration missions, are detailed in **Section 4.3, Lunar Surface Activities**, along with a discussion of the deployment of the outpost itself.

The mission mode analysis was built around a matrix of lunar- and Earth-staging nodes. Lunar-staging locations initially considered included the Earth-Moon L1 libration point, Low Lunar Orbit (LLO), and the lunar surface. Earth-orbital staging locations considered included due-east Low Earth Orbits (LEOs), higher-inclination International Space Station (ISS) orbits, and raised apogee High Earth Orbits (HEOs). Cases that lack staging nodes (i.e., “direct” missions) in space and at Earth were also considered.

This study addressed lunar surface duration and location variables (including latitude, longitude, and surface stay-time) and made an effort to preserve the option for full global landing site access. Abort strategies were also considered from the lunar vicinity. “Anytime return” from the lunar surface is a desirable option that was analyzed along with options for orbital and surface loiter.

The duration, location, and centralization of lunar surface activities were analyzed by first determining the content of the science, resource utilization, Mars-forward technology demonstrations, and operational tests that could be performed during the lunar missions. The study team looked at high-priority landing sites and chose a reference site in order to further investigate the operations at a permanent outpost. With the scientific and engineering activities defined, concept-level approaches for the deployment and buildup of the outpost were created. A comprehensive definition of lunar surface elements and infrastructure was not performed because development activities for lunar surface elements are still years in the future. Therefore, the ESAS team concentrated its recommendations on those elements that had the greatest impact on near-term decisions.

The mission architecture decisions that most greatly affect near-term NASA development activities are mission mode, propulsion system types, and mission duration. The ESAS team recommends the use of an Earth Orbit Rendezvous-Lunar Orbit Rendezvous (EOR-LOR) mission mode. This mission mode, which can be executed with a combination of the launch of separate crew and cargo vehicles, was found to result in a Low Life Cycle Cost (LCC) and the highest crew safety and mission reliability combination. Further, the study found that pressure-fed Liquid Oxygen (LOX)/methane propulsion should be used for the lander ascent stage as well as the Crew Exploration Vehicle (CEV) Service Module (SM), which should be sized to perform the Trans-Earth Injection (TEI) propulsive maneuver for a lunar mission. The study also concluded that the lunar lander should use a LOX/hydrogen throttleable propulsion system for Lunar Orbit Insertion (LOI) and landing. The two-stage lander should include an airlock and be sized to support a 7-day surface mission with four crew members.

4.2 Lunar Mission Mode

The lunar mission mode is the fundamental lunar architecture decision that defines where space flight elements come together and what functions each of these elements perform. Mission mode analysis had its genesis early in the design of the Apollo Program, with notable NASA engineers and managers such as Wernher Von Braun, John Houbolt, Joe Shea, and Robert Seamans contributing to the decision to use LOR as the Apollo mission mode. This study built on the foundation of the Apollo decision but sought to question whether the LOR decision and overall Apollo mission approach were still valid, given new missions requirements and technology.

The ESAS team researched many of the Apollo lunar landing mode comparison studies as well as more recent studies performed by both NASA and industry. One study of interest, performed by a Massachusetts Institute of Technology (MIT)-Draper Laboratory team as part of a “Concept Exploration and Refinement” (CE&R) contract to NASA, suggested that the Apollo mission mode was no longer valid and that NASA should consider “direct return” modes for future human lunar missions. The ESAS team took special note of this study and sought to challenge all of the Apollo mission assumptions.

4.2.1 Previous Lunar Architecture Study Results

Since its inception, NASA has conducted or sponsored numerous studies of human exploration beyond LEO. These studies have been used to understand requirements for human exploration of the Moon and Mars in the context of other space missions and Research and Development (R&D) programs. Each exploration architecture provides an end-to-end mission baseline against which other mission and technology concepts can be compared. The results from the architecture studies were used to:

- Derive technology R&D plans;
- Define and prioritize requirements for precursor robotic missions;
- Define and prioritize flight experiments and human exploration mission elements, such as those involving the Space Shuttle, ISS, and other Space Transportation Systems (STSs);
- Open a discussion with international partners in a manner that allows identification of participants’ potential interests in specialized aspects of the missions; and
- Describe to the public, media, and Government stakeholders the feasible, long-term visions for space exploration.

Each architecture study emphasized one or more critical aspects of human exploration in order to determine basic feasibility and technology needs. Examples of architectural areas of emphasis include:

- Destination: Moon ↔ Mars ↔ Libration Points ↔ Asteroids;
- System Reusability: Expendable ↔ Reusable;
- Architecture Focus: Sorties ↔ Colonization;
- Surface Mobility: Local ↔ Global;
- Launch Vehicles (LVs): Existing ↔ New Heavy-Lift;
- Transportation: Numerous stages and technologies traded;
- LEO Assembly: None ↔ Extensive;
- Transit Modes: Zero-gravity ↔ Artificial-gravity;
- Surface Power: Solar ↔ Nuclear;
- Crew Size: 4 ↔ 24; and
- In Situ Resource Utilization (ISRU): None ↔ Extensive.

The ESAS team extensively scrutinized the NASA studies that led to the Apollo Program, most notably studies to determine the shape of the Apollo capsule and the mode used for the Apollo missions. Additionally, the team reviewed the findings of human lunar and Mars mission studies performed over the past 15 years. A summary of these studies is shown in **Table 4-1**.

Office of Exploration (OExP) - 1988 Case Studies Human Expedition to Phobos Human Expedition to Mars Lunar Observatory Lunar Outpost to Early Mars Evolution	First Lunar Outpost - 1993
	Early Lunar Resource Utilization - 1993
	Human Lunar Return - 1996
	Mars Exploration Missions Design Reference Mission Version 1.0 - 1994 Design Reference Mission Version 3.0 - 1997 Design Reference Mission Version 4.0 - 1998 Mars Combo Lander (Johnson Space Center (JSC)) - 1999 Dual Landers – 1999
Office of Exploration (OExP) - 1989 Case Studies Lunar Evolution Mars Evolution Mars Expedition	
NASA 90-Day Study - 1989 Approach A - Moon as testbed for Mars missions Approach B - Moon as testbed for early Mars missions Approach C - Moon as testbed for Mars Outposts Approach D - Relaxed mission dates Approach E - Lunar outpost followed by Mars missions	Decadal Planning Team (DPT)/NASA Exploration Team (NEt) - 2000–2002 Earth's Neighborhood Architecture Asteroid Missions Mars Short and Long Stay
	Exploration Blueprint - 2002
	Space Architect - 2003
America at the Threshold - “The Synthesis Group” - 1991 Mars Exploration Science Emphasis for the Moon and Mars The Moon to Stay and Mars Exploration Space Resource Utilization	Exploration Systems Mission Directorate (ESMD) 2004–2005

Table 4-1. Summary of Previous NASA Architecture Studies

4.2.1.1 Summary of Previous Studies

4.2.1.1.1 Office of Exploration Case Studies (1988)

In June 1987, the NASA Administrator established the Office of Exploration (OExP) in response to an urgent national need for a long-term goal to reenergize the U.S. civilian space program. The OExP originated as a result of two significant assessments conducted prior to its creation. In 1986, the National Commission on Space, as appointed by the President and charged by the Congress, formulated a bold agenda to carry America's civilian space enterprise into the 21st century (number 1 in **Section 4.5, Endnotes**). Later that year, the NASA Administrator asked scientist and astronaut Sally Ride to lead a task force to look at potential long-range goals of the U.S. civilian space program. The subsequent task force report, "Leadership and America's Future in Space," (number 2 in **Section 4.5, Endnotes**) outlined four initiatives which included both human and robotic exploration of the solar system.

In response to the task force report, the OExP conducted a series of studies of human and robotic exploration beyond LEO during the 1987–1988 time frame. These studies ranged in scope and scale with the direct purpose of providing an understanding of the driving mission, technology, and operational concepts for various exploration missions. Four focused case studies were examined: Human Expeditions to Phobos, Human Expeditions to Mars, Lunar Observatory, and Lunar Outpost to Early Mars Evolution.

The case studies were deliberately set at the boundaries of various conditions in order to elicit first principles and trends toward the refinement of future options, as well as to define and refine prerequisites. The objective of this approach was to determine a viable pathway into the solar system and avoid making simple distinctions between Moon or Mars exploration.

Recommendations resulting from the 1988 (number 3 in **Section 4.5, Endnotes**) case studies included the following key points:

- A Space Station is the key to developing the capability to live and work in space;
- Continued emphasis on Research and Technology (R&T) will enable a broad spectrum of space missions and strengthen the technology base of the U.S. civilian space program;
- A vigorous life science research-based program must be sustained;
- A heavy-lift transportation system must be pursued with a capability targeted to transport large quantities of mass to LEO;
- Obtaining data via robotic precursor missions is an essential element of future human exploration efforts;
- An artificial gravity research program must be initiated in parallel with the zero-gravity countermeasure program if the U.S. is to maintain its ability to begin exploration in the first decade of the next century; and
- An advanced development/focused test program must be initiated to understand the performance and capability of selected new technologies and systems.

4.2.1.1.2 Office of Exploration Case Studies (1989)

Following the 1988 studies, the OExP continued to lead the NASA-wide effort to provide recommendations and alternatives for a national decision on a focused program of human exploration of the Solar System. Three case studies were formulated during 1989 for detailed development and analysis: Lunar Evolution, Mars Evolution, and Mars Expedition. In addition, a series of special assessments was conducted that focused on high-leverage areas which were independent of the case studies and covered a generally broad subject area with potential for significant benefit to all mission approaches. Special assessments included Power System, Propulsion System, Life Support Systems, Automation and Robotics, Earth-Moon Node Location, Lunar LOX Production, and Launch/On-Orbit Processing.

Results from the 1989 OExP studies were published in the Fiscal Year (FY) 1989 OExP Annual Report (number 4 in **Section 4.5, Endnotes**). Key conclusions from the 1989 studies included:

- Mars Trajectories: Human missions to Mars are characterized by the surface stay-time required—short-stay referring to opposition-class missions and long-stay pertaining to conjunction-class Mars missions;
- In-Space Propulsion: All-chemical-propulsive transportation results in prohibitive total mission mass for Mars missions (1,500–2,000 mT per mission). On the other hand, aerobraking utilization at Mars can provide significant mass savings (50 percent) as compared to all-chemical-propulsive transportation. Incorporation of advanced propulsion, such as nuclear thermal rockets or nuclear electric propulsion, can result in mission masses comparable to chemical/aerobraking missions;
- Reusable Spacecraft: Employment of reusable spacecraft is predominantly driven by economic considerations; however, reusing spacecraft requires in-space facilities to store, maintain, and refurbish the vehicles, or the vehicles must be designed to be space-based with little or no maintenance;
- In-Situ Resources: The use of in-situ resources reduces the logistical demands on Earth of maintaining a lunar outpost and helps to develop outpost operational autonomy from Earth; and
- Space Power: As the power demands at the lunar outpost increase above the 100 kWe level, nuclear power offers improved specific power.

4.2.1.1.3 NASA 90-Day Study (1989)

On July 20, 1989, the President announced a major new space exploration vision, asking the Vice President to lead the National Space Council in determining what would be needed to chart a new and continuing course to the Moon and Mars. To support this endeavor, the NASA Administrator created a task force to conduct a 90-day study of the main elements of a human exploration program (number 5 in **Section 4.5, Endnotes**). Data from this study was to be used by the National Space Council in its deliberations. Five reference approaches were developed, each of which was based on the President’s strategy of “Space Station, Moon, then Mars.” Regardless of the reference architecture, the study team concluded that Heavy-Lift Launch Vehicles (HLLVs), space-based transportation systems, surface vehicles, habitats, and support systems for living and working in deep space are required. Thus, the reference architectures made extensive use of the Space Station (Freedom) for assembly and checkout operations of reusable transportation vehicles, ISRU (oxygen from the lunar regolith), and chemical/aerobrake propulsion.

4.2.1.1.4 America at the Threshold – “The Synthesis Group” (1991)

In addition to the internal NASA assessment of the Space Exploration Initiative (SEI) conducted during the NASA 90-Day Study, the Vice President and NASA Administrator chartered an independent team called the Synthesis Group to examine potential paths for implementation of the exploration initiative (number 6 in **Section 4.5, Endnotes**). This group examined a wide range of mission architectures and technology options. In addition, the group performed a far-reaching search for innovative ideas and concepts that could be applied to implementing the initiative.

The Synthesis Group’s four candidate architectures were Mars Exploration, Science Emphasis for the Moon and Mars, The Moon to Stay and Mars Exploration, and Space Resource Utilization. Supporting technologies identified as key for future exploration included:

- HLLV (150–250 mT),
- Nuclear Thermal Propulsion (NTP),
- Nuclear electric surface power,
- Extra-Vehicular Activity (EVA) suit,
- Cryogenic transfer and long-term storage,
- Automated Rendezvous and Docking (AR&D),
- Zero-g countermeasures,
- Telerobotics,
- Radiation effects and shielding,
- Closed-loop life support systems,
- Human factors research,
- Lightweight structural materials,
- Nuclear electric propulsion, and
- In-situ resource evaluation and processing.

The Synthesis Group also conducted an extensive outreach program with nationwide solicitation for innovative ideas. The Vice President’s directive was to “cast the net widely.” Ideas were solicited from universities, professional societies and associations, the American Institute of Aeronautics and Astronautics (AIAA), the Department of Defense (DoD) Federal Research Review, the Department of Energy (DoE), the Department of the Interior, and the Aerospace Industries Association, as well as from announcements in the Commerce Business Daily. Nearly 45,000 information packets were mailed to individuals and organizations interested in the SEI, resulting in more than 1,500 submissions. According to a Synthesis Group statement at the time, “The ideas submitted showed innovative but not necessarily revolutionary ideas. The submissions supported a wide range of SEI mission concepts and architectures.”

In addition, the Synthesis Group provided specific recommendations for the “effective implementation of the Space Exploration Initiative,” including:

- Recommendation 1: Establish within NASA a long-range strategic plan for the nation’s civil space program, with the SEI as its centerpiece;
- Recommendation 2: Establish a National Program Office by Executive Order;
- Recommendation 3: Appoint NASA’s Associate Administrator for Exploration as the Program Director for the National Program Office;
- Recommendation 4: Establish a new aggressive acquisition strategy for the SEI;
- Recommendation 5: Incorporate SEI requirements into the joint NASA-DoD Heavy-Lift Program;
- Recommendation 6: Initiate a nuclear thermal rocket technology development program;
- Recommendation 7: Initiate a space nuclear power technology development program based on the SEI requirements;
- Recommendation 8: Conduct focused life sciences experiments;
- Recommendation 9: Establish education as a principal theme of the SEI; and
- Recommendation 10: Continue and expand the Outreach Program.

4.2.1.1.5 First Lunar Outpost (1993)

Following the Synthesis Group’s recommendations, NASA began the planning for implementation of the first steps of the SEI after completion of the Space Station, namely “back to the Moon, back to the future, and this time, back to stay.” This activity was termed the First Lunar Outpost, (number 7 in **Section 4.5, Endnotes**) an Agency-wide effort aimed at understanding the technical, programmatic, schedule, and budgetary implications of restoring U.S. lunar exploration capability. Emphasis was placed on minimizing integration of elements and complex operations on the lunar surface and high reliance on proven systems in anticipation of lowering hardware development costs. Key features of the First Lunar Outpost activity included:

- An evolutionary approach with emphasis on minimizing operational complexity;
- Initial missions’ reliance on proven operational approaches and technologies;
- Graceful incorporation of advanced operational and technology concepts into downstream missions;
- Initial exploratory lunar landings at a few sites prior to lunar outpost location selection;
- An HLLV with a 200-mT delivery capability;
- A mission strategy of a direct descent to the lunar surface and direct return to Earth;
- Large pre-integrated systems designed for immediate occupancy by the crew of four;
- Simulation of ground and planetary operations for future Mars missions; and
- Engineering evaluation of transportation and surface systems with Mars mission applications.

4.2.1.1.6 Human Lunar Return (1996)

In September 1995, the NASA Administrator challenged engineers at JSC to develop a human lunar mission approach, the Human Lunar Return (HLR) study, which would cost significantly less (by one to two orders of magnitude) than previous human exploration estimates. Key objectives of the HLR activity were to demonstrate and gain experience on the Moon with those technologies required for Mars exploration, initiate a low-cost approach for human exploration beyond LEO, establish and demonstrate technologies required for human development of lunar resources, and investigate the economic feasibility of commercial development and utilization of those resources. The HLR study served as a radical approach from previous missions as evidenced by the “open cockpit” approach for the human lunar landers, reliance on existing small-capacity LVs (Proton and Shuttle), utilization of the Space Station as a staging node, and limited crew size (two) and short duration (3 days on the lunar surface). Activities associated with the HLR effort ended on August 7, 1996—the same day that scientists announced they had found evidence of ancient life in a meteorite from Mars. The HLR study represents the minimum mission approach for a return to the Moon capability.

4.2.1.1.7 Mars Exploration Design Reference Missions (1994–1999)

From 1994 to 1999, the NASA exploration community conducted a series of studies focused on the human and robotic exploration of Mars. Key studies included Mars Design Reference Mission (DRM) 1.0 (number 8 in **Section 4.5, Endnotes**), Mars DRM 3.0 (number 9 in **Section 4.5, Endnotes**), Mars Combo Lander, and Dual Landers (number 10 in **Section 4.5, Endnotes**). Each subsequent design approach provided greater fidelity and insight into the many competing needs and technology options for the exploration of Mars. Key mission aspects of each of these studies included the following:

- **Mission Mode:** Each of the Mars mission studies during this period employed conjunction-class missions, often referred to as long-stay missions, to minimize the exposure of the crew to the deep-space radiation and zero-gravity environment, while at the same time maximizing the scientific return from the mission. This is accomplished by taking advantage of optimum alignment of the Earth and Mars for both the outbound and return trajectories by varying the stay-time on Mars rather than forcing the mission through non-optimal trajectories as in the case of the short-stay missions. This approach allows the crew to transfer to and from Mars on relatively fast trajectories, on the order of 6 months, while allowing them to stay on the surface of Mars for a majority of the mission, on the order of 18 months.
- **Split Mission:** The surface exploration capability is implemented through a split mission concept in which cargo is transported in manageable units to the surface, or Mars orbit, and checked out in advance of committing the crews to their mission(s). Emphasis is placed on ensuring that the STSs could be flown in any Mars injection opportunity. This is vital in order to minimize the programmatic risks associated with funding profiles, technology development, and system design and verification programs.
- **Heavy-Lift Launch:** HLLVs were utilized in each of these studies due to the large mission mass for each human mission to Mars (on the order of the ISS at assembly complete) as well as the large-volume payloads required.
- **Long Surface Stay:** Emphasis was placed on the surface strategy associated with each mission approach. Use of conjunction-class missions provides on the order of 500 days on the surface of Mars for each human mission.

In order to view its lunar mission design work in the larger context of a future human Mars mission, the ESAS team chose Mars DRM 3.0 as the baseline Mars mission. This choice allowed the ESAS team to choose technologies, spacecraft designs, LVs, and lunar operational demonstrations that were extensible to future Mars missions.

4.2.1.1.8 Decadal Planning Team/NASA Exploration Team (2000–2002)

In June 1999, the NASA Administrator chartered an internal NASA task force, termed the Decadal Planning Team (DPT), to create a new integrated vision and strategy for space exploration. The efforts of the DPT evolved into the Agency-wide team known as the NASA Exploration Team (NExT) (number 11 in **Section 4.5, Endnotes**). This team was also instructed to identify technology roadmaps to enable the science-driven exploration vision and establish a cross-Enterprise, cross-Center systems engineering team with emphasis focused on revolutionary, not evolutionary, approaches. The strategy of the DPT and NExT teams was to “Go Anywhere, Anytime” by conquering key exploration hurdles of space transportation, crew health and safety, human/robotic partnerships, affordable abundant power, and advanced space systems performance. Early emphasis was placed on revolutionary exploration concepts such as rail gun and electromagnetic launchers, propellant depots, retrograde trajectories, nanostructures, and gas core nuclear rockets. Many of these revolutionary concepts turned out to be either not feasible for human exploration missions or well beyond expected technology readiness for near-term implementation. Several architectures were analyzed during the DPT and NExT study cycles, including missions to the Earth-Sun Libration Point (L2), the Earth-Moon Gateway and L1, the lunar surface, Mars (short and long stays), near-Earth asteroids, and a 1-year round trip to Mars. Common emphases of these studies included utilization of the Earth-Moon Libration Point (L1) as a staging point for exploration activities, current (Shuttle) and near-term launch capabilities (Evolved Expendable Launch Vehicle (EELV)), advanced propulsion, and robust space power. Although much emphasis was placed on the utilization of existing launch capabilities, the teams concluded that missions in near-Earth space were only marginally feasible, and human missions to Mars were not feasible without a heavy-lift launch capability. In addition, the teams concluded that missions in Earth’s neighborhood, such as lunar missions, can serve as stepping-stones toward further deep-space missions in terms of proving systems, technologies, and operational concepts.

4.2.1.1.9 Integrated Space Plan (2002–2003)

During the summer of 2002, the NASA Deputy Administrator chartered an internal NASA planning group to develop the rationale for exploration beyond LEO. This team, termed the Exploration Blueprint team (number 12 in **Section 4.5, Endnotes**), performed architecture analyses to develop roadmaps for accomplishing the first steps beyond LEO through the human exploration of Mars. The previous NExT activities laid the foundation and framework for the development of NASA’s Integrated Space Plan. The reference missions resulting from the analysis performed by the Exploration Blueprint team formed the basis for requirements definition, systems development, technology roadmapping, and risk assessments for future human exploration beyond LEO. Emphasis was placed on developing recommendations for what could presently be done to affect future exploration activities. The Exploration Blueprint team embraced the “stepping-stone” approach to exploration, where human and robotic activities are conducted through progressive expansion outward beyond LEO. Results from this study produced a long-term strategy for exploration with near-term implementation plans, program recommendations, and technology investments. Specific results included the development of a common exploration crew vehicle concept, a unified space nuclear strategy, focused

bioastronautics research objectives, and an integrated human and robotic exploration strategy. Recommendations from the Exploration Blueprint team included the endorsement of the Nuclear Systems Initiative, augmentation of the bioastronautics research, a focused space transportation program including heavy-lift launch and a common exploration vehicle design for ISS and exploration missions, and an integrated human and robotic exploration strategy for Mars.

Following the results of the Exploration Blueprint study, the NASA Administrator asked for a recommendation by June 2003 on the next steps in human and robotic exploration in order to put into context an updated Integrated Space Transportation Plan (post-Columbia) to guide Agency planning (number 13 in **Section 4.5, Endnotes**). NASA was on the verge of committing significant funding to programs that would be better served if longer term goals were more evident, including the Orbital Space Plane (OSP), research on the ISS, the National Aerospace Initiative, the Shuttle Life Extension Program, Project Prometheus, and a wide range of technology development throughout the Agency. Much of the focus during this period was on integrating the results from the previous studies into more concrete implementation strategies in order to understand the relationship between NASA programs, timing, and resulting budgetary implications. This resulted in an integrated approach, including lunar surface operations to retire the risk of human Mars missions, the maximum use of common and modular systems including what was termed the “Exploration Transfer Vehicle,” Earth orbit and lunar surface demonstrations of long-life systems, collaboration of human and robotic missions to vastly increase mission return, and high-efficiency transportation systems (nuclear) for deep-space transportation and power.

4.2.1.1.10 Exploration Systems Mission Directorate (2004)

On January 14, 2004, the President announced a new Vision for Space Exploration (henceforth referred to here as the Vision). In his address, the President presented a bold, forward-thinking, practical, and responsible vision—one that will explore answers to long-standing questions of importance to science and society and will develop revolutionary technologies and capabilities for the future while maintaining good stewardship of taxpayer dollars.

NASA’s Exploration Systems Mission Directorate (ESMD) was created in January 2004 to begin implementation of the President’s Vision. ESMD’s Requirements Division conducted a formal requirements formulation process in 2004 to understand the governing requirements and systems necessary for implementing the Vision. Included in the process were analyses of requirements definition, exploration architectures, system development, technology roadmaps, and risk assessments for advancing the Vision (numbers 14 and 15 in **Section 4.5, Endnotes**). The analyses provided an understanding of what is required for human space exploration beyond LEO. In addition, these analyses helped identify system “drivers” (i.e., significant sources of cost, performance, risk, and schedule variation, along with areas needing technology development).

The requirements development process was initiated through the development of strategic campaigns that represent a range of potential approaches for implementing the Vision, specifically initial lunar missions that support long-term exploration endeavors. These strategic campaigns, often referred to as “architectures,” were derived directly from the Vision. The leading candidate architectural options were then studied in some detail in order to understand the sensitivity and relationships between the mission, system, and technology concepts within a feasible option. The analysis activities resulted in what was termed a “Point-of-Departure (POD) Architecture” to be used for further refinement as the Agency progressed toward the

System Requirements Review (SRR). Key features of the ESMD architecture include the following.

- **Lunar Landing Sites:** Emphasis was placed on developing an exploration architecture that would provide global access for short-duration missions. As the length of stay on the lunar surface was increased (up to 98 days), landing sites were limited to either the lunar poles or the equator due to the desire to retain the ability to return the crew to Earth without the need to wait for proper orbital alignment of transportation elements.
- **Mission Mode:** Several different staging strategies were examined, resulting in the selection of EOR (required for multiple launches) and LOR. The latter provided the best balance between overall mission mass and the capability for global access for short missions, as well as support for long-duration missions.
- **Propulsion:** Advanced chemical propulsion was determined to be a key element of the ESMD lunar exploration architecture. Propellant preferences included oxygen/hydrogen propulsion for the outbound mission phase and oxygen/methane for the lunar landing, lunar ascent, and Earth return phases.
- **Earth Landing:** Direct entry at Earth return was selected with water landing as the primary mode.
- **Multi-Mission:** Emphasis was also placed on developing a transportation system that could meet a range of other potential mission modes. Although not specifically required by ESMD at the time, the study showed that missions to the ISS, lunar libration points, and a staging point for Mars missions could be accommodated.
- **LV:** Many different LV concepts were studied, ranging from utilizing existing LVs (EELVs), to heavy-lift concepts derived from existing systems (EELVs and Shuttle), to completely new concepts. During this period, ESMD ruled out new clean-sheet concepts from an affordability perspective but made no other firm decisions on the LV to be used for the exploration architecture.

In addition to its in-house work, ESMD awarded a series of eleven CE&R contracts, with the goal of obtaining a broad set of vehicle concepts, mission architecture designs, and technology rankings from a diverse set of contractors that spanned the continuum from large and familiar aerospace corporations to small and aggressive aerospace entrepreneurs. The contractors were initially given only endpoint milestones and asked to assemble programs of vehicles and missions to achieve the endpoints. Several of the mission concepts produced by the CE&R contractors led directly to options studied further by the ESAS team.

4.2.1.2 Key Findings from Previous Architecture Studies

4.2.1.2.1 Strategy of Progressive Expansion

One common finding from the many previous studies is the stepping-stone approach to exploration that embraces a progressive expansion of human exploration beyond LEO. Under a stepping-stone approach, implementation is initiated with the establishment of key technical capabilities needed for the first step in the journey to deep space. The stepping-stone approach will build the technical capabilities needed for each step with multi-use technologies and capabilities. Each step will build on the previous step to avoid redevelopment of critical systems. The approach capitalizes on progressive exploration capabilities, where the experience and infrastructure gained from each step enables travel to new destinations.

4.2.1.2.2 Earth-to-Orbit (ETO) Transportation—Heavy-Lift

The various architecture studies over the years have emphasized the use of differing LV implementations, ranging from existing or near-existing capabilities, such as the EELV, to newly-designed HLLVs. These studies have shown that, even with the application of advanced technologies, exploration missions require significant initial mass in LEO, on the order of the mass of the ISS at assembly complete (470 mT). Missions in near-Earth vicinity, such as lunar missions, range from 120–220 mT, while Mars missions range from 400–800 mT or more for each human mission. Reducing the number of launches and the corresponding on-orbit assembly requirements can significantly reduce the overall cost and risk of human exploration missions. LV shroud volume is another key requirement for exploration missions. The diameter of the launch shroud has a profound influence on the design of the overall architecture, most importantly on the design of the lander systems. Delivery of the landing vehicle to LEO poses a significant challenge due to its large size (volume) for both lunar and Mars missions and the additional complexity of the aerodynamic shape of the lander required for Mars entry. The range of architecture studies has also shown that crew delivery and return for exploration missions is very similar to ISS crew return needs, and, thus, there is great potential for architecture synergy between LEO and beyond-LEO mission needs for crew delivery.

These studies have shown that architectures in near-Earth space utilizing near-term launch capabilities (e.g., EELV) are marginally feasible, operationally challenging, and very complex, whereas utilizing EELVs for Mars missions is not feasible due to the excessive number of launches required. These previous studies have shown that exploration launch needs (e.g., payload mass and volume) for near-Earth and Mars can be met with concepts evolved from Shuttle systems.

4.2.1.2.3 Crew Transportation—Common Vehicle

Another common thread through each of the exploration studies conducted over the past few years is the recognition of the applicability of a common vehicle design for many of the near-Earth exploration destinations. The performance requirements associated with missions to the ISS, lunar orbit, Earth-Moon libration points, and various Mars mission staging points are very similar in terms of overall mission duration, crew size requirements, and basic transportation payload capabilities. Entry speed at Earth return is the one key discriminator between the various near-Earth destinations, all of which can be satisfied through the choice of a mid-lift/drag vehicle design. Pursuit of this common vehicle design is the key to enabling a robust exploration capability beyond LEO.

4.2.1.2.4 Key Capabilities and Core Technologies

Previous NASA architecture studies have included such destinations as the Moon, near-Earth asteroids, Mars, and the moons of Mars. A review of these previous studies illustrates the existence of a common thread of key capabilities and core technologies that are similar between destinations. All of the technologies listed below do not need to be developed at the same time, but rather should be initiated consistent with the overall implemented exploration strategy.

Human Support

Human support technologies to be developed include the following:

- Radiation Protection: Protecting the exploration crew from both galactic cosmic radiation (remnants from the formation of the universe) and SPEs (solar flares from the Sun);
- Medical Care: Providing advanced medical diagnostic and treatment equipment to the crew in-situ and the corresponding data to the medical teams on Earth;
- Advanced Life Support: Advances in high-reliability, low-maintenance life support technologies are necessary to reduce the consumables required to support early human exploration missions; and
- Human Adaptation and Countermeasures: Advances to counter effects of long-duration space travel including bone decalcification, immune and cardiovascular system degradation, and other deleterious effects.

Transportation

Transportation technologies to be developed include the following:

- Low-Cost, Large Payload ETO: Providing the capability to efficiently and affordably deliver large payloads, in terms of mass and volume, to LEO;
- Advanced Chemical Propulsion: Highly efficient, restartable, and throttleable cryogenic main engines, which provide evolution potential to utilize locally produced propellants;
- Cryogenic Fluid Management (CFM): Providing the capability to manage large quantities of cryogenic fluids such as hydrogen, oxygen, and methane for long periods;
- Hazard Avoidance and Precision Landing: Precision landing and hazard avoidance technologies are also needed for planetary lander vehicles;
- AR&D: Providing the capability to perform rendezvous and docking of multiple elements in remote locations with limited or no support from ground or flight crews;
- Advanced Deep-Space Propulsion: Advanced propulsion concepts including solar electric, nuclear electric, and nuclear thermal propulsion are necessary to reduce the total mission mass for future human missions to Mars; and
- Aeroassist: Providing the capability for entry, descent, and soft landing of large systems is necessary for future human exploration of the Martian surface.

Power Systems

Power systems technologies to be developed include the following:

- Power Storage: Includes power generation, distribution, and control evolving from early exploration capabilities (10s kWe) to longer-term permanent human presence (1 MWe); and
- Power Management and Distribution: Power distribution needs for human exploration include efficient high-power distribution technologies and intelligent, self-diagnosing, and correcting power management and distribution systems.

Miscellaneous

Miscellaneous technologies to be developed include the following:

- Advanced EVA: Technologies that enable routine surface exploration are critical to exploration activities. This includes advanced EVA suits and short- and long-range rovers for surface exploration;
- Advanced Thermal Protection: This includes Thermal Protection Systems (TPSs) that can withstand the temperature extremes of lunar and Mars return missions;

- **ISRU:** Technologies for “living off the land” are needed to support a long-term strategy for human exploration. Key ISRU challenges include resource identification and characterization, excavation and extraction processes, consumable maintenance and usage capabilities, and advanced concepts for manufacturing other products from local resources; and
- **Supportability:** Required levels of operational availability and autonomy of spacecraft systems engaged in long-duration human exploration missions will be achieved in a combination of high reliability, adequate redundancy, and maintainability.

4.2.1.3 Applying the Results of Past Studies to ESAS

The ESAS team was fortunate to have the combined wisdom of the aerospace age on which to build. The team established “required reading” documents that included many of the studies performed in the early 1960s in support of the Apollo Program, many of the internal NASA human mission studies performed over the past 15 years, and the results of in-house and contracted studies performed most recently for ESMD. Many of the ESAS team members were steeped in the historical roots of the space program, but also represented the analytical core of modern NASA, with the ability to apply the latest tools and techniques to the analysis of vehicles, flight mechanics, reliability, safety, and cost.

4.2.2 Mission Mode Option Space

The lunar mission mode option space considered the location of “nodes” in both cislunar space and the vicinity of Earth. The study originally considered cislunar nodes at the Earth-Moon L1 libration point, in LLO, and on the lunar surface. Respectively, these translate to Libration Point Rendezvous (LPR), LOR, and Lunar Surface Rendezvous (LSR) mission modes. The study also considered Earth-orbital staging locations in LEO, higher-inclination ISS orbits, and raised-apogee HEO. In all three cases, elements brought together in any type of Earth orbit were generically termed an EOR mission mode. In the case of both cislunar and Earth orbital nodes, a mission type that bypassed a node completely was termed a “direct” mission or the term for the bypassed node was omitted altogether. Therefore, the Apollo missions were “direct” injection from Earth to the Moon, due to there being no EOR activities, and they were LOR at the Moon, owing to the rendezvous of the Command Module and lunar module (LM) following the surface mission. The Apollo mission mode was therefore popularly referred to as LOR.

LPR was eliminated early from the mission mode trade space. Recent studies performed by NASA mission designers concluded that equivalent landing site access and “anytime abort” conditions could be met by rendezvous missions in LLO with less propulsive delta-V and lower overall Initial Mass in Low Earth Orbit (IMLEO). If used only as a node for lunar missions, the L1 Earth-Moon LPR is inferior to the LOR mission mode.

With LPR eliminated, the mission mode question could be illustrated in a simple 2x2 matrix with the axes indicating the existence (or not) of an Earth-orbital and lunar-orbital node. The mission mode taxonomy could then be associated with each cell in this matrix—a mission that required EOR as well as rendezvous in lunar orbit was termed “EOR–LOR.” A mission that injected directly to the Moon (bypassing Earth-orbital operations) and returned directly from the surface of the Moon (bypassing lunar-orbital operations) was termed “direct-direct.”

Figure 4-1 illustrates the lunar mission mode matrix.

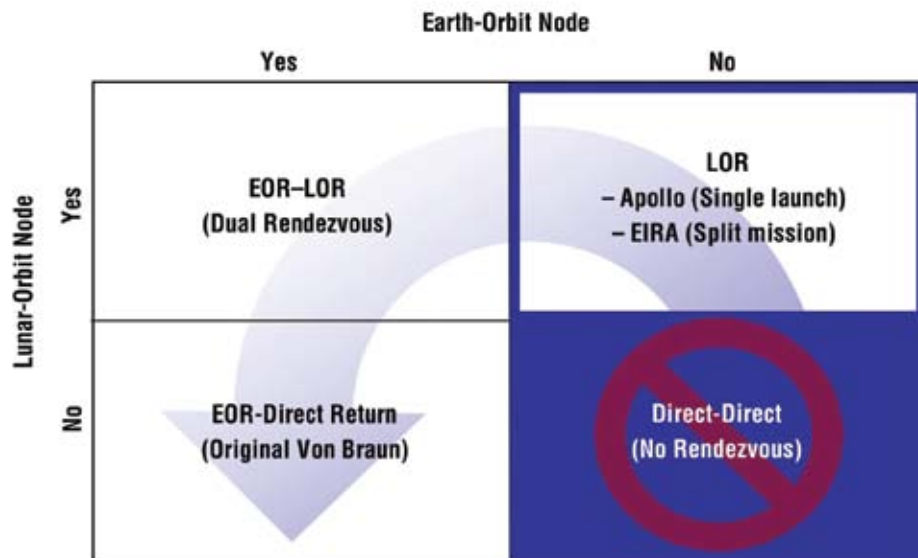

Figure 4-1. Lunar Mission Mode Taxonomy

This matrix becomes clearer when additional descriptions and certain historical lunar missions are added to the respective quadrants. The EOR-direct return mission (lower left-hand quadrant) was the mode favored by Wernher Von Braun early in the Apollo Program, while LOR (upper right-hand quadrant) was the mode eventually chosen. It became clear early in the ESAS analysis that the direct-direct mode (lower right-hand quadrant) would only be possible if the single LV it required had performance capability approaching 200 mT to LEO. Because no LVs of this size were contemplated for this study due to budget and ground operations constraints, direct-direct was eliminated as a mission mode. The three remaining mission modes (LOR, EOR-LOR, and EOR-direct return) will be analyzed in the following sections.

4.2.3 Analysis Cycle 1 Mission Mode Analysis

Mission mode analysis was performed in three cycles, with each cycle resulting in performance, cost, reliability, safety, and other Figures of Merit (FOMs) with which to compare the mission options. At the end of each analysis cycle, decisions were made to eliminate certain mission modes or to perform additional studies to further drive out the differences among the options. A baseline was chosen against which all design options could be compared. The baseline chosen by the ESAS team was a LOR split mission termed the ESAS Initial Reference Architecture (EIRA). The EIRA is explained in more detail in **Section 4.2.3.1, Definition of EIRA**.

For the initial analysis cycle, the EIRA mission was compared to EOR-LOR, EOR-direct return, and a variant of EOR-LOR that took the CEV to the lunar surface (similar to a direct return mission) but left the TEI propulsion in lunar orbit. Only the mission mode was varied in this first cycle. In all cases other than the original EIRA, the CEV was a 5.5-m diameter, 25 deg sidewall-angle capsule with 1,400 kg of radiation shielding. All post-TLI propulsion used pressure-fed LOX/methane engines and all lunar landers were expendable, two-stage configurations without airlocks.

The team generated mission performance analysis for each option (IMLEO, number of launches required, and launch margins), integrated program costs through 2025, safety and reliability estimates (probability of loss of crew (P(LOC)), and probability of loss of mission (P(LOM))), and other discriminating FOMs.

4.2.3.1 Definition of EIRA

Prior to beginning Analysis Cycle 1, the ESAS team created an initial reference architecture that would serve as the basis for initial trade studies. The team recognized that this EIRA would likely not be the optimum mission architecture, but would represent a solution that met all of the Ground Rules and Assumptions (GR&As) set forth for the study.

The EIRA timeline showed human crews returning to the Moon in 2018 with up to 7-day sortie missions continuing into the outpost deployment phase in 2020–2021. These initial sorties took a crew of four to any site on the lunar globe and included EVA on each day of the surface stay. The crew of four would explore the lunar surface in two teams of two crew members each, aided by unpressurized rovers for local mobility. Their payload complement would include science packages as well as exploration technology experiments. A minimum of two lunar sortie missions was planned for each year. The EIRA sortie mission is shown in **Figure 4-2**.

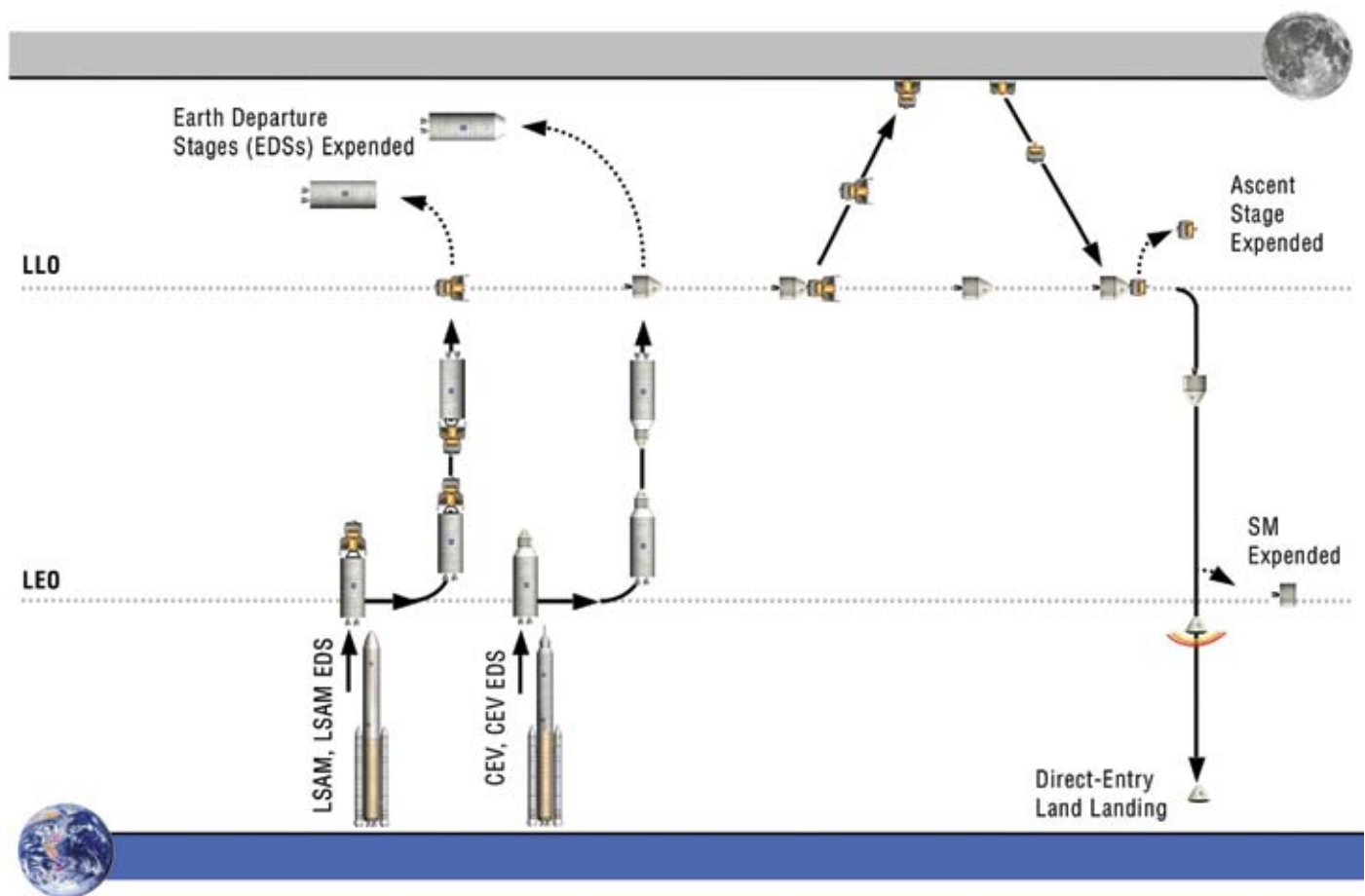

Figure 4-2. EIRA

Beginning in 2020 and extending into 2021, a series of dedicated cargo landers would deliver the elements of a permanent outpost. These elements, including a power system, habitat, and resource utilization equipment, would be deployed with the aid of robotic systems. Just prior to the arrival of the first crew, a “backup” ascent vehicle would be landed at the outpost to give the crew a redundant means of transportation off the lunar surface. The outpost would be in an Initial Operational Capability (IOC) and ready to receive the first crew by 2022.

The first outpost crew would arrive in 2022 for a 6-month rotation on the lunar surface. Subsequent crews would arrive every 6 months thereafter for the duration of the outpost’s operational lifetime. As steady-state operation of the outpost would also include a logistics delivery mission spaced midway through each crew rotation, the outpost would receive two crew landings and two logistics landings each year. Logistics flights could deliver up to 15 mT of cargo, including substantial resource utilization hardware and pressurized rovers to increase the crew’s mobility range. Outpost crews would continue scientific studies but would concentrate more on resource utilization and demonstration of Mars technologies and operational techniques. The outpost would remain in steady-state operation through at least 2030.

4.2.3.2 Trade Studies

Analysis Cycle 1 trade studies for the lunar architecture were intentionally limited to mission mode differences only. Using the EIRA mission as a baseline, the EIRA–LOR mission was compared to EOR–LOR, EOR-direct return, and a variant of EOR–LOR that would take the CEV to the lunar surface. In three of the four cases, the CEV was increased from a 5.0- to 5.5-m diameter, owing to parallel CEV volumetric and configuration studies that were ongoing at the same time. The mission mode differences also demanded slightly different splits of propulsive maneuvers among the flight elements to balance launch masses. The EOR–LOR variant performed the LOI maneuver using the lander’s descent stage, while all other options remained attached to the Earth Departure Stage (EDS) stage throughout the trans-lunar coast in order for that stage to perform LOI. The EIRA mission architecture and four options are highlighted in **Figure 4-3**.

This initial mission mode analysis therefore varied four parameters: the use of a lunar-orbit node (LOR versus a direct return from the Moon), the use of an Earth-orbit node (a “split mission” versus EOR), CEV capsules of varying shapes and volumes, and different TLI/LOI/TEI splits among propulsive elements.

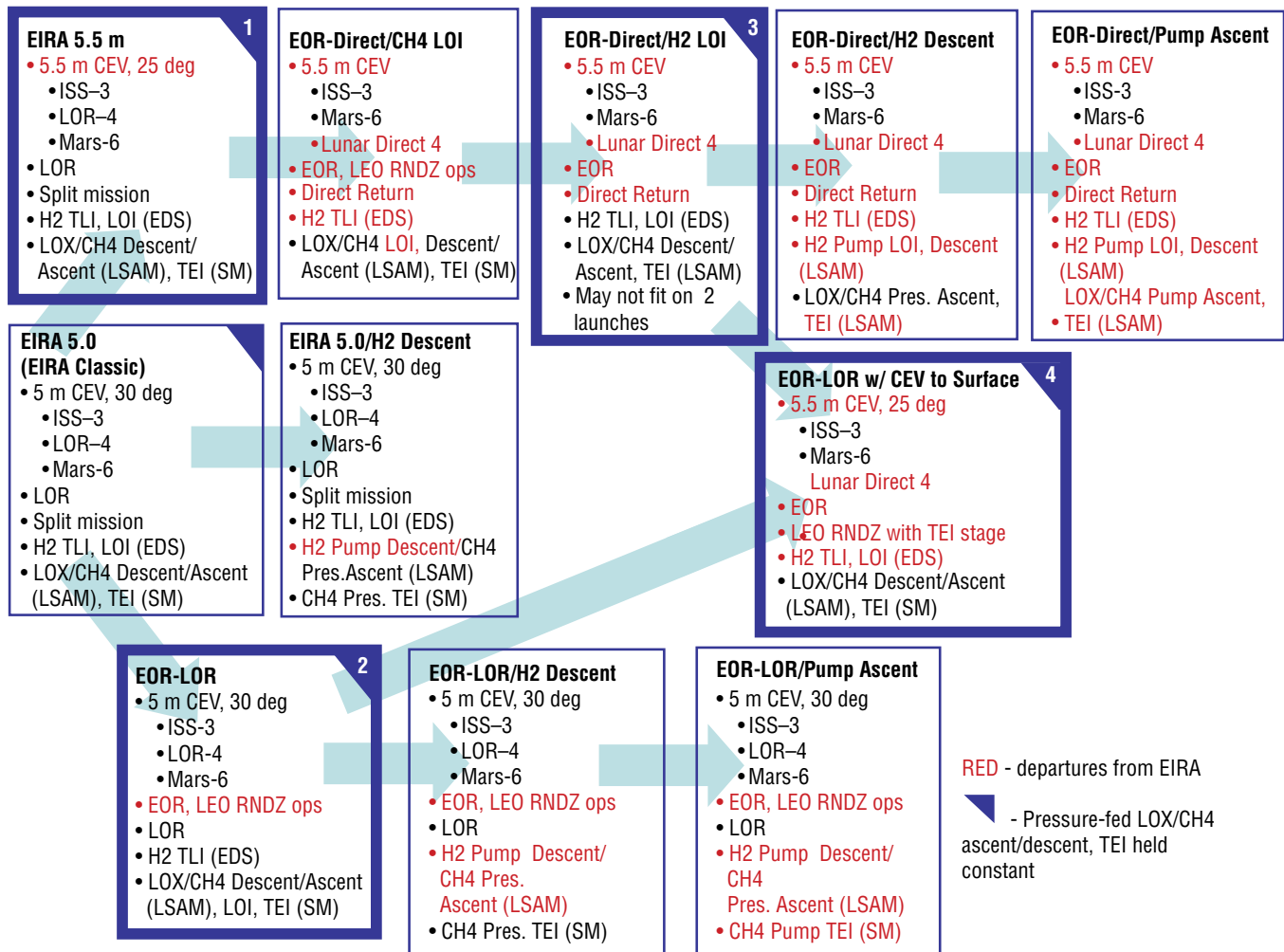

Figure 4-3. Analysis Cycle 1 Mission Architecture Flow

4.2.3.2.1 CEV and Lunar Surface Access Module (LSAM) Volume Studies

An understanding of the mass of the crew-carrying elements of the architecture, the CEV and the LSAM lunar lander, were fundamental to the analysis effort. Analytical tools used by the ESAS team required the pressurized volume of these vehicles as an input. The team investigated historical spacecraft volumes, drew on current human factors research, and involved current astronauts in the evaluation of full-scale mockups to produce recommendations. These results are presented in **Section 5, Crew Exploration Vehicle**.

CEV Task Analysis

The initial analysis to determine the minimum net habitable volume in the CEV assumed simultaneous suit donning/doffing of the Shuttle Advanced Crew Escape Suit (ACES) as the baseline. Assumptions were made as to the volume required for one crew member to don/doff the suit, and then this volume was multiplied by 4 for the CEV lunar mission case. This initial analysis also assumed that simultaneous suiting was a stand-alone activity and no other activities would happen while donning/doffing of suits was in progress. Therefore, additional habitable volume for these other tasks was not a consideration in the initial analysis.

A group of 15 astronauts, all with spaceflight experience, including Space Shuttle, Space Station, Mir, and Soyuz, unanimously agreed that simultaneous suit donning/doffing was operationally inefficient, and that assisted suiting is a faster and more efficient use of available volume. This group also agreed the suiting would never be the single activity occupying the entire crew at the same time.

A low-fidelity mockup of the Cycle 4 CEV volume was built at JSC and evaluated by this group of experienced astronauts in a completely subjective fashion to determine if the net habitable volume, as laid out in the point solution of internal layout of systems and seats, seemed sufficient for zero-g activities based on their collective experiences. The measured net habitable volume of the mockup was 14.9 m³, and there was unanimous agreement that this net habitable volume was sufficient. At this point in the design cycle, the group was unwilling to recommend any volume number smaller than that measured in this mockup—given the uncertainties of where and how systems/seats would be configured and how much of the pressurized volume they would occupy, as well as uncertainties in the operational tasks required for lunar transit missions and the tools necessary to execute those tasks.

4.2.3.3 Performance

The first ESAS architecture design cycle evaluated the performance of four competing human lunar mission architectures. Data generated from this analysis, including vehicle mass properties, mission critical events, and number and type of launches, was subsequently used to inform cost, safety, reliability, and other related FOM comparisons. The first architecture alternative was a mission consisting only of vehicle rendezvous and docking occurring in LLO. This mission mode was selected as the EIRA against which other architectures were measured. The next architecture was a variant from the reference in that the initial rendezvous between the CEV and the LSAM occurred not in lunar orbit but in Earth orbit. Another variant also included vehicle rendezvous and docking in Earth orbit, but the vehicles landed directly on the Moon after leaving LEO and returned directly to Earth. The fourth and final architecture was a variant on the second in that, instead of having two dedicated Crew Modules (CMs) (one for transit to and from the Moon and one for lunar operations), this architecture used a single CM for the entire mission.

As introduced in **Section 4.2.2, Mission Mode Option Space**, mission architectures are identified according to the following nomenclature.

- LOR EIRA;
- EOR–LOR;
- EOR-direct return; and
- EOR–LOR with CEV-to-surface.

Subsequent sections of this report describe the performance, operation, and other salient features of these architectures.

4.2.3.3.1 EIRA LOR

The assumed mission mode for the EIRA is a 2-launch “split” architecture with LOR, wherein the LSAM is predeployed in a single launch to LLO, and a second launch of the same vehicle delivers the CEV and crew in lunar orbit, where the two vehicles initially rendezvous and dock. The entire crew then transfers to the LSAM, undocks from the CEV, and performs a descent to the surface. The CEV CM and SM are left unoccupied in LLO. After up to 7 days on the lunar surface, the LSAM returns the crew to lunar orbit and docks with the CEV, and the crew transfers back to the CEV. The CEV then returns the crew to Earth with a direct-entry-and-land touchdown while the LSAM is disposed of on the lunar surface. This mission mode is illustrated in **Figure 4-4**.

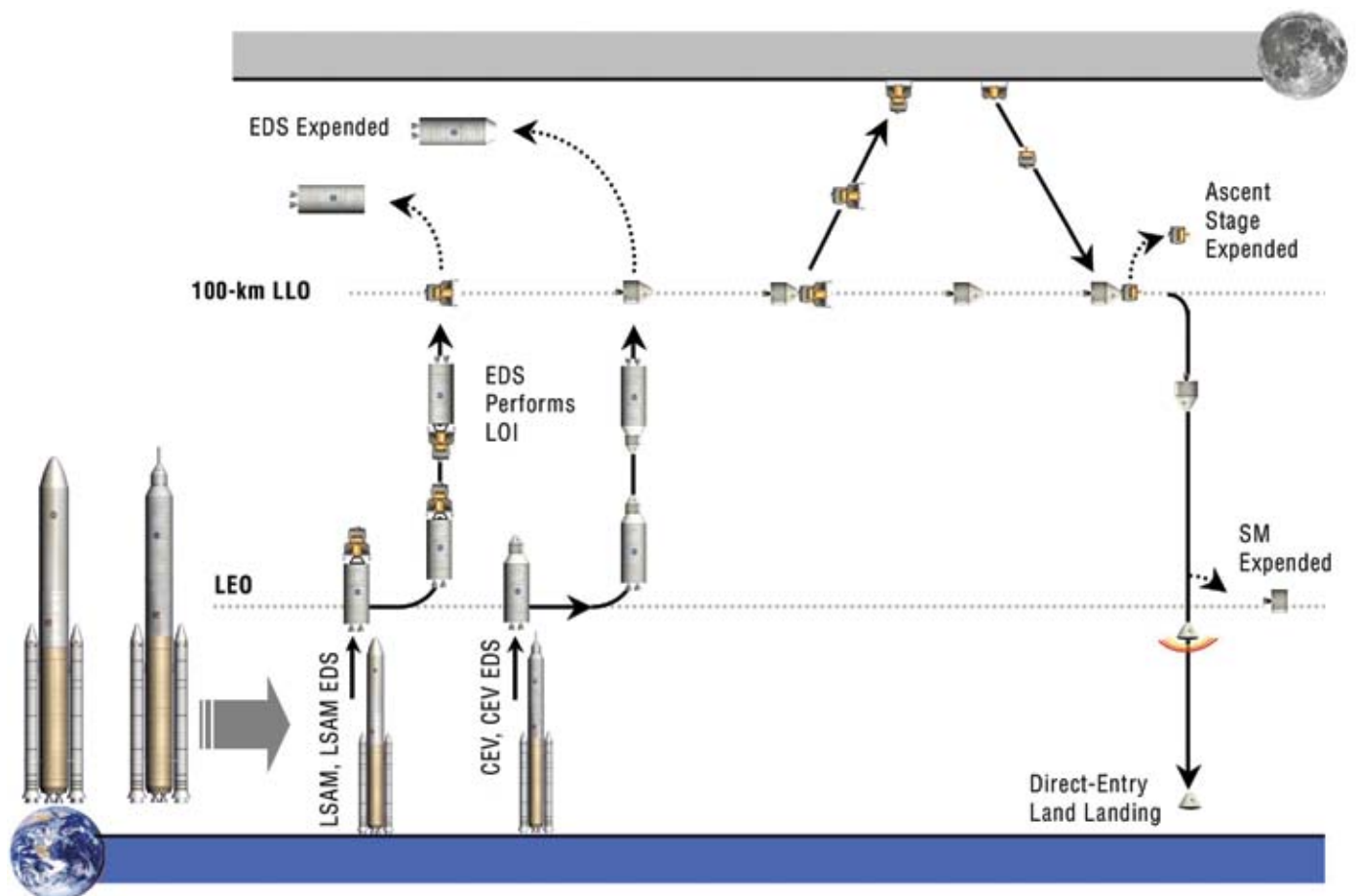

Figure 4-4. EIRA (Analysis Cycle 1)

The Analysis Cycle 1 CEV assumed in the EIRA is a four-person capsule with a base diameter of 5.0 m and 30-deg sidewall angle, providing a total pressurized volume of 22.4 m³. The CEV provides 47 crew-days of nominal life support capability and includes 5 g/cm² of supplemental High-Density Polyethylene (HDPE) shielding on the capsule sidewalls and ceiling for radiation protection. The EIRA CEV SM is an unpressurized cylinder containing the primary vehicle propulsion and power generation systems. An integrated pressure-fed oxygen/methane propulsion system provides 1,772 m/s of orbital maneuvering and reaction control delta-V. For the EIRA, these maneuvers include rendezvous and docking with the LSAM in LLO, a 5-deg contingency ascent plane change, the TEI burn, and mid-course corrections. The SM includes two 22.2-kN (5-klbf) pressure-fed main engines and twenty-four 445-N (100-lbf) reaction control thrusters. The combined CEV mass in LEO following launch is 22,909 kg, with 9,623 kg allocated for the CM and 13,286 kg for the SM. The assumed LV and EDS for the EIRA can deliver a net payload of 29,100 kg to LLO.

The Analysis Cycle 1 LSAM transports four crew from LLO to the lunar surface, supports the crew for up to 7 days on the Moon, and returns the crew to the CEV in LLO. The assumed LSAM configuration includes a separate ascent and descent stage similar to the Apollo LM, with the ascent stage containing the LSAM crew cabin and mounted on top of the descent stage. As in Apollo, the nominal EVA mode is to fully depressurize the ascent stage crew cabin, open the hatch, and egress the vehicle. The crew cabin is a horizontal short cylinder providing 29.2 m³ of pressurized volume. Propulsion for the ascent stage is similar to the CEV SM in that it uses the same propellants (oxygen/methane) and main/reaction control engines. This propulsion includes two 22.2-kN (5-klbf) pressure-fed main engines and sixteen 445-N (100-lbf) reaction control thrusters to perform 1,882 m/s of ascent and orbital maneuvering delta-V. The total ascent stage mass in LEO is 9,898 kg. The LSAM descent stage provides powered descent for the crew and ascent stage from LLO to the lunar surface. The propulsion system for the descent stage is similar to the CEV SM and includes four 22.2-kN (5-klbf) pressure-fed main engines and sixteen 445-N (100-lbf) reaction control thrusters to perform 1,917 m/s of powered descent and attitude control delta-V. The descent stage also carries 500 kg of mission payload, such as rovers and science equipment, to the surface. The descent stage wet mass is 18,010 kg, and the combined LSAM mass including the ascent stage is 27,908 kg. Since the same EDS used to deliver the CEV to lunar orbit is used for the LSAM, the net LSAM mass limit with 10 percent EDS performance reserve is 29,100 kg. Both the CEV and LSAM have positive mass margins relative to the EDS performance limit, thus making the EIRA a valid 2-launch mission.

The Analysis Cycle 1 EIRA also includes analysis of a larger-volume variant of the CEV. This larger CM assumes a base diameter of 5.5 m and 25-deg sidewall angle to provide a total pressurized volume of 39.0 m³. With this extra volume, the CM mass increases from 9,623 kg to 11,332 kg, the SM mass increases to 14,858 kg, and the total CEV mass increases to 26,190 kg. The total CEV mass is still within the performance capabilities of the EDS.

4.2.3.3.2 EOR-LOR Architecture

The EOR-LOR architecture (**Figure 4-5**) is functionally similar to the EIRA, with the primary difference that the initial CEV-LSAM docking occurs in LEO rather than LLO. Whereas the EIRA incorporated two smaller EDSs in two launches to deliver the CEV and LSAM to the Moon, the EOR-LOR architecture divides its launches into one launch for a single, large EDS and a second launch for the CEV, crew, and LSAM. The combined CEV and LSAM dock with the EDS in Earth orbit, and the EDS performs TLI. Another difference between the EIRA and EOR-LOR architectures is that the EDS performs LOI for the EIRA. Due to launch performance limitations of the single EDS with EOR-LOR, LOI is instead executed by the CEV for optimum performance. Once the CEV and LSAM reach LLO, this mission mode is identical to the EIRA.

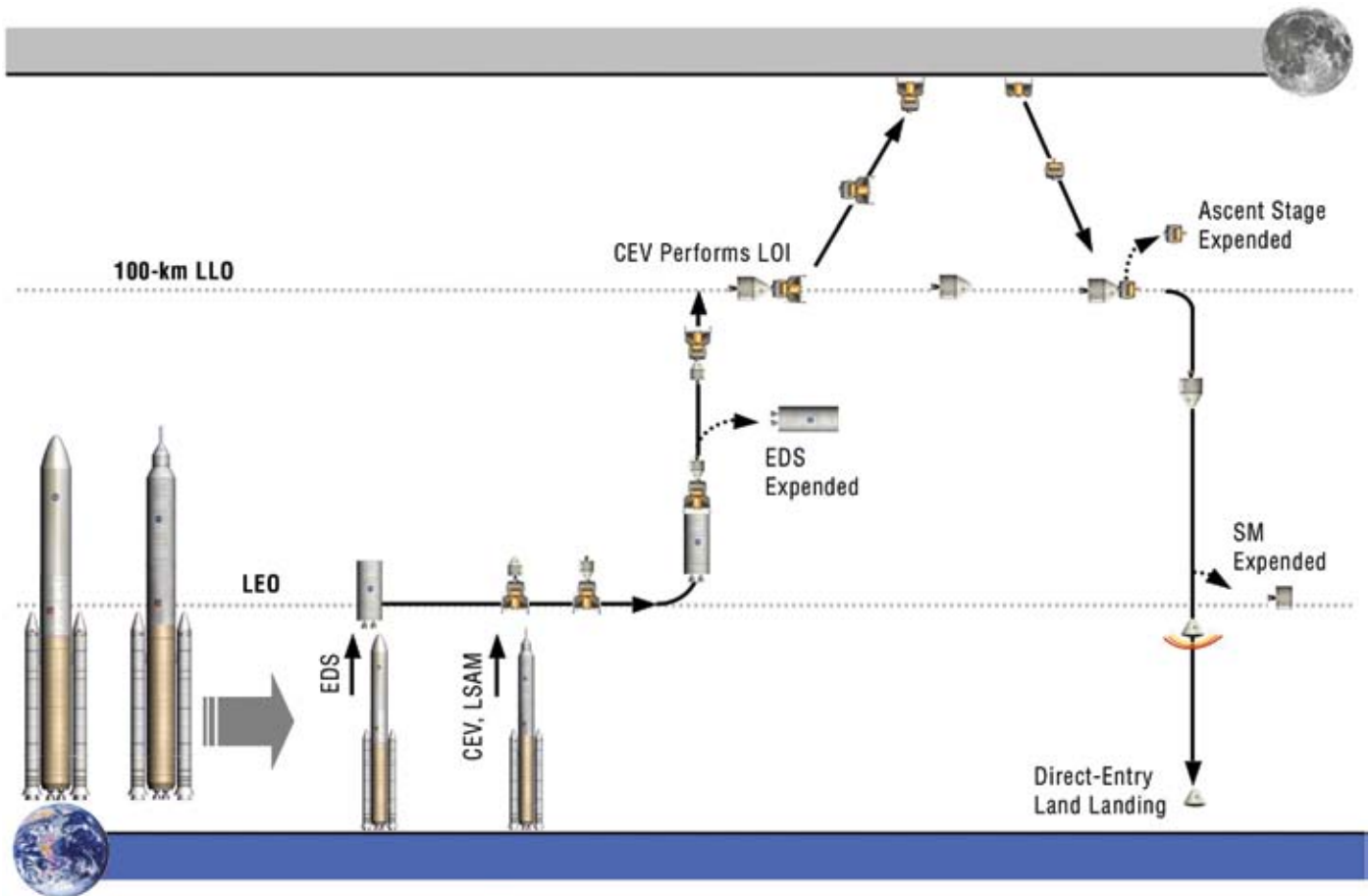

Figure 4-5. EOR-LOR Architecture (Analysis Cycle 1)

The same EIRA 5.0-m CEV CM has been retained for this architecture with one minor modification. The EOR–LOR CEV nominally requires 53 crew-days of life support capability while the EIRA requires 47 crew-days. This is due to the additional rendezvous and docking maneuvering required in LEO with EOR–LOR, whereas the EIRA is a direct injection mission, and the CEV EDS performs TLI within a few hours after reaching orbit.

The SM is also functionally similar to the EIRA with a few notable exceptions. For this architecture, the CEV is needed to perform the LOI maneuver to fit within the EDS TLI capabilities. As the LSAM is attached to the CEV at this point, the required propellant quantity in the SM is significantly higher than the EIRA. The EOR–LOR SM includes four 22.2-kN (5-klbf) pressure-fed main engines to perform 3,161 m/s of delta-V. Major CEV maneuvers in this architecture include transposition and docking with the LSAM in LEO, rendezvous and docking of the combined CEV and LSAM with the EDS, LOI, a 5-deg contingency ascent plane change, TEI, and return mid-course corrections. The SM mass at launch is 49,750 kg, and the total CEV mass is 59,445 kg combined with the CEV CM. This compares to 22,909 kg for the EIRA total CEV mass.

No modifications to the EIRA LSAM are assumed for this architecture. Therefore, the combined LSAM and CEV mass prior to TLI, including docking provisions and subtraction of LEO rendezvous propellant from the CEV, is 83,000 kg. The EDS assumed in this architecture can inject 85,600 kg to TLI, while the CLV can lift 91,300 kg to LEO.

4.2.3.3.3 EOR-Direct Return Architecture

The EOR-direct return architecture analyzed in Analysis Cycle 1 is a significant departure from the previous two options in that there are no rendezvous maneuvers needed to complete the mission once the CEV and LSAM (with no crew volume) depart LEO. LOR architectures rely on leaving some part of the return vehicle (CEV) in LLO while a dedicated lunar landing system transports the crew between lunar orbit and the lunar surface. The EOR-direct return architecture instead carries the entire Earth return system down to the lunar surface, thereby greatly simplifying the mission. Where the previous architectures required two crew cabins (the CEV and LSAM ascent stage crew cabins), the crew spends the entire mission in a single crew cabin (the CEV). However, this flexibility comes at the cost of added architecture mass in LEO. Using the same propulsion assumptions as in the LOR alternatives (pressure-fed oxygen/methane), this architecture requires a third heavy-lift launch to perform each mission.

The assumed mission mode for the EOR-direct return architecture (EIRA) is a 3-launch “all-up” architecture with EOR. Due to the excessive CEV–LSAM mass, each mission requires two EDSs to deliver the vehicles to LLO. The EDSs are launched prior to the crew and automatically docked in LEO. After the crew, CEV, and LSAM launch in the third launch, the vehicles dock to the EDSs and perform TLI. The first EDS is exhausted prior to completing TLI and is separated and disposed. The second EDS completes TLI and performs LOI 4 days later. Rather than undocking from the CEV and leaving the vehicle unoccupied in lunar orbit, the CEV and LSAM both land on the Moon. After up to 7 days on the lunar surface, the CEV returns the crew directly back to Earth with a direct-entry-and-land touchdown. This mission mode is illustrated in **Figure 4-6**.

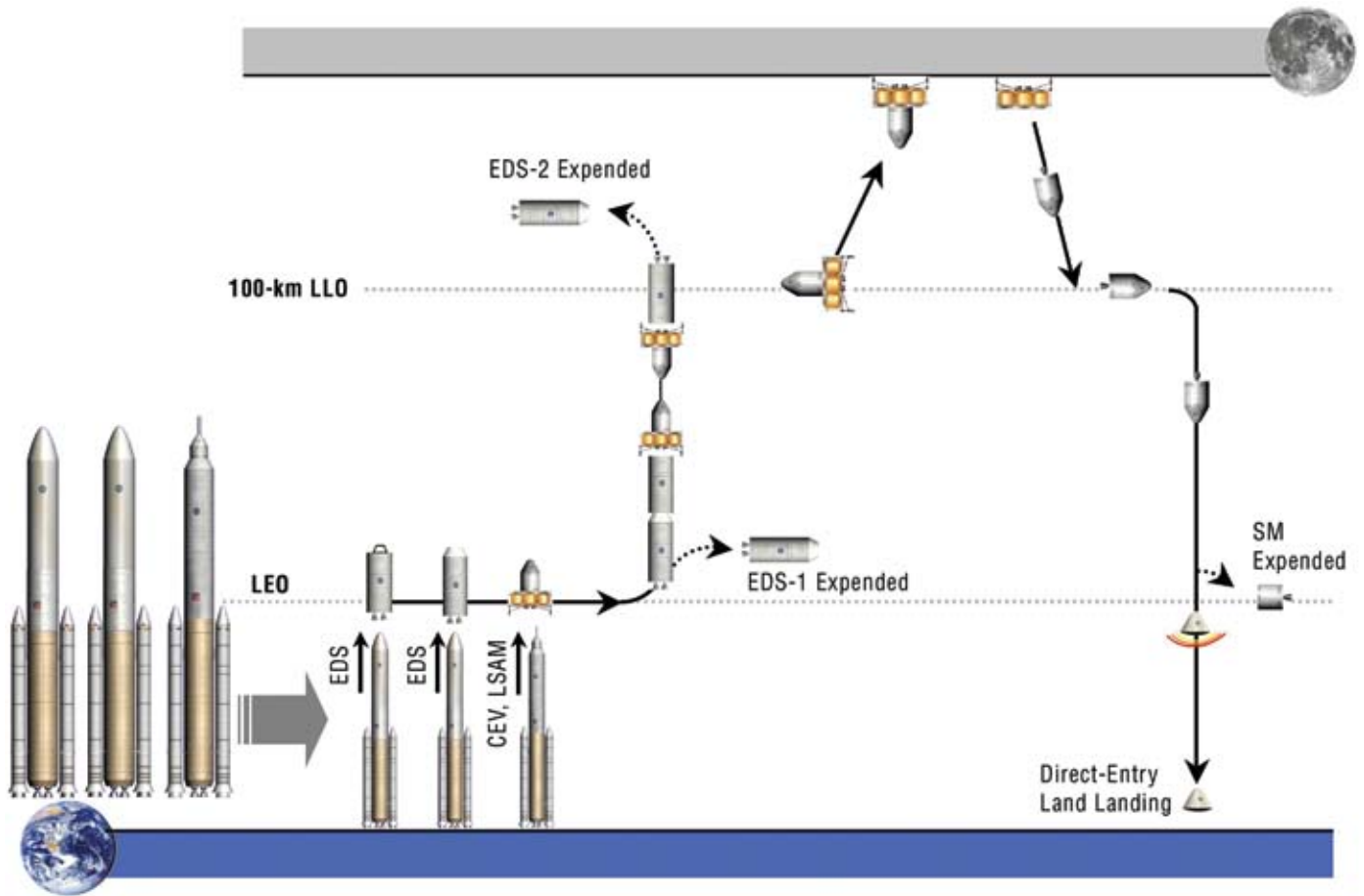

The larger 5.5-m, 25-deg sidewall angle CEV introduced in the EIRA description is used for analyzing the EOR-direct return architecture. This vehicle was needed to provide the necessary habitable volume and floor space for operating on the lunar surface for up to 7 days. The configuration provided 39.0 m³ of pressurized volume. Other modifications include additional displays and controls for landing on and ascending from the lunar surface, a full-cabin depressurization capability for multiple surface EVAs, and additional life support capability for additional crew time spent in the CEV CM. The mass of the EOR-direct return CM is 11,653 kg at launch.

Figure 4-6. EOR-Direct Architecture (Analysis Cycle 1)

EOR-direct return combines the ascent function of the EIRA LSAM and the TEI function of the EIRA SM into the CEV. Three 44.5-kN (10-k lbf) pressure-fed main engines and sixteen 445-N (100-lbf) reaction control thrusters perform 2,874 m/s of ascent, TEI, and attitude control delta-V. The CEV SM mass at launch is 29,642 kg, compared to 14,858 kg for the 5.5-m EIRA SM.

The LSAM in this architecture functionally only includes the descent stage from the EIRA LSAM, as the ascent stage functionality has been moved to the CEV CM and SM. The EOR-direct return LSAM performs powered descent for the crew and CEV from LLO to the lunar surface. The propulsion system for the descent stage uses the same propellants and engines as the CEV SM. It includes five 44.5-kN (10-klbf) pressure-fed main engines and sixteen 445-N (100-lbf) reaction control thrusters to perform 2,042 m/s of LEO rendezvous, powered descent, and attitude control delta-V. The LSAM also carries the same 500 kg of mission payload as in the EIRA. This produces an LSAM wet mass of 47,437 kg, a combined stack mass including the CEV of 88,732 kg for launch, and a trans-lunar-injected mass of 87,235 kg. Since the large EDS used in the EOR-LOR architecture can only deliver 54,700 kg to LLO, a second EDS (and third launch) is required to execute this mission. Adding a second EDS increases the net payload delivery capability to 121,000 kg to LLO, which is well above the CEV-LSAM trans-lunar injected mass.

4.2.3.3.4 EOR-LOR with CEV-to-Surface Architecture

The fourth and final Analysis Cycle 1 architecture is a hybrid between the previous two options. It combines the LOR aspect of the EOR-LOR architecture and single crew volume of the EOR-direct return architecture. Rather than leaving the CEV CM and SM behind in LLO, this architecture separates the two elements, leaves only the SM behind, and uses the CM to operate on the lunar surface. However, as in the EOR-direct return architecture, the combined mass of the CEV and LSAM exceeded the performance capabilities of a single EDS, thus adding a third launch to each mission.

The EOR-LOR with CEV-to-surface architecture (**Figure 4-7**) operates identically to the EOR-direct return mode up to the point of powered descent. At this point, the CEV separates from the LSAM, and the CM separates from the SM. Using a docking module beneath the CM aft heat shield, the CM returns to the LSAM and docks to the ascent stage. The LSAM then transports the crew to the lunar surface for the nominal surface stay (up to 7 days). Once complete, the ascent stage returns the crew and CEV CM to LLO, the vehicles separate, and the CM docks to the SM. Finally, just as in the EOR-LOR architecture, the SM performs a TLI burn and the crew returns to Earth.

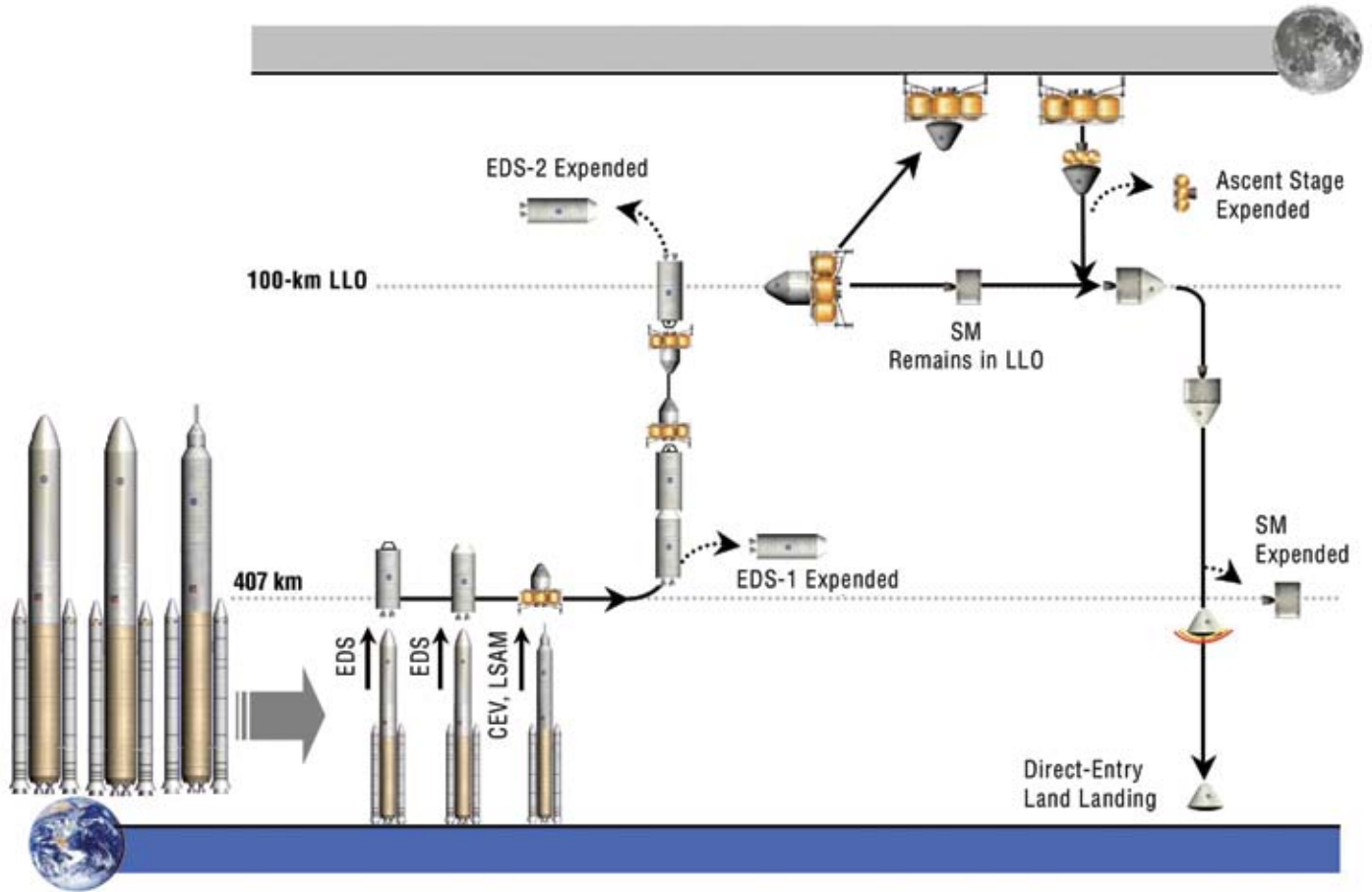

The 5.5-m CEV CM in this architecture is identical to the EOR-direct return architecture, with the addition of four extra crew-days of life support capability. A docking module has also been added to the CEV to facilitate docking to the ascent stage. The SM is functionally similar to the EIRA in that its primary maneuvering capability is for TEI. Additional avionics are included on the vehicle for Command and Control (C&C) while the CM and SM are separated. A single 44.5-kN (10-klbf) main engine and twenty-four 445-N (100-lbf) reaction control thrusters perform 1,612 m/s of TEI and orbital maneuvering delta-V. The masses for the CEV CM, docking module, and SM are 11,871 kg, 1,153 kg, and 11,701 kg, respectively, for a total CEV mass of 24,725 kg at launch.

The LSAM consists of pressure-fed oxygen/methane ascent and descent stages for transporting the CM between LLO and the lunar surface. The descent stage is identical to the EOR-direct return descent stage in number of engines and total delta-V; however, the propellant loading is different due to the lower landed mass. The descent stage's total launch mass is 37,053 kg. The ascent stage consists of two pressure-fed oxygen/methane engines at 44.5 kN (10 klbf) per engine and sixteen 445-N (100-lbf) reaction control thrusters. The total delta-V required is 1,882 m/s for a total ascent stage mass of 14,897 kg.

Figure 4-7. EOR-LOR with CEV-to-Surface Architecture (Analysis Cycle 1)

Total mass at TLI for the CEV and LSAM is 75,635 kg. Since the lunar orbit delivery capability of a single EDS is only 42,700 kg, a second EDS and third mission launch is required to deliver the required mass to the Moon. The EDS performance here is less than in the previous architecture (the performance was 54,700 kg) due to the addition of an LOI plane change on arrival. All LOR options require a plane change to properly align the parking orbit plane for anytime ascent off the surface. As direct return mission modes do not require a rendezvous to return to Earth, this plane change is unnecessary.

4.2.3.3.5 Architecture Performance Comparison

Figure 4-8 provides a normalized total mass comparison of the four architecture modes under consideration in Analysis Cycle 1. As each architecture operates the EDS differently, comparing the alternatives using traditional metrics such as IMLEO is somewhat misleading. For example, the EOR-LOR architecture uses the CEV to perform LOI while the other architectures use the EDS. Also, the latter two architectures that take the CEV to the lunar surface require three launches per mission while the others require two. A more meaningful comparison would be of the margin or vehicle growth potential each architecture provides or a “normalized” IMLEO comparison that assumes the same EDS functionality and number of launches per mission for each option.

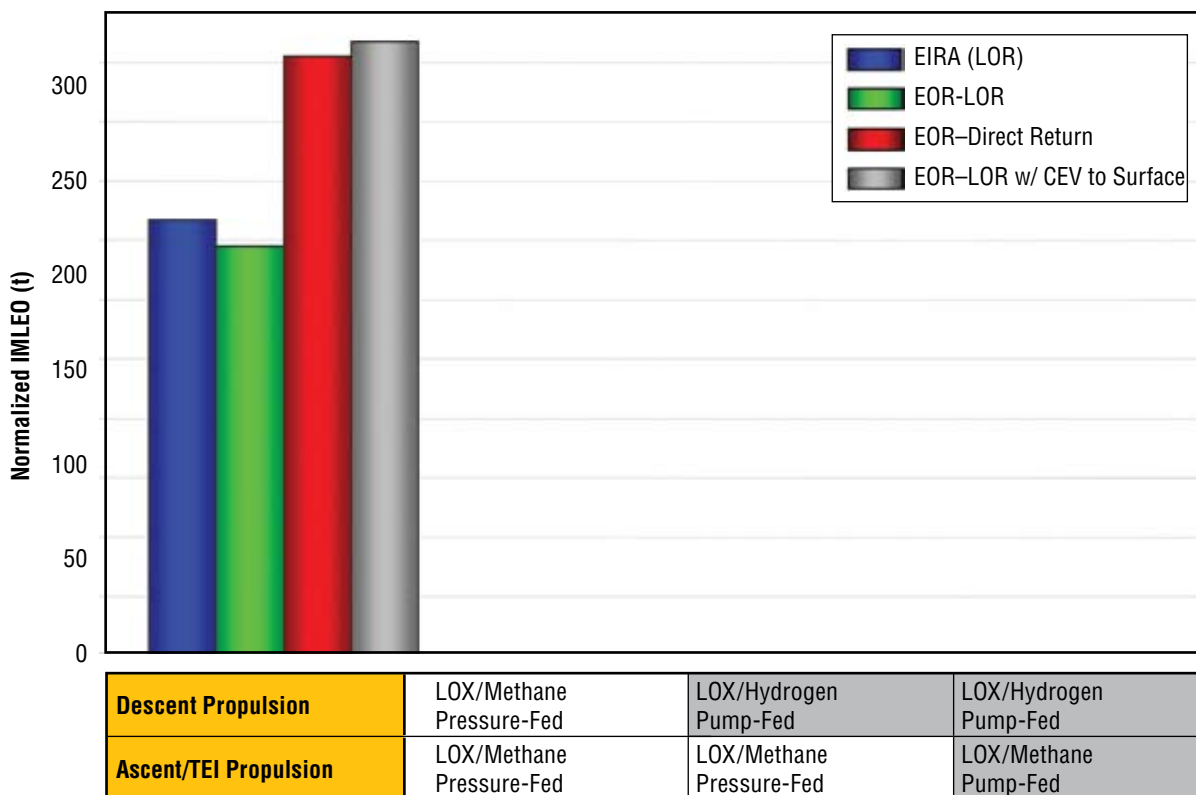

Figure 4-8. Analysis Cycle 1 Normalized IMLEO Comparison

This analysis assumes the EDS is used to perform TLI and LOI in each architecture and that each is a 2-launch solution. Rather than using a specific EDS mass in LEO, as supplied by the launch vehicle analysts, the EDS mass is estimated for the specific payload using a mass fraction, specific impulse, and required delta-V. Therefore, while each bar in the chart does not correspond to the mission’s actual mass in LEO, the relative comparison between the four alternatives is correct. As expected, the EIRA has a slightly higher normalized IMLEO than

EOR–LOR due to its having two EDSs instead of one. EOR–LOR has the lowest normalized IMLEO, while architectures where the CEV goes to the lunar surface (the latter two) are roughly 50 percent higher. The EOR-direct return architecture is heavily penalized for taking the CM to the surface when using pressure-fed oxygen/methane propulsion. Surprisingly, the EOR–LOR with CEV-to-surface architecture has the highest overall normalized IMLEO. One might suspect that eliminating the ascent stage crew cabin and leaving the CEV SM in LLO would at least negate the cost of taking the heavy CM to and from the surface. However, the assumed mission design selected for its positive crew safety aspects requires a relatively large plane change at LOI to align the parking orbit for anytime ascent. The vehicles also require additional propellant and mating interfaces to facilitate the intricate docking and undocking sequences in LLO. These factors cause a significant increase in the required EDS propellant and drive-up the architecture’s normalized IMLEO. Later design cycles examined more advanced descent, ascent, and TEI propulsion options to reduce mass and possibly eliminate launches.

4.2.3.4 Figures of Merit

The performance of the baseline EIRA mission was documented in two forms as inputs for the ESAS team. The team was given detailed subsystem mass breakdowns for each of the vehicles in the architecture, each with an estimate for minimum, most likely, and maximum mass as well as an explanation for any subsystem that deviated from the EIRA baseline. The team was also given a summary of mission events, including details for critical events such as engine burn times for major propulsive maneuvers.

The team generated integrated life cycle program costs through the year 2025 that were compared against the EIRA baseline mission. Likewise, the team developed estimates for the P(LOC) and the P(LOM). Detailed safety and reliability analyses are presented in **Section 8, Risk and Reliability**, and detailed cost analyses are presented in **Section 12, Cost**.

Table 4-2 summarizes the performance, cost, safety, and reliability of Analysis Cycle 1 mission options. IMLEO mass was normalized to account for the fact that different mission modes split propulsive delta-V across the upper stages of LVs and descent stages of landers in different ways. The original EIRA using the 5.0-m diameter CEV and the EIRA with a 5.5-m diameter CEV were analyzed for cost differences only.

	Design Cycle 1—Common Assumptions			
	Normalized IMLEO (mT)	Integrated Cost Delta	P (LOC)	P (LOM)
EIRA	183.9	0B	0.07	0.19
#1 EIRA 5.5 m		+1.7B		
#2 EOR–LOR	172.5	+3.0B	0.07	0.20
#3 EOR-Direct Return	252.6	+7.1B	0.04	0.21
#4 EOR–LOR w/CEV-to-Surface	258.9	+18.4B	N/A	N/A

Table 4-2. Analysis Cycle 1 Architecture Options Performance, Cost, and Risk Comparison

The ESAS team also assessed FOMs other than cost, risk, and performance in order to more completely characterize all major trade studies. FOMs were selected, as described in **Section 2, Introduction**, to be relatively independent and comprehensive and were described by direct measures as well as proxy parameters. Extensibility and flexibility were characterized in terms of lunar mission flexibility, Mars mission extensibility, extensibility to other exploration destinations, commercial extensibility, and national security extensibility. Programmatic risk, separate from safety and mission success, was characterized in terms of technology development risk, cost risk, schedule risk, and political risk. Analysis Cycle 1 strengths and weaknesses relative to the FOMs are shown in **Table 4-3**.

Table 4-3. Analysis Cycle 1 Mission Architecture FOMs

Cycle 1 Architecture	Description	Discriminating FOMs	
		Advantages	Disadvantages
EIRA	5-m, 30-deg CEV; LOR split mission; LOX/H ₂ TLI, LOI; CH ₄ Descent, Ascent, TEI		
EIRA 5.5 Split Mission	5.5-m, 25-deg CEV; LOR split mission	<ul style="list-style-type: none"> • No EOR (same as EIRA). 	<ul style="list-style-type: none"> • 2×LOR required for mission success; • 1 critical LOR required for crew survivability; and • No “Apollo 13” lifeboat capability.
EOR–LOR	5.5-m, 25-deg CEV; EOR rendezvous (“all-up”), LOI performed by SM (LOX/CH ₄)	<ul style="list-style-type: none"> • One less propulsion stage; • One fewer engine; and • “Apollo 13” backup habitat capability available outbound. 	<ul style="list-style-type: none"> • Greater number of rendezvous required (2×EOR (transposition and docking, dock w/EDS) and 1×LOR) required for mission success; • Critical LOR required for crew survivability; and • Large element rendezvous and docking in LEO.
EOR-Direct	5.5-m, 25-deg CEV; CEV goes direct-to-surface, CEV direct return from surface; 2×EDS stages required for this baseline prop option	<ul style="list-style-type: none"> • Fewer flight elements (one less crew cabin, one less propulsion stage); • Two fewer vehicle-to-vehicle interfaces; • No LLO rendezvous; no rendezvous required for crew survivability; • Less overall delta-V; and • Greater cargo mass to surface. 	<ul style="list-style-type: none"> • No flight experience with direct return missions; • 2×EDS stages required for this baseline prop option (three launches per mission); • 2×EOR (uncrewed large-element EDS-to-EDS and EDS-to-LSAM) required for mission success; • Initial CEV development scarred for lunar surface missions; • More sensitive to CEV and returned mass growth; • Surface dust control in CEV; • No “Apollo 13” lifeboat capability; and • Ascent stage has less (or no) commonality with CEV ISS SM.
EOR–LOR w/ CEV-to-Surface	5.5-m, 25-deg CEV; CEV goes direct-to-surface, CEV direct return from surface via LOR rendezvous with SM; 2×EDS stages required for this baseline prop option	<ul style="list-style-type: none"> • Fewer flight elements (one less crew cabin); and • One less engine, one less vehicle-to-vehicle interface. 	<ul style="list-style-type: none"> • 2×EDS stages required for this baseline prop option; • Greater number of rendezvous required—2×EOR (large element uncrewed EDS to EDS, LSAM to EDS) + 2×LOR (CEV to LSAM, crew-survivability critical, complex CEV to SM); • Three launches per mission; • Initial CEV development scarred for lunar surface missions; • Surface dust mitigation on CEV; greater sensitivity to mass growth; • No “Apollo 13” lifeboat capability; and • More sensitive to CEV and returned mass changes.

4.2.3.5 Findings and Forward Work

This initial analysis of mission architecture modes collapsed the option space to a 2x2 matrix that compared Earth-orbit operations and lunar-orbit operations. Within that matrix, the option with no operations in either LEO or LLO (the “direct-direct” mission mode) was eliminated due to its requiring a single launch of more than 200 mT to LEO. A baseline LOR mission architecture was established and LOR, EOR–LOR, and EOR-direct options were compared to it, albeit limited to variations of mission mode only. The CEV for each option was similar, varying only in diameter from 5.0 m to 5.5 m. All options carried 1400 kg of supplemental radiation protection. For each common propulsive event (LOI, lunar descent, lunar ascent, and TEI), propulsion type and technology were held constant across the architectures.

Based on the above assumptions, LOR mission modes result in the lowest IMLEO, lowest cost, and fewest launches. Direct return missions had the lowest P(LOC) but required three launches, resulting in higher P(LOM). The analysis showed that certain mission modes performed poorly using the baseline architecture assumptions, which led the team to investigate more optimized propulsion type and technologies in proceeding analysis cycles. Higher efficiency lander propulsion could reduce direct return options to two launches, thus enabling better comparison of the mission mode.

The poorest performing option investigated in Cycle 1 was EOR–LOR with CEV-to-surface. This option was eliminated from further considerations due to having the highest IMLEO, the highest P(LOM), and the highest cost.

Analysis Cycle 2 was targeted at optimizing mission mode performance with propulsion technology changes, including LOX/H₂ descent stages and pump-fed LOX/CH₄ ascent stages. Radiation shielding, which accounts for 15 percent of the CEV mass, would be further studied, as would the CEV configuration for surface-direct missions and airlocks for surface operations.

4.2.4 Analysis Cycle 2 Mission Mode Analysis

Initial mission mode analysis results pointed to the need to vary both propulsion technology and spacecraft subsystems to assess the sensitivity of the mission mode to both the linear and exponential variables of the rocket equation. The ESAS team noted that the greatest leverage could be found in CEV systems that necessarily travel round-trip from launch to landing and propulsion systems that occur at or near the end of the mission’s series of propulsive events.

The variables examined in the second design cycle included the mass of supplemental radiation shielding applied to the CEV, the split of delta-V maneuvers among propulsive stages, higher-efficiency propulsion systems, and the application of airlocks and split volumes to surface landers. The goal of the analysis was to eliminate all “3-launch solutions” and better optimize each of the mission mode options. In particular, this cycle sought to determine the feasibility of the EOR-direct return mission mode. This particular mission mode was the most stressing to the CEV design, as it required a single crew compartment to perform planetary landing, surface habitation, and planetary ascent functions in addition to all the functions required for an LOR mission.

4.2.4.1 Trade Studies

Analysis Cycle 2 began an in-depth analysis of CEV supplemental radiation shielding and of CEV and LSAM propulsion technology. The ESAS team chose to first trade spacecraft variables that offered the greatest IMLEO savings based on both mass sensitivities and the need to better understand these variables. Mass sensitivities for the three mission modes, as shown in **Table 4-4**, measure the “partial differential” effect of increasing specific vehicle inert masses as a function of the overall system IMLEO mass. Such tables are useful in identifying where the greatest mass savings can be gained via technology investment or increased engineering certainty.

Table 4-4. Lunar Architecture Mass Sensitivities by Mission Mode

IMLEO Mass Vehicle Mass for:	LOR (EIRA)	EOR-LOR	EOR-Direct
CEV CM	6.1	6.4	14.7
CEV SM	5.1	5.4	12.3
Ascent Stage	8.8	10.1	
Descent Stage	4.8	5.5	4.6
Round-Trip Cargo	12.1	13.4	14.7

Based on the mass sensitivities, the greatest IMLEO mass leverage comes from mass reductions in the LSAM ascent stage, round-trip cargo, or (for the EOR-direct return mode only) the CEV CM itself. Based on this knowledge, the ESAS team undertook a critical study of the CEV CM mass and, in particular, the approximate 1,800 kg of supplemental radiation shielding that was being carried round-trip. Additionally, the LSAM ascent and descent stages offered opportunities to decrease IMLEO through the use of higher specific impulse (Isp) propulsion systems.

4.2.4.1.1 CEV Radiation Protection

The CEV CM will be the primary crew cabin for the majority of the lunar mission. It will contain the crew during launch, Earth-orbital operations, trans-lunar cruise, and in lunar orbit. For LOR missions, the crew will transfer to the LSAM for the duration of surface operations, but will return to the CM for additional lunar orbit operations, trans-Earth coast, and Earth entry. For direct return missions, the crew will remain in the CM for lunar descent, surface operations, and ascent. At a minimum, the crew will spend 9 days in the CM beyond the protection of Earth's magnetosphere in the interplanetary radiation environment.

Ionizing radiation is a major health hazard everywhere in space and on all planetary and satellite surfaces. Galactic Cosmic Rays (GCRs) permeate the galaxy and consist of protons, helium, and high-charge-and-energy ions. Solar Particle Events (SPEs) are dominated by hydrogen and helium ions with energies of several hundred millions of electron volts (MeVs). Albedo neutrons are produced in planetary atmospheres and surfaces and can be a significant source of human exposure. The albedo neutron decay produces electrons and protons that can have long lifetimes when decay is within planetary magnetic trapping regions, giving rise to intense trapped radiation belts.

Ionization leads to direct and indirect injury to the cell genome, resulting in cell death or latent damage that can lead to cancer and other effects. The energy per unit mass, locally deposited by radiation, is quantified as dose. When weighted for the estimated effectiveness of a particular type of radiation, the reference quantity is the equivalent dose. It is essential to recognize that risks are not measured or monitored directly. Instead, radiation quantities are used to estimate the associated risk.

NASA has established limits on the risk that may be incurred by exposure to space radiation. These limits are specified for missions in LEO. The limiting risk for career exposure to space radiation is an increase of 3 percent in the probability of developing a fatal cancer. Thirty-day and annual limits are based on keeping radiation exposure below the threshold level for deterministic effects. Also, NASA has incorporated the requirement to keep exposures "As Low as Reasonably Achievable" (ALARA) in the designs used and the operations conducted in space.

Unlike LEO exposures, which are often dominated by solar protons and trapped radiation, interplanetary exposures may be dominated by GCRs, for which there is insufficient data on biological effects. Consequently, risk prediction for interplanetary space is subject to very large uncertainties, which impact all aspects of mission design. This is especially true since ALARA requirement requires the use of appropriate safety margins, which are directly related to the uncertainty in risk estimates.

The ESMD Space Radiation Program strategy is to develop the knowledge base to accurately project health risks from radiation exposure and to recommend protection requirements. The overall objectives as well as the mission-specific strategies are identified below. Detailed radiation research and protection program objectives for lunar and Mars missions are:

- Ground-based space radiobiology research to establish a knowledge base to set radiation limits, estimate crew risks, and support shielding requirement decisions;
- Ground-based physics research to develop a particle interaction knowledge base, shielding design tools, and materials research;
- Lunar and Mars radiation limit definition;
- Environmental definition;
- Radiation dosimetry and monitoring equipment development; and
- Biological countermeasure development and integration (as needed).

Mission-specific strategies include:

- Use robotic precursor orbital and surface missions to understand the lunar neutron environment, develop reliable area monitors, and establish a high-energy proton capability.
- CEV-to-ISS missions will follow the ISS/STS mission operations model. Strategies include establishing reliable area monitors; integrating the ALARA requirement into the design; recommending the use of carbon composites in vehicle structures, shielding, and components early in the design; and providing recommendations on design optimization.
- Short lunar stay strategies must include integrating the ALARA requirement into the vehicle design and operations; recommending the use of carbon composites in vehicle structures, shielding, and components early in the design; and providing recommendations on design optimization. Sortie times may also be restricted by worst-case SPE definition and EVA suit shielding properties. Local shielding is recommended to minimize risks, and mission planning must consider trade-offs (e.g., habitat shelter shielding versus surface abort).
- Long lunar stay missions will likely require increased shielding over a short stay and the development of strategies to reduce chronic risk and GCR impacts. The inclusion of previous exposures for crew selection also becomes more important (astronauts with prior lunar or ISS missions).

Radiation Limits

NASA relies on external guidance from the National Academy of Sciences (NAS) and the National Council on Radiation Protection and Measurements (NCRP) for establishing dose limits. Due to the lack of data and knowledge, the NAS and NCRP recommended that radiation limits for exploration missions could not be determined until new science data and knowledge was obtained. Lunar radiation limits are being developed by the NCRP and the Chief Health and Medical Officer (CHMO), and there is some expectation that short-term and career limits will change; however, LEO limits were used for this study. The LEO career limit is the probability of 3 percent additional risk of lifetime lethal cancer within a 95 percent confidence interval. The LEO Blood-Forming Organs (BFO) short-term limits are: a 30-day limit of 25 Centigray Equivalent (cGy-Eq) and an annual limit of 50 cGy-Eq. For lunar missions, it is expected that NASA will implement dose limits based on the Risk of Exposure-Induced Death (REID) to replace limits based on Excess Lifetime Risk (ELR) of cancer. Also, information on fatal non-cancer risks, most notably heart disease, is under review. Research on radiation quality and dose-rate effects for heart disease risk is in an early stage; however, for protons of reasonably high dose-rates (>5 cGy/hr), a risk estimate can be made and suggests an increased fatal risk of 50 percent over the risk from fatal cancer alone. Risk projections will be augmented with projection of average life loss for exposure-induced deaths, with approximately 15 years projected for astronauts between the ages of 35–45 for SPE risks.

The ESAS radiation study addressed the relationship between shielding mass, dosage, and crew risk for the CEV. The probability of an event was determined using the two largest events on record for which accurate spectral information is available. The August 1972 event is generally accepted as the benchmark SPE in observable history. The confidence of not exceeding the August 1972 event fluence level above 30 MeV on a 1-year mission near the solar maximum is roughly 97 percent. (Note: High annual fluence levels are usually dominated by the largest event within the year.) To achieve a 99.5 percent confidence level above 30 Million Electron Volts (MeV), one must assume a fluence level about four times the August 1972 event. The probability of an event that would exceed the current LEO limits within any 1-week mission was estimated at 0.2 percent. The estimated probability of an SPE that could cause debilitation (1.5 times the August 1972 event) was estimated at roughly 0.03 percent. A debilitating event was identified as a dose that would cause vomiting within 2 days in 50 percent of the total population. The estimated probability of a catastrophic event (4 times the August 1972 event) causing death within 30 days was estimated at roughly 0.01 percent. These estimates were developed using historical data with no statistical analysis of the frequency distribution of the event.

The Analysis Cycle 2 radiation evaluation involved the analysis of a preliminary computer-aided design (CAD) model of the CEV. The CAD analysis results (shielding files) were used to conduct the final crew risk projections.

Mass sensitivity curves illustrating the reduction in radiation exposure to crew members within the CEV with increasing shield augmentation were calculated for two design case SPEs. Four times the proton fluence (no time dependence) of the August 1972 (King spectrum) event was evaluated, as well as four times the proton fluence of the September 1989 event. It was assumed that only one large design-basis SPE occurred during the specified mission length.

CEV Dose Data and Mass Sensitivity Curve

Since the Cycle 2 design exercise limited the mission length to 7 days, the largest concern for radiation exposure would be from SPEs. Mass sensitivity curves illustrating the reduction in radiation exposure to crew members within a CEV with increasing shield augmentation were calculated for the two SPEs. The internal systems represented in this CEV model were of fairly high fidelity. However, the outer hull of the vehicle was of fairly low fidelity, represented by an aluminum pressure shell and HDPE radiation shield. The areas between the chosen evaluation points and the outside environment that had the lowest radiation shielding consisted only of this aluminum shell and HDPE radiation shield. In general, thin (or lower radiation shielded) areas dominate the resultant radiation exposure to the crew inside the vehicle. These thinly shielded areas and the modeling of the hull and shield likely dominated the exposure estimates for this cycle of analysis.

The analysis was performed by first generating shield distribution files for the vehicle. The generation of these shield files is done by ray-tracing the CAD model. The ray-tracing output describes the amount and thicknesses of material between a chosen point and the outside environment. Two evaluation points were chosen to be consistent with the location of the crew member's torso in the seated position. Best estimates of material composition and density were assigned to the model elements for this evaluation. In addition, a volume representative of an SM was positioned relative to the CEV to approximate the shadow shielding effect that the SM would provide.

A radiation dose calculation was then performed for the skin, eye, and BFO using the equivalent spheres approximation. This approximation assumes a tissue depth of 0.01, 0.3, and 5 cm for the skin, eye, and BFO dose calculations, respectively. It should be noted that use of the equivalent spheres approximation can result in a two-fold overestimation of dose as compared to the more accurate computer-aided manufacturing (CAM) model that will be used in later analysis cycles. Doses were calculated for four times the August 1972 SPE, as well as four times the October 1989 event. These skin, eye, and BFO dose calculations were made for the vehicle with no parasitic shielding as well as with the addition of 5 grams/cm² of HDPE. **Table 4-5** shows a comparison to the Apollo Command Module, which corresponds to a thickness of approximately 5 g/cm², and a dose calculated using the CAM model.

Table 4-5. Analysis Cycle 2 Radiation Dose Calculations for Aluminum CEV with HDPE Supplemental Shielding

Organ Dose 4× 1972 SPE	Apollo	Aluminum CEV*		CEV + Poly 5 g/cm ²	
Skin (Gy-Eq)	10.36	42.63	47.75	12.25	13.72
Eye (Gy-Eq)	8.20	32.54	36.44	9.71	10.87
BFO (Gy-Eq)	1.39	4.17	4.67	1.56	1.73
Organ Dose 4× 1989 SPE		Aluminum CEV*		CEV + Poly 5 g/cm ²	
Skin (Gy-Eq)		23.40	25.98	7.10	7.88
Eye (Gy-Eq)		16.57	18.39	5.42	6.01
BFO (Gy-Eq)		2.73	3.03	1.29	1.40

*Note: Two columns for CEV represent two locations within vehicle.

Figure 4-9 is also represented by a mass sensitivity curve for the BFO dose versus the mass of the HDPE shield. This was made for four times the August 1972 and October 1989 events. The thickness of the radiation shield was varied from 0 to 5 g/cm² and plotted according to the corresponding shield mass. The shield at 5 g/cm² was effectively at the maximum mass (1,360 kg) allotted for the supplemental radiation shield.

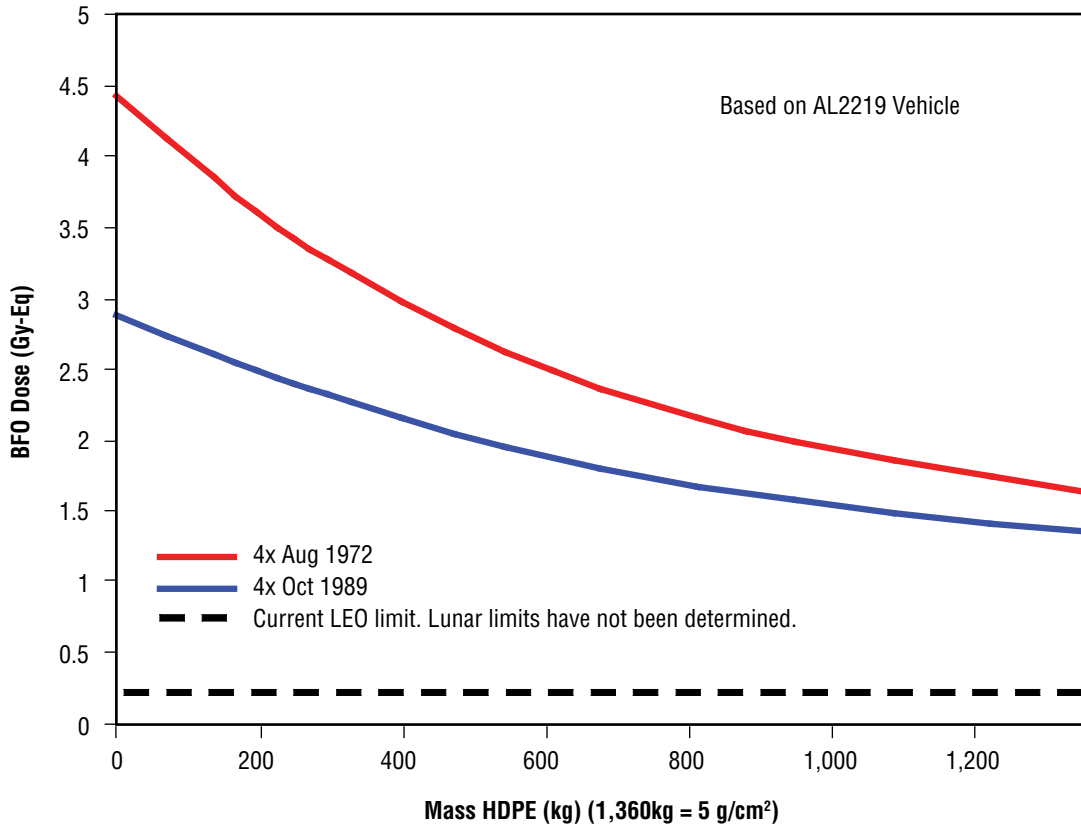

Figure 4-9. Mass of HDPE

CEV Radiation Risks and Shielding

Using the shielding files provided by the above-mentioned analysis, probabilistic estimates of risk and loss-of-life were calculated for a 35- and 45-year-old female as well as a 35- and 45-year-old male. A three-layer version of aluminum or graphite/epoxy, polyethylene, and tissue was employed. No previous occupational radiation exposure was assumed for any of these representative crew members. The current radiation limit is a 3 percent fatal cancer probability within a 95 percent confidence interval. The calculation considers age/gender, radiation quality, SPE dose-rate, shielding materials, and prior ISS/CEV missions. As indicated by **Table 4-6**, all representative crew members exceed the 3 percent probability of fatal cancer risk for the CEV without any supplemental shielding. When 5 g/cm² polyethylene is added to the CEV, the risk drops below 3 percent; however, the upper 95 percent confidence interval exceeds the LEO limit.

Table 4-6. Excess Lifetime Cancer Risk for Shielded and Unshielded CEV as a Function of Crew Member Age and Gender

4× 1972 – Equivalent Solar Proton Event – CEV				
Organ Dose	Aluminum CEV		Vehicle + Poly 5 g/cm ²	
Crew Characteristic	%Risk	95% C.I.	%Risk	95% C.I.
Male 35-yr	9.7	[3.4, 17.5]	1.7	[0.5, 4.7]
Male 45-yr	7.5	[2.7, 16.4]	1.3	[0.4, 3.5]
Female 35-yr	12.1	[4.0, 17.6]	2.1	[0.7, 5.9]
Female 45-yr	9.1	[3.2, 17.3]	1.5	[0.5, 4.3]
4× 1989 – Equivalent Solar Proton Event – CEV				
Organ Dose	Aluminum CEV		Vehicle + Poly 5 g/cm ²	
Crew Characteristic	%Risk	95% C.I.	%Risk	95% C.I.
Male 35-yr	6.9	[2.4, 15.8]	2.2	[0.73, 6.0]
Male 45-yr	5.3	[1.9, 13.4]	1.7	[0.57, 4.5]
Female 35-yr	8.6	[2.9, 17.1]	2.8	[0.9, 7.6]
Female 45-yr	6.4	[2.3, 15.3]	2.0	[0.7, 5.6]

C.I. = Confidence Interval

CEV Acute and Late Risks

SPEs represent the greatest concern for radiation exposure during the short-duration lunar missions. For estimating acute risks, calculations using the Nuclear Regulatory Commission (NUREG) fatal accident risk model were performed. The NUREG model is unable to properly evaluate acute risks (mortality or debilitating sickness) below a 10 percent probability because of the uncertainties in sigmoid dose-response curves characteristic of deterministic effects near thresholds. Also, microgravity research suggests that altered immune and stress responses could skew the lower probabilities of dose responses to reduced dose levels complicating the evaluation of acute risk near the threshold (less than 10 percent risk). Depending on the baseline CEV design, acute risks are possible for an event with the 1972 spectral characteristics and two to four times the F(>30 MeV) fluence. Future research and analysis will be needed to establish the correct dose response under these conditions. For a baseline CEV shielded with targeted >2 g/cm² of polyethylene shielding, acute effects are unlikely from such events, as shown in **Table 4-7**.

Table 4-7. CEV Acute and Late Risks for Various Depths of HDPE Radiation Shielding

Aluminum Vehicle, 4× 1972 SPE			
HDPE Depth (g/cm ²)	% Acute Death*	% Sickness	% REID**
CEV-old + 0 g/cm ²	9.5	54	9.1 [3.2, 17.3]
CEV-new + 0 g/cm ²	<1% (***)	<5% (***)	4.4 [1.5, 11.8]
CEV-new + 1 g/cm ²	0	0	3.5 [1.2, 9.7]
CEV-new + 2 g/cm ²	0	0	2.9 [1.0, 8.2]

*Death at 60 days with minimal medical treatment

**Risk of Cancer death for 45-yr-old females

***Too close to threshold to estimate

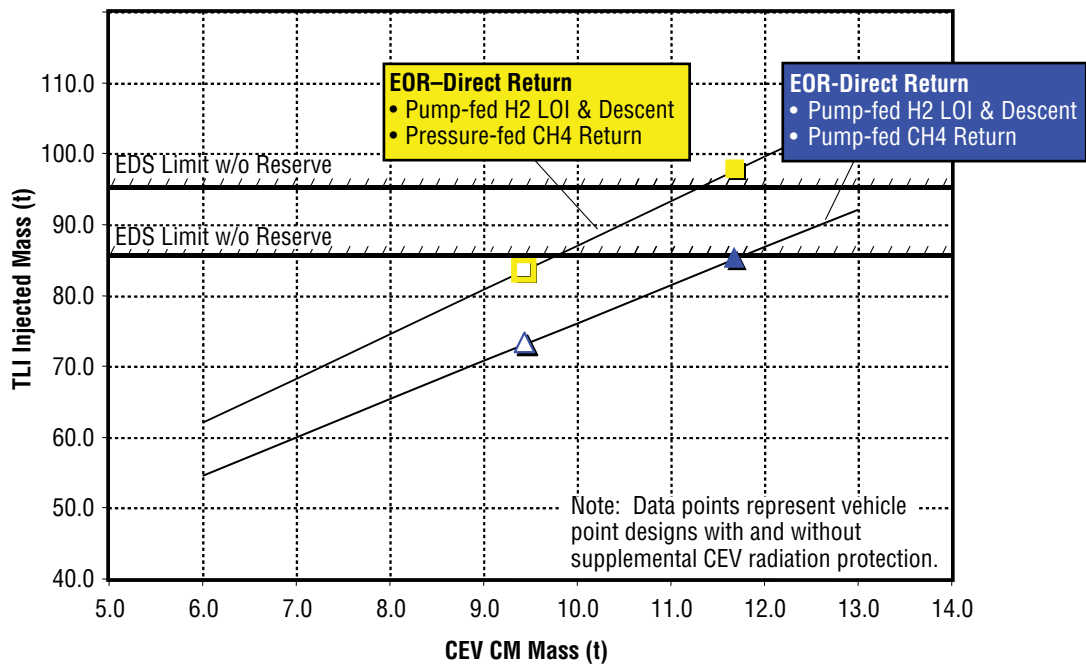

Figure 4-10. TLI Injected Mass versus Crew Compartment Mass, With and Without 5.0 g/cm² Supplemental Radiation Protection

Cycle 2 Radiation Analysis Impact on CEV and Mission Design

The ESAS team reviewed the radiation analysis with an eye toward reducing the supplemental radiation shielding that was resulting in a diminishing benefit to the crew. **Figure 4-10** illustrates the effect of supplemental radiation shielding on injected spacecraft mass. Since the radiation shielding mass is carried round-trip, its mass has one of the greatest mass sensitivity penalties, which identifies it as a candidate for additional analysis. (Refer to **Table 4-4** for more information.) ESAS engineers and safety and risk analysts agreed to proceed into a third analysis cycle utilizing a maximum of 2.0 g/cm² of supplemental radiation shielding—the range in which the dose analysis indicated that shielding had the greatest effect. The dose and biological risk data was derived from a 4-times-1972 event that represented a 99.5 percent confidence of not exceeding a fluence level exceeding 30 MeV for a mission duration of 1 year. Therefore, for a 16-day maximum mission (0.04 year duration), the probability for exceeding a 0.01 percent probability of acute death, a 1.9 percent probability of debilitating sickness, and a 3.4 percent probability of excess cancer risk is itself only 0.005. For 5 g/cm² of shielding, these values are either zero or approaching zero.

The data presented above led the ESAS team to take a number of actions. First, based on the team’s recommendation, the CEV CM would incorporate the use of composite materials, in addition to an aluminum pressure shell, as part of the cross-sectional skin of the vehicle. Secondly, the ESAS team recommended additional analysis to more accurately model the CEV cross-section and to further investigate the range of supplemental radiation shielding from 0 to 2.0 g/cm². These decisions would form the basis of the Cycle 3 radiation analysis presented in **Section 4.2.5, Analysis Cycle 3 Mission Mode Analysis**.

4.2.4.1.2 LOX/CH₄ versus Storable Propellant Trades

Many NASA studies have evaluated propellant combinations of on-orbit propulsion for spacecraft. These include various combinations of Oxygen (O₂), Hydrogen Peroxide (H₂O₂), Nitrous Oxide (N₂O), Nitrogen Tetroxide (NTO), and Chlorine Pentafluoride (ClF₅), together with fuels such as Hydrazine (N₂H₄), Monomethyl Hydrazine (MMH), Hydrogen, Ethanol (EtOH), Methane (CH₄), Propane (C₂H₆), and Kerosene (RP1). The propellants exhibiting the best overall characteristics from these studies are LO₂/LH₂, LO₂/LCH₄, LO₂/EtOH, and MMH/NTO. This section will focus on two of these options as the primary alternatives for the CEV SM service propulsion system as well as the ascent propulsion system for the LSAM—LOX/CH₄ and MMH/NTO. Storable MMH/NTO systems are well understood and have an extensive operational history; however, LOX/CH₄ is of particular interest because it is high-performing, non-toxic, and can be obtained from Martian and lunar in-situ resources (CH₄ from the Martian atmosphere and LOX from the Martian and lunar soil).

Performance Comparisons

MMH/NTO propulsion systems are well-characterized, with substantial flight history. These propulsion systems provide the light dry mass systems and good packaging compared to most other propellant combinations. NTO and MMH ignite hypergolically, thus eliminating the need for igniters and reducing system complexity. However, due to the mechanism of hypergolic ignition, the formation of Fuel-Oxidizer Reaction Products (FORPs) can occur for short pulses in a cold vacuum environment, as has been noted on the Shuttle 870-lbf (vacuum) primary thrusters and Apollo-110 lbf (vacuum) attitude control thrusters. In addition, iron nitrates can form in the NTO, which could result in flow decay or valve stiction. Iron nitrate formation is most common in NTO systems when moisture is introduced into the propellant. Nitric acid then attacks iron alloy lines and components, leeching iron from those lines and components to form iron nitrates, which can then be deposited in tight-tolerance flow passages due to pressure and temperature drops as the oxidizer flows through those passages. The deposition of iron nitrate in tight flow passages further reduces the propellant flow through flow passages and can cause stiction in sliding components (i.e., valves). Flow decay can affect engines by causing off-mixture-ratio combustion which, in a worst-case scenario, could result in non-ignition events. Iron nitrate formation is most common in multiuse spacecraft (such as the Shuttle Orbiter) and long-duration spacecraft that contain a significant amount of stainless steel lines and/or components. NTO will freeze at approximately 12°F and is, therefore, not considered to be truly space-storable, since significant heater power is required for in-space operations. NTO and MMH are usually stored and used at temperatures greater than 65°F, and, as a result, significant heater power is required to maintain the bulk propellant temperature and maintain lines and components (especially thrusters) within acceptable temperature bands. NTO and MMH are not synergistic with common fluid systems (e.g., common fluids for propulsion, fuel cell reactants, breathing air, and water production) and In-Situ Produced Propellants (ISPPs) and, therefore, do not benefit from the mass and complexity savings that potentially could be realized through the use of common-fluid spacecraft. NTO and MMH are also highly toxic, thus impacting ground and in-space crew operations. Toxic propellants mostly affect reusable spacecraft, but will also affect single-use spacecraft since the servicing and maintenance of toxic propellant systems require expensive personal protective procedures and gear to be used for those operations. Despite the known negatives, the 40-plus year experience with NTO/MMH propulsion systems establishes NTO/MMH to be the lowest risk option for the successful development of the propulsion system of the CEV SM and LSAM.

Liquid oxygen/methane (LOX/CH₄) has no flight history and very limited ground-test history. For the high-risk areas of engines, propellant storage and distribution, and components, the characteristics of LOX/LCH₄ must be extrapolated from the limited ground test. However, this limited ground test has shown the combustion performance to be suitable for use as a propellant. LOX/LCH₄ is a clean-burning propellant combination. LOX does have an extensive history as a fluid on spacecraft and as propellant on propulsion stages; however, the on-orbit operational experience for LOX systems is limited. The safe handling and safe system design aspect of LOX are well understood. LOX/CH₄ does offer higher Isp performance compared to state-of-the-art storables (i.e., NTO/MMH), without the volume increase that is common with LOX/LH₂ systems, which results in an overall lower vehicle mass as compared to MMH/NTO propulsion systems. A LOX/LCH₄ system uses less power, on the order of 1,000 watts less power, than comparable MMH/NTO propulsion systems, thereby significantly reducing the mass of the spacecraft power system(s). The primary advanced development risk areas that must be addressed for LOX/CH₄ propulsion systems are the ignition system, long-duration cryogenic storage, propellant acquisition, and propellant quality management within the distributed propellant feed system. The feasibility of storing LOX for 180 days has been demonstrated in ground tests using a 15,000-lbm capacity flight-weight tank (with all penetrations). These tests achieved 1.3 watts total heat leak for the tank. Basic ignition of O₂ and methane has been proven to be feasible; however, the reliable ignition of LOX and methane over the range of propellant conditions and mixture ratios must still be established. During advanced development, the demonstration of robust hardware for spacecraft use is required in order to support vehicle subsystem development. Additional risk mitigation for development will be conducted to allow margin in boil-off and lower Isp for ISS missions, since these missions require less delta-V. LOX/CH₄ propulsion systems offer significant gains in spacecraft performance, and the risks of developing a LOX/CH₄ system appear to be manageable. However, the tight development schedule for the CEV puts the successful development of a LOX/CH₄ system for the SM at risk.

An independent assessment of the ESAS Envision weight and sizing model for the CEV SM, using a more detailed model of the propulsion system, was performed to evaluate the different propellant and configuration options and validate the Envision results. The model considered the mass of the structure, propellant tanks, engine, feed system, boil-off, and power system impacts. The Isp of the engines was generated with a common set of engine parameters (area ratio, chamber pressure, thrust, etc.) and by applying a common efficiency of 94 percent of ideal. Power system sizing information from NASA Glenn Research Center (GRC) was provided to allow the impacts of propulsion system power needs to be evaluated. The results (**Figure 4-11**) showed that LOX/methane provided overall higher performance than MMH/NTO and LOX/LH₂ for pressure-fed configuration. The pump-fed options that were evaluated examined integrated service propulsion system and Reaction Control System (RCS) propulsion, as well as separate RCS. If the RCS is separated, additional reserves are required for RCS, as well as redundancy in the service propulsion system, since RCS can no longer perform backup.

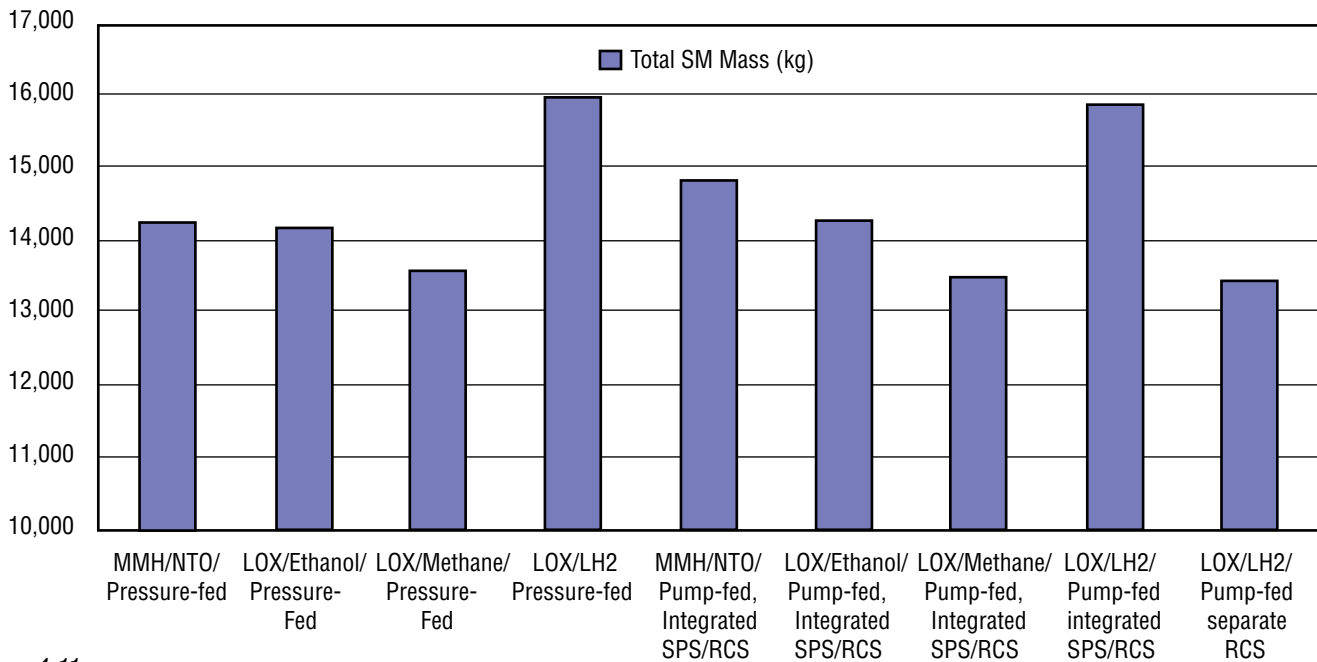

Figure 4-11.
Total SM Mass

The results show that pressure-fed and pump-fed LOX/LCH₄ are the lightest mass systems. Pump-fed LOX/LH₂ does not perform as well, despite its much higher Isp, due to the increase in structural mass (due to the SM being twice as big), the boil-off for 6 months, the addition of the service propulsion system for redundancy, and a separate RCS. LOX/LH₂ is better suited to systems that require more delta-V than an SM. The higher dry mass, volume, and complexity of LOX/LH₂ pump-fed systems are the main drivers in selecting an LOX/LCH₄ pressure-fed system. The LOX/LH₂ stages have the heaviest dry mass, especially the pressure-fed LH₂ systems due to the LH₂ tank mass at high pressures. The total volume of the propulsion is much larger for LOX/LH₂ (by 2.5 times) compared to LOX/LCH₄. This has a direct effect on the SM structure. An assessment of the total number of propulsion system components shows comparable totals for all systems except for the LOX/LH₂ main system with a separate RCS. For MMH/NTO, the heater components were ignored. This would make it comparable to the other pressure-fed systems. These independent results compare well to the Envision results—within 2 percent.

Reliability Comparisons

The Apollo experience with hypergolic propellants was examined by the ESAS team. The failures indicated similar experiences to Shuttle relative to FORP, although not at the same failure rates. The Shuttle experienced more iron nitrate problems within the NTO system (manifesting itself as flow decay and stiction), although it should be noted that the R4D thruster used during Apollo may have had one oxidizer valve problem. The failures experienced in the Apollo program included four FORP-related engine failures and one oxidizer valve contamination failure.

For LOX/LCH4, the only experience is with ground testing, so its predicted reliability is based on a very limited data set. Key risk areas that have been identified are reliable LOX/LCH4 igniters and thermally efficient RCS propellant feed systems.

Table 4-8 shows the probability of failure modes for the Shuttle Orbital Maneuvering System (OMS). The failure rate is driven by blockages in the feed system, which is usually the result of foreign object debris in the system. For both MMH/NTO and LOX/LCH4, it is assumed that a verification test of the feed line integrity and design pressure drop test capability will be used to screen out blockage failures. **Table 4-8** compares the reliability aspects of these propellant combinations by adjusting the values using qualitative rationale and experienced engineering judgment.

	OMS System		MMH/NTO		LOX/Ethanol/Methane	
	Probability	Contribution	% Adjustment	New Value	% Adjustment	New Value
Failure to Start (igniter vs. hyper problems)	6.38E-07	0%	100%		100%	
Bi-Prop valve	1.10E-05	2%	100%		100%	
Blockage	5.24E-04	84%	10%		10%	
Burnthru	7.86E-07	0%	100%		100%	
Fuel Block	1.06E-05	2%	100%		100%	
Helium	3.43E-05	5%	100%		100%	
Nitrogen	1.01E-05	2%	100%		100%	
OX Block	1.06E-05	2%	100%		100%	
PAD/LAD/PMD	2.32E-05	4%	100%		100%	
Iso Valves	1.32E-06	0%	100%		100%	

Table 4-8. Probability of Failure Based on Shuttle Model and Adjusted for CEV MMH/NTO and LO2/LCH4

The reliability assessment for pump-fed versus pressure-fed was assessed by using pump-fed engine reliability estimates and then deleting components (e.g., engine valves and a thrust chamber assembly) not required for a pressure-fed engine, as shown in **Table 4-9**. The result is that pressure-fed engines are five times more reliable than pump-fed engines.

Table 4-9. Pump-Fed versus Pressure-Fed Engine Reliability

Component	SSME Block 2	RL-10A-4-2	Pressure-fed
Actuators	1.07E-06	10.00%	10.00%
Anti-flood valve	3.58E-09	100.00%	0.00%
Fuel preburner	8.84E-07	0.00%	0.00%
Fuel/Hot gas system	1.20E-05	0.00%	0.00%
Heat exchanger	2.07E-06	0.00%	0.00%
HPFTP/AT	6.99E-05	50.00%	0.00%
HPOTP/AT	4.10E-05	50.00%	0.00%
Igniters	3.58E-09	100.00%	100.00%
LPFTP	1.19E-06	0.00%	0.00%
LPOTP	4.62E-06	0.00%	0.00%
LTMCC	4.69E-05	22.00%	0.00%
Main injector	1.13E-05	22.00%	0.00%
Nozzle	2.82E-05	50.00%	50.00%
Oxidizer preburner	2.44E-06	50.00%	0.00%
Oxidizer system	5.07E-06	100.00%	0.00%
Pneumatic system	7.83E-06	100.00%	100.00%
Powerhead	1.04E-06	100.00%	0.00%
Valves	8.46E-07	100.00%	100.00%
Other risk	4.58E-05	100.00%	10.00%
Failure Rate for 500 sec burn duration	2.82E-04	1.44E-04	2.75E-05

Pressure-fed 5.25 times more reliable than pump-fed

A more detailed reliability and risk assessment for the various in-space propulsion system options that includes an assessment of propellant type, engine-out, pump-fed versus pressure-fed, heritage, and reliability growth is contained in **Section 8, Risk and Reliability**.

Restart of Engines After Long Dormant Periods

The restart of engines after long periods of dormancy is driven by the process used to shut-down the engine, the protection provided during mission, and the process used to prepare the engine for restart. The primary issues associated with LOX/LCH₄ are how to vent the lines and cavities and potential freezing of propellants. On startup, the cold temperatures in the igniter (less than -120° F) may require heaters. The primary issues with hypergolic propellants are how to shutdown the system for dormancy and safe the lines and engines if wetted. Heaters are required for wetted portions of the system to prevent freezing. Other potential issues are seat swell and flow decay of iron nitrates.

On startup of pressure-fed systems, the lines must be primed with propellants at start box conditions. For hypergolics, it may be required to preheat the propellants with heaters to start conditions. For pump-fed engine startup, the lines are primed with propellants at the start box conditions. For hypergolic engines, there are additional parts (Gas Generator (GG), chamber) for the engine to warm up for ignition. For cryogenic engines such as the RL-10, additional steps to chill-down the pump, condition the igniter temperature, and ensure the proper chamber regeneration circuit temperature for boot strap startup is required.

Engine Throttleability for Descent Stages

For all throttling engines, it is critical to maintain the injector pressure drops necessary for proper propellant injection and mixing over the throttling range. There are at least two approaches for deep-throttling pressure-fed engines: (1) a sliding pintle to control injection orifice size and (2) dual-circuit injectors. Both approaches have been tested and demonstrated, although additional research is required. In general, engine throttleability does not appear to be a major discriminator between the engine options.

LOX/LCH4 Cryogenic Propellant Management

A review of LOX/LCH4 development history and literature was performed to address cryogenic storage, acquisition, and distribution. In addition, a detailed analysis of the CEV LOX/LCH4 propellant tanks that addressed the environment and the CEV configuration (e.g., radiators) was performed.

Cryogenic propellant handling and storage has been demonstrated for space applications since the 1960s. Some of the more applicable tests have demonstrated flight-weight tanks of 15,000 lbm capacity and heat leaks of 1.3 watts with very low boil-off rates. The recent tank design for Shuttle upgrades for a 10,500 lbm-capacity tank looked at the pressured vessel and Liquid Acquisition Device (LAD) design. Propellant tanks and LADs are critical long-lead items and require significant development and testing in low-g and thermal vacuum tests. The options and issues associated with long-term storage of various cryogenic fluids on the lunar surface were examined. Thermal models of LOX, LCH4, and LH2 tanks were built for the SM. The model shown in **Figure 4-12** predicted 3.3 watts total heat leak. The equivalent boil-off rate for 3.3 watts is 0.15 lbm/hr. The use of H2 in place of CH4 is projected to boil-off at 5 percent per month with this configuration.

- Tanks are surrounded by
 - ECLSS Radiators
 - CEV
 - Engine Plate
- Applied fixed temperatures to
 - ECLSS 300K
 - CEV 300K
- Applied heat load to
 - Engine Plate 200 W/m²
 - Ring 80 W/m²
- Tank MLI Temperatures
 - 263K with heat load
 - 253K without heat load
- Sun was not applied

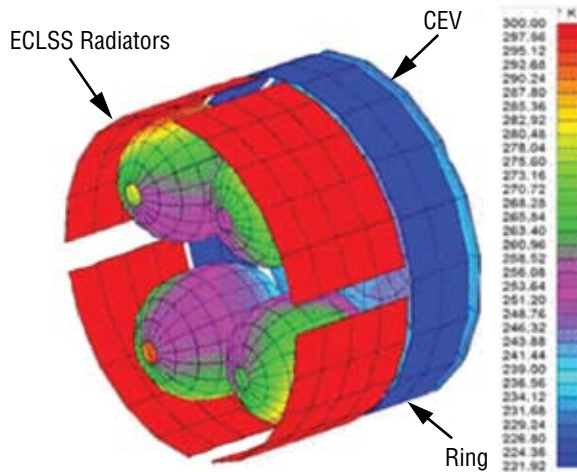

	Engine Shield 253K	Engine Shield 263K	Reference
Insulation heat	1.4	1.6	Scaled from 1997 H2 testing
Strut heat	.93	.93	Utilizing tension straps, existing design
Feed line heat	.6	.6	Modeled
Helium tank	.3	.37	60 layers MLI, coupled to LOX tank
Penetration heat	.1	.1	Small tube and wire harness heat
Total heat (all heat units are watts)	3.3	3.6	

Figure 4-12. Analysis of SM Cryogenic Tank Heat Leak

The cryogenic RCS feed system also requires thermal management. The principle of operation is to use a highly subcooled propellant, such that it can be allowed to warm up by 40°R by the time it gets to the engines, yet still remain a subcooled liquid in the lines. The thruster usage during active periods is approximately 2 lbm/hr, which can absorb approximately than 9.3 watts (32 Btu/hr) into the feedlines and still remain subcooled by 30°R. Therefore, the total heat leak into the feed system from the lines must be less than 9.3 watts (32 Btu/hr). This is achievable, assuming 75 ft for the three manifold feedlines at 0.2 Btu/hr/ft and 0.5 Btu/hr for each of the 16 thrusters and 12 feed system valves. (Note that 9.3 watts is three times the heat leak into the tank. This is felt to be conservative.) Achieving these heat leak rates will be the focus of advanced development tasks. The risk mitigation is for early flights to carry enough margin to vent propellants to condition the feedlines.

Figure 4-13 shows the three redundant RCS manifolds, each with a thermodynamic vent at the end of each manifold that is used to intercept and reject any heat leak. During quiescent periods, there is not enough thruster usage to absorb and reject the heat. There are two possible operational solutions: either (1) vent some propellant at 0.5 lbm/hr thermodynamically to chill the lines or (2) allow the propellant in the lines to turn to gas. This Thermal Vacuum Stability (TVS) gas could be used propulsively for a minimum impulse to control attitude. These modes should be explored in vehicle design trades.

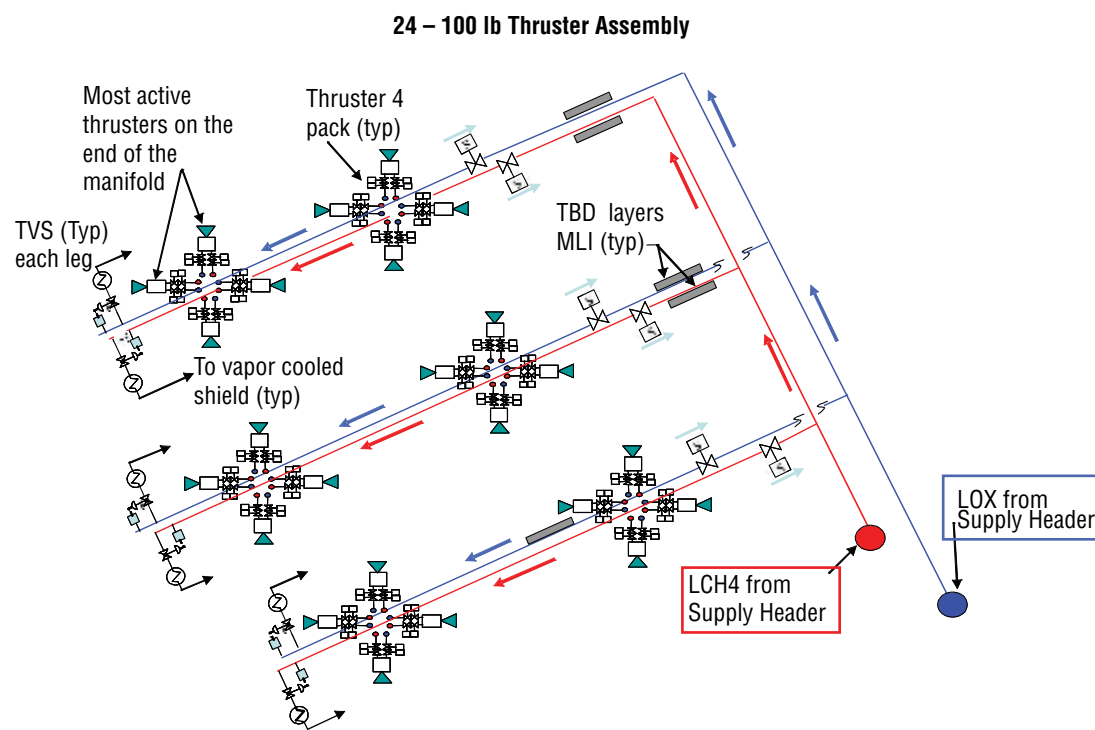

Figure 4-13. RCS Manifolds

Common LADs for use in zero-g use surface tension properties of the fluids to preferentially wet surfaces or screens that lead to the tank outflow port through channels. Fluid acquisition performance is limited by a maximum pressure at which surface tension forces can exclude gas from flowing through the device. This pressure is known as “bubble point,” since it is the point where gas bubbles begin to appear on the liquid side of the screen. “Bubble point” is a function of liquid surface tension and pore size. Very fine pore sizes can be obtained with the use of fine-mesh wire screens. Unfortunately, because the pores of the fine-mesh screen are irregular in shape, an analytical calculation of the “bubble point” is not possible. Thus, the fine-mesh screens for LADs require empirical characterization with the liquid of interest. Most of the testing with cryogenic propellants in the literature has been with LH2, since this is the propellant with the lowest surface tension. LOX testing is currently in progress at NASA GRC, and CH4 testing could use the same GRC hardware.

In reviewing CEV operations, it was concluded that the LOX/CH4 RCS will require low-g acquisition systems, while the LOX/CH4 propulsion system could use settling thrusters. However, integration of the RCS and the propulsion system could provide start capability without settling burns. Based on this assessment, a liquid acquisition strategy was proposed, using a compartmented tank similar to the current Shuttle OMS tanks shown in **Figure 4-14**. The upper compartment contains propellant for main burns with acquisition via settling. The upper compartment is unscreened except for a communications window to the lower compartment. The lower compartment contains a series of channels with one side covered in a fine-mesh screen. The channels are located so that some portion of the fine-mesh screen is always in contact with liquid propellant, regardless of gravity environment. The lower compartment contains propellant for the RCS as well as enough propellant to run the main engine from start until propellant settling is achieved.

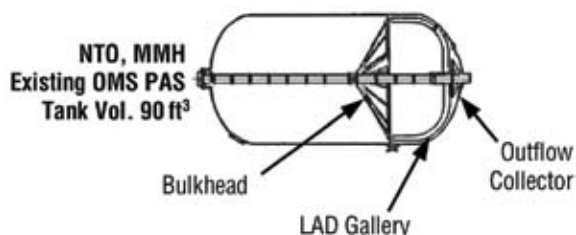

Figure 4-14. OMS Tank Internals Showing LAD Approach

State-of-the-art storable LADs are routinely flown without a low-g flight test for commercial applications. The Shuttle uses screen channel LADs in both RCS and OMS tanks. Shuttle LADs are qualified by a subassembly ground test, a KC-135 test, computer modeling, and flight demonstration during the first four Shuttle missions. Although the Shuttle LADs have operated reliably throughout the Shuttle program, a review of the history revealed several issues with this approach. Technology Readiness Level (TRL) 6 was not achieved until the end of the first four Shuttle mission flights. On-orbit flight operation revealed start transient pressure drops not anticipated by the ground program. The problem was controlled by reducing the number of RCS engines allowed to fire simultaneously. Another issue was that screens required extensive handwork repair to maintain “bubble point” throughout. The Shuttle LADs qualification program also required 7 years to complete.

The approach to qualifying cryogenic LADs for the CEV is based on the approach used to qualify the Shuttle OMS and RCS storable LADs. The same strategy is used for both LOX and methane. Key areas or issues to address are fluid properties for the design region and screen “bubble point” data for the fluids and temperatures of interest (i.e., subcooled LOX viscosities). First, the characterization of fine-mesh screens with LOX would be performed. Secondly, existing equipment would be used for CH₄ screen characterizations. Once the characterizations are complete, a new rig for ground testing full-size screen channels will be built. It will be necessary to contract with aerospace manufacturers for LAD build-and-assembly, since capabilities for working with fine-mesh screen and assembly of complex LAD assemblies are limited within NASA. A low-g flight will be required to fully qualify the design. This could be the first flight of the full-up system if the program is willing to take the risk. Risk mitigating factors are that (1) the fluid properties of LOX/CH₄ are very similar to storable propellants and (2) a TRL 5 design with design margins was successfully used on the Shuttle program. If the first flight approach is undertaken, it will be critical to build design margins into the tank LAD and then gradually expand the operating envelope.

LOX/LCH₄ Engine Ignition and Combustion

The physical properties of LOX/LCH₄ combustion were examined to attempt to identify any issues. The ignitability of methane in pure oxygen is suitable for the range used in rocket engine spark igniters. Methane is flammable from 0.66:1 to 20:1. The flame speed is good at 43 cm/sec (ethanol is 45 cm/sec). The minimum ignition energy is 0.28 mj for methane. (Ethanol is 0.15 mj.) (Note: RCS engine igniters use 10 to 90 mj sparks to improve ignition.)

A survey of the engine and component test history for LOX/LCH₄ was examined. Upper stage work has primarily been in the form of engine studies with some injector and igniter component testing. No major issues were found, but significant advanced development is required. One major finding is that future LCH₄ specifications should ensure that sulphur has been removed from the propellant.

NASA GRC has performed ignition and combustion tests on oxygen and methane. In the early 1980s, Liquid Natural Gas (LNG) test programs performed combustion performance and testing. A hydrocarbon ignition project, shown in **Figure 4-15**, was performed in 1987 and 1988, and a Combustion Wave Ignition (CWI) was performed in 1992. A laser-induced spark ignition test program with Gaseous Oxygen (GOX)/methane was also performed in 1994.

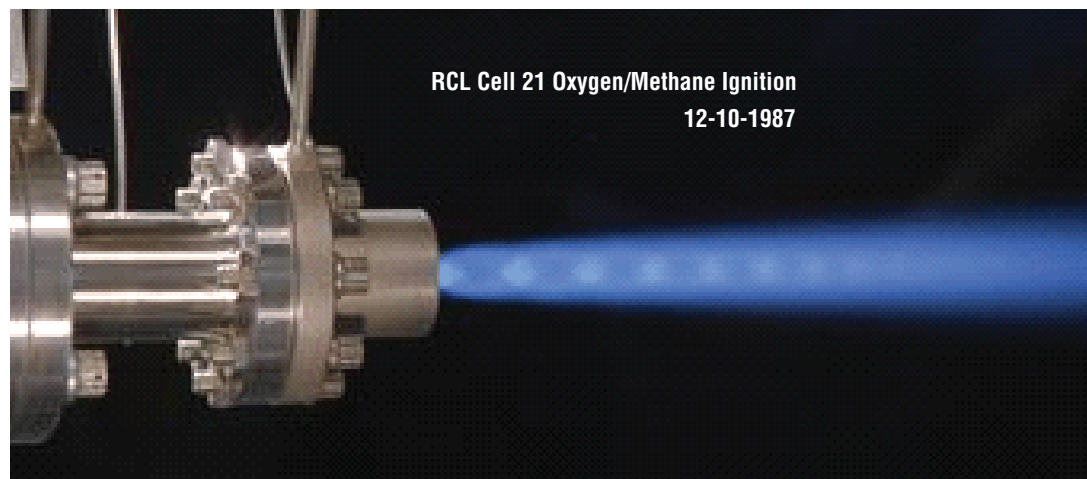

Figure 4-15.
Hydrocarbon Engine
Test Project

Rocketdyne has performed LOX/LCH₄ tests on various contracts primarily related to large engine chambers and gas generators. The High-Pressure LOX/CH₄ Injector Program, NASA Marshall Space Flight Center (MSFC) contract NAS8-33206 (1978-1979), examined coaxial and impinging elements for high-pressure LOX/CH₄ operation with an existing 40 klb-thrust chamber. The shear coaxial element injector was fabricated, flow-tested, and delivered to MSFC for hot-fire testing. In 1988, MSFC tested the 82-element injector over nine main stage tests at $P_c = 1207$ to 2381 psia, $\rho/F = 2.48$ to 3.49 , and C^* efficiency = 98.3 to 100.6% .

Rocketdyne, as part of the Methane Heat Transfer Investigation for NASA MSFC contract NAS8-34977 (1985), investigated the cooling and coking characteristics of LNG (92.5 percent methane) using an electrically heated bimetallic tube test apparatus. The project completed 37 tests over a range of heat fluxes $Q/A = 1.6$ to 85 Btu/in²-sec, coolant velocity = 181 to 781 ft/sec, and coolant pressure = $3,914$ to $4,966$ psig. This established the Nusselt number correlation of LNG-cooled channel wall combustors. Corrosion of the copper wall was attributed to trace amounts of sulfur in the LNG. The corrosion had an influence on heat transfer and pressure drop. No evidence of coking was seen, even at wall temperatures over 870° F.

Aerojet has experience with gaseous and liquid oxygen-based RCS, primarily with ethanol, but also with some methane tests. Aerojet has developed and delivered the hardware for a 500-lbf GOX/Gaseous Methane (GCH₄) system for the X-33 (**Figure 4-16**). Successful ignition was obtained, except under certain conditions. Aerojet has designed a 150-lbf GOX/ethanol thruster, designed and tested a 620-lbf GOX/ethanol thruster, and designed and tested an 870-lbf LOX/ethanol thruster. Several tests with LOX/methane injectors were performed in the 1980s. A LOX/LCH₄ 30-klbf @ $2,200$ psia injector was extensively tested at MSFC.

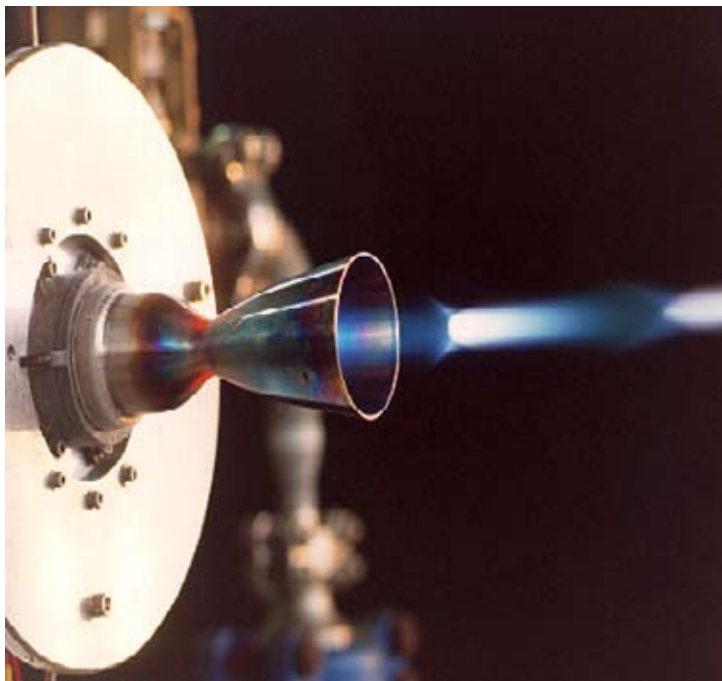

Figure 4-16. 500-lbf GOX/GCH₄ Thruster

Russian engineers have designed and extensively tested entire LOX/methane engines of various thrust levels, but none have been flown to date.

LOX/LCH4 Development Issues and Risks

It was determined that, in order to reduce risk for development, a LOX/LCH4 propulsion system must undergo advanced development to a prototype system level of flight-weight pressurization, tanks, feed system, and engines. These advanced development tasks must address cryogenic storage, liquid acquisition, a cryogenic liquid RCS feed system, and engine tests with an emphasis on ignition.

Key highest risk areas include the following:

- Igniter design for LOX/LCH4 ignition over a wide range;
- Flight-weight robust spark plug;
- Cryogenic RCS feed system; and
- Propellant management device.

Moderate risk areas include the following:

- Flight-weight excitor;
- Light-weight pressure vessel (composite overwrapped Aluminum-Lithium (AL-Li));
- Propellant isolation valve;
- Low-heat leak cryogenic tank;
- LOX/LCH4 injector and chamber; and
- Engine valves.

Based on these risks, schedules for a 10-klbs-thrust class, pressure-fed LOX/methane engine system that is throttleable 10:1 for a 2018 human lunar landing were developed. It was determined that a non-throttleable version for the ISS SM in 2011 is feasible, but requires significant advanced development.

4.2.4.1.3 Surface CEV Configuration Studies

One of the three mission modes under consideration, EOR-direct return, requires the CEV to descend to the lunar surface, where it serves as the crew's surface habitat for the duration of the lunar sortie surface mission. This mission mode is potentially attractive because it eliminates the development of a costly second crew cabin for the LSAM; however, it does require the CEV to perform a number of new and unique functions. In addition to serving as the crew cabin for Earth ascent, LEO rendezvous and docking, trans-lunar cruise, lunar orbit operations, trans-Earth cruise, and Earth entry, the EOR-direct return CEV must also be configurable for lunar ascent and descent powered flight and the EVA support and surface habitation functions of the surface mission.

The ESAS team also recognized that the EOR-direct return mission may have advantages in terms of risk and reliability because of the reduced number of operations and vehicles. To fully analyze this mission mode, the team had to compare its cost, performance, and risk characteristics to other mission modes. Like other mission modes, the technical performance of the EOR-direct return mission began with an analysis of the CEV volume required for this distinct mission type. The direct return CEV would require more habitable volume than the LOR-based CEVs because it must accommodate the same crew of four in lunar surface EVA suits in a gravity environment. In the following analysis, this volume was configured two different ways: first, as a single volume where all end-to-end mission functions were performed, and, secondly, as a "split volume" where the surface-specific airlock and EVA functions were split from the remainder of the CEV functions.

EOR-Direct Return Volume Overview

The required equipment volume for the single volume, EOR-direct return CEV is 15.9 m³, which is somewhat larger than required for the LOR-based LSAM due to the additional provisions for the total mission duration, not just for the lunar portion. The net habitable volume required of the single volume, EOR-direct return CEV is 21.4 m³, which is exactly the same as for the LOR LSAM, because EVA lunar suit stowage is required. Therefore, the total required pressurized volume is 37.3 m³. In addition to lunar EVA suit stowage, the other driver of net habitable volume is serial donning of lunar surface EVA suits, requiring 17.3 m³ of net habitable volume and 33.2 m³ of total pressurized volume. The larger equipment volume accounts for the larger total pressurized volume of the single volume, EOR-direct return CEV compared to the LOR LSAM, since the net habitable volumes are the same.

Split-Volume EOR-Direct Return CEV Configuration

Configuring a split-volume vehicle where the CEV is taken to the surface, but an airlock module could be left behind following lunar ascent, proved to be a design challenge. One way to approach this challenge is to invert the CEV so that its docking adapter would be oriented toward the descent stage airlock. This would require the CEV to be configured for partial gravity lunar surface operation in a suboptimal apex-nadir configuration, but this configuration would be suitable for dust control. With a potential split-volume, inverted EOR-direct return CEV design, the team developed an internal layout to assess the feasibility of this configuration. Two initial assumptions that governed the layout were that four crew members should be able to stand together during landing and that there was enough horizontal surface area for four people to sleep. This led to an inverted “wedding cake” layout that provided adequate habitable and equipment volume, as given in the volume analysis detailed in **Section 4.2.3.2.1, CEV and Lunar Surface Access Module (LSAM) Volume Studies**. Human factors engineers constructed a layout within the pressure vessel defined by the CEV engineers. With this layout, it was believed that the equipment and net habitable volumes determined in the volume analysis would not be readily achieved without reconfiguring the vehicle (i.e., utilizing sleep areas for stowage while the crew was awake). The overall concept, shown in **Figures 4-17 and 4-18**, appeared to still be feasible from an initial layout standpoint.

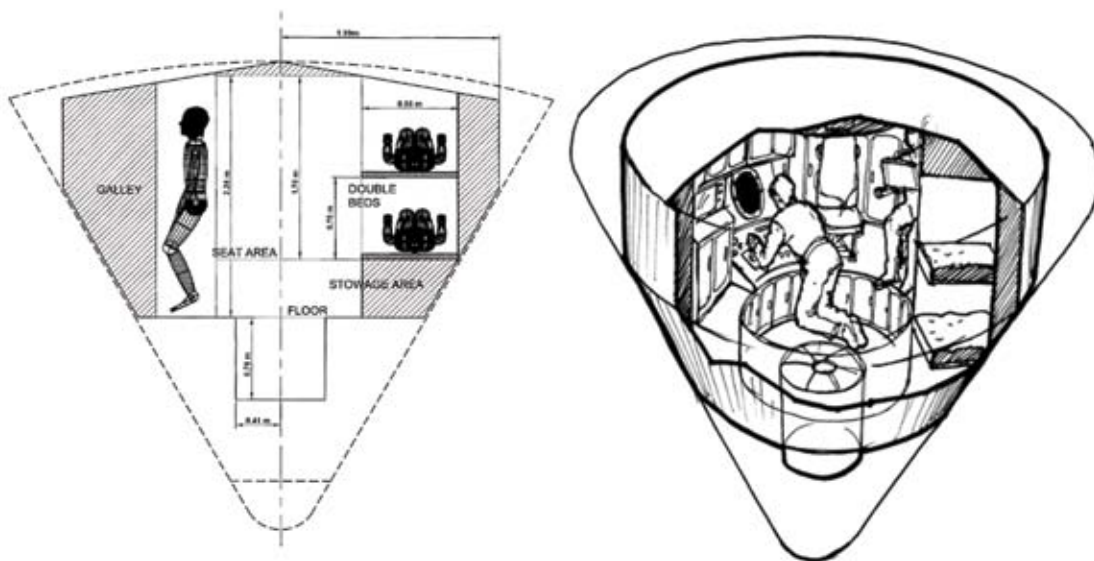
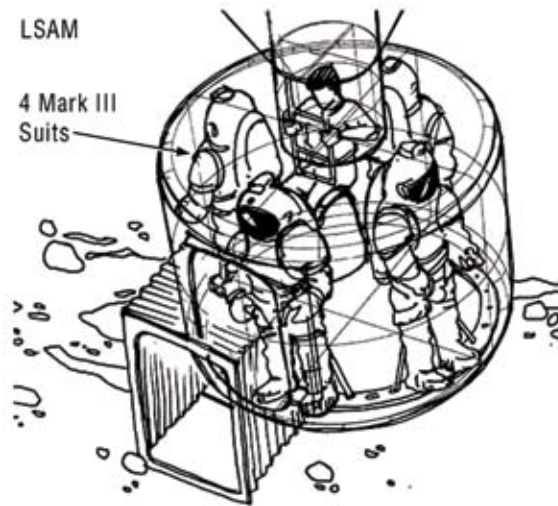

Figure 4-17. Split-Volume EOR-Direct Return CEV Layout

Figure 4-18. Split-Volume EOR-Direct Return CEV Airlock Module



Alternate approaches were investigated with “apex-up” configurations. Placing the airlock on top of the vehicle required it to be far too high off of the lunar surface for safe ingress and egress. Placing the airlock on the side was problematic for CEV Earth ascent and entry configurations.

The team also created layouts for the accompanying airlock module, which would be attached to the bottom of the inverted CEV and used for lunar EVA, including volume for stowage and donning of lunar suits and depress/repress operations. Assumptions for this module were that this would serve as the airlock rather than depressing the entire CEV, lunar suits would most closely resemble the Mark III rear-entry suit, and donning could occur sequentially, with one crew member donning at a time. No CAD models were created for this module, and dimensions were defined by NASA’s Habitability and Human Factors Office (HHFO) to achieve minimal volumes required for the given tasks.

Because the initial resulting volume required for the airlock module was large (16.3 m³ for serial lunar suit donning), the team consulted the experts in EVA operations to explore other lower-volume solutions. It was believed that since only one or two crew members would don suits and depress an airlock at a time, the original four-person layout could be reduced. Several configurations were considered, including two to four one-person suitlocks and a two-person airlock as shown in **Figure 4-19**.

Because the EOR-direct return mission mode is unique, the ESAS team believed it was important to show layouts of the vehicles in different mission phases, including launch, lunar landing, and lunar surface operations. This would illustrate some of the operational complexities of the inverted CEV configuration, which would be “upright” during Earth launch and reentry, but reconfigurable for inverted partial-g operation while on the lunar surface. (Refer to **Figure 4-20**.) These illustrations also point out that a critical docking of the CEV to the lander/airlock module must take place in LEO and must establish all structural, electrical, command, control, and telemetry interfaces between the vehicles.

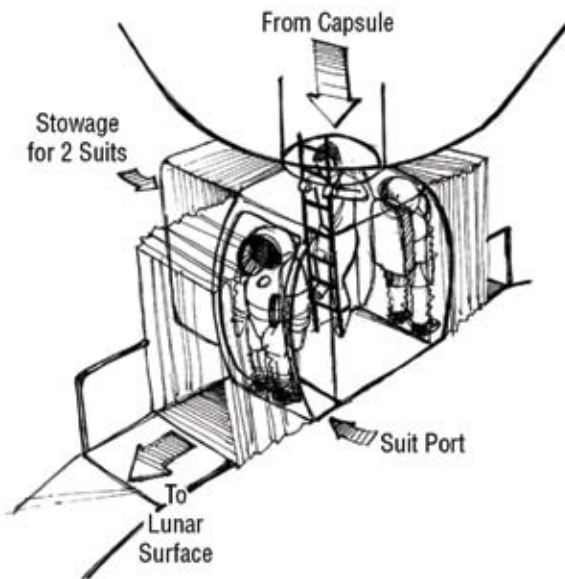

Figure 4-19. Alternative Airlock Module Layout

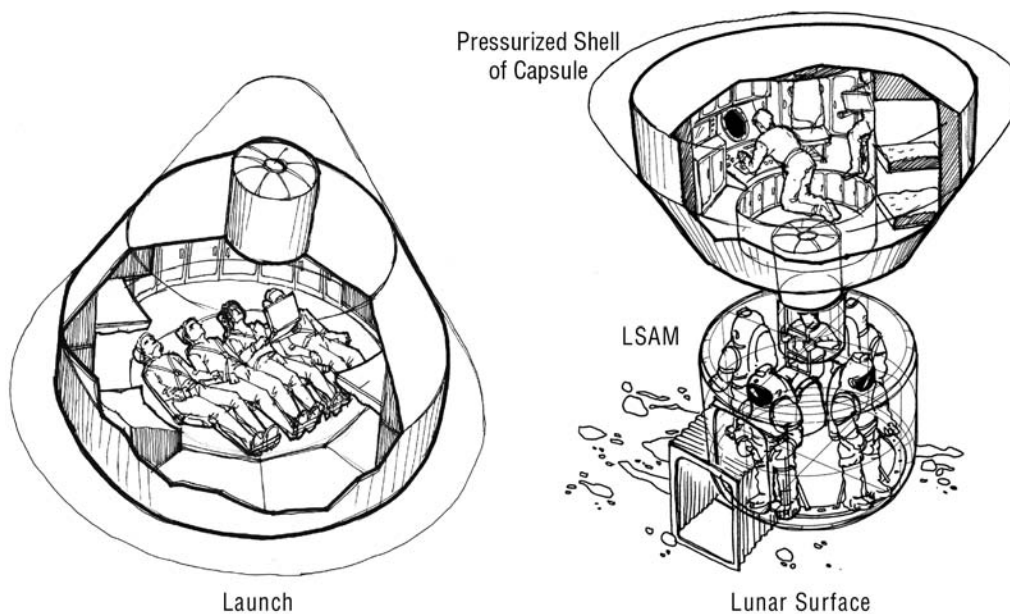

Figure 4-20. Split-Volume EOR-Direct Return CEV + Airlock Module Layout by Flight Phases

Single-Volume EOR-Direct Return CEV Configuration

The team then began to develop a single-volume, “apex-up,” internal layout for a 5.5-m/25-deg single-volume CEV, given a pressure shell with a pressurized volume of 36.6 m³. Because it was believed that depressing the entire module for EVA operations was operationally difficult, studies were conducted to configure an internal airlock within the layout. Lunar dust was identified as a potential problem and an attempt was made to build dust mitigation into the design.

In order to determine the feasibility of this CEV size and shape, specific layout designs were developed, including the location of sleep areas, workstations, airlocks, stowage, and dust mitigation areas. These layouts were intended to be study designs that would represent only one possible solution in order to determine the feasibility of the vehicle volume. Each layout contained a dust mitigation area, with one utilizing a hard wall, and the other utilizing more of a soft wall/curtain concept. Some of the study designs are shown in **Figure 4-21**.

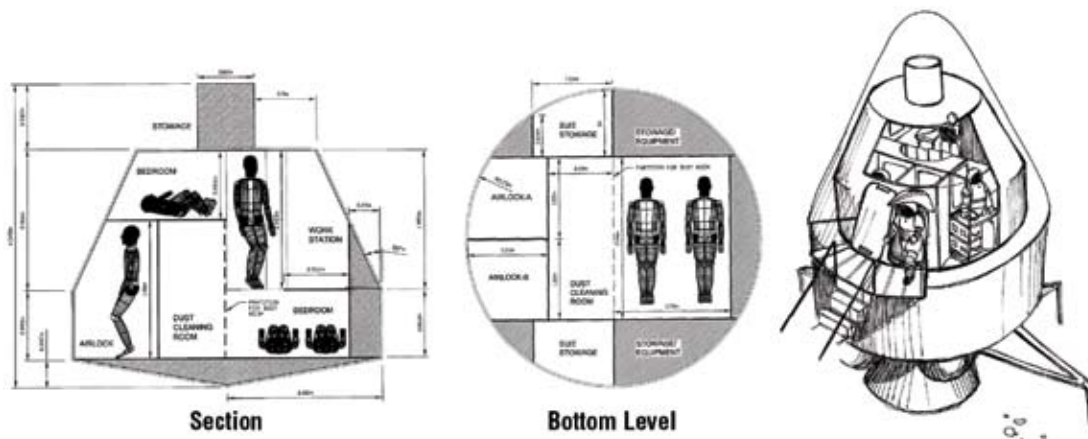

Figure 4-21. Single-Volume CEV Study Design Layouts

Each configuration generally met the volume goals of **Section 4.2.3.2.1, CEV and Lunar Surface Access Module**, although the hard wall concept loses some volume usability since the dust area becomes unusable for any other functions. The ESAS team asked for additional layouts that eliminate the internal airlock, use an updated avionics equipment location from the EX model, and eliminate any “hard walled” partitions. The new avionics layout allowed designers to lower half of the floor to increase habitable volume. This layout (**Figure 4-22**) became the basis of comparison for EOR-direct return missions. The final layouts for the single volume, direct-return CEV are shown in **Figures 4-23** and **4-24**.

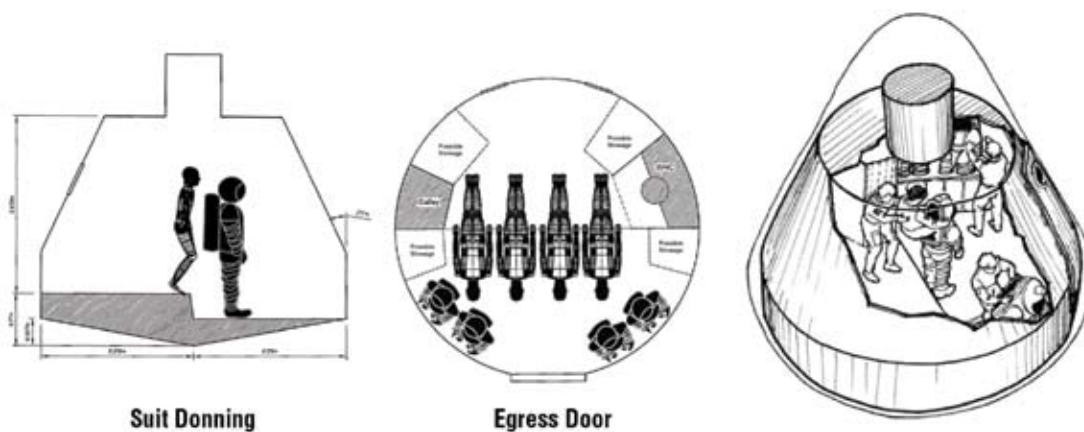

Figure 4-22. Single-Volume EOR-Direct Return Initial Conceptual CEV Layouts

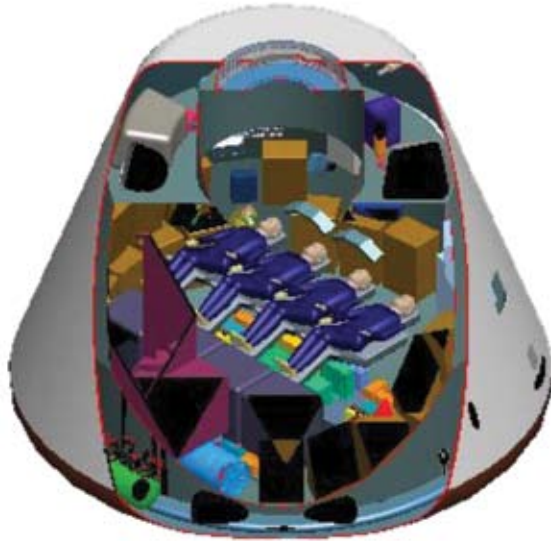

Figure 4-23. EOR-Direct Return CEV CAD Cutaway Showing Four-Crew Earth Launch Configuration



Figure 4-24. EOR-Direct Return CEV CAD Section Showing Lunar Ascent and Descent Pilot Position

Conclusions

The EOR-direct return mission mode has substantial design and risk implications to the CEV design. The surface-direct mission requires greater volume than other mission modes, and this volume could be implemented either in a single- or split-volume configuration. The split-volume configuration offers an intriguing opportunity to deploy a habitable surface element (the airlock module) each time a sortie mission visits the surface, but also subjects the CEV to inverted landing and adds significant weight and complexity. Although the ESAS team did not perform a comprehensive analysis of how the CEV internal arrangement would be reconfigured for lunar ascent, descent, and surface operations, it was clear that this would add substantial design complexity to the vehicle and operational complexity for the crew.

The configuration study also concluded that the integration of an airlock, either within the CEV or supplemental to the CEV, would add complexity and mass to the design. Control of lunar dust has implications in protecting the vehicle subsystems for future use, and the additional airlock mass could make the direct mission mode infeasible for launching on two vehicles. For this reason, the ESAS team recommended a focused study to determine the need for a surface airlock.

4.2.4.1.4 Airlock Trade Study

Process

This study was conducted to generate the information required to support a decision on whether to include an airlock in the LSAM. The information generated during this task drew heavily on findings from recent ESMD studies. Using these studies as a starting point, the ESAS team refined the analysis using inputs from the ESAS lunar architecture.

The ESAS team focused primarily on the hazards and contingencies that an airlock would mitigate. In doing so, the team first agreed on the set of hazards and contingencies to which an airlock was a solution. Next, the team systematically assessed each hazard/contingency, listed alternate solutions, and described the end-state that each solution provided. It was found that an airlock placed on the LSAM would protect against two major classes of problems:

- Constant: Dust, and
- Contingencies: Illness, injuries, suit malfunctions.

Dust is a quantifiable, known problem that must be controlled. The Apollo astronauts found that dust posed a hazard to hardware and crew health. Transcripts and anecdotal comments from Apollo astronauts describe the magnitude of the problem posed by dust, which permeated the crew cabin, covered EVA suits/tools, and soiled the field experiment hardware. It also proved to be a source of respiratory and eye irritation for a number of the crew members.

Contingency scenarios were considered in terms of likelihood, vehicle design/operations options, and mission/crew risk. Many of the contingency situations considered had a low likelihood of occurring. Furthermore, many of the contingencies had either vehicle design and/or operational work-arounds that did not carry the mass and configuration impacts that an airlock would impose. For each work-around, the impacts to mission and crew risks were assessed. Coupled together, this information provided the necessary insight to assess the risk posed by the contingencies. In the end, the decision is largely based on the level of risk that the program is willing to accept.

Finally, while hazard and contingency mitigation was the focus of this study, mention should be made to the operational flexibility that would be gained if an airlock were to be included in the LSAM configuration. The primary operational benefit afforded by an airlock is that it allows for split-crew operations, which can be advantageous in at least two major scenarios. First, it allows one team to conduct an EVA while the other team remains inside the vehicle with suits doffed (perhaps safing the LSAM after landing or prepping the vehicle prior to lunar-surface-departure). Secondly, it allows multiple EVA teams to “split off” in different directions on the lunar surface and return to the LSAM when their team’s tasks are complete, without being required to wait for the other team(s) to complete their tasks.

Results

The hazards/contingencies, alternative solutions, and respective end-states that were considered are shown in **Table 4-10**.

Table 4-10. Hazards/
Contingencies,
Alternative Solutions, and
Respective End-states

Problem	Time Period	Comments	Mitigation or Solution	End-State
Dust	Constant	Solution must meet Spacecraft Maximum Allowable Concentration (SMAC) limits and hardware design specs.	Airlock	Majority of dust is controlled.
			Separate volume (without airlock capabilities)	
			Dust removal method prior to ingress.	
Crew member illness or injury	Prior to donning suit	Needs a solution: too ill/injured to don suit, but not ill/injured enough to merit a return to Earth.	Airlock—crew member remains inside crew cabin.	Ill/injured crew member refrains from EVA. No LOM.
			Internal pressurized volume houses affected crew member.	
			Cease all EVAs until illness/injury subsides.	Mission continuance depends on status of ill/injured crew member.
	During EVA	Crew member needs to return to lander and doff suit.	Airlock—crew member ingresses lander.	Other crew members' activities are unaffected. No LOM.
			Crew member ingresses internal pressurized volume.	
			Operationally constrain EVA traverse distances and distances between EVA teams.	All crew members return to lander together. Mission continuance depends on status of affected crew member.
Suit malfunction	Prior to initiation of lunar descent	Assume problem is too big to fix with available tools/parts.	Airlock—crew member remains inside crew cabin.	All crew, except affected crew member, performs EVA. No LOM.
			Internal pressurized volume houses affected crew member.	
			Affected crew member uses launch/ascent suit.	Return to Earth
		Mission is scrubbed.		
	Assume problem can be fixed with available tools/parts.	Airlock—crew member remains inside crew cabin to fix suit.	All crew members perform EVA; affected crew member joins when ready. No LOM.	
		Internal pressurized volume houses affected crew member while fixing suit.		
Scrub EVA until suit is fixed.		All EVA scrubbed until suit is fixed. No LOM.		

Table 4-10. (continued)
 Hazards/Contingencies,
 Alternative Solutions, and
 Respective End-states

Problem	Time Period	Comments	Mitigation or Solution	End-State
Suit malfunction	Prior to egress from lander for EVA	Assume problem is too big to fix with available tools/parts.	Airlock—crew member stays inside crew cabin.	All crew, except affected crew member, performs EVA. No LOM.
			Internal pressurized volume houses affected crew member.	
			Affected crew member remains inside lander using launch/ascent suit.	
			Mission is scrubbed.	
		Assume problem can be fixed with available tools/parts.	Airlock—crew member fixes suit in crew cabin.	All crew members perform EVA; affected crew member joins when ready. No LOM.
			Internal pressurized volume provides area for crew member to fix suit.	
	Scrub EVA until suit is fixed.		All EVA scrubbed until suit is fixed. No LOM.	
	During EVA	Catastrophic suit failure	None	Loss of crew member.
		Assume major failure—can be contained or controlled in order to allow crew member to return to lander, but with no time to spare.	Airlock—crew member ingresses lander.	Other crew members' activities are unaffected. No LOM.
			Crew member ingresses internal pressurized volume.	
			Crew member ingresses lander and dons launch/ascent suit.	Conditional work-around—time required to doff, repressurize cabin, and switch suits.
			Operationally constrain EVA traverses.	All crew members return to lander together. Mission continuance depends on status of affected crew member.
		Assume minor failure—can be contained or controlled, allowing crew member to return to lander with time to spare.	Airlock—crew member fixes suit in crew cabin.	All crew members perform EVA; affected crew member joins when ready. No LOM.
			Internal pressurized volume provides area for crew member to fix suit.	
Suit is connected to umbilical to resupply.			Conditional work-around—Applicable if malfunction is consumables-related. Consumables must be available.	
Affected crew member ingresses lander, repressurizes, and dons launch/ascent suit.	Conditional work-around—time required to doff, repressurize cabin, and switch suits.			
Operationally constrain EVA traverse distances and distances between EVA teams.	All crew members return to lander together. Mission continuance depends on status of affected crew member.			

In listing the hazards/contingencies, it was necessary to also list the time period during which the hazard/contingencies might occur. For example, it would not have been practical to list “injured crew member” and then try to find mitigation techniques that served as alternatives to airlocks. Instead, it was necessary to define whether the injury occurred in the crew cabin prior to donning an EVA suit or whether the injury occurred while on EVA. The available solutions and end-states to these two problems were different. Additionally, if the latter were to occur, the former would still require a solution for the injured crew member, but not vice versa.

An example of a potential problem that required further definition is in consideration of a “crew member illness or injury.” This problem only required a solution if the crew member

was too ill or injured to don a suit, but not ill or injured to the point to merit a return to Earth. Obviously, this significantly limited the severity of the illnesses or injuries under consideration and centered the discussion on the likelihood of such an illness or injury. Another example of a problem that required further analysis can be found in the discussion of a “suit malfunction.” This problem required that the team examine solutions to malfunctions that were too large to fix, as well as those that could be fixed in-situ. Again, the available solutions and end-states to these two classes of problems were different.

Finally, for each hazard/contingency, viable work-arounds were found. As previously stated, many of these work-arounds did not carry the mass and configuration impacts that an airlock would impose. However, when taken together and when the operational flexibility afforded by an airlock was considered, it was felt that a strong case could be made for the inclusion of an airlock in the LSAM configuration.

Ultimately, the decision to include an airlock in the LSAM configuration is largely dependent on the level of risk the program is willing to accept. As such, it must be made in the context of the key mission parameters and program guidance, as defined by the ESAS team and included below:

- There will be multiple sortie missions in the lunar program.
- All other missions (potentially spanning decades) will be to the vicinity of a habitat or some other pressurized element. In this situation, the crew will egress the lander on landing and ingress the lander at the end of the surface mission. The assumption can be made that, during these types of missions, the lander will not be ingressed nor egressed more than this.
- There will be four EVA crew members.
- The surface mission duration may extend up to 7 days.
- EVA by all crew members is assumed on at least 4 days.
- As currently defined, the lunar sortie surface mission objectives are to perform science, demonstrate the transportation system, opportunistic technology demonstration, and opportunistic surface operations demonstration.

Based on the information in this study, the ESAS team ultimately advised that an airlock be included in the LSAM configuration. Though each of the issues identified in this study (suit malfunction, crew illness, and dust control) could be potentially solved by a combination of cleaning equipment, suit spares, umbilical capability, and operational constraints, the sum of these issues would impose difficult operational requirements on the lunar surface mission. Thus, although a surface airlock is not strictly required, the ESAS team concluded that it is strongly desirable.

The study also concluded that incorporating an airlock into the LSAM crew cabin is easily workable; however, adding an airlock to a CEV is difficult. In particular, adding an airlock to a direct return CEV will consume all available mass margin and further complicate the configuration of the CEV used for this mission mode. An inverted CEV with a separate airlock mounted below the CEV appeared feasible if mass margin allows the addition of a second pressurized volume. In general, airlocks become more essential as the number of ingress/egress cycles increase. The ESAS team concluded that, for a lander that simply rotates crew to an outpost, an airlock is not required; for 7-day sortie-class accessibility, an airlock is strongly desired; and, for an outpost mission, an airlock is essential.

4.2.4.2 Cycle 2 Performance

Based on the FOM analysis comparing the Cycle 1 architectures, the EOR–LOR with CEV-to-surface architecture was eliminated from future consideration. Design Cycle 2 subsequently focused on the remaining three options: (1) LOR (EIRA), (2) EOR–LOR, and (3) EOR-direct return. In this cycle, a uniform CEV capsule shape was also used for comparing architectures. The selected shape was the 5.5-m diameter, 25-deg sidewall angle used in Cycle 1 EOR-direct return. Previously, the two LOR architectures had assumed the smaller-volume 5.0-m diameter, 30-deg shape. Design Cycle 2 also introduced the potential for including more advanced propulsion technology than pressure-fed oxygen/methane in the various architecture elements, as well as an analysis of eliminating the supplemental 5 g/cm² of HDPE radiation shielding on the CEV. The advanced propulsion options included using a pump-fed oxygen/hydrogen system on the LSAM descent stage and using pump-fed oxygen/methane on the ascent and return systems.

Figure 4-25 shows a comparison of LOR, EOR–LOR, and EOR-direct return normalized IMLEO for the design options analyzed in Cycle 2. The data on the far left of the figure represents normalized mass using the same assumptions as Cycle 1, with the exception that the two LOR architectures use the same CEV CM shape as EOR-direct return. This change has caused the total mass of these architectures to increase above that which was illustrated previously in **Figure 4-8** of **Section 4.2.3, Analysis Cycle 1 Mission Mode Analysis**, while the direct return option has remained relatively constant. The slight increase is due to additional fidelity in the vehicle designs. The remaining three data sets illustrate how architecture mass decreases with increasing propulsion technology and the elimination of supplemental radiation protection. When polyethylene shielding is removed from the CEV (1,860 kg), the total mass for all three architectures decreases, though the greatest reduction is seen in EOR-direct return. This was expected because mass reduction on the CEV has the greatest leverage on the overall architecture when the vehicle transits all the way to the lunar surface and then returns to Earth, rather than only transiting to and from the lunar orbit.

The next set of analyses focused on the effect of incorporating pump-fed oxygen/hydrogen propulsion (rather than pressure-fed oxygen/methane) into the LSAM descent stage. Such a system enables propellant mass savings by significantly increasing the engine Isp and reducing the mass of propellant and pressurization fluid storage. Once again, all three architecture alternatives achieve a significant mass reduction, while EOR-direct return is most affected. Interestingly, this change enables EOR–LOR to now have a slightly lower normalized IMLEO than LOR. In Cycle 1, the lowest mass EOR–LOR mission design required the CEV to perform the LOI maneuver for both the CEV and LSAM. When a pump-fed oxygen/hydrogen system is available on the descent stage, it is more effective to use this stage (rather than the pressure-fed oxygen/methane system) for LOI on the CEV. Finally, the option to use a pump-fed oxygen/methane system is introduced for the ascent and TEI maneuvers in the final set of architecture masses. **Figure 4-25** clearly demonstrates that this particular propulsion technology has a relatively minor impact on the architectures using LOR as compared to the previous design changes and the savings achieved with pump-fed return in EOR-direct return. The effect of slightly higher Isp and lower inert mass with pump-fed systems is more pronounced when the stage in question is performing as much delta-V as possible or is transporting as much mass as possible. The ascent and return function with EOR-direct return is combined into a single stage performing the entire delta-V required, while the total delta-V with LOR is

performed by two stages (with each allocated a portion of the total). Thus, one would expect pump-fed return propulsion to reduce normalized IMLEO for the EOR-direct return architecture more than the other two architectures. **Figure 4-25** also shows that, when all propulsion technologies are applied and supplemental radiation shielding is removed from the CEV, EOR-direct return has an IMLEO only 15 percent higher than LOR or EOR-LOR.

Another important metric to use when evaluating competing architectures is the amount of additional mass margin each provides. This metric is a measure of an architecture’s flexibility and robustness. For example, mass margin on a given element could be used to cover future

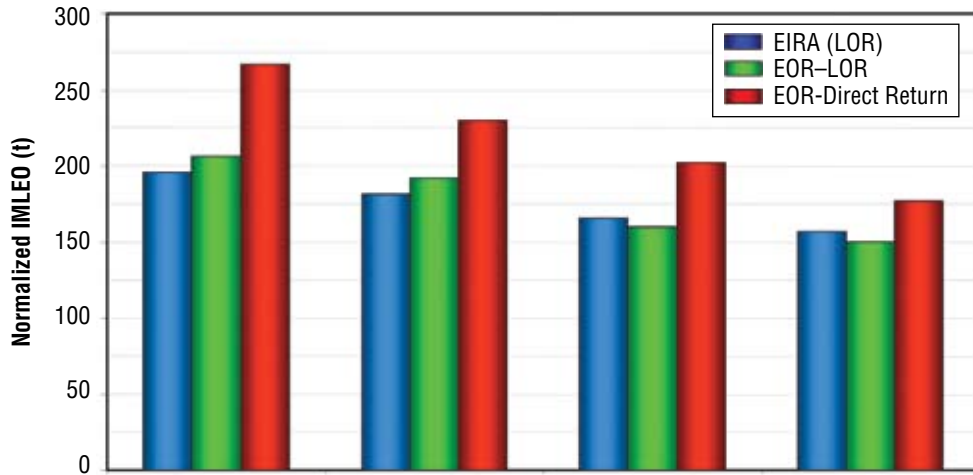





CEV Radiation	+1.8 t Supplemental Polyethylene Shielding	No Supplemental Shielding	No Supplemental Shielding	No Supplemental Shielding
Descent Propulsion	LOX/Methane Pressure-Fed	LOX/Methane Pressure-Fed	LOX/Hydrogen Pump-Fed	LOX/Hydrogen Pump-Fed
Return Propulsion	LOX/Methane Pressure-Fed	LOX/Methane Pressure-Fed	LOX/Methane Pressure-Fed	LOX/Methane Pump-Fed

Figure 4-25. Normalized Architecture IMLEO with Increasing Propulsion Technology

mass growth, add additional capability within the vehicle’s subsystems, or transport additional useful cargo to or from a destination. For example, if the CEV radiation protection was eliminated, oxygen/hydrogen was used in the LSAM descent stage, and no elements exceeded their mass allocations (over and above the 20 percent dry weight margin already included), the descent stage could land an additional 6,450 kg of useful cargo on the lunar surface if the EOR-LOR architecture was selected. **Table 4-11** shows the amount of additional mass margin available for any one element in the three architecture alternatives without exceeding allowable launch limits. Only 2-launch architecture solutions were considered and, as illustrated in **Table 4-11**, even when the CEV supplemental radiation shielding is removed, EOR-direct return is still a 3-launch solution for the all-pressure-fed methane propulsion cases. The baseline EOR-LOR mission, with the larger CEV CM than was used in Cycle 1, may also be considered a 3-launch solution because all elements have negative margin. All architectures are 2-launch solutions and have positive margins when pump-fed oxygen/hydrogen is incorporated in the descent stage. However, while LOR and EOR-LOR have robust margins with only this propulsion technology, EOR-direct return also requires pump-fed methane for ascent and return for a comparable level of architecture margin.

Table 4-11. Margins for Cycle 2 Architectures

Technology Switch	CH4 Ascent/TEI	CH4 Ascent/TEI	CH4 Ascent/TEI	Pump-Fed CH4 Ascent/TEI
	CH4 Descent	CH4 Descent	H2 Descent	H2 Descent
	CEV Radiation Protection	No Supplemental Protection	No Supplemental Protection	No Supplemental Protection
	+1,330 kg (LOR)	+3,190 kg (LOR)	+3,190 kg (LOR)	+4,100 kg (LOR)
	-1,250 kg (EOR–LOR)	+600 kg (EOR–LOR)	+5,040 kg (EOR–LOR)	+6,730 kg (EOR–LOR)
	N/A (Direct)	N/A (Direct)	+240 kg (Direct)	+1,970 kg (Direct)
	+1,600 kg (LOR)	+3,830 kg (LOR)	+3,830 kg (LOR)	+4,910 kg (LOR)
	-1,500 kg (EOR–LOR)	+730 kg (EOR–LOR)	+6,050 kg (EOR–LOR)	+8,060 kg (EOR–LOR)
	N/A (Direct)	N/A (Direct)	+290 kg (Direct)	+2,360 kg (Direct)
	+330 kg (LOR)	+330 kg (LOR)	+1,740 kg (LOR)	+2,160 kg (LOR)
	-710 kg (EOR–LOR)	+350 kg (EOR–LOR)	+3,230 kg (EOR–LOR)	+4,340 kg (EOR–LOR)
	+1,120 kg (LOR)	+1,120 kg (LOR)	+3,200 kg (LOR)	+4,270 kg (LOR)
	-1,320 kg (EOR–LOR)	+1,140 kg (EOR–LOR) N/A (Direct)	+6,450 kg (EOR–LOR)	+8,060 kg (EOR–LOR)
	N/A (Direct)	N/A (Direct)	+1,300 kg (Direct)	+5,600 kg (Direct)

4.2.4.2.1 Launch EOR–LOR Architecture

The combination of advanced propulsion technology on the LSAM and CEV and additional ascent and injection mass performance with an upgraded CLV introduced another architecture variant in Design Cycle 2. This variant, known as 1.5-launch EOR–LOR, is so named due to the large difference in size and capability of the LVs used in the architecture. Whereas the previous architectures have used one heavy-lift Cargo Launch Vehicle (CaLV) to launch cargo elements and another heavy-lift Crew Launch Vehicle (CLV) to launch the CEV and crew, this architecture divides its launches between one large and one relatively small LV. The 1.5-launch EOR–LOR mission is an EOR–LOR architecture with the LSAM and EDS pre-deployed in a single launch to LEO with the heavy-lift CaLV. A second launch of a 25-mT-class CLV delivers the CEV and crew to orbit, where the two vehicles initially rendezvous and dock. The EDS then performs the TLI burn for the LSAM and CEV and is discarded. On reaching the Moon, the LSAM performs the LOI for the two mated elements, and the entire crew transfers to the LSAM, undocks from the CEV, and performs descent to the surface. The CEV is left unoccupied in LLO. After up to 7 days on the lunar surface, the LSAM returns the crew to lunar orbit, where the LSAM and CEV dock and the crew transfers back to the CEV. The CEV then returns the crew to Earth with a direct- or skip-entry-and-land touchdown while the LSAM is disposed via impact on the lunar surface. The 1.5-launch EOR–LOR architecture is illustrated in **Figure 4-26**.

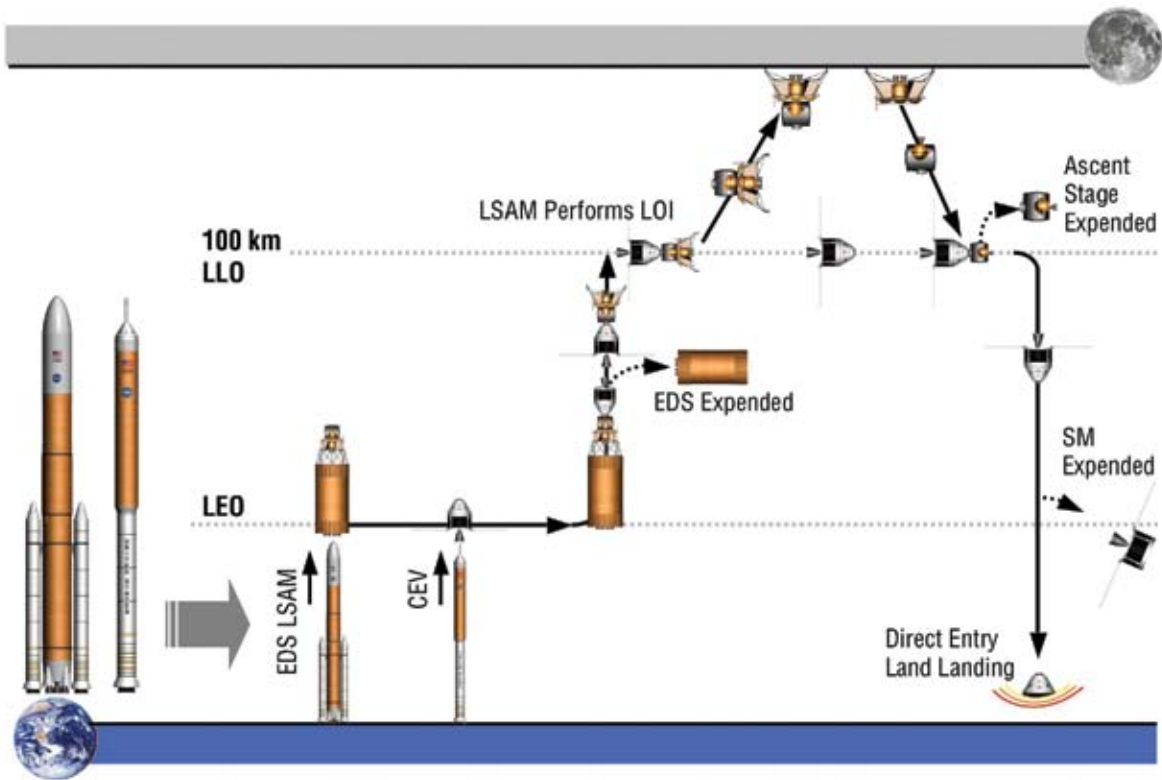

Figure 4-26. 1.5-Launch EOR-LOR Architecture

Similar to EOR-direct return, the 1.5-launch EOR-LOR requires both a hydrogen pump-fed descent stage and the removal of supplemental CEV radiation protection to achieve a 2-launch architecture. Even when these measures are taken, the architecture still has slightly negative EDS performance margin as shown in **Table 4-12**. This table provides a 4x4 matrix of EDS performance margins for the four technology alternatives and four architecture alternatives. The individual launch masses for the LSAM and CEV are also provided.

Table 4-12. EDS
Performance Margins

Technology Switch		CH4 Ascent/TEI	CH4 Ascent/TEI	CH4 Ascent/TEI	Pump-Fed CH4 Ascent/TEI
		CH4 Descent	CH4 Descent	H2 Descent	H2 Descent
		CEV Radiation Protection	No Supplemental Protection	No Supplemental Protection	No Supplemental Protection
LOR (EIRA)	2-launch solution -5.5-m CEV -5-Segment SRB In-line w/4 SSME	LSAM: 27.9 t CEV: 26.2 t Required: 27.9 t to TLI+LOI EDS Limit: 29.1 t	LSAM: 27.9 t CEV: 22.2 t Required: 27.9 t to TLI+LOI EDS Limit: 29.1 t	LSAM: 23.6 t CEV: 22.2 t Required: 23.6 t to TLI+LOI EDS Limit: 29.1 t	LSAM: 22.6 t CEV: 20.7 t Required: 22.6 t to TLI+LOI EDS Limit: 29.1 t
	2-launch solution -5.5-m CEV -5-Segment SRB In-line w/ 4 SSME	LSAM: 27.1 t CEV: 64.6 t Required: 89.9 t to TLI Limit: 85.6 t	LSAM: 27.1 t CEV: 57.9 t Required: 83.5 t to TLI Limit: 85.6 t	LSAM: 46.1 t CEV: 24.4 t Required: 69.6 t to TLI Limit: 85.6 t	LSAM: 46.1 t CEV: 24.4 t Required: 69.6 t to TLI Limit: 85.6 t
EOR-LOR	1.5-launch solution -5.5-m CEV -5-Segment SRB In-line w/5 SSME + 2 J2-S -4-Segment RSRB w/1 SSME	3 Launches Required		LSAM: 46.9 t CEV: 21.8 t Required: EDS + 44.9 t to LEO, 65.5 t to TLI Limit: 63.8	LSAM: 42.8 t CEV: 20.3 t Required: EDS + 42.8 t to LEO, 61.9 t to TLI Limit: 65.5 t
	2-launch solution -5.5-m CEV -5-Segment SRB In-line w/4 SSME			LSAM: 50.2 t CEV: 34.9 t Required: 83.8 t to TLI Limit: 85.6 t	LSAM: 44.1 t CEV: 30.0 t Required: 73.3 t to TLI Limit: 85.6 t
EOR-Direct Return					

4.2.4.2.2 Lunar Cargo Transport

Design Cycle 2 also analyzed each architecture’s ability to deliver large cargo elements to the lunar surface using the LSAM descent stage and EDS as one-way, uncrewed transportation systems. The LOR and 1.5-launch EOR–LOR architectures are best suited for cargo delivery in a single launch, since the LSAM and EDS are nominally launched together for the crewed mission and one of those two elements performs LOI. The LOR architecture CaLV can land up to 18 t of cargo on the lunar surface in a single launch, while the 1.5-launch EOR–LOR architecture CaLV can land 20.9 t in a single launch. This extra 3 t of capability is due to the larger, higher-performance CaLV. EOR-direct return is instead better suited for delivering cargo in two launches because the LSAM nominally launches separate from the large EDS in the crewed mission. While this architecture does require a second launch to land cargo on the lunar surface, the landed payload capability is nearly doubled to 34.7 t. Finally, EOR–LOR is best suited for either single-launch or 2-launch cargo delivery, depending on the level of propulsion technology assumed. When pressure-fed methane is used in the descent stage, the CEV is used to perform LOI and the descent stage only performs descent from LLO. Therefore, it is more efficient to package the cargo and descent stage with the EDS and only require a single launch for cargo delivery. If pump-fed hydrogen is used instead, the LSAM nominally performs LOI and descent. In this case, the architecture is better suited for 2-launch cargo delivery similar to EOR-direct return. The maximum cargo delivery capability is identical for the two architectures. **Table 4-13** provides the maximum cargo mass for each architecture option.

Table 4-13 . Cycle 2 Architecture Cargo Delivery Capability

Technology Switch		CH4 Ascent/TEI	CH4 Ascent/TEI	CH4 Ascent/TEI	Pump-Fed CH4 Ascent/TEI
		CH4 Descent	CH4 Descent	H2 Descent	H2 Descent
		CEV Radiation Protection	No Supplemental Protection	No Supplemental Protection	No Supplemental Protection
LOR (EIRA)	2-Launch solution -5.5-m CEV -5-Segment SRB In-line w/ 4 SSME	15.2 t (Single HLLV Launch)	15.2 t (Single HLLV Launch)	18.0 t (Single HLLV Launch)	18.0 t (Single HLLV Launch)
EOR-LOR	2-Launch solution -5.5-m CEV -5-Segment SRB In-line w/ 4 SSME	14.4 t (Single HLLV Launch)	14.4 t (Single HLLV Launch)	34.7 t (Two HLLV Launches)	34.7 t (Two HLLV Launches)
	1.5-Launch solution -5.5-m CEV -5 Segment SRB In-line w/ 5 SSME + 2 J2-S -4-Segment RSRB w/1 SSME	3 Launches Required		20.9 t (Single HLLV Launch)	20.9 t (Single HLLV Launch)
EOR-Direct Return	2-Launch solution -5.5-m CEV -5-Segment SRB In-line w/ 4 SSME			34.7 t (Two HLLV Launches)	34.7 t (Two HLLV Launches)

4.2.4.3 Figures of Merit

The performance analysis contained in the previous section is a good first-order indicator of mission mode viability and was used to examine the three mission modes studied in the second analysis cycle. In order to paint a complete picture of the trade space, however, an examination of additional FOMs is required. Design, Development, Test, and Evaluation (DDT&E), production, and operations costs were calculated for each of the options, as well as integrated LCCs. These detailed results and the methods used are discussed in **Section 9, Technology Assessment**. Similarly, safety and reliability calculations were performed for each option in the form of probability of loss of crew (LOC) (P(LOC)) and probability of loss of mission (LOM) (P(LOM)). These detailed results and the methods used are discussed in **Section 8, Risk and Reliability**. The ESAS team established a rigorous system to conduct the cost, reliability, and safety studies with common assumptions, performance data, and operational concepts for each of the options. The end results are comparative analyses that accurately capture the relative cost and risk differences among the options.

Figure 4-27 graphs the 20-year LCCs of the various mission options from 2006 to 2025. “Low-tech,” “half-tech,” and “All-tech” on this graph refer to the three propulsion options studied in this analysis cycle—all pressure-fed LOX/LCH4 engines for lander descent and ascent, LOX/LH2 descent with LOX/LCH4 ascent, and LOX/LH2 descent with pump-fed LOX/LCH4 ascent, respectively. The graph suggests that the lander propulsion technology, while having a great effect on performance, has little effect on the program LCC. One anomalous data point that stands out is the “1.5-launch” EOR-LOR mission mode, which differed from the remainder of the options that were costed by using a single Solid Rocket Booster (SRB) for crew launches with a second stage based on a J2-S engine. This result seemed counterintuitive, given that a smaller LV was substituted for a larger booster, and prompted the team to analyze this further in the next analysis cycle.

Figure 4-27. Analysis
Cycle 2 Mission Mode
LCC Comparison
through 2025

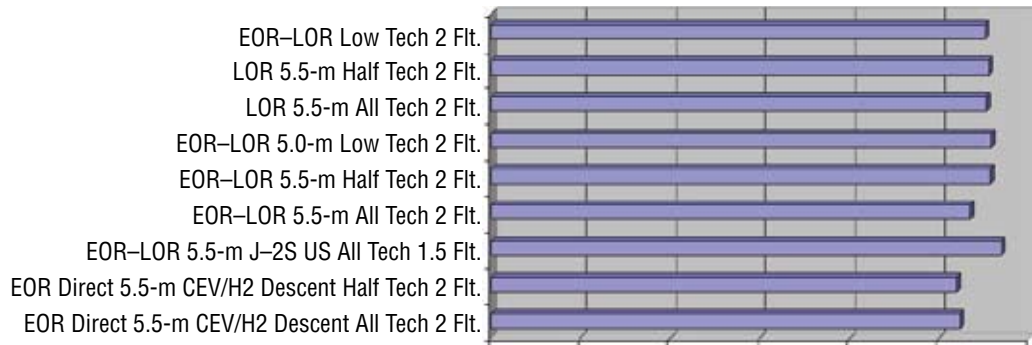

LOC and LOM analyses provided better separation among the mission mode options. Generally, as more advanced propulsion technology was added, both P(LOM) and P(LOC) increased, as shown in Figures 4-28 and 4-29. Comparing mission mode options, EOR-direct return returned the best reliability numbers, likely owing to the fewer number of operations required for this mission mode, though the risk analyses did not take into account any surface operations. EOR-LOR options were shown to be the safest, returning P(LOC) numbers that were on the order of half of LOR missions. The risk metric that captured the ESAS team’s attention, however, was the safety and reliability performance of the 1.5-launch EOR-LOR mission relative to any other LOR or EOR-LOR option. For this reason, the team chose to do more in-depth analysis of the 1.5-launch solution.

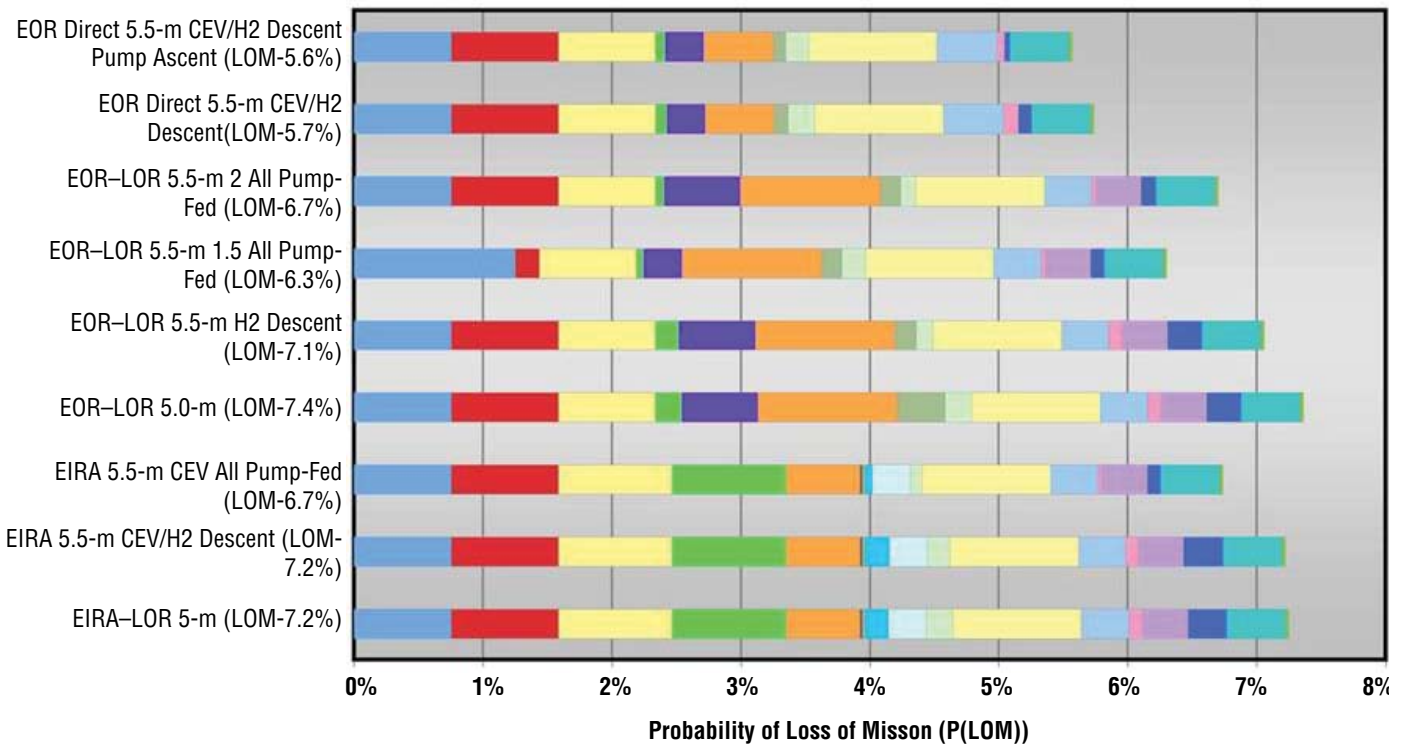

Figure 4-28. Analysis
Cycle 2: LOM
Comparison

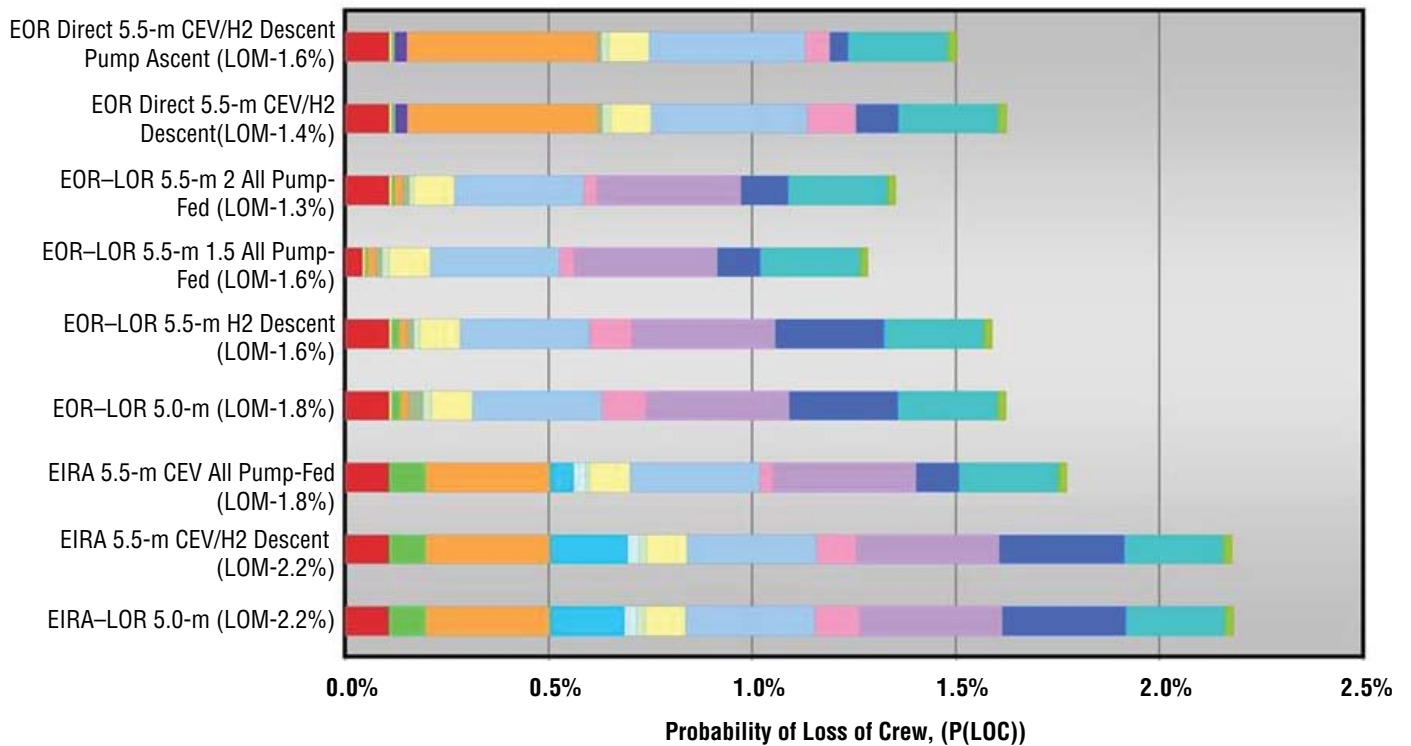

Figure 4-29. Analysis Cycle 2: LOC Comparison

In addition to technical performance, cost, safety, and reliability, the ESAS team also sought to quantify the mission modes with a table of other FOMs, including architecture flexibility, extensibility (to Mars and beyond), effectiveness, and operability. **Tables 4-14** and **4-15** are much-condensed versions of spreadsheets that combined qualitative and quantitative measures for dozens of additional FOMs for the three mission mode options. FOMs that discriminated between the 2-launch and 1.5-launch EOR-LOR options were noted separately in the EOR-LOR row.

Table 4-14. Analysis
Cycle 2 Flexibility and
Extensibility FOMs

	Pro	Con
LOR	<ul style="list-style-type: none"> • Mars architecture is also a “split”/orbit rendezvous mission; • Enables single-launch missions to other near-Earth destinations (e.g. Mars Transfer Vehicle (MTV) orbit, LLO, libration points, Geosynchronous Earth Orbit (GEO), etc.); and • More reliable single-launch cargo delivery to lunar surface. 	<ul style="list-style-type: none"> • Largest indivisible surface cargo element limited to <20 t.
EOR-LOR	<ul style="list-style-type: none"> • Mars architecture is also an orbit rendezvous mission; • The 1.5-launch solution provides more reliable single-launch cargo delivery to lunar surface; and • Provides ability to land large monolithic surface cargo elements. 	<ul style="list-style-type: none"> • Cargo delivery requires two launches and an uncrewed large element AR&D (except 1.5-launch solution); and • 1.5-launch solution has little margin for potential vehicle mass growth with current launch vehicles; and • Requires pump-fed ascent or more expensive, less reliable launchers for additional performance.
EOR-Direct Return	<ul style="list-style-type: none"> • Larger ascent stage provides greatest leverage for lunar ISRU; and • Provides ability to land large monolithic surface cargo elements. 	<ul style="list-style-type: none"> • Cargo delivery requires two launches and an uncrewed large element AR&D; • EOR-direct return has little margin for potential vehicle mass growth with current LVs; • Requires pump-fed ascent or more expensive, less reliable launchers for additional performance; and • EOR-direct return is highly sensitive to mass growth in the CEV CM and SM.

Table 4-15. Analysis
Cycle 2 Effectiveness,
Performance, and
Operability FOMs

	Pro	Con
LOR	<ul style="list-style-type: none"> • Lander crew cabin is better configured for supporting sortie missions beyond 7 days; • Relatively simple to incorporate an airlock in LSAM; and • No TLI departure window constraints for outpost missions. (Sortie missions are similar to EOR.) 	<ul style="list-style-type: none"> • Current transportation architecture limited to near-polar or equatorial outpost locations; and • Plane change delta-V costs with “anytime return” capability and global access drastically increase beyond 4–7 days.
EOR-LOR	<ul style="list-style-type: none"> • Lander crew cabin is better configured for supporting sortie missions beyond 7 days; • Lander volume available on outbound trip for improved habit ability; and • Relatively simple to incorporate an airlock in LSAM → operational flexibility. 	<ul style="list-style-type: none"> • Current transportation architecture limited to near-polar or equatorial outpost locations; • Plane change delta-V costs with “anytime return” capability and global access drastically increase beyond 4–7 days; and • Large, tall descent stage; and • Cargo unloading more challenging.
EOR-Direct Return	<ul style="list-style-type: none"> • Transportation system delta-V costs independent of landing site location or stay time (global access/anytime return capability). 	<ul style="list-style-type: none"> • Large, tall descent stage; • Cargo unloading more challenging; • Most difficult crew egress path from crew cabin to lunar surface; and • Adding an airlock to the CEV is a very difficult configuration challenge and added mass may exceed available margins.

4.2.4.4 Findings and Forward Work

A tremendous amount of technical, cost, and risk analysis was accomplished by the end of Cycle 2 of the ESAS. Higher-efficiency lander propulsion became of particular interest as performance analysis showed that it enabled both 2-launch direct return and 1.5-launch EOR–LOR solutions. It was recognized that the engine development for the CEV ascent stage should be common to the CEV SM in order to build confidence in a single cryogenic engine that would return crews from the lunar surface. To make this engine available to support a 2011–2012 CEV SM would require a focused engine development program and require the system to be pressure-fed.

The EOR-direct return mission mode was eliminated from further consideration. In the direct return mode, the CEV must operate in, and transition among, 1-g pre-launch and post-landing, hyper-g launch, zero-g orbital and cruise, powered planetary landing and ascent, and 1/6-g lunar surface environments. This added significantly more complexity to a vehicle that must already perform a diverse set of functions in a diverse number of acceleration environments. Additionally, commonality of the SM between lunar and ISS configurations is further reduced in this case. The direct return lunar SM provides lunar ascent and TEI delta-V in excess of 2,400 m/sec, the LOR SM is of the order of 1,850 m/sec, and the ISS mission requires only 330 m/sec. The direct return CEV also requires no docking mechanism since the CEV is the lone crew cabin for the round-trip mission. Conversely, this reduced the commonality from the ISS to the lunar CEV. Ultimately, the ESAS team concluded that the direct return mode entails the greatest number of operability issues and uncertainties, most notably to the configuration of the CEV, and that the complexities of a CEV designed for a surface-direct mission will increase the cost and schedule risks for delivering an ISS-compatible vehicle in the 2011–2012 time frame. The study team eliminated direct return on the basis of CEV complexity, poor margins, greatest number of operability issues and uncertainties, and highest sensitivity to mass growth.

Analysis Cycle 2 began a focus on supplemental radiation protection that was to continue into the final analysis cycle. Radiation shielding was viewed as a risk reduction tool on par with other mission risks, and, based on the statistical modeling presented in this cycle, the decision was made to narrow the range of supplemental radiation protection to 2.0 g.cm² or less. The ESAS team also chose to modify the construction of the CEV based on the recommendation of the radiation analysis community. Based on the data presented in this analysis cycle, the skin of the CEV was changed from aluminum to carbon composite due to the superior radiation shielding properties of composites. For follow-on analysis, the ESAS team defined a probable cross-section of the CEV to be used for radiation transport calculations.

Cost, risk, and performance values were calculated for each of the three mission modes, with sensitivities calculated for decreasing supplemental radiation shielding and increasing propulsion efficiency. Direct return missions exhibit the lowest development costs, as well as the lowest P(LOM), but were eliminated from consideration for reasons of operational complexity. All mission modes were within a narrow range for P(LOM) (5.6 to 7.2 percent). The EOR–LOR mission mode showed the lowest P(LOC), and all modes and options were within a low range of 1.3 to 2.2 percent. The EOR–LOR mode has the highest mass margins, with the 2-launch EOR–LOR option having greater margins than the 1.5-launch EOR–LOR option. This 2-launch option closed only when supplemental radiation protection was eliminated and advanced propulsion was enabled for all LSAM stages. The EOR–LOR 1.5-launch option was distinctive in that it required the CEV to be qualified for only one LV (one with an extremely high crew safety) and would retain that CLV for future LEO operations.

Based on the outcome of Analysis Cycle 2, the team selected a focused set of Cycle 3 studies. Of particular interest were studies that could better define the viability of the 1.5-launch EOR–LOR mission mode option. Additionally, the performance of the LOR and EOR–LOR 2-launch solutions would be refined, and updated cost, safety, and reliability FOMs would be generated. Radiation analysis with 0–2 g/cm² shielding with an actual CEV cross-section and actual mission durations would be performed to better understand how radiation compared to other hazards to the crew. Global access to any site on the lunar surface and “anytime return” to Earth would be studied as a function of the required LOI and TEI delta-V, respectively, and this propulsive requirement would be incorporated into new propulsion system sizing. Refined CEV configurations and mass estimates would be joined with the updated propulsion sizing, the updated LV sizing, and updated EDS performance calculations to produce a clear picture of spacecraft and LV margins. By the conclusion of Cycle 3, the team was confident that the performance, cost, safety, and reliability analyses would converge so that a lunar mission mode could be recommended.

Finally, Analysis Cycle 3 would continue to investigate lunar lander and lunar surface configurations, with a focus toward investigating alternative LSAM configurations and outpost buildup concepts that could enable sortie-class missions to begin to emplace elements of the permanent outpost infrastructure as part of its cargo. This would challenge the team to analyze split-volume LSAM crew cabins, LSAM cargo packaging, and alternative surface airlock configurations.

4.2.5 Analysis Cycle 3 Mission Mode Analysis

The final cycle of design was focused toward the recommendation of a lunar mission mode. Analysis Cycle 3 continued a number of the Cycle 2 trade studies and undertook additional mission mode analyses emphasizing the EOR–LOR 2-launch, EOR–LOR 1.5-launch, and LOR mission architectures. To better define the performance of the lunar transportation system, the CEV configuration would need to be updated by assessing the sensitivity to supplemental radiation shielding of up to 2 g/cm². Additionally, the delta-V requirements for the LSAM descent stage and CEV SM were reevaluated to study the overall performance sensitivities to the requirements of global lunar access and “anytime return.” The revised vehicle masses would then be compared to updated LV and EDS designs to assess performance of the different mission modes and evaluate the use of excess performance margins. Each of the updated configurations would then be evaluated to determine differences in cost, P(LOC), P(LOM), and other FOMs to support the final lunar mission mode selection.

During the conduct of the previous analysis cycle, LCCs were calculated for each of the mission mode and technology options. This cost analysis, which is detailed in **Section 12, Cost**, was performed assuming an initial combination of sortie missions to a variety of sites and uncrewed cargo missions to construct an outpost, followed by regular crew and cargo missions to maintain a lunar outpost. This particular series of missions was based on an initial balance between sortie missions targeted for short-duration missions at specific sites of scientific interest and the desire for a permanent outpost. Many other implementations of the surface missions are possible, as discussed in **Section 4.3.5, Sortie Surface Traffic Model**. This initial approach of sortie-transitioning-to-outpost provided useful data on the relative costs of a sortie-based surface mission architecture versus an architecture that immediately builds up an outpost infrastructure that will support a continued presence of crews. This early cost exercise taught the team that an outpost emplaced in large, monolithic payload blocks could significantly exceed the available budget profile in some years. This was due to a combination of cargo lander development, cargo missions, and the development of the large cargo elements themselves (habitats, nuclear power systems, and science and resource utilization experiments) that would all need to occur simultaneously. Since other options exist to deploy the outpost with and without the use of large cargo landers, studies of alternative buildup concepts were undertaken in this cycle of the study. One such method is to utilize any available excess landed capacity on the crew lander and deploy the outpost in smaller, incremental pieces.

As part of the study of alternative outpost buildup concepts, the alternate configurations of the crew lander were included in the trade space. In addition to excess landed cargo capacity, the cabin of the lander itself offered an opportunity to make use of pressurized volume on the surface that would no longer be used by the crew after departure. This study of alternate lander configurations would begin with the requirements for pressurized crew volume for the 7-day surface stay and the operational need for an airlock, and then investigate how these capabilities could be divided into two areas: (1) those capabilities required for the crew to return to the CEV in lunar orbit and (2) those that could remain on the surface and contribute to the surface infrastructure or be scavenged for resources.

4.2.5.1 Trade Studies

Three major trade studies were undertaken during Analysis Cycle 3 to narrow the mass uncertainty of the CEV and explore alternatives for the deployment of lunar surface outposts. The radiation analysis study begun in Analysis Cycle 2 was updated using a more detailed CEV cross-section and improved analysis tools. Global access and anytime return were studied in detail to understand the sensitivities of delta-V and loiter time. The configuration of the lunar lander was revised to explore packaging of habitable volumes and options for lunar outpost deployment.

4.2.5.1.1 Radiation Study

The Analysis Cycle 3 radiation study focused more heavily on creating the best approximation to the actual CEV in order to generate a more refined and realistic radiation evaluation. The radiation protection and resultant dose/risk associated with the analysis of an analytical CEV model depends highly on how accurately that model reflects the actual design. This higher-fidelity model included the addition of a TPS, composite Outer Mold Line (OML) skin, and insulation to the structure of the vehicle (in addition to the original HDPE radiation shield and aluminum hull). The inclusion of these structures had a significant impact on the amount of radiation shielding the vehicle inherently provided. For comparison purposes, the shield distribution was generated in the same fashion and using the same points as the Analysis Cycle 2 evaluation. Calculations for the historical large SPEs were repeated with the refined CEV configuration and the values of thin HDPE (1 or 2 g/cm²) augmentations. Results are shown in **Table 4-16**.

Table 4-16. CEV Radiation Shielding Acute and Late Risks for Largest Fluence SPE

Aluminum Vehicle, 4x 1972 SPE			
HDPE Depth (g/cm ²)	% Acute Death*	% Sickness	% REID**
CEV-old + 0 g/cm ²	9.5	54	9.1 [3.2,17.3]
CEV-new + 0 g/cm ²	<1% (***)	<5% (***)	4.4 [1.5, 11.8]
CEV-new + 1 g/cm ²	0	0	3.5 [1.2, 9.7]
CEV-new + 2 g/cm ²	0	0	2.9 [1.0, 8.2]

*Death at 60-days with minimal medical treatment

**Risk of Cancer death for 45-yr-old females

***Too close to threshold to estimate

The probability of acute risk is difficult to estimate accurately for the baseline revised CEV configuration because of lack of radiobiological data at the 0–10 percent probability levels and the potential impacts of immune depression and stress on the dose-response. The addition of HDPE would likely prevent the occurrence of acute risks from a historically large SPE. A statistical analysis of the uncertainties in the acute projections will be needed to properly perform the analysis.

As shown in **Table 4-17**, fatal cancer risk limits or the 95 percent confidence limit requirements would be exceeded for most astronauts with no prior occupational exposure below age 45-yr for the revised CEV with 0 or 1 g/cm² polyethylene augmentation shielding. For astronauts with prior ISS exposure, larger constraints will occur. With the 2 g/cm² HDPE augmentations, 95 percent confidence limits would be exceeded for a significant fraction of the astronaut population. Higher constraints are possible if fatal non-cancer risks are added to the NASA legal dose limits.

Risk of Exposure Induced Death for 45-yr Females					
Nx1972	Probability (worst-case SPE)	CEV-old with 0 g/cm ² HDPE	CEV-new with 0 g/cm ² HDPE	CEV-new with 1 g/cm ² HDPE	CEV-new with 2 g/cm ² HDPE
4x	99.1	9.1 [3.2, 17.3]	4.4 [1.5, 11.8]	3.5 [1.2, 9.7]	2.9 [1.0, 8.2]
3x	98.5	6.9 [2.4, 16.0]	3.3 [1.1, 9.2]	2.6 [0.9, 7.4]	2.2 [0.7, 6.2]
2x	97.0	4.7 [1.6, 12.5]	2.2 [0.8, 6.3]	1.7 [0.6, 5.0]	1.5 [0.5, 4.2]
1x	93.0	2.4 [0.8, 6.7]	1.1 [0.3, 3.2]	0.9 [0.3, 2.5]	0.7 [0.2, 2.1]

Table 4-17. Risk of Fatal Cancer for Large SPEs

Risk Leveling

As introduced in **Section 4.2.4, Design Cycle 2 Mission Mode Analysis**, the ESAS team adopted a policy of “risk leveling” in order to protect astronaut crews equally from all known sources of injury or death. When applied to radiation dose and effects, the team viewed this risk as having both an acute, short-term effect that could result in LOM and LOC and a long-term effect of excess cancer risk due to exceeding monthly or career dose limits. Acute sickness was conservatively judged to incapacitate the crew to the extent that they could not perform any of their functions, which would lead to LOM and LOC due to their inability to act. The team sought to arrive at a solution that produced near-zero percent probability of acute death or sickness and that did not violate 30-day or career limits for an event with a probability of occurrence equal to that of other LOC risks for a sortie-duration lunar mission. For longer-duration lunar outpost missions, this analysis would be repeated to determine the proper amount of surface habitat shielding required to achieve this same level of protection.

In order to establish the probability of an SPE occurrence that would exceed a fluence of 30 MeV, a 9-day mission duration was chosen as the average length of time a crew would inhabit the CEV during a sortie-class lunar mission. For longer mission durations, these numbers would increase. **Table 4-18** relates the probability of occurrence of a 30 MeV SPE to the biological effects (acute effects and long-term dose) for 0, 1 and 2 g/cm² of supplemental HDPE shielding for a 9-day CEV mission. At 2 g/cm², all acute effects are zero and long-term doses are within limits until events with a probability of occurrence of 1 in 2,500 (0.04 percent) missions are encountered. With 1 g/cm² of shielding, acute effects are again all zero, but 30-day limits are violated once in every 1,428 (0.07 percent) missions. With all supplemental shielding removed, acute health effects begin to appear once in every 1,428 (0.07 percent) missions, while 30-day limits are violated once in every 588 (0.17 percent) missions.

Table 4-18. SPE Risks to Crew (Acute and Long-term Dose) as a Function of Supplemental Shielding for a 9-Day CEV Mission

CEV with 0 g/cm ² HDPE						
Nx1972 Event	F(>30 MeV)	% Probability for 9-Day mission	Acute Death	Acute Sickness	Career Limit Violation	30-Day Limit Violation
4x	2x10 ¹⁰	0.02	<1%	<5%	Yes	Yes
3x	1.5x10 ¹⁰	0.04	0	<1%	Yes	Yes
2x	1x10 ¹⁰	0.07	0	0	No (95% Yes)	Yes
1x	5x10 ⁹	0.17	0	0	No (95% Yes)	No
1% Event	1.5x10 ⁹	1.00	0	0	No (95% Yes)	No
CEV with 1 g/cm ² HDPE						
Nx1972 Event	F(>30 MeV)	% Probability for 9-Day mission	Acute Death	Acute Sickness	Career Limit Violation	30-Day Limit Violation
4x	2x10 ¹⁰	0.02	0	0	Yes	Yes
3x	1.5x10 ¹⁰	0.04	0	0	No (95% Yes)	Yes
2x	1x10 ¹⁰	0.07	0	0	No (95% Yes)	Yes
1x	5x10 ⁹	0.17	0	0	No	No
1% Event	1.5x10 ⁹	1.00	0	0	No	No
CEV with 2 g/cm ² HDPE						
Nx1972 Event	F(>30 MeV)	% Probability for 9-Day mission	Acute Death	Acute Sickness	Career Limit Violation	30-Day Limit Violation
4x	2x10 ¹⁰	0.02	<1%	<5%	Yes	Yes
3x	1.5x10 ¹⁰	0.04	0	<1%	Yes	Yes
2x	1x10 ¹⁰	0.07	0	0	No (95% Yes)	Yes
1x	5x10 ⁹	0.17	0	0	No	No
1% Event	1.5x10 ⁹	1.00	0	0	No	No

In the cases of acute death or sickness, radiation exposure has an effect equal to any other risk which results in LOC. For long-term dose violations, the effect may be an increased probability of lifetime cancer risk to the crew members, but, for the purpose of this analysis, it was conservatively considered to be an LOC risk as well. The complete lunar sortie mission risk analysis is presented in **Section 8, Risk and Reliability**, of this report. The analysis details many of the events that could result in LOC, many of which are large-energy change events such as launch, planetary injection or insertion maneuvers, or planetary landings. Other events are lifetime issues associated with vehicle systems. As a group, the individual risks that result in LOC occur in the 1:100 to 1:1,000 range (1.0 to 0.1 percent individual probability of occurrence). To level the probability of radiation risk, a solution was sought that placed the P(LOC) due to radiation within this range (and preferably nearer to 0.1 percent). The ESAS team used **Table 4-18** for the statistical probabilities generated by the radiation community. Per the table, the 1.0 percent probable event has no adverse biological effects for any level of shielding. Similarly, the 0.17 percent SPE has no acute or lifetime biological effect for any level of shielding, including a CEV with no supplemental shielding. It was not until the mission encountered the 0.07 percent probable SPE that the first of the Next Hop Resolution Protocol (NHRP) limits were exceeded.

The ESAS team therefore recommended that, for the modeled cross-section and material choices, no supplemental radiation protection was required for the CEV. With the inherent shielding properties of the CEV structure alone, all radiation effects, less one, show a lower probability of occurrence than equivalent LOC risks; additionally, the one with the greatest probability of occurrence falls within the low end of the range of equivalent LOC events. For the CEV without supplemental shielding, acute effects would occur less than once in every 1,428 missions (<0.07 percent), career dose limits would be exceeded less than once in every 1,428 missions (<0.07 percent), and 30-day dose limits would be exceeded less than once in every 588 missions (<0.17 percent).

Supplemental radiation shielding ultimately has an effect on the performance of the entire transportation system. Any mass associated with the CEV must travel round-trip from Earth to lunar orbit and back. Thus, the performance sensitivity is second only to mass that travels round-trip to the lunar surface. The performance effect of supplemental radiation shielding is shown in **Figure 4-30**. With a performance impact of almost 500 kg for every g/cm² of shielding added, the CEV design should seek to minimize supplemental radiation shielding. Additional configuration studies should continue to be performed to further reduce the dose to crews by optimizing the arrangement of crew, fuel, and stowage.

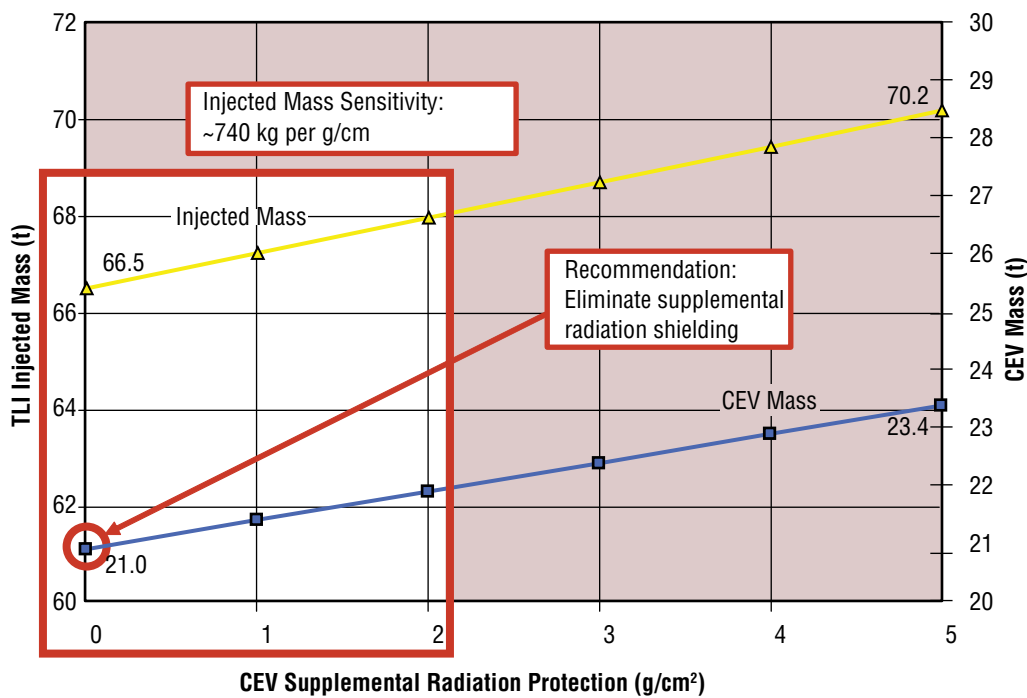
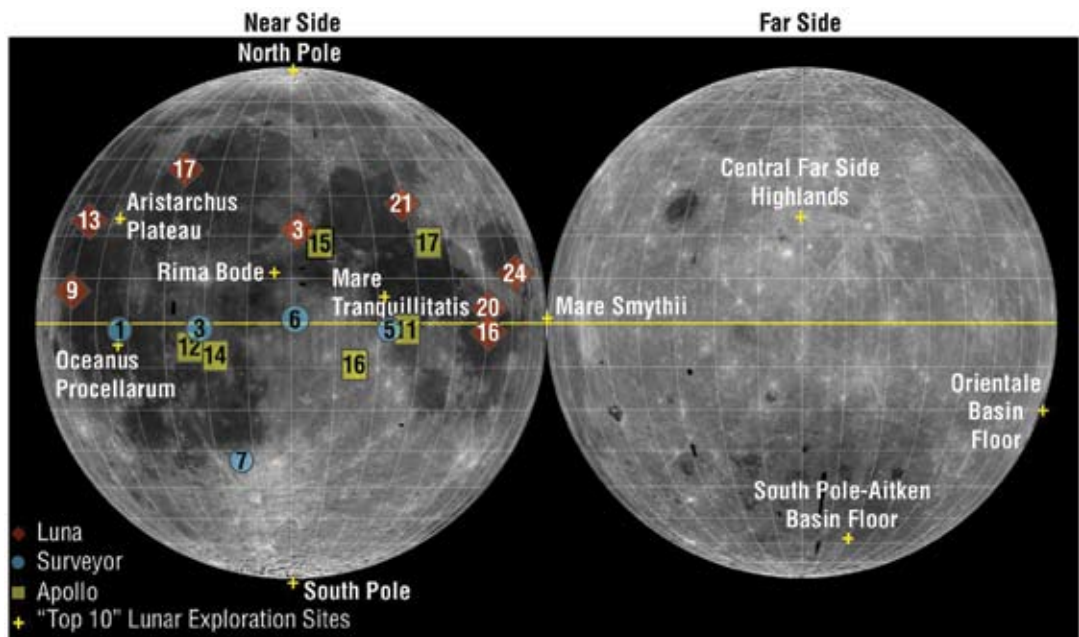

Figure 4-30. 1.5-launch EOR-LOR Sensitivity to CEV Radiation Protection

4.2.5.1.2 Global Access/“Anytime Return”

Another of the Analysis Cycle 3 trade studies was conducted to understand the architecture mass cost of global lunar surface access and “anytime return.” Global access was initially interpreted by the ESAS team as the ability of the architecture to conduct a 7-day sortie mission to any location on the lunar surface without requiring any dedicated loiter time in LLO prior to descent and being independent of Earth-Moon system geometry (e.g., for any inclination/declination of the Moon). “Anytime return” was interpreted as giving the crew the ability to return from the lunar surface to Earth independent of orbital plane alignment and within 5 days of an emergency return declaration. These conditions were satisfied in previous architecture design cycles by including sufficient delta-V for LOI and TEI to perform a worst case 90-deg plane change around the Moon.

The global access trade examined the LOI delta-V cost for 7-day sortie missions to various locations on the lunar surface. A list of 10 high-priority sites selected for their perceived scientific and resource utilization value were studied first, followed by a global delta-V map calculated in 10-deg increments of latitude and longitude. The same global map was then calculated assuming the crew could loiter in lunar orbit up to 3 days prior to descent to minimize the LOI plane change cost. The 10 sites are shown in **Figure 4-31**, and each is described in more detail in **Section 4.3, Lunar Surface Activities**.



The following assumptions were used for calculating global access delta-V costs:

- Only outbound portions of the mission were examined.
- The LOI maneuver is a three-impulse sequence to minimize plane change costs.
- The nominal transfer time from TLI to LOI (first maneuver of three-impulse sequence) is 4 days.
- The nominal time from the third maneuver of a three-impulse sequence to descent is 1 day for crew transfer and checkout.
- Earth departure conditions are (1) a LEO parking orbit altitude of 407 km circular, (2) an inclination of 28.7 deg, and (3) the LEO parking orbit ascending node is free and can be selected to minimize delta-V cost.
- A TLI delta-V limit of 3,150 m/s is imposed.
- The arrival epoch is 12/25/2034 to produce a worst-case lunar geometry at arrival. The Moon is at perigee, at its minimum inclination in the 18.6-year metonic cycle (18.3 deg), and at maximum declination (18.3 deg).
- The ascending node and inclination of the lunar parking orbit are selected such that the maximum plane change is minimized for anytime ascent over the 7-day mission.

LOI delta-Vs for 7-day sorties to the top 10 science/resource utilization sites are listed below in **Table 4-19**. The maximum delta-V is 1,078 m/s for a mission to the far side South Pole-Aitken Basin floor. Vehicle sizing for LOI in all design cycles has included 1,390 m/s to protect for a worst-case 90-deg plane change at arrival.

LOI Delta-V (m/s)			
Landing Site	Latitude	Longitude	Delta-V
South Pole	89.9 S	180 W	835
Far side SPA floor	54 S	162 W	1,078
Oriente basin floor	19 S	88 W	944
Oceanus Procellarum	3 S	43 W	841
Mare Smythii	2.5 N	86.5 E	826
W/NW Tranquilitatis	8 N	21 E	852
Rima Bode	13 N	3.9 W	851
Aristarchus plateau	26 N	49 W	881
Central far side highlands	26 N	178 E	925
North Pole	89.5 N	91 E	835

Table 4-19. LOI Delta-V for Top 10 Lunar Sites

Next, a global LOI map (as seen in **Figure 4-32**) was generated for 10-deg increments of landing site latitude and longitude, assuming no additional loiter time in LLO. The global minimum delta-V is 835 m/s for polar or near-equatorial sites, while local delta-V maxima are found near 75°N or S latitudes and 25°E/160°W longitudes. The global maximum delta-V is 1,313 m/s. However, a single mission design technique, described in the assumptions above, was uniformly applied to all possible landing sites. Thus, it may be possible to reduce the maximum LOI delta-V through mission design optimization.

Nominal Mission – LOI Delta-V
 Arrival Epoch: 12/25/2034 Extended Loiter Time = 0–0 days

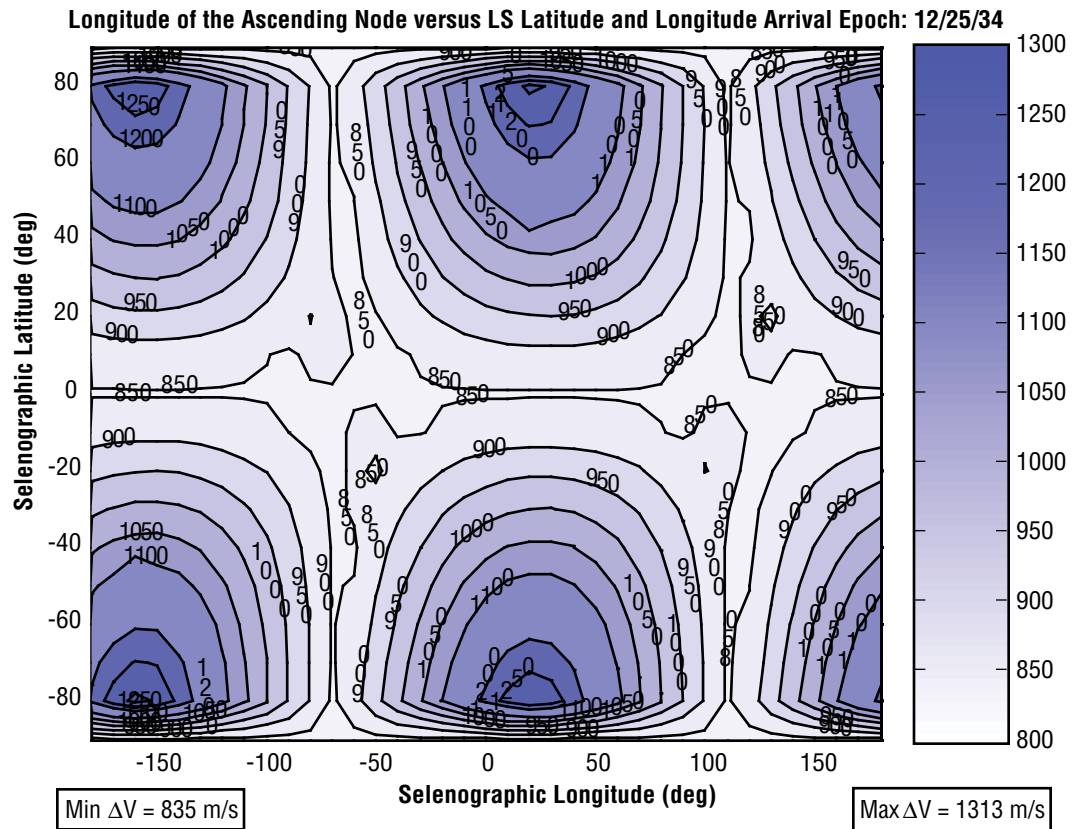

Figure 4-32. Global LOI Delta-V Map, No Loiter Time

Finally, the same global LOI contour map was generated allowing the crew to loiter up to 3 days in LLO to reduce the plane change delta-V cost. The lunar parking orbit ascending node is selected such that, up to 3 days after arrival, the landing site passes underneath the parking orbit plane. This mission design flexibility allows the ascending node change during LOI to be minimized. The net reduction in maximum LOI delta-V is 212 m/s, from 1,313 m/s with no loiter time to 1,101 m/s with up to 3 days loiter time. The LOI map with 3 days of loiter time is provided in **Figure 4-33**.

Nominal Mission – LOI Delta-V

Arrival Epoch: 12/25/2034 Extended Loiter Time = 0–3.0 days

Longitude of the Ascending Node versus LS Latitude and Longitude Arrival Epoch: 12/25/34

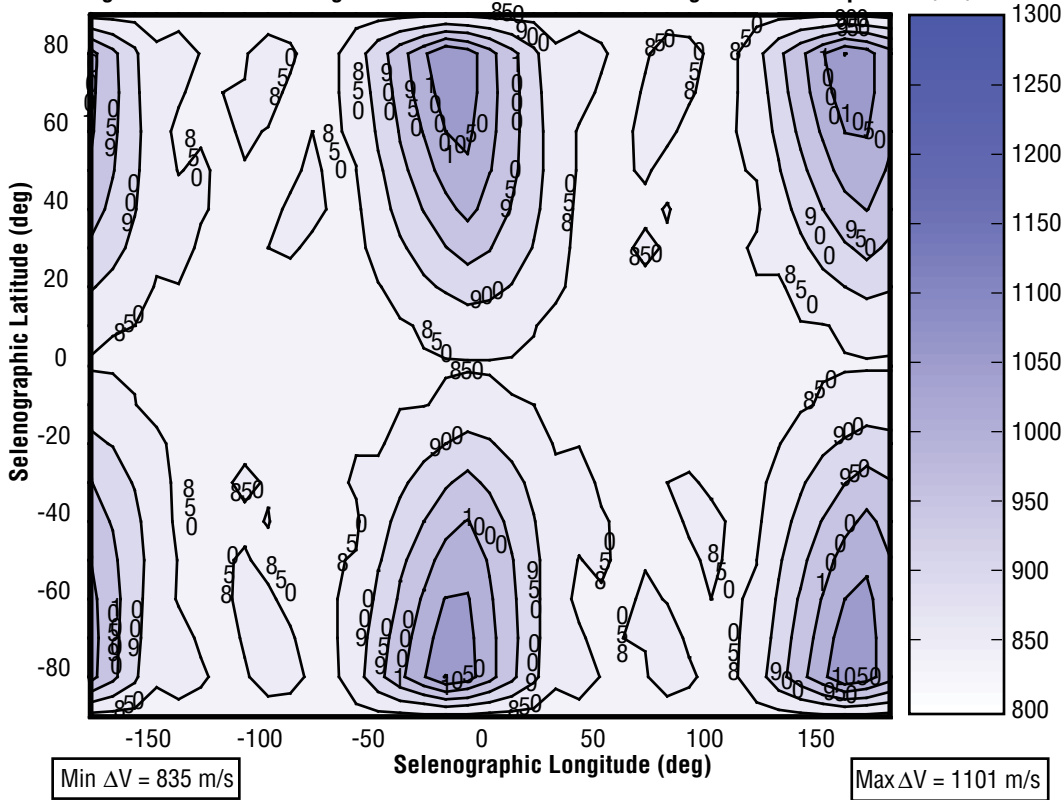

Figure 4-33. Global LOI Delta-V Map, 3-Day Loiter Time

The second part of the global access/“anytime return” trade examined the mass cost of including the capability for the crew to return from lunar orbit to Earth, independent of orbital plane alignment. This capability was manifested as a 90-deg plane change included as part of the TEI maneuvers. To save architecture mass, the CEV and crew could instead loiter in LLO until a more favorable departure opportunity arose. In a worst-case scenario, assuming the first coplanar TEI opportunity was just missed, the crew would have to loiter up to 14 days until the next coplanar opportunity became available. **Figure 4-34** illustrates how CEV total mass, propellant mass, and crew provisions mass each varies as a function of loiter time in LLO (and therefore maximum plane change capability). The CEV “anytime return” capability assumed for architecture sizing purposes is shown on the left side of the figure. Since the crew does not have to loiter at all to return to Earth, the vehicle includes up to a 90-deg plane change for TEI. The maximum CEV injected mass in that case is 22.0 tons (t), while propellant and crew/crew provisions account for 11.8 t and 1.2 t, respectively. The right side of the figure shows the scenario where the CEV is allowed to loiter in lunar orbit until a coplanar TEI opportunity arises, which may last up to 14 days, but eliminates the plane change requirement. Loitering reduces the CEV injected mass to 19.4 t and the propellant mass to 6.3 t, while the crew/crew provisions mass increases to 1.6 t. Because the propellant mass decreases with loiter time faster than crew provisions mass increases, the CEV sees an overall net mass reduction. Injected mass decreases 185 kg per day of loiter in lunar orbit. **Section 4.2.5.2, Analysis Cycle 3 Performance**, of this report will further discuss the interaction of TEI and LOI delta-V as it relates to overall mission performance.

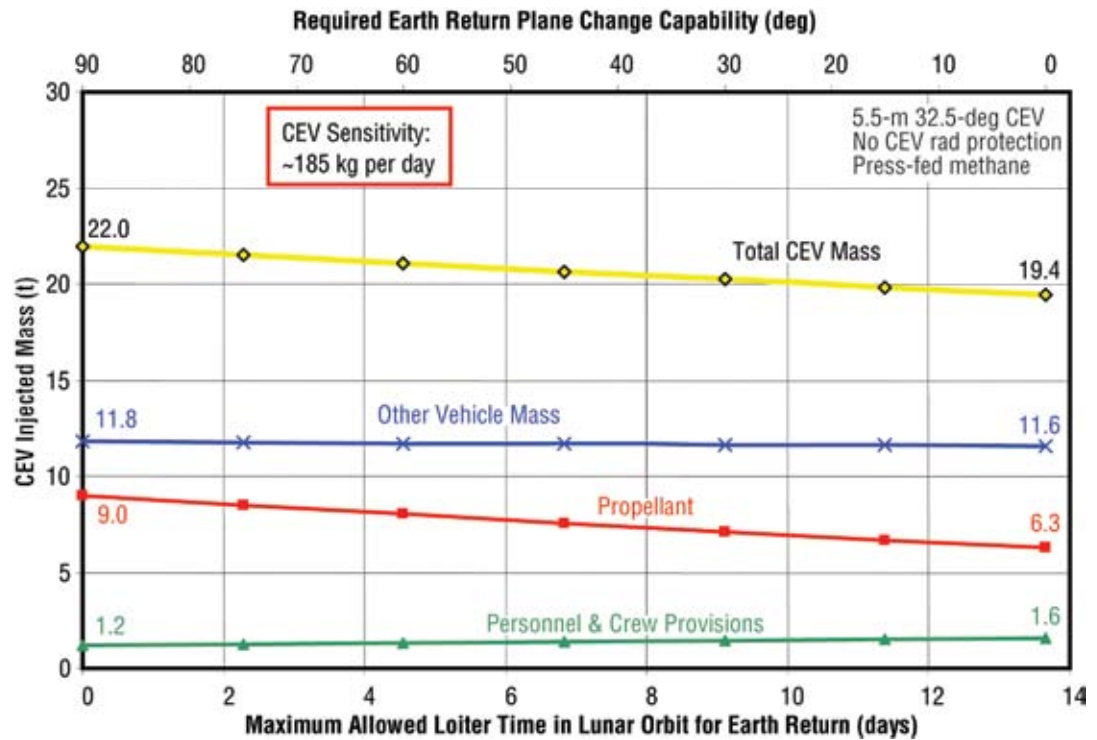

Figure 4-34. CEV Anytime Return Performance

The final part of the trade involved assessing the “cost” of implementing global access and “anytime return.” For LOR missions, the propulsive (or mass) “cost” is affected by adding propulsive maneuvers and fixing surface sorties at 7 days. For a fixed TLI of 3,150 m/sec, a maximum three-impulse LOI of 1,390 m/sec is required to achieve global access, which includes a worst-case nodal plane change of up to 90 deg. Departure is from a 407-km circular LEO parking orbit at 28.7 deg inclination. Earth departure Right Ascension of Ascending Node (RAAN) is free and can be adjusted to minimize delta-V cost. The LOI maneuver would set up a “node walking” orbit that would position the CEV for a coplanar LSAM ascent in 7 days. Lunar orbit arrival inclination and Longitude of Ascending Node (LAN) are specified for each landing site latitude and longitude and are based on the minimum departure wedge angle requirement. One day of loiter is assumed in LLO before LSAM landing for LSAM checkout. If the LSAM were to depart the surface early, the CEV would also be given the capability to perform up to a 5-deg nodal and inclination plane change to set up for LSAM rendezvous—a maneuver of 150 m/sec. Finally, anticipating that the CEV may be up to 90 deg out of plane for the return trip to Earth, a 550 m/sec, three-burn nodal plane change was included in addition to the nominal TEI delta-V. The combination of these maneuvers provides all of the required global access and “anytime return” capability, but at the expense of a great deal of excess propulsive capability and additional mass.

The magnitude of these propulsive maneuvers can be decreased through any combination of adjusting the total time spent on the lunar surface, adjusting time spent in post-LOI loiter (prior to lunar descent), and adjusting the time spent in past-ascent loiter prior to TEI. The 7-day surface mission was held constant to preserve surface mission content, and the full nodal plane change at TEI was retained to preserve “anytime return.”

To implement “global access,” the LOI delta-V was traded against post-LOI loiter time. When loiter time is added to the trade space, the “cost” of global access becomes a function of both LOI delta-V and risk. LOI delta-V as a function of lunar landing site latitude and longitude is shown in **Figure 4-32** and similar delta-V maps were run for pre-descent loiter durations of 0.5 to 7.0 days, in 0.5-day increments. Generally, the maximum LOI delta-V decreases as orbital loiter time increases from zero to 7 days. With a 7-day loiter, LOI reaches a coplanar minimum of 868 m/sec.

Just as the total system mass decreases with additional LLO loiter time, risk increases as a function of increased mission duration. P(LOM) and P(LOC) both increase with loiter time. Due mainly to extended operational timelines of the CEV in lunar orbit, P(LOM) increases at 0.205 percent per day and P(LOC) increases at 0.135 percent per day. **Figure 4-35** illustrates the change of the P(LOC) and P(LOM) for CEV and LSAM vehicle systems for extending orbital loiter prior to lunar descent. LV and propulsion risk probabilities are not included in this figure because they remain constant with respect to loiter time.

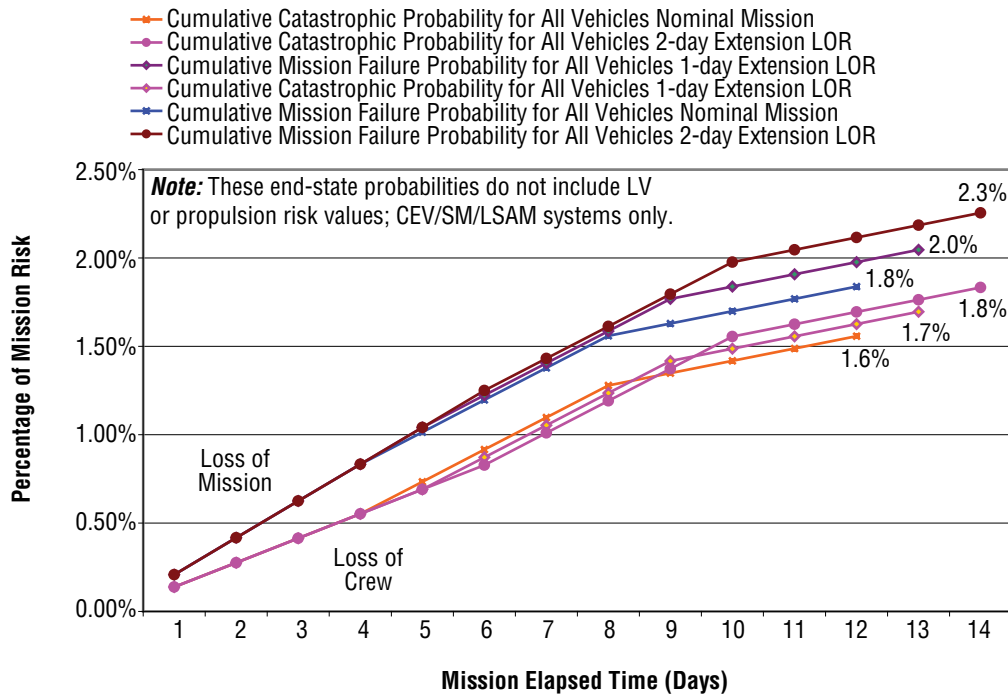

Figure 4-35. Delta P(LOC) and P(LOM) for Extending Orbital Loiter Prior to Lunar Descent

The ESAS team ultimately chose to increase the IMLEO and lander mass margin and to decrease descent stage sizing by requiring the system to accommodate up to a 3-day pre-descent loiter. With this maximum loiter duration, global access can be attained for an LOI delta-V maximum of 1,101 m/sec, as shown previously in **Figure 4-33**. The system would have the capability for immediate access to 84 percent of the lunar surface without additional orbital loiter and could access the remaining surface area by adding no more than 3 days post-LOI orbital loiter. For a maximum 3-day additional loiter, the P(LOC) will incrementally increase 0.4 percent and the P(LOM) will increase 0.6 percent.

4.2.5.1.3 LSAM Configuration Trades

The LSAM configuration trade study was initiated during Analysis Cycle 3 in order to develop a better understanding of the overall system performance and capabilities necessary for the lunar landing portion of the mission. The intent of this study was to develop a higher-fidelity conceptual lander design with special emphasis placed on the numerous competing needs driving the overall vehicle configuration. Focus on LOR mission modes allowed for further optimization of the LSAM configuration, thus providing a better understanding of the relative benefits of differing lunar vicinity segment mission approaches, as well as to determine mission sensitivities to key system design parameters.

The LSAM vehicle provides the key functional capabilities necessary for both the lunar sortie and lunar outpost mission phases. The LSAM must function in a wide range of mission modes, which makes optimization and vehicle configuration development extremely challenging. For instance, surface durations range from 7 active/0 dormant days in the sortie mission phase to 4 active/180 dormant days in the lunar outpost phase. Likewise, in order to reduce the overall development cost and schedule, it is desired to have a common descent stage design for both crew and uncrewed cargo mission modes and commonality of propulsion systems between the LSAM and CEV SM.

Key Functional Requirements and GR&As

The following key functional requirements and GR&As were used for the study, with emphasis placed on ensuring that the architecture approach was consistent with the Cycle 3 ESAS architecture and mission assumptions.

- Mission Mode: Utilize LOR mission approach. In that context, the LSAM may be utilized to perform the LOI maneuver, deorbit, powered descent, hazard avoidance, terminal landing, ascent, and rendezvous. The CEV remains in LLO, which is assumed to be 100 km circular; inclination is landing site dependent.
- Airlocks: All crew landers have airlocks to enable routine exploration of the lunar surface.
- Hardware Reuse: Emphasize leaving hardware behind that can be used for outpost buildup.
- Crew Size: Assume four crew, with all crew traveling to the surface for the entire surface mission duration.
- Surface Duration: Assume up to 7-day sortie missions and up to 180 days during outpost missions.
- LV Shroud: Shroud sizes range from 7.5–10 m. Focus on 8.5 m.
- Commonality: Emphasize a common crew/cargo descent stage concept.
- ISRU: Capable of utilizing locally produced propellants.
- Descent Propellant Type: Utilize hydrogen and oxygen as the propellants for the descent phase of the lunar mission. Hydrogen and oxygen were selected as a technology implementation necessary to reduce the overall mission mass to within reasonable limits.

Review of Previous Lander Design Work

The LSAM design study was initiated with a quick review of the various lunar architecture and mission studies conducted over the past several years, with special emphasis specifically placed on the lander designs. This survey provided a range of vehicle concepts and resulting mission performance as driven by the architecture approach and associated mission requirements. The applicability of each of these studies was considered in terms of the driving mission requirements utilized during that particular study as they applied to the ESAS activity. A review of these previous studies showed that the 2005 ESMD LSAM Phase I study had a high degree of applicability to the current ESAS and was thus utilized as the primary starting point for the LSAM configuration analysis.

During the early spring of 2005, the ESMD initiated a study of the LSAM as it applied to the current ESMD POD Architecture. The purpose of this task was to conduct a wide range of configuration trades in order to understand the architectural sensitivities and constraints (e.g., launch mass and volume, crew and cargo delivery, crew and cargo unloading, etc.). Results from this study were used to initiate formulation of architecture and element requirements. The study focused on investigating a wide range of vehicle concepts in order to understand the key driving characteristics as they apply to the exploration architecture. Vehicle concepts were studied at a high level in order to drive out the key discriminators to allow further downselection to a limited number of vehicle concepts for further detailed sensitivity and trade study.

LSAM Configuration Considerations

Several different vehicle configurations were investigated in order to span the breadth of configuration options. Combinations of staging approaches, vehicle CM division, and options for leaving vehicle components on the lunar surface for future use were included in the study. The five key configurations utilized for downselection are provided in **Figure 4-36**. Both vertical and horizontal vehicle configurations were considered, as well as both single and dual CMs.

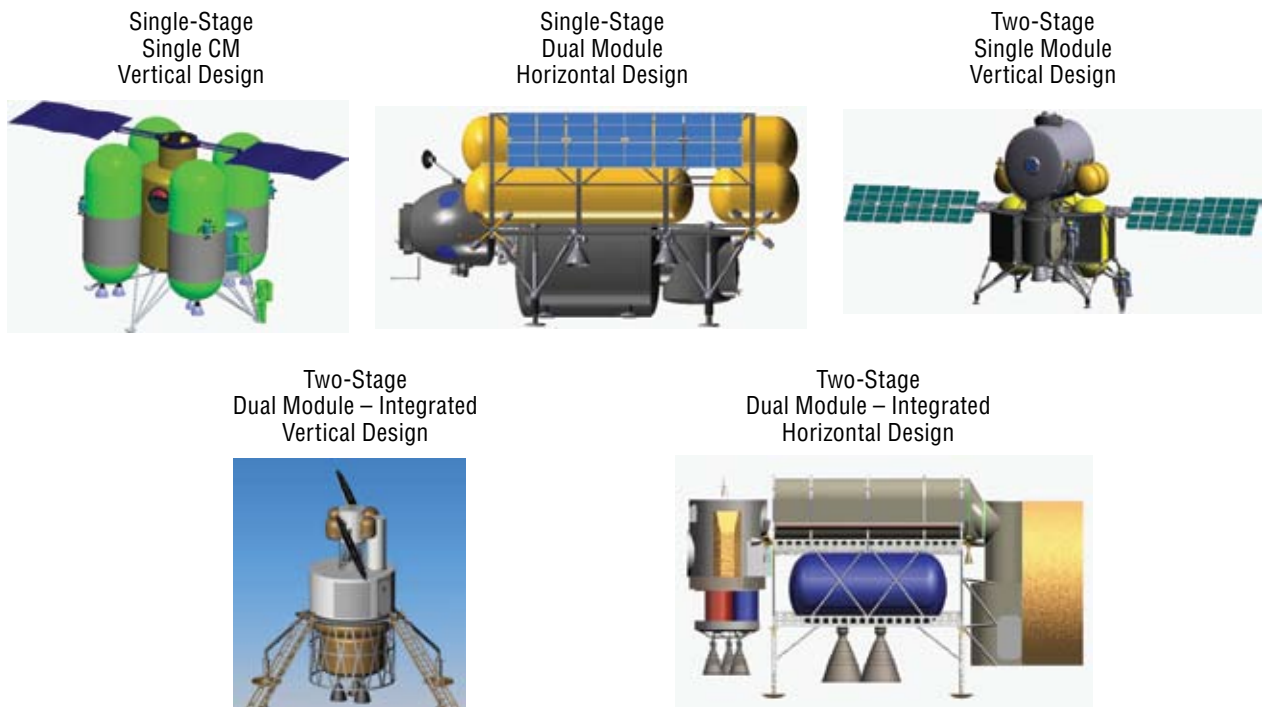

Figure 4-36. Initial LSAM Configurations

LSAM Configuration Selected for Further Assessment

Key FOMs were established to provide guidance for configuration selection. A survey of FOMs utilized for previous exploration architecture and vehicle design studies was performed, and the results were synthesized to drive out those qualities that would provide greater insight into the LSAM design and operational features. The FOMs used for further configuration downselection are provided in **Table 4-20**. The study team utilized a weighted scoring approach to better understand the relative benefits of the various configurations as they specifically apply to the FOMs. The two-stage vertical configurations were selected as the departure points for the ESAS Analysis Cycle 3, since they provided the best configuration for satisfying the identified FOMs.

Table 4-20. Key LSAM FOMs

Key LSAM Figures of Merit	
Overall Mission Performance	Operations and Risk
<ul style="list-style-type: none"> • Shroud diameter • Launch mass • Complexity of launch vehicle attachment • Center of Gravity (CG) offset during launch • Engine-out during landing 	<ul style="list-style-type: none"> • Crew access to surface • Landing stability • Flight controllability • Engine restarts • Surface debris hazards on landing • Complexity of ascent separation
Outpost Mission Support	Development Cost and Schedule
<ul style="list-style-type: none"> • Cargo unloading complexity • Leaving behind useful assets • Payload delivery with the crew • Capability of using local propellants (ISRU) • Crew/cargo descent stage commonality 	<ul style="list-style-type: none"> • Complexity of design and manufacturing • Technology development cost • System commonality with the CEV

Driving Considerations

During the LSAM configuration study, several key driving considerations were identified as key elements impacting the overall vehicle performance. These key driving considerations were very interrelated and required in-depth consideration during the analysis.

Surface Access for Crew and Cargo

Providing the ability for the crew to routinely access the lunar surface is a key discriminator in the overall vehicle configuration selection. Concepts that increase the distance that the crew must traverse from their living quarters to the surface increase overall crew fatigue as well as probability of potential crew injury. Likewise, payload unloading must be considered, especially during the sortie and early outpost missions, when little or no lunar surface support is available. Providing configurations with an airlock integrated within the CM or an airlock split from the CM on another level of the LSAM were considered. This single versus split configuration is depicted in **Figure 4-37**.

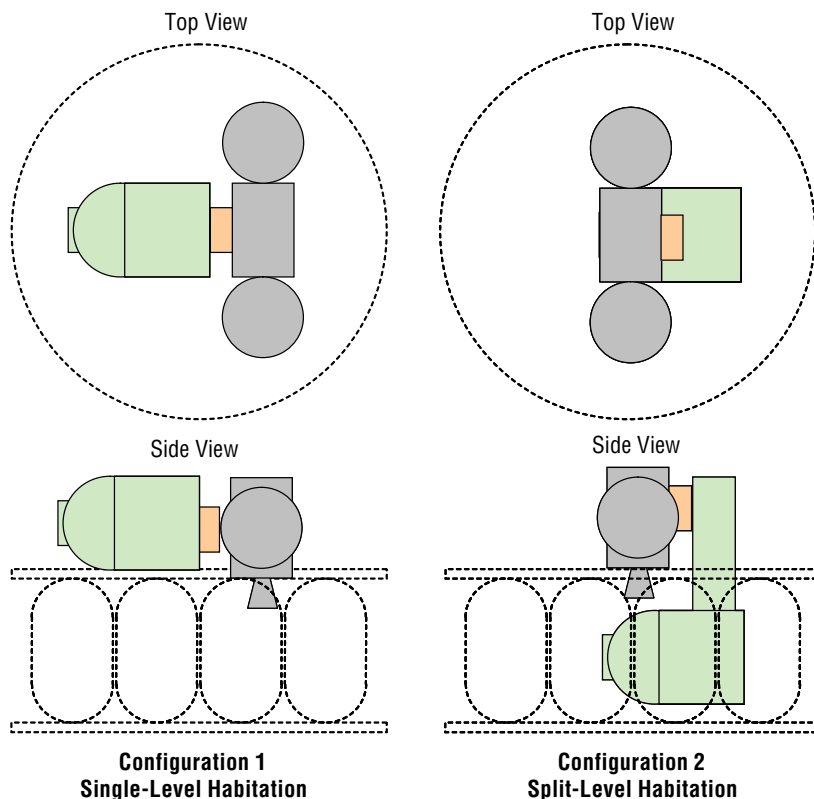

Figure 4-37. Single versus Split Level Habitation Concepts

The single-level habitation module configuration provides quick and easy access of the crew to the ascent stage for both nominal and emergency ascent conditions. In addition, this configuration leaves a cargo bay open on the lower level for payload while keeping an area available on the upper platform as well. Because the CM, including the airlock, is located on the upper level, all EVAs begin at a greater height above the surface.

Because the airlock is located on the lower level, the split-level habitation configuration provides easier crew access to the surface. In addition, the living space is well-protected from radiation because it is integrated among the propellant tanks. Unlike the single-level configuration, the living space on the lower level takes up most of the potential payload cargo space.

Propellant Volume and Tank Configuration

Due to the high propulsive performance required by the vehicle, propellant selection is a key aspect of the overall LSAM configuration. A balance must be found between the performance required and configuration layout of the vehicle. For instance, propellants that provide moderate performance (i.e., hypergolics) package more efficiently than higher-performing propellants (i.e., hydrogen/oxygen), but at the expense of overall increased mission mass. Cycle 2 ESAS analysis (**Section 4.2.4.1, Trade Studies**) indicated that higher-performing propellants were necessary to provide the overall mass efficiency for the architecture. This necessitated the use of higher-performing hydrogen and oxygen in the lunar descent leg of the mission. Unfortunately, hydrogen is a very voluminous fuel, requiring large tanks to store. This in turn complicates the overall vehicle packaging and increases the deck height of the landed vehicle.

Likewise, the LV shroud size (namely diameter) has a profound impact on the LSAM overall packaging efficiency and design as shown in **Figure 4-38**. As can be seen in this figure, the LSAM tank layout and descent stage deck height are directly driven by the shroud diameter. As the diameter is reduced, as is shown in the 7-m configuration, deck height is significantly increased and tank packaging becomes complicated. As the diameter is increased, as is shown in the 10-m configuration, deck height is decreased and additional space can be provided for engine intrusions as well as payload capacity.

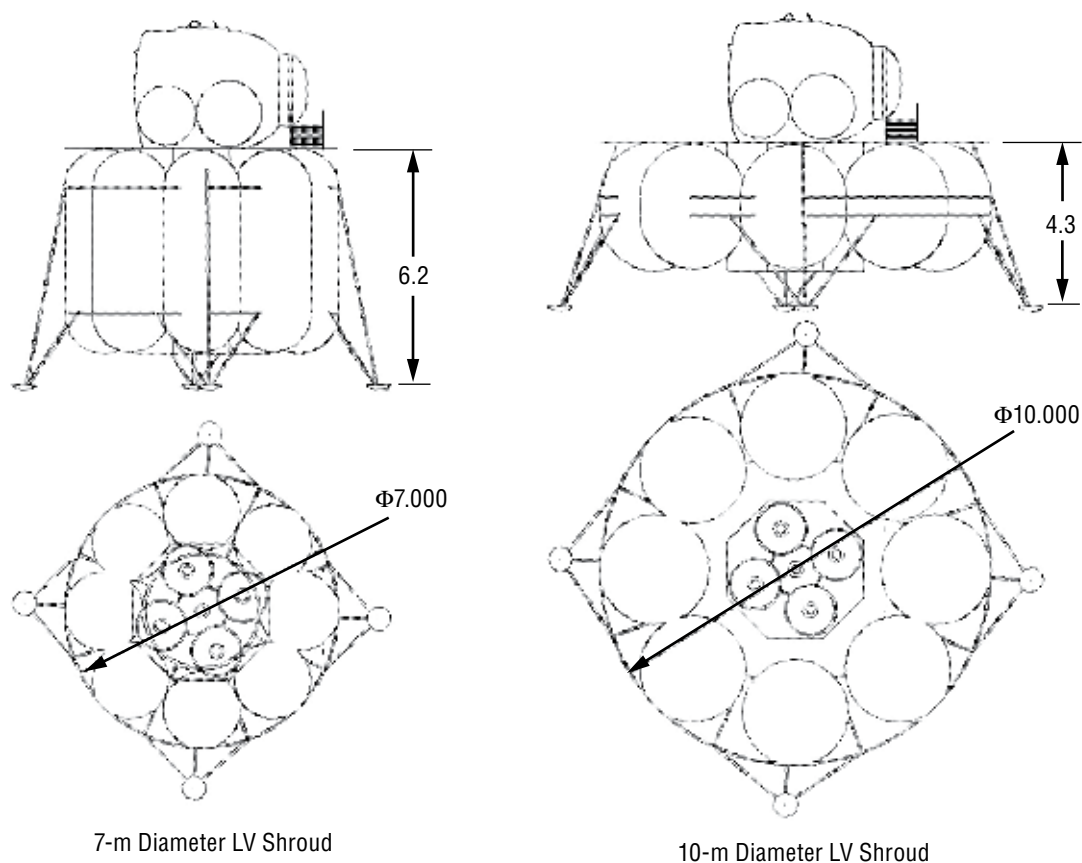

Figure 4-38. LV Shroud Diameter Influence on LSAM Tank Configuration

Common Crew/Cargo Design

One of the overarching guidelines for the study was to investigate a common descent stage design for both crew and cargo missions. Crew safety during ascent necessitates a separation system for the ascent and descent stages that can operate with a high degree of reliability. In addition, the surface strategy studies indicated the need for the delivery of a few large integrated payloads (i.e., surface habitat, pressurized rovers, and nuclear power systems). These payloads require large, unobstructed payload space, combined with the need to be as low as possible to the lunar surface for potential future unloading.

LSAM Crew Cabin Configuration Layout Trades

Several different configuration trades were conducted to determine the impact of varying degrees of segmentation of the living capabilities of the combined descent stage, ascent stage, and other elements. Three distinct types of CM splits were considered, including;

- Minimizing the ascent stage module volume to the greatest extent possible with augmented living space and EVA support for the surface phase of the mission;
- Providing a single CM for all crew support functions while segmenting the airlock functions necessary for routine exploration of the lunar surface; and
- Combining all CM and airlock functions into one element.

In all options, the descent stage provides the necessary transportation function of the ascent stage and living module to the lunar surface. In addition, it provides the LOI propulsion of the LSAM/CEV stack into lunar orbit.

Configuration Concept 1: Minimized Ascent Stage

The emphasis of this configuration layout was to minimize the overall size of the ascent stage to the greatest extent possible. This necessitated the split of the key functional requirements into the following segments, as illustrated in **Figure 4-39**:

- Ascent Stage: The ascent stage provides habitation and crew support during both the descent and ascent phases of the lunar landing mission. It also provides the necessary ascent propulsion for the ascent phase. A docking mechanism for rendezvous with the CEV is provided as well as a retractable attachment for crew transfer to the living module post-lunar-landing. A quick assessment of the interior layout and dimensions required for the crew for both standing and sitting postures was conducted. This assessment included combinations of (1) all crew standing, (2) two crew sitting and two crew standing, and (3) all crew sitting. Human habitability data indicated that the configuration of all crew standing, which was the method utilized during the Apollo missions, provided the minimum overall ascent module layout. This configuration provides approximately 10 m³ of total pressurized volume and 5.5 m³ of equivalent habitable volume.
- Living Module/Airlock: The living module supports the crew during the lunar surface phase of the mission. This includes all crew habitation during the surface stay of up to 7 days. This element also provides all necessary EVA support, including access to the surface via an airlock, EVA suit storage, and maintenance. A similar quick assessment of the interior layout of the living module was conducted. An integrated two-person airlock is configured at one end of the living module to provide the crew routine access to the lunar surface. The living module provides approximately 16.7 m³ of total pressurized volume and 8.7 m³ of equivalent habitable volume, with the airlock providing another 7.9 m³ and 5.1 m³ of pressurized and habitable volume, respectively.

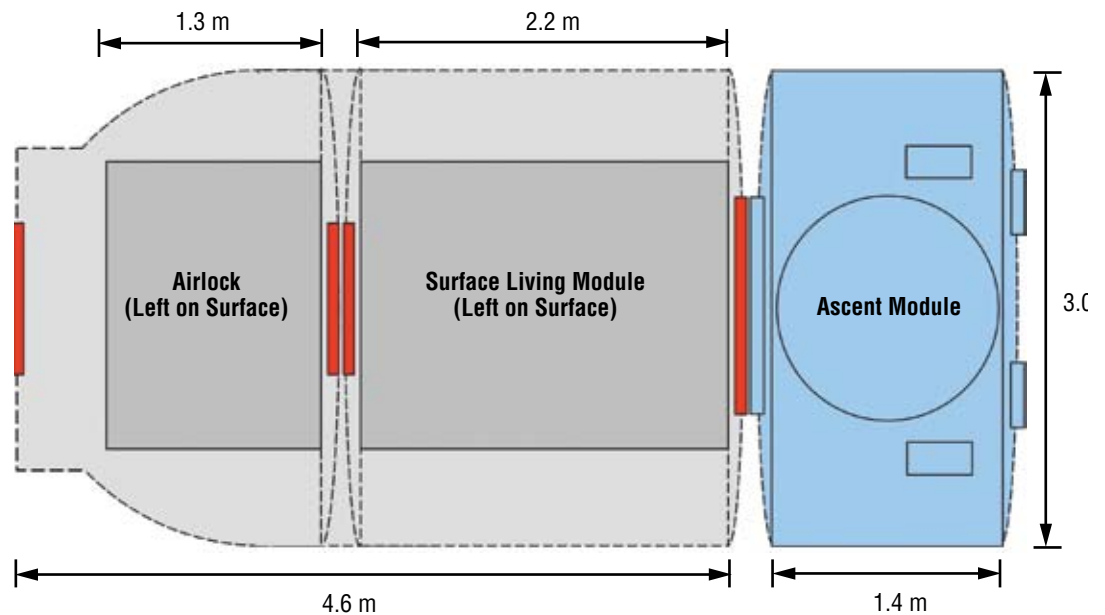

Figure 4-39. LSAM Minimized CM Vehicle Configuration

Configuration Concept 2: Separate Airlock

The emphasis of this configuration layout (**Figure 4-40**) was to provide a single crew module for the sortie missions (descent, surface stay of up to 7 days, and ascent) with a separate airlock. Surface-specific EVA functions, including an airlock as well as other EVA support functions, were provided via an airlock that remains on the lunar surface. This necessitated the split of the key functional requirements into the following segments:

- **Living Module/Ascent Stage:** The living module/ascent stage provides habitation and crew support during both the descent and ascent phases, as well as the surface phase of the lunar sortie mission. It provides the necessary ascent propulsion for the ascent phase. A docking mechanism for rendezvous with the CEV is provided as well as a retractable attachment to the airlock. This configuration provides approximately 16.7 m³ of total pressurized volume and 8.7 m³ of equivalent habitable volume.
- **Airlock:** A separate two-person airlock is configured at one end of the living module to provide the crew routine access to the lunar surface. A retractable access port provides the necessary separation between the airlock and the CM prior to ascent. The airlock module provides approximately 7.9 m³ of total pressurized volume and 5.1 m³ of equivalent habitable volume.

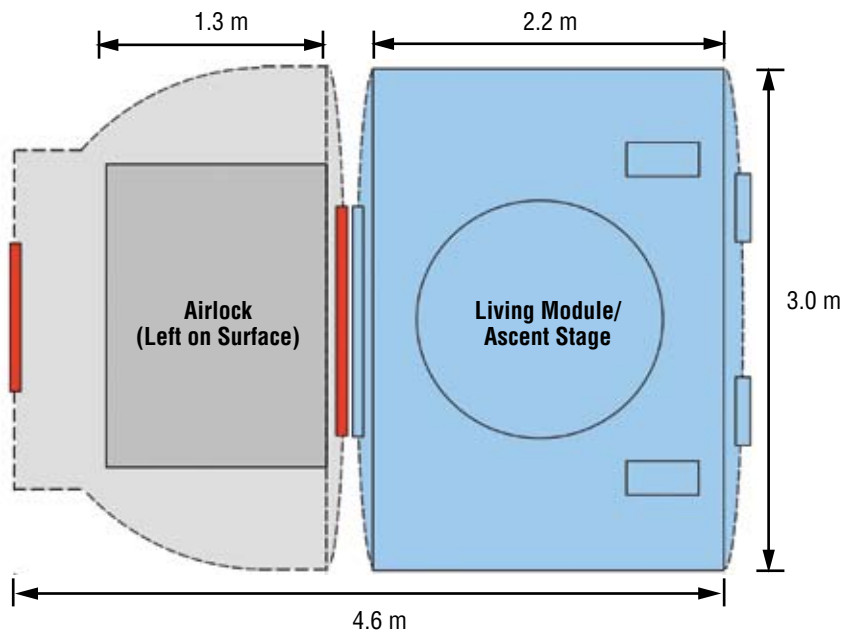

Figure 4-40. LSAM Separate Airlock Configuration

Configuration Concept 3: Combined Module

The emphasis of this configuration layout was on providing a single CM for the sortie missions (descent, surface stay of up to 7 days, and ascent) with an integrated airlock (Figure 4-41). This configuration layout provides the necessary ascent propulsion for the ascent phase. A docking mechanism for rendezvous with the CEV is also provided. In addition, an integrated two-person airlock is configured at one end of the living module to provide the crew routine access to the lunar surface. This configuration provides approximately 24.6 m³ of total pressurized volume and 13.8 m³ of equivalent habitable volume within the combined module.

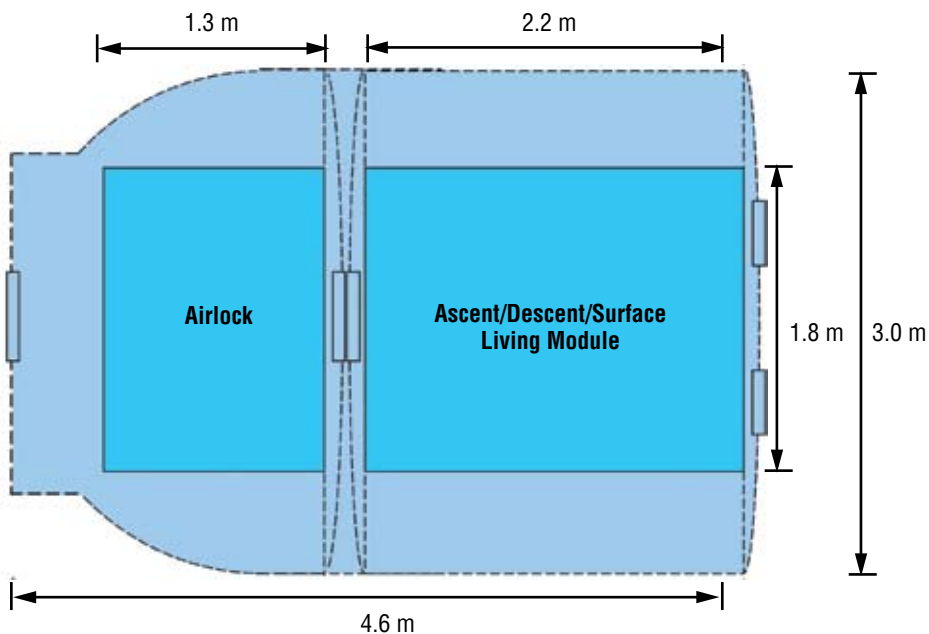



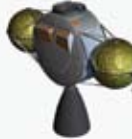





Figure 4-41. LSAM Combined Module Configuration

LSAM Configuration Summary

The Envision spacecraft sizing tool was used to perform quick performance trade assessments of the three vehicle configurations. Mass estimates for the ascent stage, living module, and descent stage performance were developed, a summary of which is provided in **Table 4-21**. As can be seen from this table, all three configurations land approximately the same mass on the lunar surface, in the 10-mT range. It is also interesting to note that integrated vehicle designs, such as the combined approach of Concept 3, provide better overall mass efficiency due to the synergistic design. This efficiency is gained through the elimination of additional redundancy of similar functions required by high degrees of separation of vehicle functions, as well as additional attachments required for segmented pressurized elements. Conversely, Concepts 1 and 2 leave behind potentially useful vehicle assets which could be used for future missions to the same landing site.

Table 4-21. LSAM Configuration Trade Mass Summaries

	Concept 1: Minimized Ascent			Concept 2: Separate Airlock		Concept 3: Combined	
	Ascent Stage	Living Module	Descent Stage	Ascent Stage	Descent Stage	Ascent Stage	Descent Stage
							
1. Structure	604 kg	673 kg	749 kg	712 kg	749 kg	714 kg	749 kg
2. Protection	60 kg	70 kg	275 kg	70 kg	266 kg	70 kg	265 kg
3. Propulsion	624 kg	00 kg	2,003 kg	664 kg	1,915 kg	678 kg	1,908 kg
4. Power	427 kg	260 kg	448 kg	427 kg	448 kg	427 kg	448 kg
5. Control	00 kg	00 kg	00 kg	00 kg	00 kg	00 kg	00 kg
6. Avionics	540 kg	161 kg	145 kg	540 kg	145 kg	540 kg	145 kg
7. Environment	349 kg	526 kg	233 kg	541 kg	177 kg	541 kg	177 kg
8. Other	710 kg	355 kg	576 kg	710 kg	534 kg	355 kg	530 kg
9. Growth	663 kg	409 kg	886 kg	733 kg	847 kg	665 kg	844 kg
10. Non-Cargo	247 kg	644 kg	1,567 kg	836 kg	1,475 kg	845 kg	1,468 kg
11. Cargo*	00 kg	00 kg	4,418 kg	00 kg	1,265 kg	765 kg	500 kg
12. Non-Propellant	41 kg	55 kg	510 kg	60 kg	463 kg	60 kg	463 kg
13. Propellant	3,545 kg	00 kg	29,537 kg	4,278 kg	27,653 kg	4,543 kg	27,489 kg
Dry Mass	3,979 kg	2,455 kg	5,316 kg	4,396 kg	5,081 kg	3,990 kg	5,066 kg
Inert Mass	4,225 kg	3,098 kg	11,301 kg	5,232 kg	7,821 kg	5,600 kg	7,033 kg
Total Vehicle	7,811 kg	3,153 kg	41,348 kg	9,570 kg	35,937 kg	10,203 kg	34,985 kg

* Cargo includes airlock and/or living module

The LSAM configuration study investigated basic differences in vehicle design and configuration. Crew size and mission durations were fixed, and limited mission mode and propulsion options effectively narrowed the LSAM trade space. LV shroud diameter was found to dictate the height of the hydrogen tanks needed for the descent stage, while the size of these tanks will impact the opportunities to integrate cargo or habitable volumes into the descent stage. The surface crew cabin could be divided into pressurized segments that could serve as ascent stages or habitable volumes left on the surface, but this separation increases the overall LSAM mass.

ESAS LSAM Configuration

Based on the results of the LSAM configuration trade studies, a combined CM design was chosen as a POD for future lander design studies. This concept was chosen to both provide the required airlock function and simplify ascent and descent stage interfaces. The description and mass property breakouts presented in this section are the result of additional lander analysis and refined subsystem mass estimation using the Envision sizing tool.

It was recognized, however, that returning this large pressurized volume of the combined crew cabin/airlock to lunar orbit does not provide the opportunity to utilize delivered pressurized volumes as elements of an incrementally deployed base. Further design work will refine the LSAM layouts, as well as define approaches for utilizing the remaining surface assets and the necessary resources required to keep those elements active for future use.

Ascent Stage Description

The reference LSAM concept for the ESAS 1.5-launch EOR–LOR architecture is a two-stage, single-cabin lander similar in form and function to the Apollo LM. The LSAM ascent stage, in conjunction with the descent stage, is capable of supporting four crew members for 7 days on the lunar surface and transporting the crew from the surface to lunar orbit. The ascent stage assumes an integrated pressure-fed oxygen/methane propulsion system, similar to the CEV SM, to perform coplanar ascent to a 100-km circular lunar orbit, rendezvous and docking with the CEV, and self-disposal following separation from the CEV. A single 44.5-kN (10,000-lbf) ascent propulsion system and sixteen 445-N (100-lbf) RCS thrusters are used for vehicle maneuvering and attitude control. Spherical ascent stage propellant tanks are sized to perform up to 1,866 m/s of ascent propulsion system and 22 m/s of RCS delta-V.

The LSAM pressure vessel is a horizontal short cylinder 3.0 m in diameter and 5.0 m long to provide 31.8 m³ of pressurized volume for the crew during lunar operations. A nominal internal atmospheric pressure for the ascent stage of 65.5 kPa (9.5 psia) with a 30 percent oxygen composition has been assumed. The LSAM's notional EVA strategy while on the lunar surface is daily EVA with all four crew members simultaneously egressing the vehicle. For missions lasting beyond 4 days, a rest day between EVAs may be required. Unlike the Apollo LM, the LSAM ascent stage crew cabin includes a bulkhead to partition a section of the pressurized volume, which can serve as an internal airlock. Thus, crew members don their surface EVA suits in the airlock, depressurize the airlock, and egress the vehicle.

Ascent stage power generation capabilities include rechargeable batteries for the 3 hours from liftoff to docking with the CEV. Power generation for all other LSAM operations prior to liftoff is provided by the descent stage.

An illustration of the reference LSAM ascent stage is shown in **Figure 4-42**.



Figure 4-42. LSAM Ascent Stage

Ascent Stage Mass Properties

Table 4-22 below provides overall vehicle mass properties for the LSAM ascent stage. The mass properties reporting standard is outlined in JSC-23303, Design Mass Properties.

Table 4-22. LSAM Ascent Stage Mass Properties

LSAM Ascent Stage	% of Vehicle Dry Mass	Mass (kg)	Volume m ³
1. Structure	20%	1,025	0
2. Protection	2%	113	1
3. Propulsion	17%	893	11
4. Power	11%	579	1
5. Control	0%	0	0
6. Avionics	8%	385	1
7. Environmental	17%	896	12
8. Other	7%	382	1
9. Growth	17%	855	5
10. Non-Cargo		834	5
11. Cargo		0	0
12. Non-Propellant		131	0
13. Propellant		4,715	0
Dry Mass	100%	5,128	
Inert Mass		5,962	
Total Vehicle		10,809	

Descent Stage Description

The LSAM descent stage, shown in Figure 4-43, is used in crewed lunar exploration missions to insert the CEV into LLO, land the ascent stage and cargo on the surface, and provide the vehicle's life support and power generation capabilities during an assumed 7-day lunar surface stay. The descent stage uses a pump-fed oxygen/hydrogen main propulsion system to perform LOI and coplanar descent from a 100-km circular lunar orbit. Four 66.7-kN (15,000-lbf) descent propulsion system engines derived from the RL-10 engine family are used for vehicle maneuvering while the ascent stage RCS is used for combined-vehicle attitude control. The descent propulsion system engines are arranged symmetrically around the vehicle centerline at the base of the descent stage.

Six cylindrical hydrogen and two cylindrical oxygen descent stage tanks are included on the LSAM to store the propellant needed to perform up to 1,390 m/s of LOI delta-V with the CEV and ascent stage attached, and 1,900 m/s of descent delta-V with only the ascent stage attached. Although the tanks are sized to hold the maximum propellant quantity needed to perform any possible descent stage mission, the tanks are only filled to the level needed for the specific mission being performed. For example, a long-stay lunar outpost mission to the north pole may only need a minimum-energy coplanar LOI maneuver (845 m/s), while a 7-day sortie to the far side south pole-Aitken Basin Floor may require a much larger LOI due to the plane change at arrival (1,100 m/s). Propellant mass not used for LOI delta-V can maximize the amount of useful cargo mass delivered to the lunar surface. The eight LSAM propellant tanks are mounted around the descent stage in a ring arrangement, leaving two open bays on opposite sides of the stage exterior for surface access and cargo stowage and a circular opening along the vehicle centerline for housing the single ascent stage engine nozzle. In addition to supporting its own propulsion system, the descent stage structure also serves as a support system and launch platform for the ascent stage, provides attachment for a four-leg landing gear system, provides for crew access to the surface, and serves as the attachment point to the EDS.

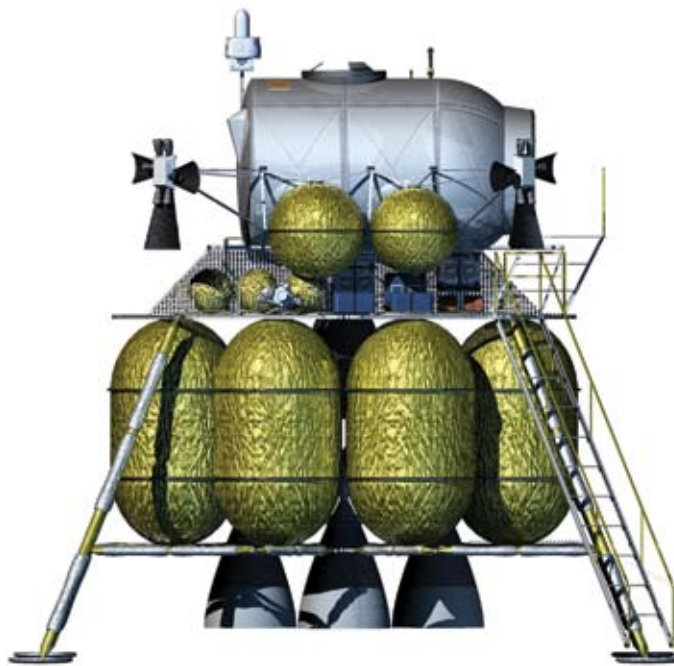

Figure 4-43. LSAM

Three Proton Exchange Membrane (PEM) fuel cells on the descent stage provide LSAM power generation from Earth launch to lunar ascent. Oxygen reactant for the fuel cells is stored in the oxygen propellant tanks, while hydrogen reactant is stored in the hydrogen propellant tanks. The descent stage also contains the gaseous nitrogen, potable water, and water storage systems needed for the mission up to lunar ascent. These systems were included on the descent rather than the ascent stage to avoid the penalty of lifting unnecessary mass back to lunar orbit. Finally, the descent stage provides the mounting location for the active thermal control system radiators. LSAM heat rejection following liftoff from the lunar surface is accomplished using a fluid evaporator system.

Table 4-23 below provides overall vehicle mass properties for the LSAM descent stage assuming a 7-day sortie mission to the far side south pole-Aitken Basin Floor. The mass properties reporting standard is outlined in JSC-23303, Design Mass Properties.

Table 4-23. LSAM Descent Stage Mass Properties

LSAM Descent Stage (Sortie Mission)	% of Vehicle Dry Mass	Mass (kg)	Volume (m ³)
1. Structure	18%	1,113	0
2. Protection	1%	88	0
3. Propulsion	38%	2,362	93
4. Power	8%	468	0
5. Control	1%	92	0
6. Avionics	1%	69	0
7. Environmental	5%	281	12
8. Other	10%	640	1
9. Growth	17%	1,023	5
10. Non-Cargo		1,033	5
11. Cargo		2,294	0
12. Non-Propellant		486	0
13. Propellant		25,105	0
Dry Mass	100%	6,137	
Inert Mass		9,464	
Total Vehicle		35,055	

4.2.5.1.4 Outpost Deployment Strategies

The above discussion of the LSAM configuration is incomplete without considering how the lander will be used in the deployment of the lunar outpost. **Section 4.3.5, Lunar Surface Traffic Model**, introduces lunar surface operations, and **Section 4.3.8, Outpost Deployment Studies**, discusses lunar outpost deployment in more depth. **Appendix 4F, Alternative Outpost Deployment Options**, explores other alternatives. However, in order to arrive at a lander configuration that will become the basis for the remaining Cycle 3 performance analysis, some discussion of the capabilities of sortie missions and the transition to outpost missions is necessary.

Several outpost deployment strategies were considered, including delivery of outpost elements on large cargo landers and the incremental buildup of an outpost using the excess cargo carrying capacity of lunar sortie missions. The initial ESAS outpost deployment strategy was based on the premise of a short series of 15- to 20-mT landed cargo missions emplacing large, monolithic payloads. This initial outpost deployment approach was to be traded against alternate outpost deployment strategies to assess the degree to which the early sortie missions could be leveraged to enable an incremental deployment of the outpost. As a major element of the outpost, the habitat received special attention, due to its size and difficulty to separate into smaller components. The team was asked to consider if smaller habitable volumes from crewed LSAMs could be used to incrementally construct a habitat using smaller ascent stages, leave-behind crew cabin modules, and deployed payload modules.

Dedicated Cargo Lander Strategy

The initial ESAS outpost deployment strategy deployed the core outpost in three dedicated “cargo” flights and a fourth mission that prepositions a backup LSAM. The fifth flight to the outpost delivers the first crew in an LSAM that will be used to return the second crew complement to Earth. The outpost is completed after five dedicated cargo flights, and is shown in **Figure 4-44**.

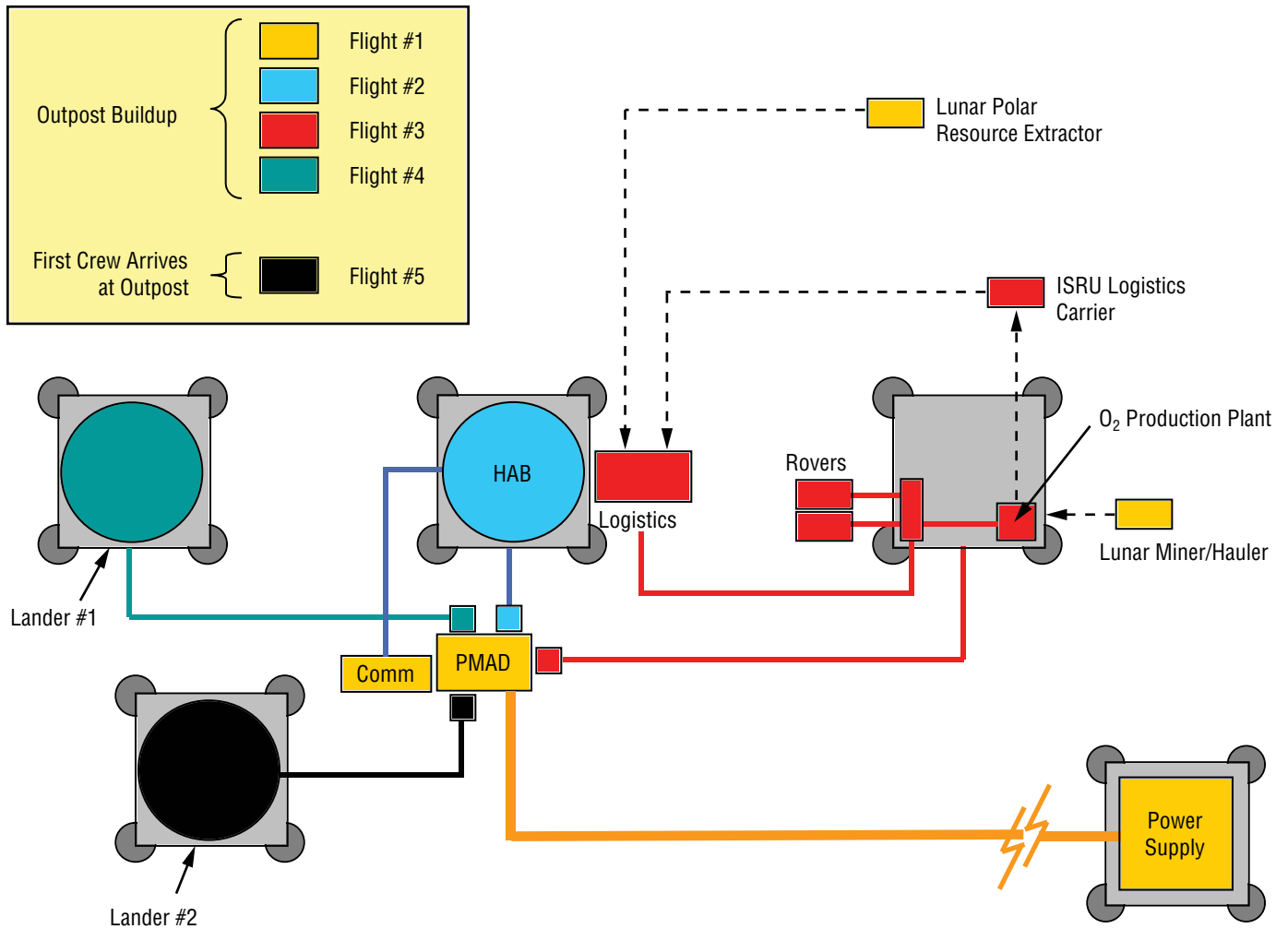

Figure 4-44. Core Outpost Schematic

This initial strategy corresponds to the “pointer” location shown in **Figure 4-54** (which appears later in the report in **Section 4.3.5, Lunar Surface Traffic Model**), and serves as a starting point for the analysis of outpost deployment strategies. A number of key assumptions was used by the ESAS team to formulate the initial outpost deployment strategy:

- The outpost IOC will be 2022;
- The outpost deployment phase will be preceded by a lunar sortie mission phase of approximately 2–4 years; however, sortie missions are not incorporated as part of the outpost deployment strategy;
- The outpost will maintain a continuous, sustained four-crew member presence with crew rotations every 6 months;
- The outpost will be deployed on an elevated feature at a polar region that provides long durations of uninterrupted lighting;
- The outpost is not in continuous view of Earth;
- The descent stage is capable of delivering 15 metric tons (mT) to the lunar surface;
- Deep Space Network (DSN) (flight navigation) and Tracking and Data Relay Satellite (TDRS) (communication) resources are available for continuous support of lunar operations or can be modified to provide this service;
- A nuclear reactor serves as the primary outpost power source; and
- Precursor missions have accomplished the following tasks:
 - Demonstrated ISRU technologies such as O₂ production, H₂/H₂O extraction, and excavation of regolith; and
 - Developed an enhanced lunar gravity potential model.

The purpose of the outpost is to establish an initial set of core lunar surface operating capabilities. Additionally, as mission objectives become more challenging and extensive, surface operations will require an evolved set of surface capabilities. Initial capabilities include the following:

- Enable a continuous, sustained human presence;
- Enable frequent local (3-km radius) and near-field (15-km radius) Extra Vehicular Activities (EVAs);
- Enable in-depth, in-situ data collection and analysis:
 - Field experiment deployments;
 - Lunar geosciences; and
 - Human physiological adaptation.
- Enable ISRU demonstrations/pilot operations:
 - Regolith excavation and transportation;
 - Oxygen production from regolith; and
 - Long-term cryogenic fluid storage and transfer of oxygen.

Evolved capabilities include the following:

- Maintain and grow logistics chain:
 - Landing and traversable zone build-up and clearance; and
 - Lunar-produced logistics augmentation.
- Enable mid-field (30 km radius) and far-field (30+ km radius) EVAs;
- Provide the ability to add additional lunar-based science infrastructure:
 - Space physics; and
 - Astronomy.
- Enable large-scale ISRU production:
 - Large-scale regolith excavation and manipulation;
 - Consumable and propellant production; and
 - Surface construction (pads, berms, roads, etc.).

The design principles that were employed in the creation of the outpost deployment strategy were:

- Landed elements should not be required to move unless absolutely necessary;
- Autonomous activities (e.g., for locomotion or payload manipulation) should only be performed if absolutely necessary;
- Required crew operations for outpost deployment should be limited and simple;
- Landed elements should be delivered on common cargo descent stages;
- Common functions (e.g., power distribution) should be performed by common means; and
- The logistics supply chain should require minimal crew time and robotic manipulation.

“Incremental Build” Strategy

Cost analyses performed in parallel with ESAS identified the predeployed outpost as a major architecture cost driver. This led the team to analyze alternate methods of deploying the outpost, included combining sortie and cargo delivery functions into a single vehicle and delivering the components of the outpost in smaller (2- to 5-mT) elements.

Specifically, the second concept examined whether outpost assets could be built from pieces that were left behind from previous missions. This included examination of pieces that were used by the sortie mission crew but left behind, as well as pieces that were carried as payload on the sortie missions for the sole purpose of future assembly into usable assets.

The same assumptions for outpost deployment listed for the cargo lander strategy were to be used for all outpost deployment alternatives. For the “incremental build strategy,” two assumptions were modified as follows:

- The outpost deployment missions can begin as early as the first sortie mission and will increase in capability with each subsequent sortie visit; and
- The outpost will gradually build to a permanent four-crew member presence.

As a first step, the ESAS team examined which outpost assets, if any, made sense to break into modular pieces. Therefore, the team reviewed the manifest of outpost elements, breaking the list into three categories: (1) Less than 2,000 kg; (2) between 2,000 kg and 10,000 kg; and (3) greater than 10,000 kg. The general feeling was that, if an element had a mass less than 2,000 kg, there was no reason to try to break it into smaller pieces. If an element was in the 2,000-kg to 10,000-kg range, it was a potential candidate, but must have extremely good rationale and prove to be relatively simple. If an element had a mass greater than 10,000 kg, it was a candidate that deserved a thorough review. The outpost deployment manifest is as follows:

- Less than 2,000 kg
 - Rover Logistics Box (100 kg),
 - Two Unpressurized Rovers (500 kg),
 - ISRU Lunar Miner/Hauler (600 kg),
 - ISRU O₂ Pilot Plant (800 kg),
 - Inchworm (900 kg),
 - ISRU Logistics Carrier (1,000 kg),
 - ISRU Lunar Polar Resource Extractor (1,200 kg), and
 - Power Management and Distribution (PMAD)/Communications Center (1,570 kg);
- 2,000 kg – 10,000 kg
- Greater than 10,000 kg
 - Logistics Module (10,000 kg),
 - Pressurized Rover (10,000 kg) (Evolved Capability),
 - Primary Surface Power Source (11,500 kg), and
 - Habitat Module, not outfitted (15,000 kg).

The elements fell within the two categories: (1) 1,570 kg and less and (2) 10,000 kg or greater. The evolved payload unloader was the one item that fell into the “potential candidate” range, but, since this element is a relatively sizable mobile truck with an integrated scissor-jack lift, it was not conducive to lunar surface assembly operations. Therefore, the team focused on the four items in the “Greater than 10,000 kg” category.

Logistics Module

The logistics module was the best candidate for splitting into separate pieces, but not in the way that was originally envisioned at the beginning of this task (i.e., split into pieces for future assembly). Instead, it was felt that this element could possibly be eliminated altogether, if the assumption regarding the down-mass cargo capability of the descent stage was changed. The original assumption for the descent stage was that it would have a down-mass cargo capability of 15 mT. During a human mission, this meant that a cargo of approximately 500 kg could be carried to the lunar surface, given the mass of the LSAM ascent stage. If the down-mass capability of the descent stage was to be increased by 2,000 kg to 5,000 kg, the potential exists to carry the required logistics for the habitat with each crew increment. To be certain of this conclusion, a detailed assessment of the habitat logistics resupply requirements should be performed.

If the assumption regarding the descent stage's down-mass cannot be made, it is not clear that it would make sense to partition this element into modular pieces. The purpose of the logistics module was to deliver fresh supplies (fluids and pressurized and unpressurized cargo) to the habitat to support each 6-month crew increment (one logistics module per crew increment). While it is true that this element could be assembled on the lunar surface, or could exist as three separate entities, the purpose for doing so is not evident. Cargo missions would still be required to deliver logistical materials to the lunar surface. These logistical materials will already have been packaged on Earth according to their requirements (pressurized, unpressurized, or in holding tanks). Because this packaging would have been needed during the transit phases and, therefore, delivered to the lunar surface, it would not make sense to transfer from one set of packaging to another (the logistics module). Therefore, this idea was not pursued.

Pressurized Rover

The pressurized rover would seem to be a difficult item to build on the lunar surface. Simplistically, a person could envision a pressurized rover as a small habitat placed on a mobile chassis. Therefore, one could envision that sortie mission hardware could be leveraged to construct a pressurized rover on the lunar surface, if a mobile chassis was delivered to the surface and the crewed version of the LSAM had a configuration that left a habitable volume behind on the lunar surface. However, this idea is extremely hard to implement. Many of the same problems associated with using LSAM pieces to construct a habitat also apply to this approach. In brief, some of the major problems are:

- After severing all power, data, fluid, and structural connections with the LSAM descent stage, the habitable module must be unloaded from the descent stage (e.g., crane, placed on wheels, etc.);
- The habitable volume must be moved to the vicinity of the pressurized rover chassis;
- The habitable volume must be lifted (e.g., crane) and placed onto the chassis, and all required connections must be made—power, data, fluid, structural;
- The habitable volume will require all systems (e.g., ECLSS, Thermal Control System (TCS), etc.) that are required to create a surface habitable volume—this means that duplicate systems will be required between the ascent stage and the habitable volume that is left behind;
- The habitable volume's systems must be designed with a significantly longer lifetime than is needed to support sortie missions and must be able to accommodate multiple reuses; and
- No Earth-based integrated validation of the final configuration will be possible.

There is a possibility that the chassis could be pre-integrated with the portion of the LSAM's habitable volume that is left on the lunar surface. However, this has implications as well. The first implication is that, in order to score out the proper mass allocation and interfaces to be able to carry a chassis as an integrated part of the LSAM configuration, much more would need to be known about the pressurized rover during the LSAM design period. This will probably not be the case for a couple of reasons. First, the pressurized rover chassis will probably be designed from lessons learned from the unpressurized rover design after years of operations. Secondly, pressurized rovers are not needed until several years into the lunar surface program; therefore, there will probably not be an element of intense design scrutiny until several years after the LSAM design is underway (or is already developed).

A second implication of this approach is the permanent impact it would have on the LSAM design. As stated previously, the proper mass allocations and interfaces would need to be designed into the LSAM. If this were the case, three options would be present:

- Deliver a mock chassis to the lunar surface on every flight so that the components of the LSAM that depend on interfaces of the chassis (e.g., structural) would have their required support. This results in the delivery of extra mass to the lunar surface that is essentially wasted and would not otherwise be flown;
- Deliver a real chassis to the lunar surface on every flight so that the components of the LSAM that depend on interfaces of the chassis (e.g., structural) would have their required support. This results in the delivery of a usable pressurized rover to the lunar surface with each crewed LSAM—which probably results in developing many more pressurized rovers than required;
- Design the LSAM such that no components of the LSAM are dependent on the interfaces of the chassis, but can accommodate them when flown. This would require a significant engineering effort and a high degree of knowledge about the pressurized rover at the time of the LSAM design efforts. The advantage of this approach is that it would free the chassis' mass allocations for use by other cargo.

None of the three options are ideal. The third option would provide the most efficient use of LSAM capabilities, but requires knowledge of the pressurized rover at an extremely early point in the program, which is probably impractical.

Primary Surface Power Source

The primary surface power source is a potential candidate for splitting into modular pieces, but only if the assumption is made that it is not a nuclear fission power source. If that was the case, there are two ways in which modularizing the power source could be of benefit to the outpost deployment strategy. The first way entails leveraging spent LSAM descent stages with their associated power generation/storage/distribution systems to serve as the outpost's primary power source. The second way potentially eliminates the first outpost deployment flight (delivery of the nuclear power source and PMAD Center) by delivering the power source in smaller pieces along with the crewed LSAM missions.

The first candidate approach involves linking multiple LSAMs together on the lunar surface with power cables. This idea proves to be marginally viable only if the power system's mass allocation can be increased to use the 500-kg cargo down-mass capability of the crewed LSAM missions and to use the descent tanks for storage of fuel cell reactants. This concept was examined as a follow-on activity to the development of the initial outpost deployment strategy task. The team members who performed the analysis found that, if the power system's mass increased to use the entirety of its allocation (800 kg), plus the 500 kg from the cargo down-mass capability of the LSAM, each LSAM could be modified to provide approximately 4 kWe during the lunar day and approximately 2.7 kWe during the lunar night. Because previous outpost power requirement estimates found that 50 kWe is a minimum threshold for full-scale outpost operations, this means that 12–13 LSAMs would need to be linked together, if the outpost could operate on 32–35 kWe during the periods of lunar night (ranging from a few days at select locations at the polar regions to 14 days at most locations on the lunar surface). If a decreased lunar night operating power is not acceptable, 18–19 LSAMs would need to be linked together, providing 72–76 kWe during the lunar day. This approach also means that the cargo-carrying capabilities of the crewed LSAM missions would be completely consumed by power source systems, unless the descent stage's capabilities are increased.

The second candidate approach involves delivering a solar/Regenerative Fuel Cell (RFC) power source in smaller pieces as cargo on the crewed LSAM missions, without trying to connect LSAMs together. As with the first approach, this means that the LSAM’s cargo down-mass capabilities are being consumed by power source systems. **Table 4-24** summarizes masses associated with a few 25-kWe and 50-kWe solar/RFC systems that are packaged and pre-integrated on Earth.

Case	Power Level (kWe)	Total System Mass (kg)		
		Gaseous	All Cryogenic	O2 Cyrogenic
Equatorial – Noon, Hot Case	25	18,654	15,800	16,502
45° Lat – Noon, Sun Off-Pointed Case	25	19,069	16,550	16,970
85° Lat – Polar Sun-Tracking Case	25	18,339	15,076	15,931
Shackleton North Rim Only	25	8,986	6,853	8,008
Shackleton North Rim Only	50	15,927	14,970	10,509

Table 4-24. Solar/RFC Total System Masses for Select Locations

The approach for modularizing a solar/RFC system was not studied, but as can be seen in **Table 4-24**, the total system masses for the non-Shackleton Crater locations (25-kWe systems) range from approximately 15 to 20 mT. Therefore, if the assumption limiting the LSAM’s cargo down-mass to 500 kg is increased to allow a down-mass capability of approximately 5,000 kg, a the solar/RFC system could be delivered in 5-mT pieces. However, this introduces significant inefficiencies (e.g., mobility systems would be required for each piece), and the design must accommodate a modular approach, which then introduces design complexities. Therefore, the total system masses listed in **Table 4-24** should be expected to grow if a modular approach were to be pursued.

Habitat Module

The habitat received special attention as a part of this effort. The main question was whether habitable volumes from crewed LSAMs could be used to construct the habitat. This would require LSAM configurations with minimized ascent stages and leave-behind habitable modules as part of the outpost deployment strategy. Based on the findings from this extensive effort, the team strongly recommended against this approach.

One of the key findings from this effort was that the habitable modules would be severely deficient in the types of systems that would be incorporated into their design, due to the functional allocation required by the LSAM. Without an independent set of core functions (e.g., life support, thermal control, etc.), the habitable modules were severely lacking and did not provide a good basis from which a habitat could be constructed. However, it was felt that different approaches to habitat modularization might exist that could help decrease early program costs without introducing significant complexities. An example of this might be to develop a fully functional one-story habitat, rather than the originally desired two-story habitat, and add habitable volumes to this habitat as the lunar mission progresses. This would establish a core functional environment on the lunar surface (albeit limited in size) to which the program can build upon as desired. This approach would also allow for a low-risk environment for testing aggressive habitat technologies, such as inflatable add-on modules, at a pace that the program deems acceptable, while always ensuring that there is the core functional habitat available to the crew.

Outpost Deployment Strategy Conclusions

Lunar surface outpost deployment strategy options were studied to determine the order and manifest of the flights required to deploy a core set of lunar surface capabilities for sustained, concentrated lunar operations and to provide for the evolution of the surface capabilities as the lunar program progresses. The cost distribution for different outpost deployment strategies was found to be highly dependent on the time frame over which the outpost is deployed and the number of unique element developments required.

A core set of elements is required in order to enable the key capabilities associated with maintaining a human presence on the lunar surface (e.g., habitat, EVA suits, etc.). Additional elements can be added to the architecture depending on the desire to seek greater degrees of self-reliance (e.g., ISRU) or to seek to operate in operationally challenging areas (e.g., out of constant view of Earth). It should not only be expected that performance requirements will grow or change with time (e.g., expanding EVA traverse capabilities), but they should change to take advantage of a growing set of surface assets and crew availability (e.g., payload unloading strategies).

The ESAS concluded that a reasonable approach for outpost deployment can be achieved by incrementally deploying outpost elements, and incrementally gaining capability over time.

Appendix 4F, Alternate Outpost Deployment Strategies, discusses additional deployment strategies.

4.2.5.2 Analysis Cycle 3 Performance

4.2.5.2.1 1.5- and 2-Launch Architectures

Analysis Cycle 3 focused on comparing the performance of the 1.5-launch EOR–LOR architecture to the 2-launch EOR–LOR and 2-launch LOR architectures after incorporating the final CEV CM shape and the results of the Cycle 3-focused trade studies. The final CEV shape and configuration was a 5.5-m base diameter, 32.5-deg sidewall angle capsule shape with no dedicated radiation shielding over and above that provided by the intrinsic design of the vehicle. The CEV SM and LSAM descent stage tanks are still designed to carry the maximum possible TEI and LOI propellant required; however, the vehicles will only load the propellant required to perform 7-day sortie missions to either the top 10 sites identified or long-stay outpost missions to a near-polar outpost. The LSAM ascent stage, which has a single combined CM, also includes an internal airlock for surface EVA. Pump-fed oxygen/hydrogen is used for the descent stage and pressure-fed oxygen/methane is used on the ascent stage and SM.

Figure 4-45 illustrates how CEV- and LSAM-injected masses vary with mission design requirements. The LSAM mass limit, as constrained by the performance of the CaLV and EDS, is shown as a function of CEV-injected mass. Because the EDS must perform TLI for both the CEV and LSAM, increased CEV mass decreases the LSAM mass that can be launched from Earth and injected to the Moon. The other mass limit comes from the performance capabilities of the CLV. The assumed LV can launch up to a 24.5-mT CEV to the insertion orbit in LEO. Since both lines maintain a 10 percent performance margin on the EDS and LV, if the combination of CEV and LSAM masses for a given mission fall within these limits, the in-space elements have a positive performance margin for additional mass growth or payload delivery capability. Lines of constant LOI delta-V are also plotted in the figure, showing the effect of delta-V and CEV mass on the LSAM, along with different TEI delta-Vs for a particular LOI delta-V. Constant TEI delta-V lines are vertical lines but were omitted in the figure for clarity.

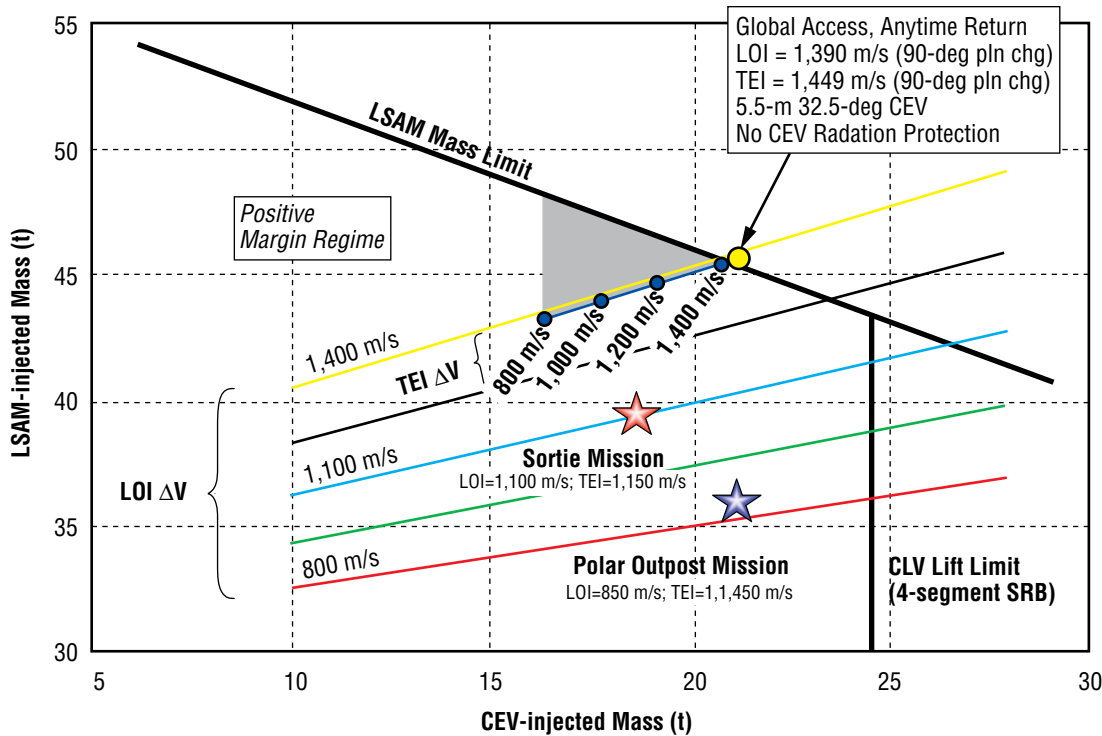





Figure 4-45. LSAM and CEV Mass Constraints for 1.5-Launch EOR-LOR

Three additional points are also plotted in the figure, representing three possible mission designs for the CEV and LSAM. The first point, indicated with a yellow circle, shows the cost of carrying 90-deg plane change capability on the CEV and LSAM for full global access and “anytime return” capability. While the CEV and LSAM propellant tanks are sized to carry that propellant mass, simultaneously including the mass on both vehicles is highly inefficient, as evidenced by the fact that the global access/“anytime return” trade demonstrated that LOI and TEI delta-V could be significantly reduced by simply loitering for a short while in LLO. Nonetheless, the LSAM-injected mass lies on the LSAM mass limit line, demonstrating that this capability is feasible, albeit with no additional performance margin. The second and third points, indicated with red and blue stars, represent the CEV and LSAM mass for 7-day missions to the top 10 sortie sites and long-stay missions to a polar outpost, respectively. Each mission has different TEI and LOI delta-V requirements, though both are comfortably within the LSAM mass and CLV lift limits. The polar outpost mission only requires a minimum energy coplanar LOI but may require a full 90-deg plane change to return to Earth (i.e., TEI) at any point during the long stay on the Moon. The 7-day sorties, though, require a plane change at LOI to set up a lunar parking orbit for minimum-energy anytime-ascent capability during the time on the surface, thus requiring greater LOI delta-V than the outpost mission. At the same time, since the surface mission only lasts 7 days, the full TEI plane change capability included with the outpost mission is not required here. Therefore, the CEV-injected mass is lower for the sortie mission than the outpost mission due to its lower TEI delta-V, while the LSAM-injected mass is higher, owing to its higher LOI delta-V.

Table 4-25 provides performance margins for the three LOR architecture variants using both Design Cycle 2 and Cycle 3 mission design assumptions. In Cycle 2, the descent stage and SM included the propellant mass needed for 90-deg plane changes at LOI and TEI. The CEV CM also included 2 g/cm² of supplemental polyethylene radiation shielding. Using these assumptions, the 1.5-launch EOR–LOR architecture had negative performance margins on its in-space elements. When Cycle 3 assumptions for a 7-day sortie are applied instead, the architecture has adequate performance margins and could deliver several tons of additional cargo mass to the lunar surface (if desired), similar to the 2-launch EOR–LOR and LOR architectures. The 1.5-launch EOR–LOR architecture has significantly less margin for the CEV than the others, as it uses the smaller CLV for launching the CEV and crew. The maximum mass margin is provided by the 2-launch EOR–LOR architecture.

Table 4-25.
Performance Margins
for Cycle 3 Architectures

Mission Scenario	Cycle 2 Assumptions <i>Global Access 4-Day Sortie, "Anytime Return," 2 g/cm² Radiation Protection</i>			Cycle 3 Assumptions <i>Top 10 Site Access for 7-Day Sortie, "Anytime Return," 0 g/cm² Radiation Protection</i>		
	1.5-Launch EOR–LOR	2-Launch EOR–LOR	LOR	1.5-Launch EOR–LOR	2-Launch EOR–LOR	LOR
 CEV Capsule	-475 kg	+4,795 kg	+2,585 kg	+795 kg <i>(limited by SRB lift & Polar Outpost mission)</i>	+7,900 kg	+2,920 kg
 CEV SM	-580 kg	+5,840 kg	+3,145 kg	+975 kg <i>(limited by SRB lift & Polar Outpost mission)</i>	+9,630 kg	+3,600 kg
 Ascent Stage	-230 kg	+3,220 kg	+2,150 kg <i>(LSAM does LOI)</i>	+1,285 kg	+4,540 kg	+2,815 kg <i>(LSAM does LOI)</i>
 Descent Stage*	-440 kg	+6,185 kg	+4,140 kg <i>(LSAM does LOI)</i>	+2,270 kg	+8,785 kg	+5,410 kg <i>(LSAM does LOI)</i>

*Descent stage includes 500-kg landed cargo.

4.2.5.2.2 Single-Launch Architecture Performance

The Design Cycle 3 studies also included an initial performance analysis of architecture excursions wherein the CEV, LSAM, and EDS are combined into a single launch similar to the Apollo lunar missions. In the ESAS final reference architecture (the 1.5-launch EOR–LOR architecture), the EDS and LSAM are first launched to Earth orbit using the heavy-lift CaLV with CEV and crew following within hours or days with a launch of the smaller SRB-derived CLV. The vehicles rendezvous and dock in LEO and, once mated, the combined stack departs for the Moon. The single-launch option differs from this mission mode in that the EOR and docking phases from the mission are eliminated. Instead of launching on the CLV, the CEV and crew launch with the CaLV on top of the LSAM–EDS stack. Eliminating the rendezvous phase shortens the total mission time by 3 days and reduces the CEV service propulsion system and RCS delta-V budget by approximately 150 m/s. With single-launch architectures, the only time spent in Earth orbit is 1–2 orbit revolutions for vehicle checkout and to phase for

lunar departure. Another difference with the single-launch option from the ESAS reference architecture comes with the configuration of the CaLV. The configuration must be modified to allow the CEV to launch on top of the vehicle. The payload shroud enclosing the LSAM in the baseline CaLV is replaced with an LSAM/CEV adapter that supports the gross mass of the CEV during launch and possibly also supports the mass of the LSAM as was done with the Saturn V. After ascent and TLI, the CEV separates from the adapter, the adapter panels are jettisoned to expose the LSAM docking mechanism, and the CEV transposes and docks with the LSAM. The remainder of the single-launch mission functions identically to the reference architecture.

Two single-launch mission options were analyzed to compare the missions' required trans-lunar injected mass against the capability of the modified CaLV. In the first option, the Cycle 3 vehicle designs for the CEV and LSAM were fully retained both in vehicle scale and in subsystem design, while propellant and other consumables were offloaded as needed to fit within the TLI mass constraint. This produced an architecture capable of transporting four crew to the lunar surface for up to 7 days while restricting surface access to near-equatorial landing sites only. In the second single-launch option, a full global surface access capability with anytime return was retained from the ESAS final reference architecture; however, the crew size was reduced from four to two. The Cycle 3 CEV and LSAM designs were likewise reduced in scale to accommodate the smaller crew. The following two sections describe the single-launch options in further detail. Note that the single-launch option analysis was limited to mass comparisons and the options have not been analyzed for risk, cost, or schedule impacts. Impacts will include major launch support structure and CaLV modifications, certification of the CEV and CaLV for human-rated launches on that vehicle, and others to be determined.

Mission Constraints with Current CEV/LSAM

This single-launch option retains the current CEV and LSAM configurations from the ESAS final reference architecture but constrains the mission capabilities to fit both elements on the modified CaLV. The mission still assumes a four-person crew size, 7-day sortie surface duration, and 500-kg cargo delivery to the surface. The CEV and LSAM shapes, scales, and subsystem designs from the reference architecture are also still assumed. Mass savings occur by restricting access to the lunar surface to landing sites located within a few degrees of the lunar equator—sites such as the Mare Smythii basin located at 2.5°N, 86.5°E. Restricted surface access allows the CEV to carry less propellant to perform TEI, thereby reducing its mass. The delta-V for TEI assumed in the reference architecture, approximately 1,150–1,200 m/s, can be reduced to 950 m/s while still retaining full-entry coazimuth control at Earth. The difference between the reference architecture and this single-launch option is that near-equatorial sites do not require large plane changes to align the CEV parking orbit for anytime Earth return, while mid-latitude and near-polar sites do. Near-equatorial sites also require much less delta-V for LOI and, when combined with a lower CEV mass, the required propellant quantity on the LSAM descent stage can be greatly reduced. As with the TEI burn, restricting lunar surface access can eliminate a large plane change during LOI. The required delta-V has been reduced from 1,100 m/s in the final reference architecture to 900 m/s in this restricted-access option.

The combined effect of emplacing mission constraints while retaining the current CEV and LSAM configurations is a required trans-lunar injected mass of 55.6 t. The modified CaLV assumed for the single-launch options, including mass growth, performance reserves, and 10 percent margin, can deliver 54.6 t to TLI. Therefore, given the close match in injected mass requirement to LV capability, this single-launch option was tentatively considered technically feasible, yet it does require a portion of the 10 percent margin to be used to make up the 1.0 t performance shortfall. This mission option is summarized in **Figure 4-46**.

Option	Surface Access	Crew Size	CEV	LSAM	Required TLI Injected Mass
ESAS Cycle 3 Vehicle w/ Restricted Surface Access	7-Day Near-Equatorial Sorties Only	4 Crew, all to lunar surface	<ul style="list-style-type: none"> • 5.5-m, 32.5-deg CEV • Press-fed CH4 • No radiation protection 	<ul style="list-style-type: none"> • 31m³ pressurized volume (LM = 6.7m³) • Press-fed CH4 ascent, pump-fed H2 descent & LOI 	55.6 t



Figure 4-46. Single Launch LOR Mission Performance

LSAM/CEV Constraints with Current Mission Requirements

The second single-launch option differs from the first in that, instead of retaining the CEV and LSAM configurations from the reference architecture while restricting surface access to near-equatorial lunar sites, it retains global surface access and anytime return while restricting CEV and LSAM size by reducing the crew size from four to two. As in the reference architecture, a 7-day surface stay time and 500-kg surface cargo delivery is still assumed. This provides an exploration capability comparable to the Apollo program in terms of number of crew on the surface while exceeding its capability in stay time and surface access. The longest Apollo mission, Apollo 17, lasted only 3 days on the surface, while the highest landing site latitude was 26.1°N for Apollo 15.

With the smaller crew size, the pressurized volume of the CEV and LSAM are reduced from 29 and 31 m³ to 22 and 15 m³, respectively. The 5.0-m diameter, 30-deg sidewall angle capsule shape from Design Cycle 1 is the assumed CEV shape in this single launch option. Reducing the crew size from four to two produces a trans-lunar injected mass of 55.1 t, compared to a 54.6 t capability with the LV. Again, this option was considered technically feasible according to this preliminary performance analysis while requiring a reduced margin on the LV for the 0.5 t shortfall.

4.2.5.3 Figures of Merit

4.2.5.3.1 Safety and Reliability

The same probabilistic techniques used in previous analysis cycles, and described in **Section 8, Risk and Reliability** were repeated for the final set of mission modes and technology options. Three mission modes were analyzed, with three different propulsion technologies applied. In addition to the LOR, EOR–LOR 2-launch, and EOR–LOR 1.5-launch modes, analysis was also performed on a single-launch mission that launched both the CEV and lander atop a single heavy-lift CaLV (the same used for the 1.5-launch solution), much like the Apollo/Saturn V configuration. However, the limited lift capability provided by this approach limited its utility, and it was not examined further. For each of the mission modes, end-to-end single-mission probabilities of LOC and LOM were calculated for (1) a baseline propulsive case using all pressure-fed LOX/methane engines, (2) a case where a LOX/hydrogen pump-fed engine was substituted on the lander descent stage, and (3) a third case where the lander ascent stage engine was changed to pump-fed LOX/methane. **Figures 4-47 and 4-48** illustrate the P(LOC) and P(LOM) for each of these cases.

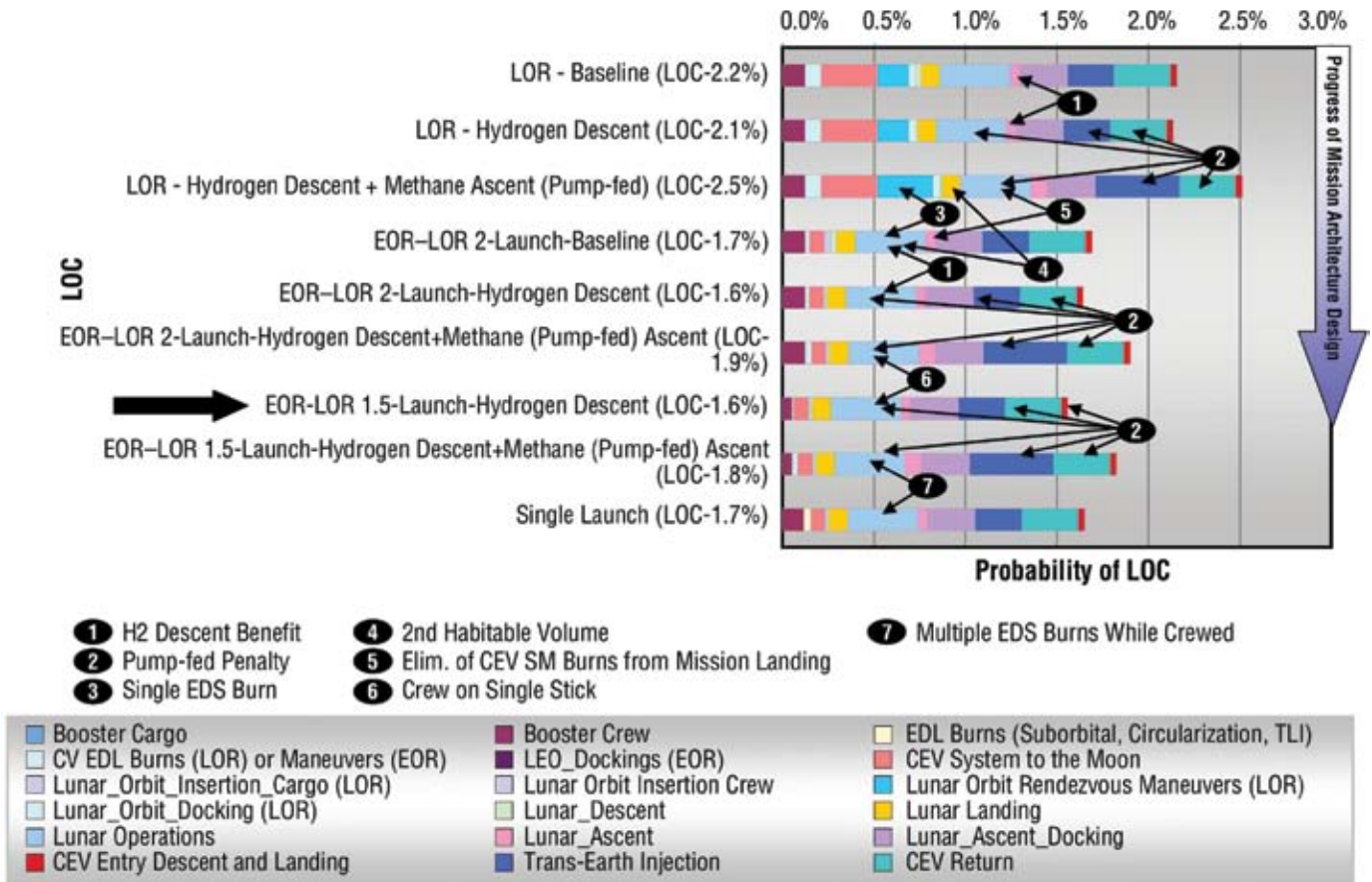

Figure 4-47. LOC Comparison

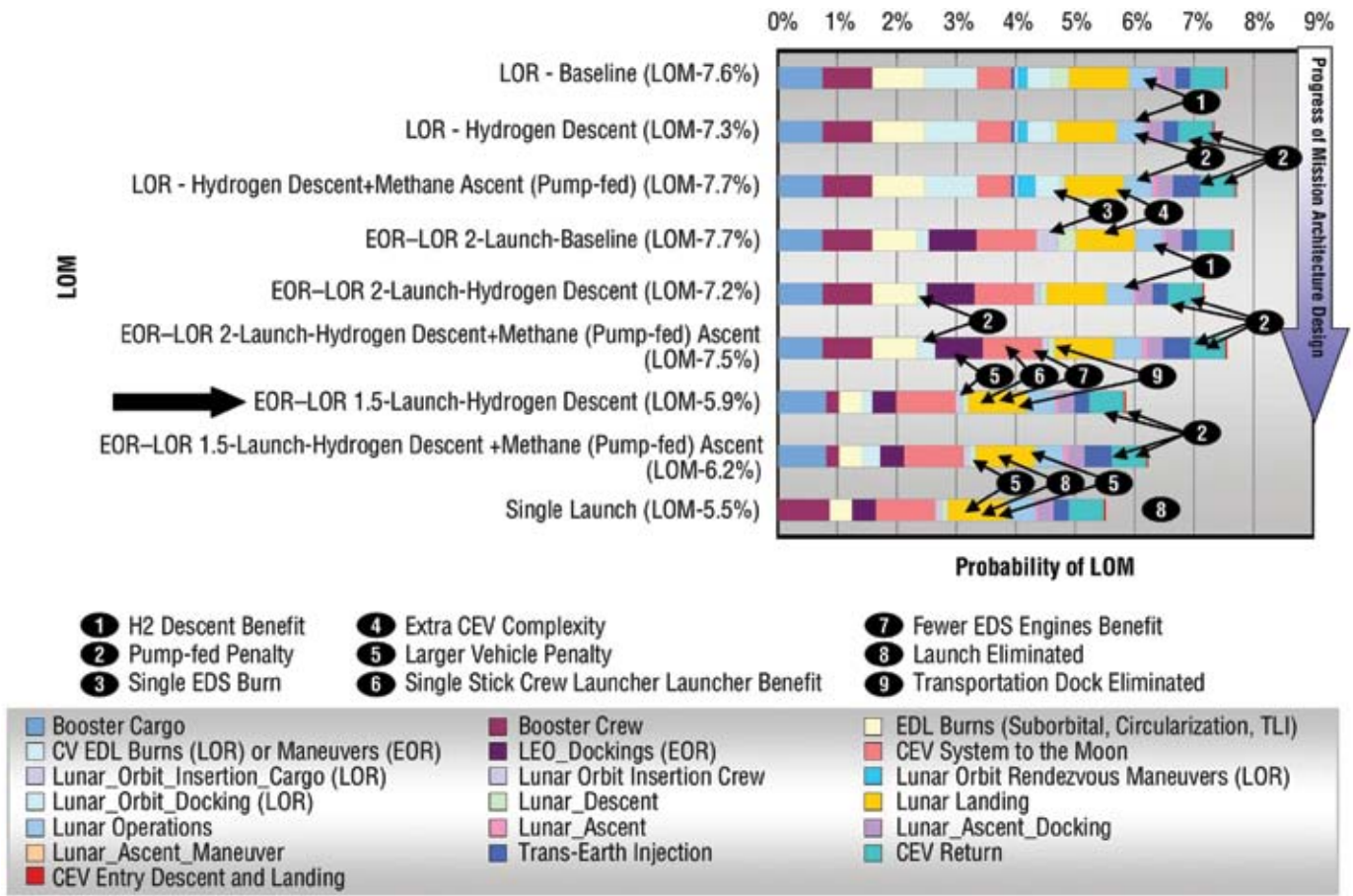

Figure 4-48. LOM Comparison

P(LOC) was dominated by propulsive events and vehicle operating lifetimes. As shown in **Figure 4-47**, LVs varied only slightly between the 2-launch (crew launched on a heavy-lift booster) and 1.5-launch (crew launched on a single SRB CLV) options. The LOR options had added risk due to the lander being sent to the lunar orbit separately from the CEV, and thus not having a back-up crew volume during transit to handle “Apollo 13”-like contingencies. The LOR mission also required the CEV SM to perform an LOI maneuver. Generally, each time a pump-fed engine technology was introduced to replace a pressure-fed system, risk increased, although the LOX/hydrogen engine modeled for the lander descent stage had a high degree of heritage from existing RL-10 engine technology.

When all the mission event probabilities were summed, all mission options fell within a relatively narrow range (1.6 to 2.5 percent), but the difference between the highest- and lowest-risk options approached a factor of two. Missions using the LOR mission mode were the highest risk options, while EOR-LOR 1.5-launch options were the lowest. Missions that utilized a higher-performing LOX/hydrogen lander descent stage scored approximately the same as the baseline option that used pressure-fed LOX/methane, but a change to a pump-fed LOX/methane ascent stage resulted in an appreciable increase in risk. The single-launch option, with its single LV, shorter propulsive segments, and limited surface access ability, was grouped with the lower LOC options. The lowest probability of LOC option was the 1.5-launch EOR-LOR mission using a pump-fed LOX/hydrogen lander descent stage and pressure-fed LOX/methane engines for both the lander ascent stage and CEV SM.

P(LOM) generally followed the same trends as P(LOC). **Figure 4-48** illustrates the reliability benefits of launching crew on the single-SRB CLV, the reduced risk of having a single EDS stage, and the penalties associated with pump-fed engines. LOR and EOR–LOR 2-launch options exhibited the greatest P(LOM), in a range between 7 and 8 percent per mission. The substitution of a LOX/hydrogen lander descent stage engine actually increased mission reliability by adding engine-out performance to the LOI and lunar landing phases of the mission, but further pushing LOX/methane engine technology toward a pump-fed system lowered reliability by eliminating commonality with the CEV SM engine and adding complexity.

The single-launch mission option scored the highest reliability overall, owing mainly to it requiring only a single launch. Of the missions that provide the full lunar landing site access and return capabilities, EOR–LOR 1.5-launch modes were nearly competitive with the single-launch option. Specifically, the EOR–LOR 1.5-launch option using the LOX/hydrogen lander descent stage engines scored the lowest P(LOM) among the full-up mission options. Interestingly, this same mission mode and propulsion technology combination scored the lowest P(LOC) as well.

4.2.5.3.2 Mission Mode Cost Comparison

Figure 4-49 summarizes the LCCs described in detail in **Section 12, Cost**. To enable a fair comparison among the options, the complete LCCs, including DDT&E, flight units, operations, technology development, robotic precursors, and facilities, were all included in this analysis. Generally, the choice of mission mode had only a small effect on the LCCs of the exploration program. Of the options modeled, the 1.5-launch EOR–LOR mission using a LOX/hydrogen lander descent stage propulsion system exhibited an LCC that was a few percent less than other options.

4.2.5.3.3 Other Figures of Merit

Analysis Cycle 3 focused primarily on the performance improvements possible for each of the three mission modes and the associated cost, safety, and reliability changes that accompanied these technology or design changes. Fundamentally, the mission modes themselves were not changed during this analysis cycle, so other FOMs such as flexibility, extensibility, effectiveness, performance, or operability did not change from those established in Analysis Cycle 2. For these FOMs, refer to **Tables 4-14** and **4-15** in **Section 4.2.4.3, Figures of Merit**.

4.2.5.4 Summary of Analysis Cycle 3 Mission Mode Results

Analysis Cycle 3 was structured to refine the fidelity of spacecraft system descriptions and mass models, investigate technology options that could optimize different modes, and produce performance, risk, and cost data that could be used in combination to recommend a preferred lunar architecture mission mode.

Refinement of the CEV mass model began with an improved understanding of radiation shielding requirements. Based on a revised spacecraft cross-section featuring a composite outer skin, probabilistic event and dose calculations were performed. Based on the short duration of the CEV lunar mission and the leveling of risks to the crew, the ESAS team recommended that the inherent design of the CEV could protect the crew to a degree commensurate with other mission risks and that no supplemental radiation protection was required for the CEV. The reduction of supplemental radiation protection created considerable spacecraft mass margin in each of the mission modes.

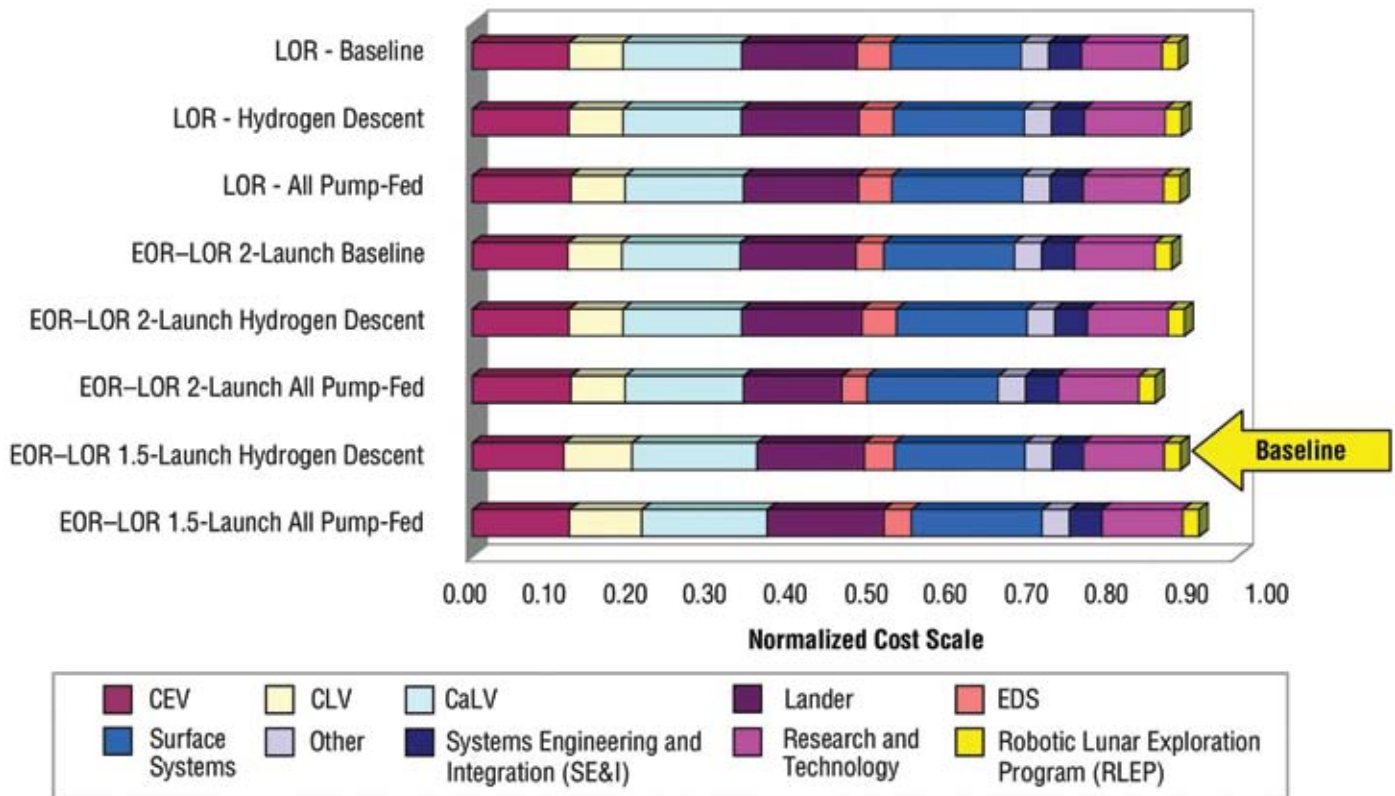

Figure 4-49. Mission Mode LCCs Through 2025

The requirement to return anytime from the surface of the Moon to Earth was the design driver of the SM propulsion system. The CEV SM is common across all of its missions and is sized by the lunar mission application. The lunar mission requires a total of 1,450 m/sec of delta-V, combining a 900 m/sec TEI maneuver and a worst-case 90-deg nodal plane change. This capability enables “anytime return” if the lander is able to perform a coplanar ascent to the CEV. For sortie duration missions of 7 days or less, the CEV’s orbital inclination and node will be chosen to enable “anytime return” from any location on the lunar surface. Outpost missions will also have the ability to return anytime the outpost is located at a polar or equatorial site. For other sites, loitering on the surface at the outpost for up to 14 days may be required to enable a coplanar ascent to the orbiting CEV.

Landing at any site on the Moon sizes the magnitude of the LOI maneuver. A nominal 900 m/sec LOI burn enables access to the equator and poles. Additional delta-V is required for nodal plane changes to access other sites up to a maximum of 1,313 m/sec for immediate access to any site on the lunar globe. Another technique that can be used to access any landing site is to loiter in orbit or to use a combination of nodal plane change and orbital loiter. The team ultimately chose the latter combination to balance additional propulsive requirements on the lander descent stage and additional loiter lifetime of the CEV systems. The lander descent stage was sized for a 900 m/sec LOI plus a 200 m/sec maximum nodal plane change, for a total of 1,100 m/sec in addition to lunar descent propulsion. This value allows the system to immediately access all but a small percentage of lunar surface, and those high-latitude, limb sites are accessible with no more than 3 days of post-LOI loiter prior to descent. Limiting LOI to 1,100 m/sec establishes comfortable mass margins for all mission modes.

LOM and LOC probabilities were assessed for each of the mission modes, and P(LOM) and P(LOC) were generated within the mission modes for three discrete lander propulsion options. Of the options studied, the EOR–LOR mode yielded both the lowest P(LOM) and the lowest P(LOC) when flown with a LOX/hydrogen lander descent stage and common pressure-fed LOX/methane propulsion system for both the lander ascent stage and CEV SM. Cost analysis was less definitive, but also showed this same EOR–LOR 1.5-launch option having the lowest cost of all the alternatives studied.

Based on the convergence of robust technical performance, low P(LOC), low P(LOM), and LCCs, the 1.5-launch EOR–LOR using LOX/hydrogen lander descent stage propulsion was selected as the mission mode to return crews to the Moon.

4.2.5.5 Architecture Findings and Recommendations

Based on the analyses performed by the ESAS team, a comprehensive evolutionary architecture was constructed that can successfully perform near-term ISS crew and cargo delivery missions, human missions to the lunar surface, and farther-term human missions to Mars and beyond. The key features that enable the architecture to evolve over time are the design of the CEV, the choice of CLV and CaLV, the selection of technologies (particularly propulsion technologies), and the operations procedures and systems that extend across the destinations. Architecture linkages are shown in **Figure 4-50**.

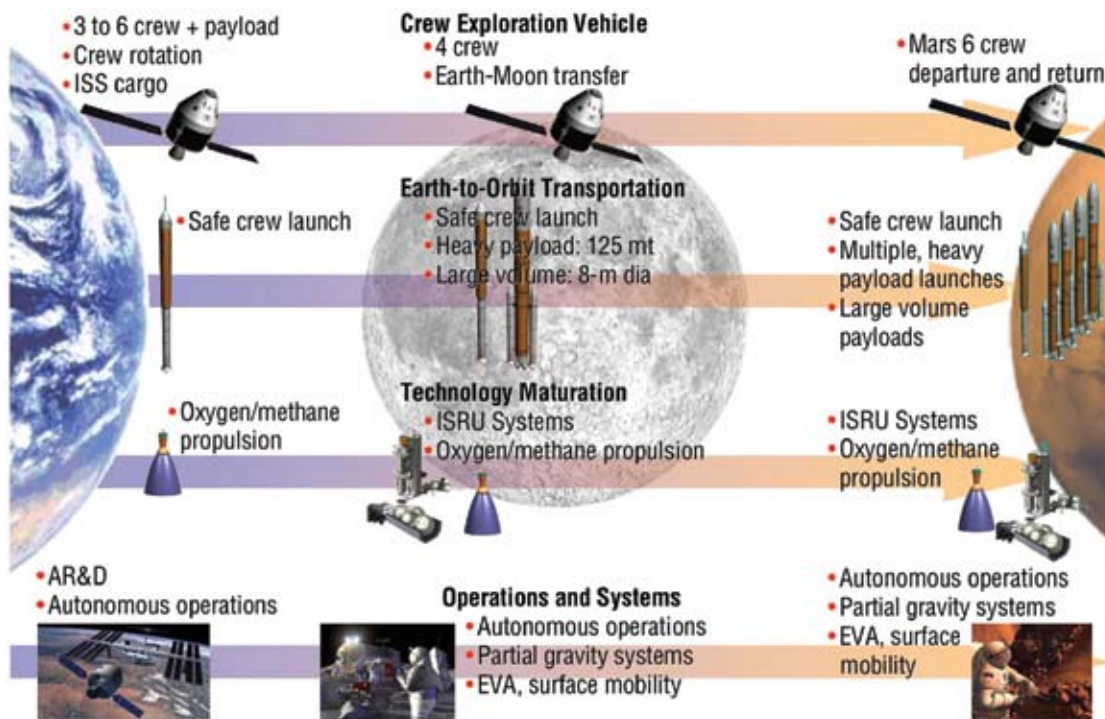

Figure 4-50. ISS → Moon → Mars Architecture Linkages

The CEV CM was selected to be a 5.5-m diameter blunt-body capsule with a 32.5-deg side-wall angle to retain maximum commonality with Apollo aerothermal databases. The CEV SM will use pressure-fed LOX/methane propulsion that will be common with the lunar lander ascent stage propulsion. The SM will be common for all CEV missions and will be sized for lunar mission TEI (1,450 m/sec delta-V).

The CLV will be derived primarily from components of the Space Shuttle system. The first stage of the CLV will use a four-segment, RSRB. The second stage will be a new design based on a single Space Shuttle Main Engine (SSME), modified for altitude start. The CEV will be fitted with a Launch Escape System (LES) that will provide full-envelope abort capability.

The CaLV will also be based on Shuttle-derived components. It will use twin five-segment RSRBs on either side of an External Tank- (ET-) derived core. The core stage will be powered by five SSME Block II engines. Atop the core stage is an upper stage that burns suborbitally during launch and then serves as the EDS for injecting the CEV and lander to the Moon. The EDS is powered by two J-2S, or equivalent, LOX/hydrogen engines.

The lunar mission will be conducted using a combination of EOR-LOR. A single launch of the CaLV will place the lunar lander and EDS in Earth orbit. The launch of a CLV will follow and place the CEV and crew in Earth orbit, where the CEV and lander/EDS will rendezvous. The combination of the large cargo launch and the single SRM CLV is termed a 1.5-launch EOR-LOR mission. The EDS will then inject the stack on a trans-lunar trajectory and be expended. The lander and CEV are captured into lunar orbit by the descent stage of the two-stage lander, and all four crew members descend to the surface, leaving the CEV operating autonomously in orbit. The two-stage lander uses LOX/hydrogen propulsion for its descent stage and pressure-fed LOX/methane propulsion for ascent. The lander features an airlock and the capability to support up to a 7-day surface sortie. Following the lunar surface mission, the lander's ascent stage returns to lunar orbit and docks with the waiting CEV. The crew transfers back to the CEV and departs the Moon using the CEV SM propulsion system. The CEV then performs a direct-Earth-entry and parachutes to a land landing on the west coast of the United States. The mission is illustrated schematically in **Figure 4-51**.

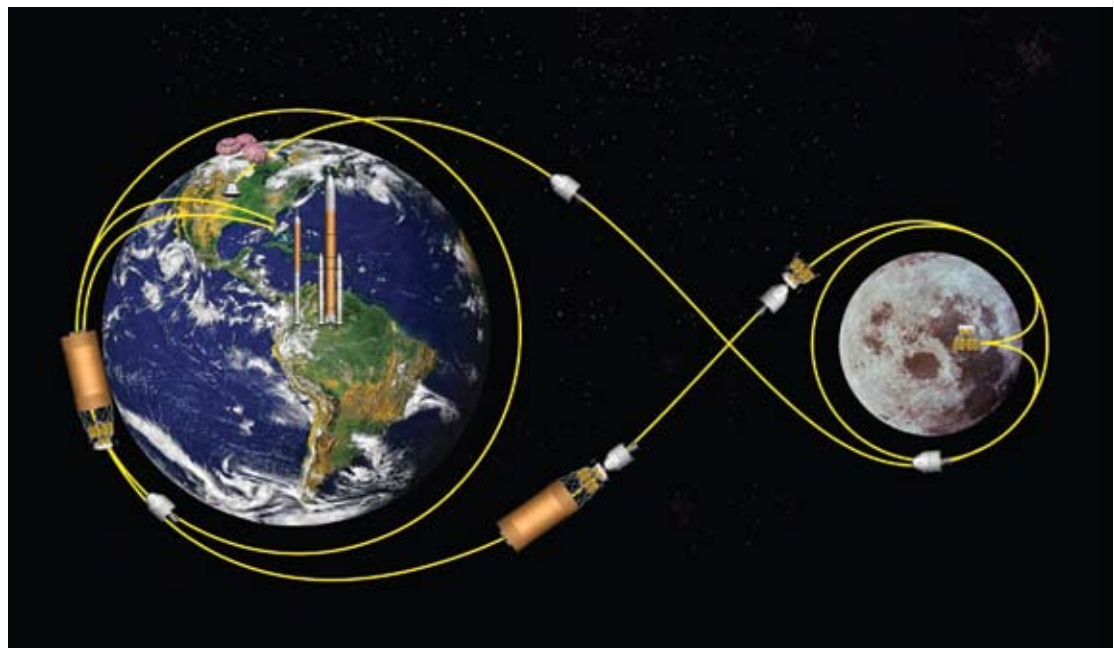

*Figure 4-51. EOR-LOR
"1.5-launch" Lunar
Mission Architecture*

4.3 Lunar Surface Activities

In the space mission design process, it is imperative to define the destination activities in order to design the systems necessary to allow those activities to occur. On January 14, 2004, the President provided a strategic vision of space exploration beyond Earth orbit, emphasizing the importance of using the Moon's natural resources to establish an extended human presence on the lunar surface and using the time spent on the surface to develop and test new approaches, technologies, and systems that will allow the further exploration of Mars and other destinations in the solar system. Gaining a better understanding of the Moon and its environment is critical to successfully accomplishing the President's goals. Appropriately, the ESAS team chose to focus lunar surface activities on (1) exploration science, (2) development of lunar resources, and (3) Mars-forward testing of operational techniques and surface system technologies.

4.3.1 Exploration Science

Human return to the Moon both enables and is enabled by science. Gaining a better understanding of the Moon and its environment requires science to be an integral part of the lunar architecture. Moreover, by virtue of the destinations and voyages outlined by the exploration vision, opportunities exist for new and exciting scientific exploration. The return to the Moon enables the study of the Moon as a planetary object, the use of the Moon as a platform for unique scientific observations, and the study of biological systems in an isolated fractional-gravity environment.

Scientific themes for lunar exploration have been developed by the NASA-chartered Lunar Exploration and Analysis Group (LEAG) (**Appendix 4D**). These scientific investigations can be integrated into every phase of the lunar return architecture, including precursor robotic missions, human sorties, and outpost operations. In fact, these phases will be informed and enabled by the scientific investigations undertaken.

Exploration science can be broadly divided into three categories: (1) planetary science of the Moon and Earth-Moon system, (2) use of the Moon and its environment as an observing platform and natural laboratory, and (3) applied science of resource extraction and outpost engineering.

Planetary science uses the natural history recorded in the lunar surface and crust to understand planetary geological processes such as impact, volcanism, and thermal history. For example, **Figure 4-52** shows a lunar crew acquiring subsurface samples near the center of a small complex crater through the use of deep drilling equipment to better understand the geologic process of impact cratering. The Moon contains a record of active planetary events between 4.6 and 3 billion years ago. Since then, the Moon has recorded the impact flux in the vicinity of the Earth—a record that can be recovered and read for clues to the impact disruption of the Earth's climate and life suggested from the fragmentary and incomplete terrestrial record. The Moon is also a natural laboratory for processes (especially biological) that may operate differently in a vacuum, fractional gravity, and non-radiation shielded environment. Studies of cell growth and evolution in 1/6 gravity may yield new insights into biological processes in general. An understanding of the long-term effects of space and planetary environments on human physiology and psychology is necessary in order to explore beyond the Moon.

Figure 4-52. Lunar Crew Acquiring Subsurface Samples



The Moon also offers a superb and unique platform to observe the Earth, solar system, and universe at a variety of wavelengths and viewing conditions. The Moon's quiet stable base permits construction of sensitive systems of instruments such as interferometers, and the far side offers a place shielded from interference of the Earth and (occasionally) the Sun. This unique environment permits otherwise unobtainable observations.

One of the key features of the exploration vision is the use of lunar and space resources to create new capability. Science is essential to this endeavor. NASA needs to understand the distribution and state of lunar resources to enable their harvesting and use. Achieving this understanding involves mapping the deposits from orbit, examining and surveying them on the ground, and experimenting with various processes and procedures for their extraction. Robotic precursor missions will investigate the polar regions to map volatiles in the permanently shadowed areas and determine the environment of the poles to identify optimum potential outpost sites. Mining sites must be assayed and prospected to determine the best feedstock locations, and various resource extraction processes must be evaluated to optimize production. The scientific investigations that support these activities will also reveal new aspects of the Moon, thus advancing lunar science as well as supporting the human activities. For these reasons, scientific measurements must be considered during each phase of the human lunar return.

4.3.2 Scientific Themes for Human Lunar Return

These themes include the following:

- Bombardment of the Earth-Moon system:
 - Measure the recorded bombardment history of the inner Solar System;
 - Understand the duration and intensity of “late-heavy bombardment” of early Earth and other planets; and
 - Understand the episodicity of later impactor flux and impactor-induced mass extinctions.
- Lunar processes and history:
 - Determine the composition and structure of the interior of the Moon to understand lunar origin and evolution.
- Scientific resources in the permanently shadowed polar environment:
 - Investigate the unexplored shadowed environment (unlike the equatorial Moon) which is similar to conditions in interstellar space and Oort cloud (silicate grains, cosmic rays Ultra-Violet (UV) radiation, and temperature fluctuations); and

- Utilize the polar environment as a natural laboratory for understanding environments not otherwise accessible.
- Regolith as a recorder of the Sun’s history:
 - Read the 4-billion year record of the sun and galaxy recorded in the lunar regolith; and
 - Investigate the Apollo data that hints at nuclear processes in the Sun not predicted by current models of stellar evolution.
- Biomedicine:
 - Determine fundamental mechanisms causing genomic damage;
 - Establish synergy between lunar expedition and terrestrial biomedical advances; and
 - Develop novel approaches to study and address Earth-based pathogenesis and environmental health hazards.
- Using the Moon’s resources:
 - Develop fundamental advances in science associated with resource extraction; and
 - Enhance human exploration capabilities on the Moon, cislunar space, and beyond.
- Astronomy:
 - Observe ultra-deep field; observe first stars to form in the universe beyond the capabilities of the James Webb Space Telescope (JWST); and
 - Utilize the lunar far side; low-frequency radio astronomy opens up new wavelength range.

4.3.3 Lunar Resource Development

Learning how to use the resources of space (materials and energy) is a key feature of the exploration vision. Incorporating the use of these resources into space exploration architectures will make space flight more affordable and expansive. The Moon contains known resources, particularly oxygen and hydrogen, that can be harvested and used. Producing fuel and life-support materials on the Moon will permit the lunar outpost to achieve some measure of self-sufficiency. The skills needed to use these resources will be indispensable as humans travel beyond the Earth-Moon system.

Lunar resources can be classified into three broad categories: (1) materials requiring minimal processing, (2) materials requiring some processing, and (3) energy. In the case of the former, bulk regolith (i.e., the soil that blankets the lunar surface) is a significant resource. It can be used to provide building materials and radiation cover for habitats on the Moon. Regolith can be microwaved into glass, a technique useful for creating pavement for roads and landing areas. Regolith can also be bulldozed into berms to provide blast shielding for landing pads and protect sensitive instruments from flying dust created by human and machine activity. Experiments must be conducted using this bulk regolith to determine its geotechnical properties and ease of handling. However, the regolith is also abrasive and must be studied to learn strategies to mitigate its possible harmful effects to moving machine parts and human ingestion.

Lunar regolith can also be processed to yield a variety of products, the most important of which is oxygen, which makes up at least 40 percent (by weight) of the lunar soil. Although tightly bound chemically, this oxygen can be broken by a variety of chemical reduction processes. Early flight experiments can prove and demonstrate some of these techniques and allow for selection of one technique for general oxygen production. As oxygen is 80 percent of the mass of LOX/hydrogen propulsion systems, the production of lunar LOX would significantly benefit Earth-Moon transportation. Moreover, hydrogen is also present in the lunar regolith as absorbed solar wind gas on the grains of the regolith. This hydrogen can be released if the soil is heated to 700°C. Production of hydrogen by this method implies a significant effort, as such hydrogen is present at very low levels of concentration (roughly 50–100 ppm in the richest deposits).

As a result of robotic missions flown in the 1990s, NASA discovered that the poles of the Moon may contain concentrated amounts of water ice. Confirmation of these deposits, however, awaits the flight of the next round of U.S. and international lunar robotic explorers that will make detailed measurements of the polar environment and deposits. If water ice can be found at the poles in useable quantities, mission flexibility could increase dramatically. Water ice is the most concentrated form of hydrogen and oxygen, and its recovery requires two orders of magnitude less energy than that required to extract the solar wind hydrogen from normal regolith. (See **Table 4-26**.) Thus, in the robotic precursor mission series, emphasis should be placed on early surveys of the poles to confirm or negate the existence of water ice. If water ice is present, a robotic mission should land near the poles and explore these areas in detail on the ground to confirm its presence and characterize the deposits. After such mapping, it will be necessary to experiment with techniques to extract the water ice from the regolith. Such demonstration experiments can be relatively small-scale and conducted on landed robotic missions prior to human arrival. If successful, larger-scale production could proceed at a lunar outpost. (See **Figure 4-53**.)

After the processes described above have been established, consideration should be given to a variety of derived products, including: the metals iron and aluminum (byproducts of oxygen reduction), carbon, nitrogen and sulfur (byproducts of regolith heating), anhydrous glass, and other metals and substances (including platinum group metals and meteoritic components). However, the recovery of these materials should only be considered after the establishment of processes to extract the most important resources.

Energy is abundant at the Moon in the form of incident solar radiation. For most of the Moon, this illumination follows a 28-day diurnal cycle. However, locations that are illuminated for much longer periods of time have been found near the poles (possibly permanently near the north pole). These areas are on the order of a few hundred meters to several kilometers in extent, and solar arrays set up in these zones could provide most of the power required by a lunar outpost. Moreover, such areas always receive grazing incidence angle illumination, making them thermally benign and of nearly constant temperature (approximately 50°C ± 10°C). Particular attention should be paid early in the robotic precursor missions to characterizing these areas and documenting their physical and thermal properties.

Operation	Specific Energy
Excavation of regolith	.01 kWh/kg regolith (electric)
Extraction of water from icy regolith*	2.8 kWh/kg H2O (thermal)
Reduction of SiO2 to Si + O2	5.2 kWh/kg SiO2 (electric)
Electrolysis of water	4.5 kWh/kg H2O (electric)
Extraction of hydrogen from typical regolith**	2,250 kWh/kg H2 (thermal) (~250 kWh/kg H2O)

Table 4-26. Lunar Resource Extraction Energy Requirements

*Assumes 1% ice, heated 100°C above ambient

**Assumes 100 ppm H2, heated 800°C above ambient



Figure 4-53. Lunar Crew at a Permanently Shadowed Crater Near the Lunar South Pole

4.3.4 Mars-forward Testing

Although the Moon and Mars are two very different planetary environments, the operational techniques and exploration systems needed to work and live on both surfaces will have similar strategies and functions. While it is not likely that exact “copies” of Mars-bound systems will be operated or tested on the Moon, it is very likely that components and technologies within those systems ultimately destined for the surface of Mars will undoubtedly find their heritage based on lunar surface operations. Therefore, the philosophy is to do what is proper and required for the lunar environment and use the knowledge, experience, and confidence gained from lunar operations as the foundation for the design of surface systems for Mars and other destinations in the solar system.

Two important operational techniques that should be developed on the Moon are crew-centered control of surface activities and teleoperation of robotic explorers from a central planetary outpost. Mars is very distant from the Earth-Moon system, and due to the speed of light, one-way communications with Mars can take up to approximately 20 minutes. Communications with a human crew on Mars will be hindered by this time delay, and the crew will need to be able to operate in an autonomous mode without constant supervision from Earth. As this is different from the way human space missions have been conducted to-date, the Moon will provide the opportunity to transition from Earth-centered to crew-centered control of daily operations. Likewise, the Mars Exploration Rover (MER) missions, though very successful, have shown the limitations of controlling robotic explorers on Mars from the Earth. Mars and the Moon are too big for a small human crew to explore effectively by themselves, and robotic systems teleoperated by the crew can be used to increase the efficiency of surface activities. Operations on the Moon will develop the synergism of cooperative activity between humans and robots that can be used on planetary surfaces throughout the solar system.

Regardless of which planetary surface human crews are living and working on, similar supporting infrastructure will be necessary. Habitation, power generation, surface mobility (i.e., space suits and roving vehicles), surface communication and navigation, dust mitigation, and planetary protection systems are all common features that will first be provided on the Moon. Repetitive and long-term use of these systems at a lunar outpost will allow the design of these systems and their components to be refined and improved in reliability and maintainability—system traits that will be essential for the exploration of destinations much more distant from Earth. The presence of an atmosphere and a stronger gravitational field on Mars, however, will require modifications to some components of the planetary surface systems used on the Moon, particularly those systems that directly contact the Martian surface or atmosphere. Lunar surface systems that are internal to a pressurized environment, such as a habitat’s regenerative life support system, are more likely to be directly applicable to Mars with fewer or no modifications.

4.3.5 Lunar Surface Traffic Model

Lunar architecture capabilities are driven in large part by the duration, location, and centralization of lunar surface activities. The magnitude of surface activities can be represented linearly, coarsely corresponding to a range of “simple” to “complex.” The continuum adopted by the ESAS team is shown in **Figure 4-54**. This graphical scale was used to illustrate a multitude of variables and to indicate the design points chosen for the study. The variables represented by this scale include the following:

- Number of sites to be visited (1 → many);
- Location of these sites (constrained latitude/longitude bands → global access);
- Duration of surface activities (approximate week-long sorties → permanently inhabited outpost);
- Centralization of assets (Apollo-class sorties with local mobility → mobile camp with predeployed logistics caches → single outpost w/ regional mobility); and
- Required infrastructure (power, communication, habitation, mobility, resource utilization, and science).

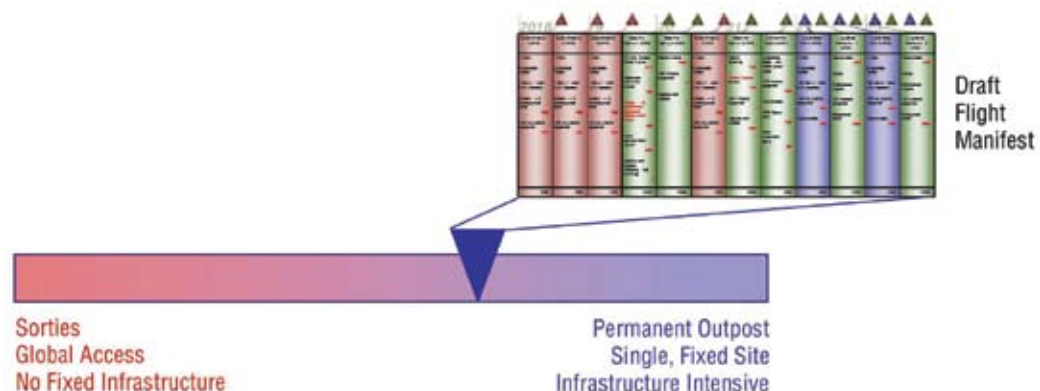

Figure 4-54. Lunar Surface Continuum

An initial strategy was chosen that starts with global-access, short-duration sortie missions beginning in 2018 and transitions quickly to deployment of a permanent outpost that is at an IOC by 2022. This strategy was chosen to enable early missions to test transportation systems and to allow short scientific sorties to a small number of diverse sites and extended development time lines for high-cost outpost systems. It was recognized that this initial strategy was a singular point in the multidimensional duration/location/centralization trade space and would later be modified as cost, risk, and performance of the system was better understood.

The location of the triangle in **Figure 4-54** represents the initial outpost deployment strategy discussed in **Section 4.2.5.1.4, Outpost Deployment Strategies**, which is defined by large, dedicated cargo missions that deploy an outpost in a small number of missions. The second deployment option discussed in **Section 4.2.5.1.4, Outpost Deployment Strategies**, would plot as another discreet pointer in **Figure 4-54**. This second point along the continuum would represent an outpost deployment strategy that has a greater reliance on sortie missions, but which would also be focused toward a single, revisited site. **Figure 4-54** graphically illustrates that lunar exploration, including the deployment of a lunar outpost, can be accomplished in a great number of ways.

This study has thus far discussed two points on the outpost deployment continuum: (1) dedicated large cargo missions and (2) incremental build using subsequent sortie missions. The ESAS team concluded that other points along the surface activity continuum should be analyzed as well. The initial results of this additional analysis are presented in **Section 4.2.5.1.4, Outpost Deployment Strategies**, and **Section 4.3.8, Outpost Deployment Studies**. Options can be found in **Appendix 4F, Alternate Outpost Deployment Options**.

4.3.6 Landing Sites

Depending on the principal purpose of the mission, there are many possibilities for landing sites on the Moon. Previous studies on future landing sites have emphasized their value to lunar science or for some specialized purpose (e.g., far side telescope installations). The ESAS team considered the many potential requirements for lunar landing site selection and compiled a list of sites on the Moon that illustrates the diversity of scientific and resource opportunities, geographic position, operational considerations, and usefulness. A roster of sites was compiled to explore the various trade spaces needed to understand architectural requirements.

4.3.6.1 Site Selection Consideration

Sites for human missions to the Moon may be selected on the basis of operational, scientific, resource potential, and programmatic considerations. In general, sites that offer many different features to a wide variety of interests are preferred. The more geological diversity a site offers for science, the more attractive it is for exploration. For the extraction of resources, the highest grade “ore bodies” are desired to maximize the product for the minimal investment of time and energy. Fortunately, the Moon is diverse and complicated enough on the scales of human operations that many sites exist that satisfy the requirements of many different and diverse users.

The idea that water ice may exist at the poles of the Moon has gained currency in the last decade as a result of two robotic missions (Clementine and Lunar Prospector) that found evidence for enhanced volatile concentrations associated with the poles. If such water ice exists, the extraction of water from this lunar resource requires at least two orders of magnitude less energy than does the synthesis of water from the hydrogen autoreduction of solar wind gas-saturated regolith. Thus, the polar deposits qualify as “high-grade ore.” Moreover, there is evidence that certain small areas near the poles may be in near-constant sunlight, providing sites that have access to continuous solar power and are also thermally benign.

Ten sites have been selected as examples to explore the ramifications of the site selection trade space. Listing these sites should in no way be construed as an advocacy or an endorsement of any given site as the “favored” site for the lunar outpost. At an appropriate time, NASA will create a process designed to obtain the best possible information on the requirements and needs of the various lunar mission stakeholders in order to pick a landing site that satisfies the most user requirements.

4.3.6.2 Classification of Landing Sites

While sites on the Moon may be classified in a variety of ways, sites were categorized by position (e.g., equatorial, mid-latitude, limb, and polar) for the purpose of the ESAS work to understand the operational difficulties of accessing them and by the similarity or dissimilarity to previously visited Apollo sites (to assess requirements for precursor site knowledge). Ten sites that span the range of these properties were identified, all of which offer significant scientific and operational features that make them worthy of consideration for both sortie and outpost missions to the Moon. (See **Figure 4-55**.)

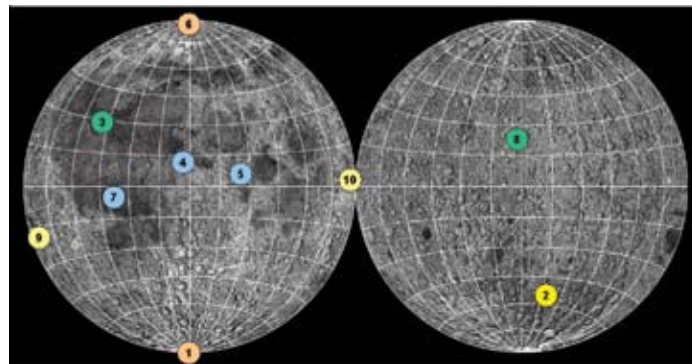

Figure 4-55. Lunar Sites Selected to Explore Architectural Trades

The equatorial sites selected (defined here as those within 30 deg of the equator) are, with one exception, on the near side. They are similar enough in geological age, setting, and physical properties that they can safely be assumed to be very similar to the sites visited by Apollo. This means that surface dust, slope and block distribution, gross topography, and other properties are already fairly well known, at least to the level of being able to successfully plan and conduct a human surface mission. Thus, no robotic precursor missions are required before human visits to such sites. (See **Table 4-27**.)

Sites	Navigation/ Communication	Precision Topogra- phy and Local Terrain	Surface Deposit Characterization	Site Environment
Equatorial and low latitude sites	No	Probably not	No	No
Limb sites	Yes	Yes	No	No
Polar sites	Yes	Yes	Yes	Yes

Table 4-27.
Classification of
Required Precursor
Information as a
Function of Site
Geographical Position

Sites on the eastern and western limbs of the Moon are likewise equatorial and anticipated to have surface physical characteristics similar to previously visited Apollo sites. However, their location on the lunar limbs indicates that these sites have Earth visibility issues due to the longitudinal libration of the Moon. Although these sites can be grossly modeled, detailed information on the exact times and durations of Earth visibility requires detailed site topographic information (data that does not currently exist). Thus, these sites require the acquisition of new, high-resolution topographic data. Such data should be acquired by the forthcoming Lunar Reconnaissance Orbiter (LRO) mission.

Sites on the far side require a relay infrastructure to ensure adequate communications with the Earth, but are otherwise assumed to be similar in physical properties to near-side sites. An exception to this is the absence of Earth light, which is a significant resource for possible night operations on the lunar near side. A single site (South Pole-Aitken basin) is at high latitudes. This site is included not only for its scientific value (e.g., a site on the oldest basin terrain on the Moon), but also to explore the operational trade space of the mission mode decision.

The poles of the Moon are a unique environment. Because the lunar spin axis is essentially normal to the ecliptic (axial tilt 1.7 deg), the Sun is always near the horizon at the poles. This simple relation has profound consequences—not only does it create the permanently shadowed cold traps that may contain water ice, but high peaks and terrain elements near the poles may be in near-constant solar illumination. Analysis of Clementine images show zones of potential continuous light at the lunar north pole and several areas of near-constant illumination (greater than 75 percent of day) near the lunar south pole. Such areas have great value for an outpost site. Not only do they provide a place of near-constant solar illumination (allowing for reliance on solar-voltaic power systems), they are also thermally benign (typically, approximately $-50^{\circ}\text{C} \pm 10^{\circ}\text{C}$) due to the illumination always occurring at grazing angles of incidence. These properties, in addition to their proximity to cold areas containing water ice, make the poles attractive landing site candidates.

However, knowledge of the environment and deposits of the polar regions is extremely limited. The true extent of both lit and dark regions is not known. Temperature estimates of the cold traps are modeled, not observed. The physical and chemical nature of polar volatiles and the regolith containing them, as well as their detailed distribution and state, are unknown. This information must be collected prior to human arrival if use of the unique polar attributes is to be a major mission goal. Thus, the polar sites require the most robotic precursor information (**Table 4-27**), including mapping these relatively unknown areas in detail and characterizing the polar environment and their deposits. A further discussion of precursors to human lunar missions is presented in **Appendix 4I, Lunar Robotic Precursor Missions**.

4.3.6.3 Brief Description of the Sample Landing Sites

The following section briefly notes the characteristics, advantages, and drawbacks of the landing sites identified in this study.

- South pole (rim of Shackleton, 89.9°S, 180°W): This area of near-permanent sunlight on the rim provides access to power and proximity to a cold trap (crater interior) that may contain water ice. The site is on the floor of the South Pole-Aitken (SPA) basin, the oldest and biggest impact feature on the Moon. The southern celestial hemisphere is continuously visible.
- SPA basin floor (near Bose, 54°S, 162°W): This site is on the floor of the SPA basin, which possibly exposes the lower crust or upper mantle of the Moon. The site is on the far side of the Moon, out of Earth view, and would require a communications relay system for Earth contact. Observation of the low-frequency radio sky would be possible here.
- Aristarchus Plateau (north of Cobra Head, 26°N, 49°W): This is a diverse site containing unusual rock types, ancient crust, Imbrium basin ejecta, non-mare volcanism, and extensive dark mantling (pyroclastic) deposits. The dark mantle may be good feedstock for ISRU processing (e.g., solar wind hydrogen). There is easy and routine access to this near-equatorial, near-side site.
- Rima Bode (near Vent, 13°N, 3.9°W): There are extensive regional high-Ti dark mantle deposits at this site. The vent system for these ash deposits may contain xenoliths (exotic chunks) of rock from the deep mantle of the Moon. Existing data suggest high-Ti pyroclastic glass may be excellent feedstock for ISRU processing. There is easy and routine access to this near-equatorial, near-side site.
- Mare Tranquillitatis (north of Arago, 8°N, 21°E): High-Ti maria near the landing site for the Apollo 11 mission in 1969. High-Ti basalts are excellent feedstock for ISRU processing. Smooth maria is physically well-characterized and already covered by extensive, high-resolution photography (from the lunar orbiter). There is easy and routine access to this near-equatorial, near-side site.
- North pole (rim of Peary B, 89.5°N, 91°E): This area of near-permanent sunlight on the rim provides access to power and proximity to a cold trap (crater interior) that may contain water ice. The site is on the distal edges of the Imbrium basin ejecta blanket. The northern celestial hemisphere is continuously visible.
- Oceanus Procellarum (inside Flamsteed P, 3°S, 43°W): This mare site is on the western near side. Basalts here appear to be some of the youngest lavas on the Moon, possibly as young as 1 billion years. High-Ti lavas provide excellent feedstock for ISRU processing. There is easy and routine access to this near-equatorial, near-side site.
- Central far side highlands (near Dante, 26°N, 178°E): This highland site is on the central far side of the Moon. The site appears to be on the most ancient, primordial crust of the Moon—the original magma ocean anorthosites. There is Al- and Ca-rich regolith available for ISRU processing. Observation of the low-frequency radio sky would be possible here. This site would require relay satellites for Earth communications.
- Orientale basin floor (near Kopff, 19°S, 88°W): This is a combination highland/mare site on the floor of the youngest major basin on the Moon. Crater Kopff has unusual morphology and may be an endogenically modified impact crater. This site contains both mare and highland regolith feedstock for ISRU processing. The limb site is sometimes out of view of Earth and would require a relay for continuous communications.

- Smythii basin floor (near Peek, 2.5°N, 86.5°E): This mare site is on the floor of the ancient Smythii basin on the eastern limb of the Moon. Mare basalts here are very young (approximately 1–2 billion years) and could be used to study lunar thermal history. This site contains high-Fe mare regolith feedstock for ISRU processing. The limb site is sometimes out of view of Earth and would require a relay for continuous communications.

4.3.7 Sortie Mission Surface Activities

As part of the ESAS effort, a lunar sortie crew DRM was developed to describe the types of activities that will occur on the lunar surface during the initial demonstrations of human exploration beyond Earth orbit. The goals of these short-duration missions are to:

- Conduct scientific investigations using the Moon as a natural laboratory to better understand planetary processes such as impact cratering and volcanism and to understand the integrated effects of low gravity, radiation, and the planetary environment on the human body;
- Conduct ISRU demonstrations, such as regolith excavation, manipulation, and processing; and
- Conduct Mars-forward testing of operational techniques and systems, including field exploration techniques, EVA systems (i.e., space suits, portable life support systems, and surface mobility systems), and dust mitigation and planetary protection approaches.

The guidelines and assumptions used in the development of the lunar sortie crew mission DRM were:

- A crew size of four on the lunar surface with all crew members simultaneously conducting EVAs;
- Surface mission durations of up to 7 days;
- The capability to land anywhere on the Moon;
- Sortie missions directed toward scientifically interesting sites;
- The crew living and working out of their landed LSAM; and
- No predeployed surface assets required to perform a sortie mission.

4.3.7.1 Surface Mission Description

Surface activities on lunar sortie crew missions will be similar to those on the final Apollo J-missions (i.e., Apollo 15, 16, and 17). The emphasis will be on EVAs, where all four crew members don space suits and simultaneously conduct operations on the lunar surface outside of their landed spacecraft. An airlock on the LSAM would allow sick, injured, or fatigued crew members to remain inside the pressurized LSAM while others are conducting EVAs. The crew's activities will focus on exploration science and field work, the deployment and emplacement of long-term scientific experiments, equipment and robotic systems, technology demonstrations of ISRU techniques, and the emplacement of surface infrastructure such as power, communication, and navigation systems to support continuing activities once the crew leaves.

Surface missions lasting 4 days will have EVAs each day. The first (landing) and last (take-off) days will likely have shorter duration EVAs of 4–6 hours, while the middle two days will each have a full 6- to 8-hour EVA period. Longer-duration sortie missions of up to 7 days would likely require at least 1 day of rest without planned EVAs. The crew will mostly work as two separate EVA teams (with each team consisting of two people), although all four crew members could work together on large and/or complex tasks.

While inside the spacecraft, the crew will perform all of the routine aspects of eating, sleeping, resting, and personal hygiene. Intra-Vehicular Activity (IVA) will also include preparing and maintaining EVA space suits, planning for subsequent operations on the lunar surface, and all activities associated with post-landing and prelaunch operations.

Due to the short-duration of lunar sortie crew missions, surface operations would initially be conducted in a fairly traditional manner similar to the Apollo missions. However, as experience is gained or discoveries are made, flexible and evolvable mission operations should replace scripted timelines, with the surface crew allowed some level of autonomy in decision making.

One of the lessons learned from the Apollo missions was that mobility is key to efficient exploration of the lunar surface. The Apollo Lunar Roving Vehicle (LRV) allowed the Apollo 15, 16, and 17 astronauts to travel farther from the LM, observe a more diverse set of terrain features, and collect a greater variety of samples than the previous Apollo missions that were restricted to foot travel only. Surface mobility systems, such as the LRV, will be needed on future sortie missions to allow all crew members to efficiently explore the local area within 15–20 km of their lander. To accommodate the four-person crews, two roving vehicles, each capable of carrying either two people plus payload or four people total, were chosen for this DRM. Alternative combinations of systems could include one roving vehicle plus two single-person mobility systems—similar in function to four-wheel All Terrain Vehicles (ATVs) common on Earth—or four single-person ATVs (one for each crew member). A detailed surface traffic assessment was not conducted for the ESAS.

Some surface assets emplaced on the lunar surface would continue to operate after the crew leaves. Scientific monitoring equipment, robotic systems, and ISRU demonstrations would be teleoperated from Earth. These continuing activities would be supported by long-lived utilities such as power, communication, and navigation systems. It would also be advantageous to continue operating the crew's roving vehicles via teleoperation. This could extend the range of exploration around the landing site from the 15–20 km explored by the astronaut crew to approximately 50 km. To accommodate this, the long-lived utilities emplaced to support the scientific and ISRU experiments would need to be used.

4.3.7.2 Science Investigations

For the ESAS effort, a team of scientists from the LEAG developed a set of scientific investigations that could be conducted on short-duration lunar sortie crew missions. The science investigations can be categorized as field science, emplacement science, teleoperated science, and operational science.

Field science investigations include activities that the crew will perform to explore and gain an understanding of the landing site. These activities will include making a comprehensive site survey of the area within 15–20 km of the LSAM to develop the geologic context of the site. The crew would collect surface samples representing the different terrains, rocks, and regolith materials (which, through several sortie missions to different sites, should result in a full suite of lunar basalts and highland rocks, impact melt sheets/rocks from as many large craters as possible, and samples of multiple regolith layers, including buried “paleoregoliths”). They would also collect subsurface data and samples by drilling, trenching, and using geophysical profiling techniques or by using natural depressions such as impact craters or lava channels to observe exposed stratigraphy.

Emplacement science uses the deployment of scientific packages to collect long-term measurements of the lunar environment and monitor any changes. The data collected will include geophysical information such as seismicity and heat flow, measurements of the solar wind composition and radiation levels at the lunar surface, the composition of the lunar atmosphere (including dust) and how it changes due to human exploration activities, surface temperatures and reflectivity, and Earth-based radio frequency interference. Other data collection will focus on the long-term effects of microgravity and radiation on molecular and cellular microorganisms and verify radiation-shielding model predictions. Another use for deployed scientific packages is to investigate the ability to use the Moon as a platform for astronomy, with prototype deep-field optical telescopes and radio telescope elements.

Teleoperated science involves the use of robotic systems, or the crew roving vehicles once the crew leaves, by operators on Earth. These mobile systems will be used to extend the comprehensive site survey conducted by the human crew during their stay to greater distances from the landing site. Remote sensing techniques will be used to understand the chemistry and mineralogy of the rocks and regolith and measure local magnetic fields and their variation across the surface.

Operational science is primarily focused on assessing the bio-organic “environmental impact” to the Moon due to human presence, which has implications for planetary protection in both forward- and back-contamination.

A notional schedule of scientific investigations conducted during a lunar sortie crew mission is:

- Day 1: Collect contingency surface samples and deploy scientific packages and robotic systems;
- Days 2 and 3: Conduct field science during surface traverses and correct problems with science packages or robotic systems; and
- Day 4 and beyond: Conduct return visits to sites of particular interest or discoveries and correct problems with science packages or robotic systems.

4.3.7.3 Resource Utilization

ISRU technology demonstrations will include the mining, movement, and/or manipulation of the lunar regolith; the chemical processing of the regolith to produce useful materials such as oxygen, hydrogen, and metals; and demonstration of regolith stabilization techniques for constructing roads and/or landing pads. Other technology demonstrations will likely be associated with the crews’ space suits, portable life support systems, and surface mobility systems in preparation for the long-term use of these items at a future outpost facility. Sortie mission ISRU demonstrations are further discussed in **Appendix 4J, ISRU**.

4.3.7.4 Required Surface System Capabilities

A number of required surface system capabilities have been identified to allow for successful and efficient lunar sortie crew missions, including:

- LSAMs capable of supporting up to 7 days of crew operations on the lunar surface, including the ability to send all crew members out on EVAs each day;
- Robust EVA systems that support daily operations, including space suits and portable life support systems that can operate in all lunar environmental extremes, suits that are flexible and mobile enough to allow geologic field work and the emplacement of scientific packages to be conducted, and portable life support systems that have an on-surface recharge capability and support an 8-hour EVA day;
- Surface mobility assets (i.e., roving vehicles) that support the crew's ability to range up to 15–20 km away from the lander site, which is over the horizon and beyond the “walk-back” distance of Apollo;
- Robotic systems and/or the crew's roving vehicles that allow post-sortie teleoperation for continued remote/robotic science exploration out to approximately 50 km from the lander site. These systems and/or vehicles are equipped with a basic remote sensing capability (i.e., spectrometers, imaging);
- The ability to acquire subsurface information by drilling into the regolith, equivalent to the 3-m depth accomplished on Apollo;
- Long-lived utilities (i.e., power, communication, and navigation) for deployed science packages, ISRU demonstrations, and teleoperated robotic systems; and
- Orbital communication and navigation infrastructure that allow global access for sortie missions, including the near side, far side, and polar regions. These assets should be part of an early infrastructure development in the Robotic Lunar Exploration Program (RLEP) to ensure readiness for lunar sortie crew missions.

4.3.7.5 Mars-forward Operations and Technologies

The short duration of lunar sortie crew missions will limit operational similarities to Mars surface exploration. However, valuable information will be gained in the areas of geologic field techniques, teleoperation of robotic systems and possibly crew mobility systems, and dust mitigation and planetary protection strategies.

The small number of surface systems required for sortie missions also limits the demonstration of technologies linked to Mars exploration. Technologies that can be demonstrated on lunar sortie crew missions include: oxygen/methane rocket propulsion, EVA suits and portable life support, surface mobility such as unpressurized rovers, long-lived scientific monitoring packages, ISRU technologies, a small long-lived power supply, and sealed sample containers.

However, the majority of lunar science activities will be directly applicable to Mars exploration. This is supported by the recent findings of the Moon-Mars Science Linkage Steering Group (MMSSG), convened in 2004 within the aegis of the Mars Exploration Program Analysis Group (MEPAG), and by the Lunar Exploration Science Working Group (LExSWG) final report in 1995 that stated a primary scientific theme of using the Moon as a natural laboratory for studying planetary processes.

4.3.8 Outpost Deployment Studies

In addition to developing the order and manifest of the flights for initial outpost deployment, a variety of special studies was conducted. These studies focused on key questions regarding logistical and operational capabilities during deployment and sustained operations of the outpost.

4.3.8.1 Surface Power System

A conceptual design study of the various options associated with a lunar surface power system was performed to assess the technology and architectural options associated with deploying a power system on the lunar surface, which would fit in a larger lunar surface architecture. In support of this assessment/study, the following GR&As were established:

- Power load profiles based on the lunar surface outpost deployment strategy described in **Appendix 4F, Alternative Outpost Deployment Options**;
- Outpost power was requested by ESAS to be established at an initial capability of 25 kW and a target of 100 with a minimum 10-year outpost operation;
- Outpost primary power system infrastructure architecture candidates based on two primary power plant options:
 - Fission Surface Power System (FSPS), and
 - Photovoltaic (PV)/RFC;
- Lunar Radioisotope Power System (LRPS) availability limitations and power plant characteristics limit application to supplemental or special-purpose power needs;
- Power system sizing was performed for equatorial, mid-latitude, and polar locations; and
- Basis of estimates:
 - System performance and sizing are based on calculations, and
 - Masses are based on calculations and/or engineering estimates, not detailed designs in most cases.

Using these assumptions, top-level power systems designs were created in order to evaluate the merits of each system. In some cases, trades were also performed within a power system option (e.g., mobile surface reactor versus stationary reactor, coupled with a mobile distribution system). In addition, each top-level power system design option was then evaluated against a set of FOMs in an attempt to determine the optimized power system architecture. The FOMs for this assessment were determined to be safety and mission success, extensibility/flexibility, programmatic risk, and affordability. However, as can be seen in **Table 4-28**, no top-level power system option stood out as the clear optimum solution.

Table 4-28. Power System FOMs

FOMs		FSPS	PV/RFC Power System	Hybrid Power System	LRPS
		Supplemental power source only; not comparable to first three options			
Safety and Mission Success		Robust power; autonomous; mass scales well with power; 2-km keep-out zone	Highly site sensitive; Higher mass except under ideal illumination; graceful degradation	Diversity of sources; more graceful degradation; highly site sensitive	Autonomous; smaller keep-out zone
Extensibility/Flexibility	Lunar Flexibility	Low sensitivity to outpost location	100 kWe mass prohibitive except at ideal site	Low sensitivity to outpost location after FSPS placement	Can be mobile
	Mars Extensibility	Atmosphere will affect outer shell and radiator design	Reduced solar flux yields significantly larger arrays	Atmosphere will affect outer shell and radiator design plus larger solar arrays	Atmosphere will affect outer shell and radiator design
Programmatic Risk	Technology Development Risk	Need to develop infrastructure, system not yet at TRL-6, Many design options	System not yet at TRL-6; alternatives to RFC at even lower TRL	System not yet at TRL-6	System not yet at TRL-6, design options
	Cost Risk	Significant infrastructure cost	Substantially lower DDT&E cost	Significant infrastructure cost	Significant costs in increasing heat source availability
	Schedule Risk	If start FY06	If start FY06	If start FY06	If start FY06
	Political Risk	National Environmental Policy Act (NEPA)	None	NEPA	NEPA
Affordability	Technology Development Cost	High, ground test reactor	Relatively Low	Two concurrent programs	Relatively low
	DDT&E Cost	\$3+B class	\$2B class	\$4+B class	\$1+B class
	Facilities Cost	Cost of nuclear infrastructure	Existing facilities may need mods for 1/6th g simulation	Cost of nuclear infrastructure	Cost of nuclear infrastructure
	Operations Cost	Relatively low	100 kWe system requires most launches	Relatively low	NSRP process for multiple launches
	Cost of Failure	High consequences if first reactor fails	High mass for replacement	Diversity of sources gives redundancy	Existing
Legend:	Best	Few challenges	Moderate challenges	Serious challenges	Potential show stopper

The team concluded that a fission nuclear power system offered the best solution, based on somewhat subjective evaluation of the FOMs coupled with consideration of the lunar architecture as a whole. It was felt that extensibility/flexibility should be held as the primary FOM. This was driven by consideration of the intended purpose of lunar experience as a precursor to the exploration of Mars. In addition, a more flexible power system design could mitigate cost, schedule, and/or technical issues of other lunar architecture elements (e.g., ISRU systems). From that vantage point, a fission surface power which is more extensible to Mars and offers more “graceful” or gradual scaling (i.e., mass increase is minimal as a result of increases in output power (**Appendix 4G, Surface Power System**)) to increasing power would bring far more flexibility to the overall lunar architecture. Gradual scaling was considered particularly attractive, considering the low fidelity of the load estimations for various lunar architecture elements and the potential for growth during more detailed design efforts. Consequently, the preferred power system option was determined to be Fission Surface Power System (FSPS).

As a result of the trades and analysis of the various power system architecture options studied during this assessment, several key conclusions were drawn:

- All of the various options are of relatively high mass. The best possible solutions appear to be, at a minimum, in the 10- to 16-mT range to provide 100 kWe (i.e., FSPS) at the outpost and many of the solutions are in the 20-mT range.
- All of the power systems options identified will require significant development to achieve TRL-6, and there do not appear to be any practical solutions using demonstrated technologies. The most “traditional” approach is to use the PV/RFC option, but there are development and life challenges even with these systems that have a significant amount of operational experience in space. There are also several long-lead item areas that will need to be addressed early in the development program, including reactor development (for FSPS) and RFCs (for PV/RFC). In addition, the PV/RFC system will require significant further study to determine the feasibility of the design.
- Each power system option also has its own inherent sensitivity to its location on the lunar surface. As a result, the team strongly recommends obtaining 1 m or better resolution lunar topographic, illumination, and surface/subsurface composition data during either the robotic or sortie missions prior to lunar outpost deployment. It was determined that high landing accuracy in geographic locations (low 10’s of meters) and orientation (with respect to either Sun and/or outpost location) would substantially reduce deployment risk and increase system optimization. This is of particular importance to the PV/RFC system. In addition, the PV/RFC option appears to not be practical for locations outside very limited polar regions, if 100 kWe continuous power is required. This is due to the lack of an effective energy storage system.
- Each of the power systems options was also deemed to be sensitive to the lander system configuration. While this is not deemed a technology issue, there will be a significant engineering/development effort required to integrate these power systems options on a lander. This is due to each option having large deployable structures such as radiators and the PV/RFC option also having a large deployable solar array. In addition, the FSPS option will also have to address separation of the reactor from the lunar habitat. As a result of the reactor masses, it was determined that utilization of a mobile power distribution cart is an appropriate method to achieve this separation. This does, however, increase the deployment complexity of the overall system.
- Each of the options appears to be robust with respect to the 10-year operational lifetime requirement. None of the systems have a great sensitivity to micrometeoroids and are able to achieve the required lifetime. There may be logistics issues, however, associated with the PV/RFC systems, and each option will require further study to address system repair and/or maintenance.

Each power system architecture option was evaluated against a relevant set of FOMs, which, for this assessment, was determined to be safety and mission success, extensibility/flexibility, programmatic risk, and affordability. As shown in Table 4-28, however, no top-level power system option stood out as the clear optimum solution. The team felt that a fission nuclear power system offered the most optimum solution based on an evaluation of the FOMs, coupled with consideration of the lunar architecture as a whole. This was due to the flexibility offered to the entire lunar architecture and to its extensibility to Mars, which was considered as a prime driver to the exploration of the lunar surface.

Other power systems technologies may also play a role in the overall power system architecture. As an example, radioisotope systems make an attractive power system choice for mobility systems or for small isolated experiment elements. In addition, PV systems would be required for start-up of the reactor system. Consequently, each of the technologies addressed in this assessment potentially play a role in the overall architecture on the lunar surface.

The above analysis is based on the assumptions of an outpost deployed by a short series of dedicated cargo landers and the availability of these landers to deliver the surface power system. Alternative outpost deployment methods, such as an “incremental build strategy” that utilizes only sortie missions to deploy an outpost in smaller elements, will require reexamination of the choice of power system.

4.3.8.2 Navigation

Navigation strategies were developed for both lunar landing and surface operations. Both of these types of navigation required the team to develop a set of reference performance requirements that should be reexamined during future efforts to match with any changing mission requirements. The navigation strategies for both types of operations are described in the following sections.

4.3.8.3 Descent and Landing Navigation

There were two top-level requirements around which the descent and landing navigation strategy was formulated, including:

- The first outpost deployment flight shall have a landing precision of ± 500 m; and
- All subsequent flights to the vicinity of the future habitat location shall have a landing precision of ± 100 m.

Furthermore, the strategy was developed in such a way that it was not dependent on the emplacement of navigational aids by lunar sortie mission crew members. While there is a possibility that precursor missions might be flown to the outpost site, due to the uncertainty associated with the assumption that the robotic missions could be used to emplace hardware (or have a lifetime to act as navigational aids themselves), it was decided that the strategy should reflect an approach that was independent of precursor/sortie mission infrastructure emplacement.

The landing navigation strategy that was developed is based on assistance from the DSN (or similar system) for tracking and orbit determination, lunar surface feature tracking for orbit determination and descent navigation, landing site tracking (including hazard detection) for terminal descent/landing, and possibly an altimeter for landing (necessity depends on hardware used for landing site tracking). It was an assumed requirement that the crew will have the ability to assume control of the LSAM upon landing in order to re-designate a landing site or control the orientation of the spacecraft. It was also recommended that the cargo mission flights maintain this redesignation/reorientation capability while being controlled from Earth. This provides a backup mode of landing hazard avoidance in addition to the autonomous systems that will likely be present.

Given this strategy, it was felt that the LSAM-related hardware required to perform these functions was either presently available or could easily be obtained prior to the date of required usage. The future availability and capability of the DSN or similar systems are still in question.

4.3.8.4 Surface Navigation

For the purposes of this study, the requirements for local (less than 3 km radius from the habitat), near-field (less than 15 km radius from the habitat), mid-field (less than 30 km radius from the habitat), and far-field (greater than 30 km radius from the habitat) were established. There were three top-level requirements around which the descent and landing navigation strategy was formulated:

- A crew member's location shall be known relative to the outpost to within 100 m during nominal operations. Position knowledge approaching 10 m is desired. The following scenarios describe nominal field operations:
 - Within 3 km of the outpost, the EVA crew may travel by foot (without a rover);
 - Between 3 km and 15 km of the outpost, at least one unpressurized rover will always be within 200 m of the EVA crew;
 - Between 15 km and 30 km of the outpost, at least two unpressurized rovers will always be within 200 m of the EVA crew.
 - At distances greater than 30 km (and approaching 100 km) of the outpost, at least one pressurized rover will always be within 500 m of the EVA crew.
- During off-nominal conditions, a crew member shall be able to find their way back to within 100 m of the outpost; and
- The location of a pressurized/unpressurized lunar rover shall be known (relative to the outpost) to within 100 m. Position knowledge approaching 10 m is desired.

Given these requirements, the team decided to adopt a strategy that did not require the use of orbital or Earth-based assets. It was felt that sufficient position and heading knowledge could be obtained through the use of “autonomous” navigation systems that are initialized at the beginning of each traverse, similar to Apollo. Multi-day traverses might require reinitialization based on maps, but these types of traverses will not become an issue until pressurized far-field traverses are attempted at some point later in the program.

Orbital navigation systems were considered, but ruled out, for the following reasons. In comparing relative costs, the “autonomous” system is much more competitive in providing, in a timely manner, a navigation system that has the required accuracy. A “Global Positioning System- (GPS-) type system” could be employed, but the costs associated with developing, deploying, and maintaining such a system that provides readily available location and heading data could be prohibitive. While a partial constellation could be deployed, it would incur a performance penalty manifested as a time-delay (i.e., the on-orbit assets would need to perform multiple overhead passes in order to provide the necessary position knowledge). This is an undesirable solution—especially in the case of an EVA team whose rover has failed, in which case the crew members would need to walk back to the habitat. Given the limited life of the crew members' suits, delays in position and heading knowledge would have significant impacts to their ability to return to the habitat safely.

Given the adopted strategy, it was felt that the surface navigation hardware required to perform these functions was either presently available or could easily be obtained prior to the date of required usage. The performance goal to obtain position knowledge approaching 10 m will be a cost driver; however, because this goal is not a requirement, flexibility is available to trade cost versus performance.

It is important to note that none of the landing or surface navigation performance requirements caused a great deal of controversy among the navigation community supporting this portion of the ESAS. However, the solutions should be considered as notional, since much work remains to prove that the performance can be achieved with the stated strategies.

4.3.8.5 Communication

The communication strategy is driven by both the sortie and outpost mission requirements. The sortie missions are intended to have global access to perform operations during short periods of time (up to 7 days) anywhere on the lunar surface. Alternatively, the outpost is intended to have continuous, concentrated operations in a specific location that does not necessarily have a continuous view of Earth.

During both types of missions, it would be highly desirable to maintain constant communication with Earth. Therefore, 24 hours per day/7 days per week (24/7) coverage at the mission site throughout the duration of the mission was treated as a requirement. Furthermore, it was decided that 24/7 global availability should be provided. While this could be relaxed, resulting in a reduced constellation, it would impose restrictions on mission timing, mission duration, and/or mission location. In addition to the communication requirements between the lunar surface and Earth, a requirement from the EVA Project Office imposes the necessity to maintain constant communications between surface crew members, regardless of their distance from the habitat.

In order to provide real-time, global, continuous communications with Earth, a constellation of satellites, deployed in lunar orbit, is needed. This constellation would inherently provide the ability to maintain constant communication between crew members operating on the lunar surface. Additionally, Local Area Networks (LANs) might be established in the areas of high activity (e.g., in the vicinity of the habitat). Available bands will include Ultra-High Frequency (UHF) to provide surface-to-surface audio and low-data rate exchange; S-Band to provide surface-to-surface medium-data rate exchange; X-Band to provide Earth-to-relay vehicle low-data rate exchange; and Ka-Band to provide surface-to-surface and Earth-to-surface high-data rate exchange.

4.3.8.6 ISRU

Although the lunar program was not dependent on the success of the ISRU strategy, ISRU was incorporated into the architecture such that its associated systems were deployed and tested early in the lunar program. The magnitude of consumables that will be pursued through ISRU is an open issue, pending the outcome of economic and technical analysis. However, for the purposes of this study, it was assumed that a capability to produce at least enough O₂ to resupply the habitat would be pursued.

The initial lunar surface testing of some ISRU systems and processes was incorporated into the sortie mission strategy. These demonstrations primarily focused on proving the chemical reactions associated with the evolution of O₂ from the lunar regolith. If successful, the first outpost deployment flight will carry a pilot lunar miner/hauler unit and possibly a Lunar Polar Resource Extractor (LPRE) (pending the outcome of H₂ availability investigations in the lunar polar region) to the lunar surface. In addition to providing the ability to test the miner/hauler and LPRE early in the program, manifesting the miner/hauler on an early flight will allow it to be used to excavate the terrain at the site of the outpost.

The third outpost deployment flight will deliver a lunar oxygen pilot plant and an ISRU logistics carrier to the lunar surface. This pilot plant will be sized to produce a quantity of consumables ranging from the minimum required to resupply habitat O₂ to the maximum necessary to fuel two LSAM ascent stages per year. The logistics carrier will be sized accordingly to transport and deliver the O₂ to the appropriate elements. There should be a testing period for these elements prior to inserting them into the critical path to ensure that the process can operate successfully and the required purity of the products can be obtained. At a later date, larger-scale ISRU operations may be undertaken, although their magnitude will be dependent on the applications for which they are intended. More details on the initial outpost ISRU strategy are found in **Appendix 4J, ISRU**.

4.3.8.7 EVA Capabilities

Of special interest are the EVA capabilities, since many of the lunar mission objectives are executed through the use of EVA. Significant recent efforts have been undertaken within ESMD studies to establish a baseline set of capabilities and an understanding of the associated support systems. Many details on the evolving lunar EVA strategy can be found in the reports that were generated during the course of the ESMD studies, but some of the major points related to field operations are as follows:

- EVA range (assume two-person nominal rovers)
 - No rover: without a rover, the maximum range available will probably be on the order of 1–3 km;
 - Single rover: The achievable distance possible with a single rover will be constrained by the walk-back distance of 10–15 km; and
 - Two rovers: If a backup rover is provided to the single rover, the walk-back requirement can be avoided. The ultimate distance will then be dictated by either the quantity of consumables carried on the rover or by the crew member-suited physiological guidelines (approximately 8 hours). It is assumed that the physiological limit, which would allow an ultimate range of approximately 20–30 km, is the constraint. This strategy also allows for the ability of two EVA teams to simultaneously explore up to walk-back distances which, in turn, may increase the science return substantially, especially given that there will be relatively short periods of “favorable” EVA time for exploration within a lunar cycle or during the short reconnaissance missions.
- EVA suit: 4-hour uninterrupted operation. Recharge allows 6–8 hour EVA;
- Work Efficiency Index goal: 1.75 (currently 0.43 for ISS); and
- A planetary suit used for nominal surface operations and an in-space suit used as backup, but not designed for repeated surface EVAs.

The initial and evolutionary EVA field capabilities are shown in **Figure 4-56**.

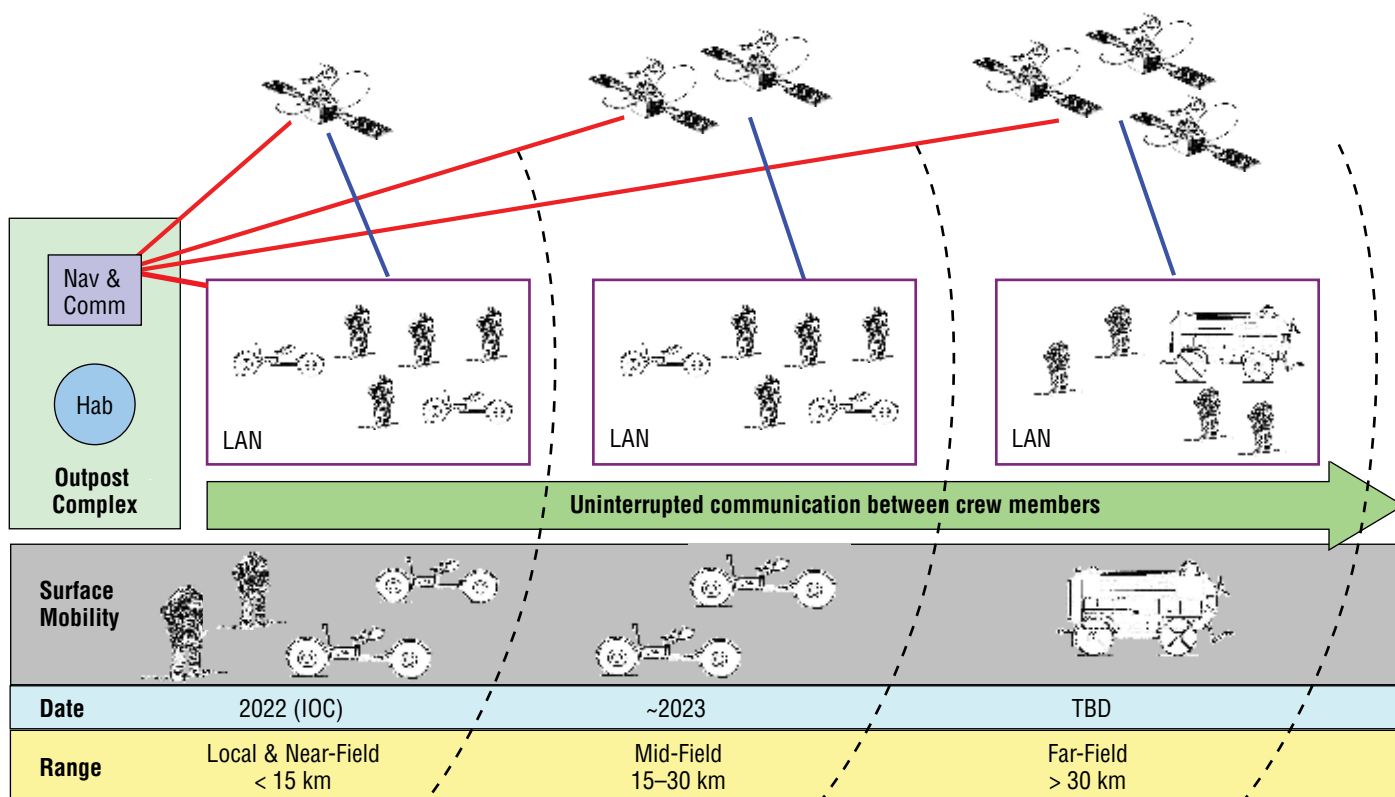

Figure 4-56. Initial and Evolved EVA Field Capabilities

4.3.8.8 Outpost Deployment Conclusions

This lunar surface outpost deployment strategy was developed as part of an overall lunar program strategy led by the ESAS team. Therefore, in order to develop a deployment strategy that was consistent with the overall program strategy, a number of key mission parameters and assumptions (e.g., crew size, mission duration, outpost location, etc.) were adopted.

The primary purpose of developing the outpost deployment strategy was to determine the order and manifest of the flights required to deploy a core set of lunar surface capabilities for sustained, concentrated lunar operations and to provide for the evolution of the surface capabilities as the lunar program progresses. The strategy for outpost deployment was found to be highly dependent on the initial mission parameters and assumptions.

A core set of elements is required in order to enable the key capabilities associated with maintaining a human presence on the lunar surface (e.g., habitat, EVA suits, etc.). Additional elements can be added to the architecture depending on the desire to seek greater degrees of self-reliance (e.g., ISRU) or seek to operate in operationally challenging areas (e.g., out of constant view of Earth). It should not only be expected that performance requirements will grow or change with time (e.g., expanding EVA traverse capabilities), but they should change in order to take advantage of a growing set of surface assets and crew availability (e.g., payload unloading strategies).

The intent of this activity was to gain a general understanding of a reasonable approach for lunar surface operations and outpost deployment. The approach outlined above represents only one point along a continuum of possible outpost deployment strategies. Many of the decisions made within this outpost deployment strategy will be reexamined not only to incorporate final decisions that were made in parallel to this activity, but to also develop the concepts in greater detail and explore their alternatives. (See **Appendix 4F, Alternate Outpost Deployment Strategies**, for a discussion of alternative deployment strategies.)

4.3.9 Outpost Mission Surface Activities

As part of the ESAS efforts, a lunar outpost crew mission DRM was developed to describe the types of activities that will occur on the lunar surface during sustained operations at a lunar outpost. The goals of these long-term activities are:

- Take advantage of long-duration human presence to conduct detailed scientific investigations and construct large science facilities;
- Transition ISRU from demonstration to production and incorporation into areas such as life support consumables, spacecraft propellants, and construction materials;
- Understand the integrated effects of long-term low-gravity, radiation, lunar dust, and isolation on the human body in the Moon's environment;
- Conduct Mars-forward testing of operational techniques and planetary surface systems;
- Allow for commercial opportunities to arise that provide services or products related to the operation of the lunar outpost.

The guidelines and assumptions used in the development of the lunar outpost crew mission DRM were: a crew size of four; a crew surface mission duration of 6 months; a crew rotation every 6 months resulting in a permanent human presence on the Moon; uncrewed cargo missions every 6 months (offset from crew missions by 3 months); and the outpost delivered and mostly deployed robotically prior to the arrival of the first outpost crew.

4.3.9.1 Surface Mission Description

When the initial lunar outpost crew mission arrives at the Moon, the outpost consisting of a habitat, power supply, communication and navigation infrastructure, and surface mobility and robotic systems will already be emplaced. However, it is likely that the crew will have some final assembly and verification tasks to make the outpost operational. Until this process is complete, the four crew members will live in the LSAM. Once the outpost is declared operational, the LSAM will be powered down and kept in a quiescent state for the duration of the 6-month surface mission.

A new outpost crew will arrive at the Moon every 6 months, and there will be a brief period (a few days) where the residing lunar crew will debrief the arriving crew on the status of the outpost and the ongoing research being conducted. During this time, there will be eight people occupying the outpost. After the crew rotation is completed, the departing crew will leave the Moon in the same LSAM that delivered the previous crew. This is operationally similar to the way Soyuz modules are currently changed out at the ISS and ensures that any LSAM does not sit on the Moon for longer than 1 year.

Automated cargo missions will also arrive at the lunar outpost to deliver needed supplies and equipment. One automated cargo mission will land on the Moon every 6 months, with the 6-month centers being offset by 3 months from the crew missions. The outpost crew residing on the Moon when the cargo arrives will be involved in unloading the cargo lander and resupplying the outpost with consumables. Replacement consumables could include life support (air, food, and water), medical supplies, cleaning supplies, personal hygiene items, data storage media, and batteries for small equipment. Modular parts, tools, and supplies to replace or repair failed systems, new science experiments or analytical equipment, and additional specialized robotic systems could also be delivered.

While surface operations during sortie missions were dominated by EVA on the lunar surface, a more balanced schedule of EVA and IVA inside the habitat will occur during crew missions at the outpost (**Figure 4-57**). Sustained EVA over the 6-month outpost crew missions will be limited by the extreme radiation environment on the lunar surface and the accumulated dose each individual crew member receives, the fatiguing nature of EVA operations, space suit maintenance and repair, and portable life support system logistics. Also, while every EVA conducted during sortie missions consisted of all four crew members at the same time, more EVAs during an outpost mission will consist of a single two-person team, with two different teams conducting EVAs on alternating days.

Figure 4-57. Notional Schedule for a Typical Week at a Lunar Outpost

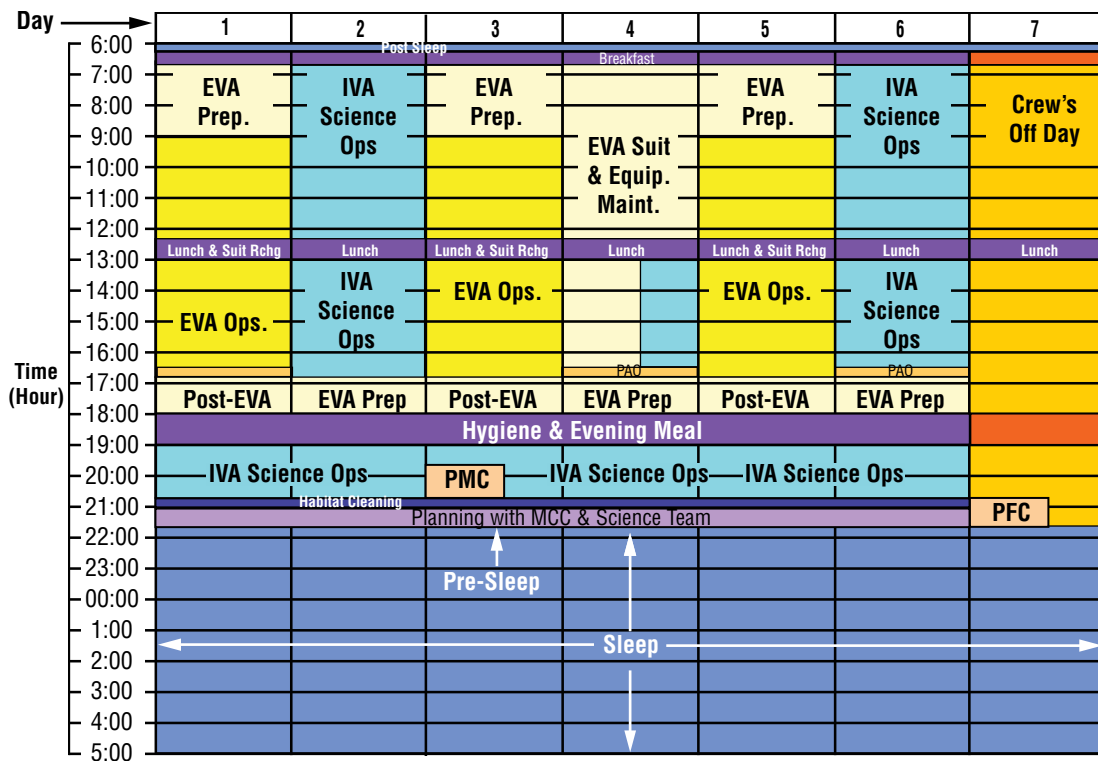

Because of the long-duration of outpost crew missions, the crew's schedule of activities on the lunar surface will not be as "scripted" or tightly controlled as sortie missions. Activities and milestones will be planned more on a weekly basis, rather than the daily basis of sortie missions, and surface operations will gradually transition from Earth-dominated control to local control and crew autonomy. This crew-centered approach to surface operations will be needed on Mars, where the time delay associated with Earth-Mars communications prohibits Earth-based control. Also, as with the ISS, long-duration crews will need "off-duty" and/or "light duty" days where there are no or minimal scheduled activities.

Surface mobility will remain a key asset on the lunar surface at the outpost for all of the same reasons it is important on crew sortie missions. In addition to the 15–20 km exploration range of the unpressurized roving vehicles used on crew sortie missions, outpost crews will also need the use of pressurized rovers, in which crews can operate for days at a time in a "shirt-sleeve" environment away from the outpost. Pressurized rovers would be used much in the same way small submersible craft are used to explore under the seas on Earth. A single pressurized rover could extend the range of human exploration to approximately 50 km away from the outpost, with appropriate planning for crew safety considerations in the event of a rover failure. A second pressurized rover would allow exploration beyond 50 km.

4.3.9.2 Science Investigations

Geoscience activities will include all of the activities conducted during crew sortie missions, but would cover a larger surface area. The longer duration of outpost missions would also allow more detailed studies to be pursued, such as investigating the layered nature and formation process of the lunar regolith. Two new areas of exploration science that will occur at the outpost will involve the crew's use of teleoperated robotic explorers and the ability to perform preliminary chemical and mineralogical analyses on geologic samples. All of the geoscience activities performed on the Moon will demonstrate the equipment and techniques that will enable the efficient geologic exploration of Mars and other destinations in the solar system. Also, the knowledge gained on the basic geologic processes, such as impact and volcanism, will help scientists better understand how these processes occur throughout the solar system.

Other sciences, such as space physics and astronomy, will benefit from the long-duration outpost missions with the ability to build up large-surface infrastructure projects, such as large aperture optical or radio telescopes, or arrays of smaller telescopes acting together as an interferometer.

Life science research and medical operations will allow scientists to begin to understand the long-term effects on the human body of living and working on a planetary body. Medical care techniques such as preventive medicine, telemedicine, and trauma care, countermeasure procedures such as exercise regimens and nutrition, and research on topics such as bone loss, cardiovascular/cardiopulmonary function, skeletal muscle status, and neurological function will improve our ability to keep astronaut crews healthy and productive on long-duration space missions.

4.3.9.3 Resource Utilization

During the outpost missions, the use of in-situ resources will transition from demonstration to incorporation, and ISRU technologies successfully demonstrated on the sortie missions will be scaled up to production-level plants and facilities (**Figure 4-58**). Early activities will include surface construction of berms near landing zones to protect surface assets against regolith blast ejecta from landing spacecraft and roads on highly trafficked paths to reduce the mobilization of lunar dust and the wear on surface mobility systems. Also, the production and storage of life support consumables such as oxygen for the crew’s habitat and EVA systems will begin the transition from reliance on Earth-supplied logistics to self-sufficiency on the Moon. As production rates increase, lunar resources will provide the propellants needed by the landing spacecraft, which will lead to basing and servicing of reusable spacecraft on the Moon’s surface.



Figure 4-58. Lunar Crew Discussing Outpost Operations With ISRU Facilities in Background

New ISRU capabilities can be demonstrated and incorporated into mission plans on an as-needed and evolutionary basis to lower the cost of outpost missions and demonstrate capabilities that may be required for long-duration stays on the Mars surface. One area that may be critical for long-term lunar operations and trips to Mars where logistics management may be difficult is in-situ manufacturing and repair. This capability includes the ability to fabricate spare parts—especially for high-wear excavation and regolith processing items—and repair techniques for both internal and external hardware. Fabrication processes of interest include additive, subtractive, and formative techniques for multiple feedstock materials (metals, plastics, and ceramics). A “machine shop” capability that includes repair techniques and part characterization may be required. Initially, feedstock from Earth can be used for manufacturing parts; however, resources from regolith to support this capability would be required for permanent surface operations.

The ability to extract metals (iron, titanium, aluminum, etc.) and silicon from regolith is of interest to support in-situ manufacturing and construction capabilities that could be used to lower the cost of infrastructure growth during the outpost phase. Included in this work is development of other manufacturing and construction feedstock, such as concrete, wires, basaltic fibers and bars, metal tubing, etc. Several oxygen extraction concepts can be modified to include additional steps to extract these resources for use in construction feedstock.

Depending on the duration and scope of the outpost phase, the ability to construct landing pads, structures, habitats, observatories, and other infrastructure items of interest from in-situ materials may become important. In-situ fabrication of energy/power generation such as lunar array production may also be of interest for both infrastructure growth and space commercialization potential. Studies and laboratory work have been performed to show that production of solar arrays with minimal Earth consumables is feasible.

A further area of interest during the outpost phase will be internal and external waste recycling. At this time, large amounts of plastic and metal “trash” on the ISS are disposed of on Progress vehicles during atmospheric reentry. These carbon, hydrogen, and metal resources could be critical in supporting in-situ manufacturing and repair capabilities. Also, non-reusable landers surrounding the outpost may be ready sources of carbon, metals, and plastics for in-situ processing. Lastly, reuse of transportation assets will be required for human lunar exploration to become economical in the long-term. Instead of only supplying propellant to ascent stages, deploying a single-stage lander that can be refueled to either return to Earth or travel to another location on the lunar surface would significantly enhance the science return of human lunar operations. For this to occur, production of oxygen (and fuel if possible) would have to be scaled up to between 30 and 60 mT per year. Outpost ISRU capabilities are further detailed in **Appendix 4J, ISRU**.

4.3.9.4 Required Surface System Capabilities

To support the diverse set of surface operations described above, the lunar outpost must provide certain capabilities as part of its design. The most critical capability is the ability to support frequent and substantial EVAs. Important EVA surface systems include: (1) space suits that are flexible and lightweight, yet durable and maintainable, and allow for 8 hours of work; (2) an efficient airlock that not only provides access to the surface, but also protects the habitat and crew from lunar dust and provides an area to repair and service the space suits; and (3) surface mobility systems to allow the crew to efficiently explore the region surrounding the outpost.

The human crews will need to be aided in their explorations by robotic systems capable of teleoperation by the outpost crew or operators on Earth. Robotic explorers will provide the planet-wide reconnaissance needed to develop a global understanding of the Moon. Robotic systems will also provide the majority of the ISRU regolith mining and manipulation equipment.

As lunar samples are collected, the ability to analyze those samples with laboratory equipment will become necessary, since the number of samples collected during a long-duration outpost mission will far exceed the amount able to be returned to Earth. Analytical laboratories and equipment will also be needed to support biological investigations concerned with understanding the integrated effects of low gravity, radiation, and dust on the human body, as well as astrobiological investigations associated with planetary protection and the detection of extra-terrestrial life.

Exploration of the Moon will not be restricted to the lunar surface. Subsurface exploration will also be vital to understanding the Moon as a whole. Therefore, systems to allow drilling, trenching, and geophysical profiling must be present. Drilling to depths of tens of meters will be needed to reach the base of the regolith and hundreds of meters will be needed to penetrate into the megaregolith. Geophysical techniques will benefit most from stations separated by great distances. While these can be deployed during sortie missions as well, the outpost robotic systems and small, remote, long-lived power and communication systems will be needed to establish and maintain the network of stations.

As outpost activities increase in scale, power on the order of 100 kW will be needed, particularly for ISRU processing plants. This likely will require nuclear power supplies. Habitat systems that will be critical to this endeavor must have a regenerative life support capability to minimize the consumables resupply and radiation protection, thus enabling the habitat to serve as a safe haven in the event of a solar proton event.

4.3.9.5 Mars-forward Operations and Technologies

Most aspects of lunar outpost crew missions will build experience that directly applies to operations on Mars. Short-duration (less than 90 days) and long-duration (approximately 500 days) Mars surface missions can each benefit from the confidence gained in crew operations and system reliability based on the 180-day lunar missions.

Operationally, the most important concepts to be developed during lunar outpost crew missions include crew autonomy and crew teleoperation of robotic exploration systems. It may be desirable at some point in time to implement Mars-like time delays in lunar outpost communications with Earth and daily activities based on a Martian Sol (24 hours, 39 minutes).

From a systems perspective, the most important technologies to be demonstrated on the Moon include oxygen-methane rocket propulsion, long-lived power generation, regenerative life support, teleoperated robotic systems, EVA systems (suits and unpressurized and pressurized roving vehicles), geoscience and bioscience analytical equipment, medical and telemedicine equipment, dust mitigation and planetary protection equipment, and ISRU mining and storage/distribution systems.

Because of the different environments on the Moon and Mars, certain technologies used on the Moon may require some significant modifications before being used on Mars. These include thermal rejection systems for power systems and habitats (Martian atmosphere), ISRU chemical processes (different resources), EVA space suits, portable life support systems, and roving vehicles (higher Mars gravity).

4.3.10 Robotic Precursor Missions

Robotic missions to the Moon should be undertaken prior to human return to the Moon for several reasons. Robotic missions can collect strategic knowledge that permits safer and more productive human missions. Such data includes information on lunar topography, geodetic control, surface environment, and deposits of largely unknown character, such as those of the polar regions. This information can be collected by a variety of spacecraft, including orbiters and soft landers.

In addition to collecting important precursor data, robotic missions can deliver important elements of the surface infrastructure to the eventual outpost site. Such deliveries include exploration equipment (i.e., rovers) and scientific instrumentation (i.e., telescopes). Additionally, since the extraction of resources will be an important human activity on the Moon, robotic precursors can deliver elements of the resource processing infrastructure, including digging, hauling, and extraction equipment. It is likely that mission planners will want to experiment with various processing techniques and methods of extraction, and robotic missions can demonstrate process techniques at small scales in advance of the requirement to put large amounts of infrastructure on the lunar surface. Further discussion of robotic lunar precursor activities is contained in **Appendix 4I, Lunar Robotic Precursor Missions**.

4.4 References

1. Arnold, J.R. (1979) Ice in the lunar polar regions, *J. Geophys. Res.* 84, 5659-5668.
2. Bussey D.B.J., Fristad K.E., Schenk P.M., Robinson M.S., and Spudis P.D. (2005) Constant illumination at the lunar north pole. *Nature* 434, 842.
3. Bussey, D. B. J., Spudis, P. D., Robinson, M. S. (1999) Illumination conditions at the lunar south pole. *Geophys. Res. Lett.* 26, No. 9, 1187.
4. Eppler D.B. (1991) Lighting constraints on lunar surface operations. NASA Tech. Memo. 4271, 22 pp.
5. Feldman, W. C., S. Maurice, A.B. Binder, B.L. Barraclough, R.C. Elphic, D.J. Lawrence (1998) Fluxes of Fast and Epithermal Neutrons from Lunar Prospector: Evidence for Water Ice at the Lunar Poles. *Science* 281, 1496-1500.
6. Mumma M.J. and Smith H.J. (eds.) (1990) *Astrophysics from the Moon*. AIP Conference Proceedings 207, 656 pp.
7. Nozette S., P.D.Spudis, M. Robinson, D.B.J. Bussey, C. Lichtenberg, R. Bonner (2001) Integration of lunar polar remote-sensing data sets: Evidence for ice at the lunar south pole. *J. Geophys. Res.* 106, E19, 23253-23266.
8. Taylor G.J. and Spudis P.D., eds. (1990) *Geoscience and a Lunar Base: A Comprehensive Plan for Lunar Exploration*. NASA Conference Publication 3070, 73 pp.

4.5 Endnotes

1. "Pioneering the Space Frontier: The Report of the National Commission on Space," NASA/Bantam, May 1986.
2. Ride, Sally K., PhD., "Leadership and America's Future in Space," National Aeronautics and Space Administration, August 1987.
3. "Beyond Earth's Boundaries: Human Exploration of the Solar System in the 21st Century, 1988 Annual Report to the Administrator," National Aeronautics and Space Administration, November 1988.
4. "Exploration Studies Technical Report, FY1989 Annual Report," NASA Technical memorandum 4170, Office of Exploration, National Aeronautics and Space Administration, August, 1989.
5. "Report of the 90-Day Study on Human Exploration of the Moon and Mars," National Aeronautics and Space Administration, November 1989.
6. "America at the Threshold, Report of the Synthesis Group on America's Space Exploration Initiative," Superintendent of Documents, U.S. Government Printing Office, May 1991.
7. Results from the First Lunar Outpost activity were never formally documented, although much of the planning data has been retained at the Johnson Space Center. Internal NASA use only. Distribution limited.
8. "Human Exploration of Mars: The Reference Mission of the NASA Mars Exploration Study Team," NASA Special Publication 6107, July 1997.
9. "Reference Mission Version 3.0 Addendum to the Human Exploration of Mars: The Reference Mission of the NASA Mars Exploration Study Team," NASA Special Publication 6107-ADD, June 1998.
10. Results from the Mars Combo Lander and Dual Lander studies were never formally documented, although much of the planning data has been retained at the Johnson Space Center. Internal NASA planning report. Distribution limited.
11. "Report of the NASA Exploration Team Setting a Course for Space Exploration in the 21st Century," Internal NASA planning report, February 2002. Distribution limited.
12. "Advanced Concept Analysis in Support of the Integrated Space Plan," Internal NASA planning report, November 2002. Distribution limited.
13. "Next Steps in Human and Robotic Exploration," Internal NASA planning report, May 2003. Distribution limited.
14. "Lunar Architecture Focused Trade Study Final Report, Revision A", NASA, Exploration Systems Mission Directorate, ESMD-RQ-0005, February 4, 2005.
15. "Lunar Architecture Broad Trade Study Final Report, Revision A", NASA, Exploration Systems Mission Directorate, ESMD-RQ-0006, February 4, 2005.

