

"Towards an Earth-Moon Economy - Developing Off-Planet Resources"

# Moon Miners' Manifesto



[www.MMM-MoonMinersManifesto.com](http://www.MMM-MoonMinersManifesto.com)

MMM Classic Themes

Lunar Architecture & Construction

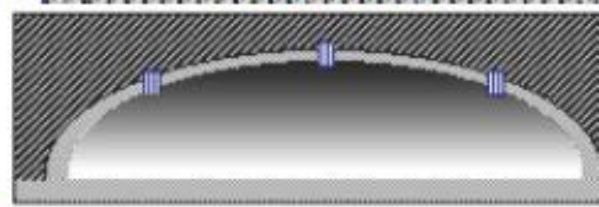
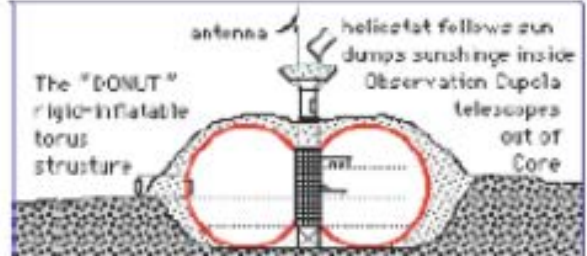
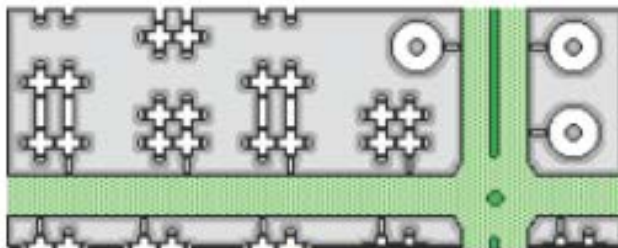
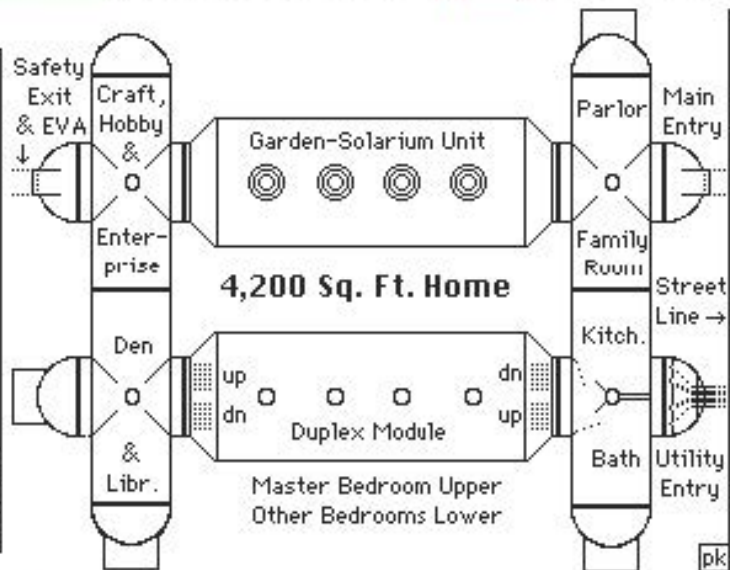
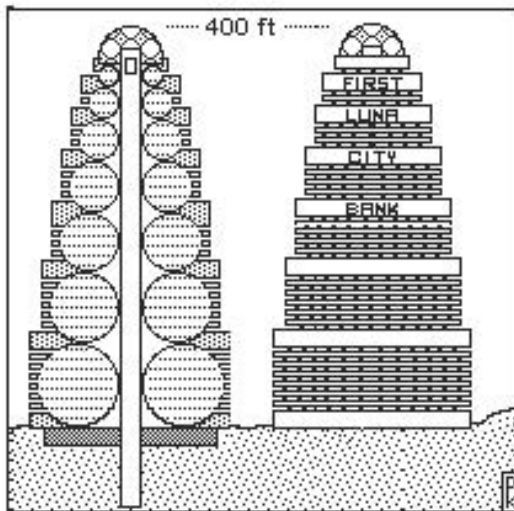
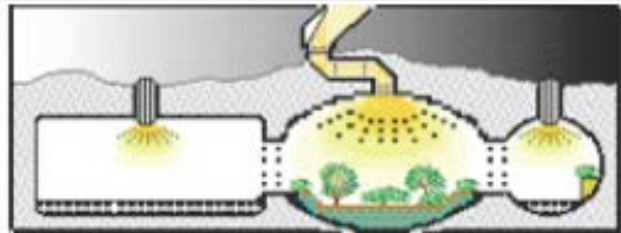

## CHRONOLOGICAL INDEX MMM THEMES: Lunar Architecture & Construction

- MMM # 1 M is for Mole
- MMM # 2 M is for Metropolis
- MMM # 3 M is for Mare/Maria, Multiple Sites, Mounds; Building a Concrete Outpost
- MMM # 5 Lunar Architecture; M is for Middoors, Matchport
- MMM # 8 Parkway
- MMM # 16 Glass–Glass Composites
- MMM # 17 Liquid Airlocks
- MMM # 18 Strategy For Following Up Lunar Soil–Processing With Industrial M.U.S.–c.l.e.
- MMM # 20 An Amateur Lunar Telescope Design; Ceramic City;  
Pioneer Quiz: Moon’s surface; Tailings from Mining Operations
- MMM # 26 Prinztion Settlement Design Entry: i. The Rille as a Settlement Site
- MMM # 27 Prinztion cont.: 2. Rille Architecture – General Concepts; Sardine Can Fatalism
- MMM # 28 Prinztion cont.: 3: Three Village Residential Areas
- MMM # 33 Glass–Glass Composites update
- MMM # 37 Ramadas: Yard and Worksite Canopies for Lunar Outposts; Flare Sheds
- MMM # 38 Polders: A Space Colony Model
- MMM # 40 Cloacal vs. Tritreme Plumbing
- MMM # 48 Hostels: Alternate Concept for both First Beachheads and Secondary Outposts,  
1. The Visiting “Amphibious” Vehicle
- MMM # 49 Hostels: 2. The Hostel’s Share of the Workload; 3. Evolution of Hostel with Use
- MMM # 50 Hostels: 4. Hostel–appropriate Architectures
- MMM # 51 Fire Department
- MMM # 52 “Xities” – Settlements Beyond Earth’s Biosphere; 1 Xitytech(nology); Fireside
- MMM # 53 Xity Plans
- MMM # 54 Xity Plans, II
- MMM # 55 Beyond Mole Hill City: Skyscrapers on the Moon; Moon Roofs; Shantytown67
- MMM # 66 Lunar Utilities Infrastructure: Wiring the Moon; Light Delivery Systems
- MMM # 67 Water Reservoirs; Settlement Water Company
- MMM # 74 Housing on the Moon; Shielding & Shelter; Visual Access; Letting in the Sun;  
Drop–in Utility Cores; Modular Element Testbed Ensembles
- MMM # 75 A Successful Lunar Appropriate Modular Architecture
- MMM # 76 Inside Mare Manor; Interior Walls; Wall Surfaces & Trimwork; Wall Hangings;  
Ceilings; Flooring
- MMM # 77 Inside Mare Manor 2. Furniture & Furnishings
- MMM # 80 Avoiding the “Sardine Can Syndrome”
- MMM # 84 Rural Luna: “Tarns” and “Tarnitecture”
- MMM # 88 Shelter on the Moon; Dust Control
- MMM # 90 Site Management; Warehousing
- MMM # 91 Expanding the Outpost
- MMM # 92 Permanent Outposts?
- MMM # 94 The “Middoors” – Making do without the “Outdoors”
- MMM # 95 Mother Earth and Mother Moon: 2 Distinct analogous forms of “Cradle Blanket”
- MMM # 96 Fresh Air; The Quest for Elbow Room; A Green Security Blanket
- MMM # 100 An Early Lavatube Town; Challenges of Sealing & Pressurizing Lavatubes
- MMM # 107 Clear Span Lunar Base Structures
- MMM # 110 “Reclamation” is a Xity’s Charter Function

MMM # 111 Lunar Skyscrapers Revisited  
MMM # 116 A Modular Approach to Biospherics  
MMM # 120 Essence of the Frontier: Readiness to Reinvent Everything  
MMM # 122 Shielding Accessories: the “B” Options  
MMM # 125 A Levittown on the Moon?  
MMM # 127 TransHab and The Architecture & Promise of Hybrid Rigid–Inflatables  
MMM # 131 Improving the Moon: The Developer’s Role  
MMM # 132 Collapsed Lavatube (Rilles) Makeovers; Liquid Airlocks revisited;  
“Skylight Domes” for Lavatube Towns & Vaulted Rilleplexes  
MMM # 134 Lavatubes: The Developer’s Role  
MMM # 135 Cast Basalt: Startup Industry With Two Great Tricks  
MMM # 136 Nightspan Lighting: Sulfur Lamps and Light Pipes  
MMM # 137 Taking Back the Surface: Above Surface Architectures for Moon Habitats  
MMM # 138 The “Black Sky Blues” – Coping with Black Sky Country  
MMM # 145 Murphy Beds and Multi–Function Living Spaces in Frontier Private Quarters  
MMM # 146 Urban Lofts & Settlement Style: 1. A Preview of Lunar Interior Styles  
MMM # 147 More Clues from Loft–living Styles  
MMM # 148 Distributing Risk: Lessons from 911  
MMM # 152 Thermally Self–Regulating Lunar Habitats;  
The Middoors: Being “at Home” is Completed by Being able to go “Outside”  
MMM # 157 “Porches” on the Moon  
MMM # 160 Will Settlement Change the Moon’s Appearance?  
MMM # 166 Designing Surface Structures for Moonscapes  
MMM # 178 Storage on the Moon  
MMM # 179 “Black Sky Blues” and Faux Skylights & Clerestories  
MMM # 187 Cities “Out There” (Xities) – Bringing Home the Difference;  
From Outpost to Settlement: Tell–tale Signals of Passage  
“Bridging” Rille Valley Chasms Before Traffic Warrants Building a Bridge  
MMM # 190 Aluminum (ALONtm) Windows  
MMM # 194 Microwave Oven Technology for Road Building  
MMM # 198 The Outpost Trap: Technologies Needed to Break Free; I. Transportation  
Systems; II. Expansion–friendly Modular Outpost Architectural Language;  
!!!. Locating for Local, Regional, Global Expansion Options  
MMM # 199 The Outpost Trap: IV. In Situ (local) Resource Utilization;  
V. Industrial Diversification Enablers; VI. The Entrepreneurs; VII. Moonbase Personnel  
MMM # 200 The Outpost Trap: VIII. Strategies for Organizations helping make it happen;  
IX. A Lunar Analog Program can Make it Happen  
MMM # 201 “Beyond Our First Moonbase;” Modular Biospherics Living Wall Systems  
MMM # 202 Modular Biospherics: Middoor Green Spaces  
MMM # 204 Modular Biospherics: Toilet–equipped Habitat & Activity Modules  
MMM # 205 Modular Biospherics: Tritreme Plumbing; An Unpressurized Lee–Vac Arena  
MMM # 208 Lunar Settlement has already begun (Apollo’s “Leavings”)  
MMM # 224 An International Lunar Research Park  
MMM # 232 Lunar Base “Preconstruction;” Pete’s Shielding Blog  
MMM # 234 Cast Basalt: Critical Role for Lunar Industrialization, Settlement Construction;  
Basalt: What its availability means  
MMM # 239 An Avatar Moonbase?  
MMM # 242 Telepresence–operated “Robonauts” will revise all “Scenarios;” Role of  
Robonauts & Robots on the Moon Once Humans have settled in to stay  
MMM # 258 Moon and Mars Outposts: Building Sheltering Structures First

## **SUB-THEME INDEX: MMM THEMES: Lunar Architecture & Construction**

**NOTE:** There must be many ways to group the many articles listed above.  
We make no claims that this one is the best, but it may help.

### **Beginnings: “Outposts”**

MMM # 48 Hostels: Alternate Concept for both First Beachheads and Secondary Outposts,  
1. The Visiting “Amphibious” Vehicle

MMM # 49 Hostels: 2. The Hostel’s Share of the Workload; 3. Evolution of Hostel with Use

MMM # 50 Hostels: 4. Hostel-appropriate Architectures

MMM # 84 Rural Luna: “Tarns” and “Tarnitecture”

MMM # 198 The Outpost Trap: Technologies Needed to Break Free; I. Transportation  
Systems; II. Expansion-friendly Modular Outpost Architectural Language;  
!!!. Locating for Local, Regional, Global Expansion Options

MMM # 199 The Outpost Trap: IV. In Situ (local) Resource Utilization;

V. Industrial Diversification Enablers; VI. The Entrepreneurs; VII. Moonbase Personnel

MMM # 200 The Outpost Trap: VIII. Strategies for Organizations helping make it happen;  
IX. A Lunar Analog Program can Make it Happen

MMM # 208 Lunar Settlement has already begun (Apollo’s “Leavings”)

MMM # 224 An International Lunar Research Park

MMM # 232 Lunar Base “Preconstruction”

MMM # 239 An Avatar Moonbase?

MMM # 242 Telepresence-operated “Robonauts” will revise all “Scenarios;” Role of  
Robonauts & Robots on the Moon Once Humans have settled in to stay

### **Shielding Against Radiation and Thermal Extremes**

MMM # 1 M is for Mole

MMM # 3 M is for Mounds

MMM # 17 Liquid Airlocks

MMM # 37 Ramadas: Yard and Worksite Canopies for Lunar Outposts; Flare Sheds

MMM # 38 Polders: A Space Colony Model

MMM # 55 Beyond Mole Hill City: Skyscrapers on the Moon; Moon Roofs; Shantytown

MMM # 74 Housing on the Moon; Shielding & Shelter

MMM # 88 Shelter on the Moon; Dust Control

MMM # 107 Clear Span Lunar Base Structures

MMM # 110 “Reclamation” is a Xity’s Charter Function

MMM # 111 Lunar Skyscrapers Revisited

MMM # 122 Shielding Accessories: the “B” Options

MMM # 132 Collapsed Lavatube (Rilles) Makeovers;

“Skylight Domes” for Lavatube Towns & Vaulted Rilleplexes

MMM # 137 Taking Back the Surface: Above Surface Architectures for Moon Habitats

MMM # 152 Thermally Self-Regulating Lunar Habitats;

MMM # 166 Designing Surface Structures for Moonscapes

MMM # 232 Lunar Base “Preconstruction;” Pete’s Shielding Blog

MMM # 258 Moon and Mars Outposts: Building Sheltering Structures First

MMM # 26 Prinztown Settlement Design Entry: i. The Rille as a Settlement Site

MMM # 27 Prinztown cont.: 2. Rille Architecture – General Concepts

MMM # 52 “Xities” – Settlements Beyond Earth’s Biosphere; 1 Xitytech(nology)

MMM # 74 Housing on the Moon; Visual Access; Letting in the Sun

MMM # 95 Mother Earth and Mother Moon: 2 Distinct analogous forms of “Cradle Blanket”



## **The Concept of the Middoors**

- MMM # 5 Lunar Architecture; M is for Middoors
- MMM # 8 Animal Life; Parkway
- MMM # 94 The “Middoors” – Making do without the “Outdoors”
- MMM # 96 Fresh Air; A Green Security Blanket
- MMM # 152 The Middoors: Being “at Home” is Completed by Being able to go “Outside”

## **Modular Biospherics**

- MMM # 40 Cloacal vs. Tritreme Plumbing
- MMM # 75 A Successful Lunar Appropriate Modular Architecture
- MMM # 96 Fresh Air; The Quest for Elbow Room; A Green Security Blanket
- MMM # 116 A Modular Approach to Biospherics
- MMM # 148 Distributing Risk: Lessons from 911
- MMM # 201 “Beyond Our First Moonbase;” Modular Biospherics Living Wall Systems
- MMM # 202 Modular Biospherics: Middoor Green Spaces
- MMM # 204 Modular Biospherics: Toilet-equipped Habitat & Activity Modules
- MMM # 205 Modular Biospherics: Tritreme Plumbing; An Unpressurized Lee-Vac Arena

## **Outfitting Lunar Homes**

- MMM # 20 An Amateur Lunar Telescope Design
- MMM # 51 Fire Department
- MMM # 66 Lunar Utilities Infrastructure: Wiring the Moon; Light Delivery Systems
- MMM # 74 Housing on the Moon; Visual Access; Letting in the Sun; Drop-in Utility Cores; Modular Element Testbed Ensembles
- MMM # 76 Inside Mare Manor; Interior Walls; Wall Surfaces & Trimwork; Wall Hangings; Ceilings; Flooring
- MMM # 77 Inside Mare Manor 2. Furniture & Furnishings
- MMM # 80 Avoiding the “Sardine Can Syndrome”
- MMM # 96 Fresh Air; The Quest for Elbow Room; A Green Security Blanket
- MMM # 136 Nightspan Lighting: Sulfur Lamps and Light Pipes
- MMM # 145 Murphy Beds and Multi-Function Living Spaces in Frontier Private Quarters
- MMM # 146 Urban Lofts & Settlement Style: 1. A Preview of Lunar Interior Styles
- MMM # 147 More Clues from Loft-living Styles
- MMM # 157 “Porches” on the Moon
- MMM # 190 Aluminum (ALONtm) Windows

## **Lunar “Xities”**

- MMM # 2 M is for Metropolis
- MMM # 5 Lunar Architecture; Matchport
- MMM # 26 Prinztion Settlement Design Entry: i. The Rille as a Settlement Site
- MMM # 27 Prinztion cont.: 2. Rille Architecture – General Concepts; Sardine Can Fatalism
- MMM # 28 Prinztion cont.: 3: Three Village Residential Areas
- MMM # 38 Polders: A Space Colony Model
- MMM # 52 “Xities” – Settlements Beyond Earth’s Biosphere; 1 Xitytech(nology); Fireside

MMM # 53 Xity Plans  
MMM # 54 Xity Plans, II  
MMM # 91 Expanding the Outpost  
MMM # 92 Permanent Outposts?  
MMM # 100 An Early Lavatube Town; Challenges of Sealing & Pressurizing Lavatubes  
MMM # 120 Essence of the Frontier: Readiness to Reinvent Everything  
MMM # 125 A Levittown on the Moon?  
MMM # 187 From Outpost to Settlement: Tell-tale Signals of Passage

## **Building Materials**

MMM # 3 Building a Concrete Outpost  
MMM # 16 Glass-Glass Composites  
MMM # 20 Ceramic City  
MMM # 33 Glass-Glass Composites update  
MMM # 20 Tailings from Mining Operations  
MMM # 135 Cast Basalt: Startup Industry With Two Great Tricks  
MMM # 234 Cast Basalt: Critical Role for Lunar Industrialization, Settlement Construction;  
Basalt: What its availability means

## **Utilities**

MMM # 17 Liquid Airlocks  
MMM # 40 Cloacal vs. Tritreme Plumbing  
MMM # 66 Lunar Utilities Infrastructure: Wiring the Moon; Light Delivery Systems  
MMM # 67 Water Reservoirs; Settlement Water Company  
MMM # 90 Site Management; Warehousing  
MMM # 132 Liquid Airlocks revisited;  
MMM # 178 Storage on the Moon

## **Construction Opportunities for Private Enterprise**

MMM # 16 Glass-Glass Composites  
MMM # 17 Liquid Airlocks  
MMM # 18 Strategy For Following Up Lunar Soil-Processing With Industrial M.U.S.-c.l.e.  
MMM # 20 An Amateur Lunar Telescope Design; Ceramic City;  
Pioneer Quiz: Moon's surface; Tailings from Mining Operations  
MMM # 37 Ramadas: Yard and Worksite Canopies for Lunar Outposts; Flare Sheds  
MMM # 48 Hostels: Alternate Concept for both First Beachheads and Secondary Outposts,  
1. The Visiting "Amphibious" Vehicle  
MMM # 49 Hostels: 2. The Hostel's Share of the Workload; 3. Evolution of Hostel with Use  
MMM # 55 Beyond Mole Hill City: Skyscrapers on the Moon; Moon Roofs; Shantytown67  
MMM # 66 Lunar Utilities Infrastructure: Wiring the Moon; Light Delivery Systems  
MMM # 74 Shielding & Shelter; Visual Access; Letting in the Sun;  
Drop-in Utility Cores; Modular Element Testbed Ensembles  
MMM # 76 Inside Mare Manor; Interior Walls; Wall Surfaces & Trimwork; Wall Hangings;  
Ceilings; Flooring  
MMM # 77 Inside Mare Manor 2. Furniture & Furnishings

MMM # 80 Avoiding the “Sardine Can Syndrome”  
MMM # 88 Shelter on the Moon; Dust Control  
MMM # 90 Site Management; Warehousing  
MMM # 91 Expanding the Outpost  
MMM # 94 The “Middoors” – Making do without the “Outdoors”  
MMM # 107 Clear Span Lunar Base Structures  
MMM # 116 A Modular Approach to Biospherics  
MMM # 120 Essence of the Frontier: Readiness to Reinvent Everything  
MMM # 122 Shielding Accessories: the “B” Options  
MMM # 134 Lavatubes: The Developer’s Role  
MMM # 135 Cast Basalt: Startup Industry With Two Great Tricks  
MMM # 136 Nightspan Lighting: Sulfur Lamps and Light Pipes  
MMM # 137 Taking Back the Surface: Above Surface Architectures for Moon Habitats  
MMM # 138 The “Black Sky Blues” – Coping with Black Sky Country  
MMM # 145 Murphy Beds and Multi-Function Living Spaces in Frontier Private Quarters  
MMM # 146 Urban Lofts & Settlement Style: 1. A Preview of Lunar Interior Styles  
MMM # 147 More Clues from Loft-living Styles  
MMM # 157 “Porches” on the Moon  
MMM # 166 Designing Surface Structures for Moonscapes  
MMM # 178 Storage on the Moon  
MMM # 179 “Black Sky Blues” and Faux Skylights & Clerestories  
MMM # 190 Aluminum (ALONtm) Windows  
MMM # 194 Microwave Oven Technology for Road Building  
MMM # 201 Modular Biospherics Living Wall Systems  
MMM # 202 Modular Biospherics: Middoor Green Spaces  
MMM # 204 Modular Biospherics: Toilet-equipped Habitat & Activity Modules  
MMM # 205 Modular Biospherics: Tritreme Plumbing; An Unpressurized Lee-Vac Arena  
MMM # 224 An International Lunar Research Park  
MMM # 232 Lunar Base “Preconstruction;” Pete’s Shielding Blog  
MMM # 234 Cast Basalt: Critical Role for Lunar Industrialization, Settlement Construction;  
Basalt: What its availability means  
MMM # 239 An Avatar Moonbase?  
MMM # 242 Telepresence-operated “Robonauts” will revise all “Scenarios;” Role of  
Robonauts & Robots on the Moon Once Humans have settled in to stay  
MMM # 258 Moon and Mars Outposts: Building Sheltering Structures First

## Miscellaneous

MMM # 3 M is for Mare/Maria, Multiple Sites  
MMM # 18 Strategy For Following Up Lunar Soil-Processing With Industrial M.U.S.-c.l.e.  
MMM # 20 Pioneer Quiz: Moon’s surface  
MMM # 127 TransHab and The Architecture & Promise of Hybrid Rigid-Inflatables  
MMM # 131 Improving the Moon: The Developer’s Role  
MMM # 134 Lavatubes: The Developer’s Role  
MMM # 138 The “Black Sky Blues” – Coping with Black Sky Country  
MMM # 160 Will Settlement Change the Moon’s Appearance?  
MMM # 179 “Black Sky Blues” and Faux Skylights & Clerestories  
MMM # 187 “Bridging” Rille Valley Chasms Before Traffic Warrants Building a Bridge  
MMM # 194 Microwave Oven Technology for Road Building

## Foreword to this Volume on Lunar Architecture & Construction

As you can see from perusing the Index above, many aspects of designing and building Lunar Settlements are covered. It will be, after all, a complex undertaking, and as such, it will fail if we do not plan to “cover all the bases.”

While we could have arranged the material into logical “chapters,” it seemed more productive to present the relevant articles gathered here in chronological order – the order in which they were written. That way, the reader will grasp the evolution of ideas and concepts involved, and newer ideas will escape the fate of being presented before older ones.

The reader will quickly see that we have gone well beyond all previous treatments of how people from Earth can actually settle the Moon and go on to make themselves quite at home. Failure to reach that level of comfort and life-satisfaction in what until now has seemed to be a totally alien environment, would inevitably lead to the collapse of the effort, rendering the Moon as a hostile world of future ruins at best.

Most writers today concern themselves with what it might take to establish a basic “outpost” as a center of operations for scientists and explorers on the Moon for temporary tours of duty. Some go on to imagine an installation as big and complex as the McMurdo Sound base in Antarctica, which hosts a few thousands of personnel during the Antarctic Summer, and a sizable skeleton crew over the winter, but no permanent residents, no families, no children, no real “homes.”

To many, to realize something as large on the Moon as the McMurdo Sound outpost (you can't call it a settlement) is all we dare hope for, and we'd be lucky to see such a development a hundred years from now. That is a failure of vision that has many roots

✓ We are stuck with a space transportation system that is totally inadequate for the job, based on quaint paradigms such as throwaway stages, direct to the Moon without refueling, no use of fuels produced on the Moon, minimal use of lunar resources to help bootstrap the operation, and so on.

✓ “In Situ” (“On Site” or “On Location” for those of us who prefer talking in English rather than Latin) Use of local (Lunar) resources, means for many, just oxygen production. We need to be able to produce building and manufacturing materials from the elements abundant on the Moon: special alloys of iron, aluminum, titanium, and magnesium; lunar concrete; glass-glass composites; basalt in hewn and cast form as well as basalt fibers and basalt fiber composites.

✓ We need to predevelop adequate shielding technologies

✓ We need to develop a lunar transportation system that creates depots and garages and shelters along a network of roads: We do not yet have a high enough resolution vertical contour map to aid us in planning easily negotiable road networks

✓ We are stuck like moths gathering at a street light to the concept that the availability of polar ice means that the poles are the only place worth siting a moonbase, when, beyond water ice, perhaps the most critical and industrially fundamental lunar resource is not iron or aluminum but basalt, which needs little processing to produce a plethora of basic products but is to be found only in the maria, the dark lunar plains that cover 39 % of nearside.

✓ And as to the poles, the North Pole is much more advantageously situated in proximity to the maria than the South Pole, and the North Pole appears to have double the water ice endowment as the South Pole

✓ Too much of the planning is being done by those who only want to explore and gather geological knowledge.

✓ Too little of the planning is being done by those who want to settle the Moon and leverage its resources to create a booming economy that supplies badly needed products for use in Low Earth Orbit and in Geosynchronous Earth Orbit.

✓ To this end, we have also published a Theme Issue on “The Lunar Economy” ✓ This issue also complements those on “Lunar Tourism,” “Lunar Arts and Crafts,” “Eden on Luna,” and one planned to cover “Lunar Surface Activities.” **Enjoy!**

Peter Kokh

## MMM #! – December 1986



**ABOVE: "TerraLuxe"** – a unique underground home in the Kettle Moraine Hills region 25 miles NW of Milwaukee, Wisconsin. A tour of this home in May 1985 sparked the "thinking outside the Molehill box" brainstorm exercise that gave birth to the Moon Miners' Manifesto newsletter late the following year, still published 25+ years later.

**"M" is for Mole** by Peter Kokh

**Forward:** There follows the introductory and only essay article in the first issue of Moon Miners Manifesto, dated December 1986, shortly after the founding in Milwaukee of what was then the Milwaukee Lunar Reclamation Society L5, a chapter of the L5 Society advocating settlements in space after the inspiration of Gerard K. O'Neill.

This piece is about the historical roots of the inspiration behind MMM. Herein lies the personal "eureka" that gave birth to the chain of thought that continues throughout many articles in MMM through the present; **That we can make ourselves at home on the Moon.**

**M" is for "mole"** – That is what many people, even some prominent space advocates, think settlers of the Moon are going to be. Yes, lunar habitats and facilities will be covered by some 2–4 meters (6–13 feet) of lunar soil or "regolith." While such a shielding overburden is necessary for longterm protection from cosmic rays, solar flare outbursts, and the sun's ultraviolet rays, this does not mean that we "moon miners" can't take the glory and warmth of sunshine down below with us!

A year ago this Spring, May 1985, in following up on an ad in The Milwaukee Journal's Sunday Home Section, I went to see a marvelous place called "TerraLuxe" [ Latin: "Earth Light" ] in the Holy Hill area twenty-some miles northwest of Milwaukee. Here, architect-builder Gerald Keller (appropriately, German for "cellar") had built a most unusual earth-sheltered or underground home.

Run-of-the-mill underground homes are covered by earth above and on the West, North, and East, while being open and exposed to the sun along the South through a long window wall. But Mr. Keller's large 8,000 sq. ft. home was totally underground except for the North-facing garage door. Yet the house was absolutely awash in sunlight, more so than any conventional aboveground house I had ever been inside. Sunlight poured in through yard wide circular shafts spaced periodically through main room ceilings. These shafts were tiled with one inch wide mirror strips. Above on the surface, an angled cowl followed the sun across the sky



from sunup to sundown at the bidding of a computer program named "George" (undoubtedly of "let-George-do-it" fame). **Note:** in the more recent photo below, the movable cowls have been replaced by fixed curved skylights.

Even more amazing, through an ingenious application of the periscope principle on the scale of picture windows, in every direction you could look straight ahead out onto the surrounding countryside, even though you were eight feet underground. I felt far less shut in than in my own Milwaukee bungalow.

TerraLuxe was built as an idea house and my tour cost \$4. This home would make an ideal group field trip tour, but unfortunately, it is now privately owned and not shown on request

Of course, Mr. Keller's ingenious ideas to bring down below both sunshine and view, would have to be adapted to lunar building conditions. I have no doubt that they could be. Mr. Keller told me that he had drawn up plans and blueprints for a whole city using his principles. Someday, I'd like to see them. If the streets and byways of his city were similarly built in a sun-drenched pressurized underground conduit, so one could leave one's lunar home and go anywhere throughout the settlement without putting on a spacesuit, why, it'd be better than living in the Milwaukee I love! – Peter Kokh, November, 1986. **MMM**

This article is online at: [www.moonsociety.org/chapters/milwaukee/mmm/mmm\\_1.html](http://www.moonsociety.org/chapters/milwaukee/mmm/mmm_1.html)

**Note:** The photo above was taken on the morning of October 15, 2002, 17 years later. Visible are the exterior panes of 3 periscopic picture windows, and several skylights. The originals had mirrored cowls following the sun across the sky, resetting position each night. More than eight ft of soil covers the home

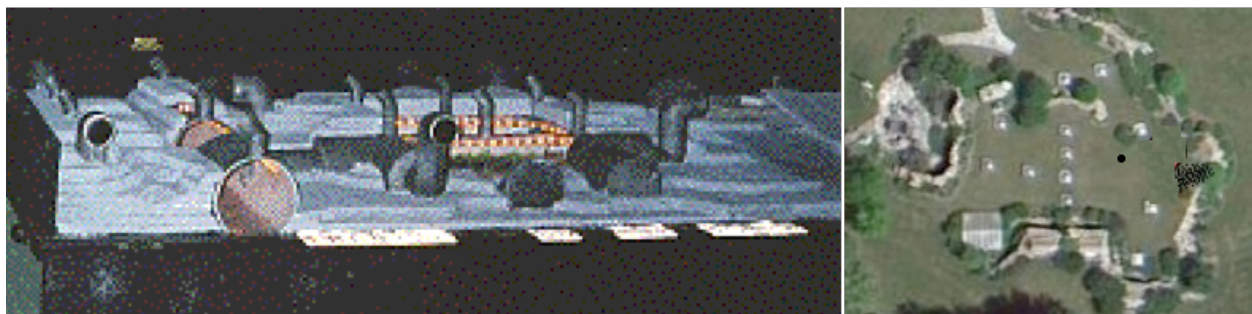

**Left:** 36"x80" table top "lunar homestead" model uses Keller's ideas. **Right:** overhead view of Terra Luxe

Homestead diagram is at: [http://www.moonsociety.org/chapters/milwaukee/mmm/moonmanor\\_plan.gif](http://www.moonsociety.org/chapters/milwaukee/mmm/moonmanor_plan.gif)

### Imagineering in the spirit of Terra Luxe

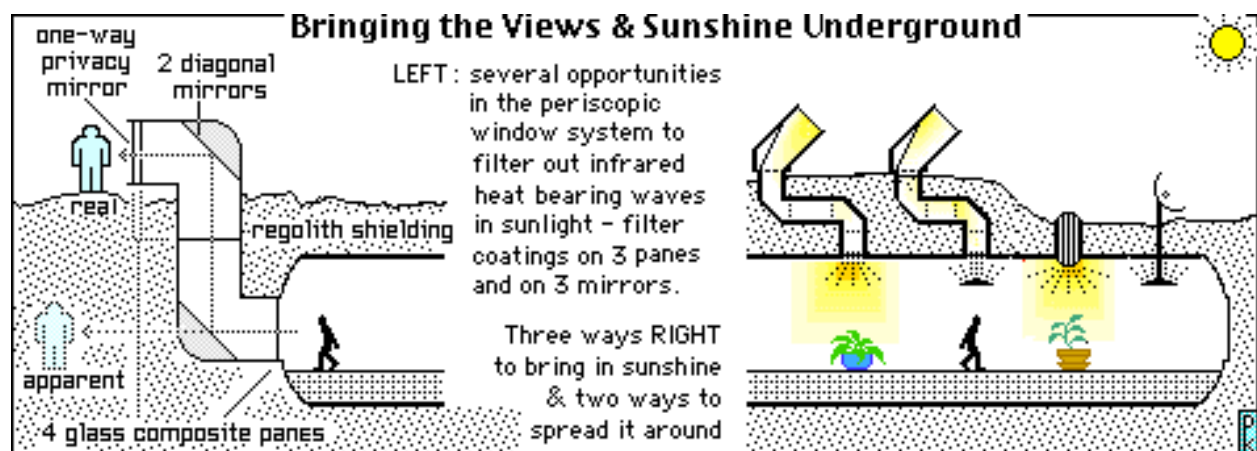

A cutaway Table Top "Moon Manor" Lunar Homestead display, inspired by Terra Luxe, was designed and built for the 1998 International Space Development Conference exhibit hall (with further elaborations)

## MMM #2 – February 1987

### M IS FOR METROPOLIS:

It has been estimated that it takes a community of about 250,000 minimum to provide all the various goods and services in a diversified economy to be substantially independent of imports. When anyone speaks of their belief that a Lunar or Martian settlement of a few hundred persons can be autonomous, they are either being naive or are defining autonomy loosely. Such a small settlement might achieve 50–60% self-sufficiency, but a metropolis of a quarter million could be 95% self-sufficient. No wooden nickels, please! Let's go for broke or quit kidding ourselves. MMM.

## MMM #3 – March 1987

### ESSAYS IN "M":

#### Mare/Maria – Multiple Sites – Mounds

By Peter Kokh < [kokhmmm@aol.com](mailto:kokhmmm@aol.com) >

**M is for MARE, PL. MARIA** (MAH-ray, MAH-ri-a)

The large dark areas on the Moon, the so-called Lunar Seas, formed three to four billion years ago when most of the large impact basins filled with layers of a very low viscosity lava and cooled. Some such basins on the Farside of the Moon did not fill with lava and are called "Thassaloids" (from the Greek word for sea).

While an initial Lunar Base might be built just about anywhere, once more extensive settlements are built, the maria are clearly preferable. The regolith, the loose surface material, composed of rock fragments and soil, which overlies consolidated bedrock, has a very variable thickness in the highlands, from zero to 30 meters. On the mare, however, the **regolith** has a more uniform depth of about 10 meters, which makes construction easier. While Lunar concrete relying on calcium rich highland soil and **upported** hydrogen will be a lot cheaper for initial base construction than pre-built modules brought from Earth, once a lot of construction is planned, even that method will be too costly. The only way to go is site-extrusion, building the structures from the fused soil on the site itself. Mare soils melt 200C ( 360F ) lower than highland soils and so will require significantly less energy either in fusing rammed soil or in making panels of cast basalt. The melt's lower viscosity will also help in some applications.

The levelness of the mare surface will also be an asset to laying out any extensive settlement. And importantly, the average atomic number and weight of mare soils, as compared to highland soils, makes them preferable for shielding against cosmic rays, etc.

But the best mare sites will be just "offshore" so to speak, so that highland soil, richer in aluminum and calcium, will also be available for manufacturing and processing. Finally, such a site will offer more scenic and recreational interest.

[Articles in later MMM issues call for "coastal" sites, in the spirit of this last paragraph.]

### M IS FOR MULTIPLE SITES:

One settlement a world does not make! Of course one must start with a single site, and it will be able to serve most of the initial needs. But no site has all the assets. Soils differ not only from highland (or "**terrae**") to mare but also from mare to mare and even within a given mare. Different materials are available to the prospective processor or miner at such sites as crater and rille walls, the central peaks of some large craters, and the so-called dark mantle deposits.

Some polar areas might have **permashade** fields of frozen volatiles like ice and carbon oxides. Some sites will be especially scenic. Locations along the limb between nearside and farside "**librate**": the Earth will alternately be just above and just below the horizon -- anyone want to build the first Lunar Honeymoon Resort? An observatory dedicated to the Great Andromeda Galaxy, M31, could be built in the north, while a similar installation in the south could concentrate on the Magellanic Clouds. Farside would be best for observation of the Milky Way and for giant radio telescopes and SETI searches, etc.

### M IS FOR MOUNDS:

The first impression anyone will have of a Lunar Settlement will be that of a complex of mounds, the two–four meter (six–thirteen foot) overburden of Lunar soil used as thermal insulation and cosmic ray shielding. The downward pressure of this much lunar soil per square inch is much less than the upward pressure of the air inside the habitat. So this blanket of soil does not present a stress upon the habitat(s). You can look at this blanket of dust as an analog of the blanket of air which protects you could freeze out Earth's atmosphere, it would provide a light snowy blanket about 15 feet thick. **MMM**

The above essay is online at; [www.asi.org/adb/06/09/03/02/003/mare-essay.html](http://www.asi.org/adb/06/09/03/02/003/mare-essay.html)

## Making Concrete on the Moon & Building a Concrete Outpost

Peter Kokh reports on a visit by Dr. T. D. Lin

Dr. T. D. Lin, a native of Taiwan, is now living and working in this country for Construction Technology Laboratories in Skokie, Illinois wants to build a lunar base out of concrete. He appears to have done his homework. In connection with the Portland Cement Association, Lin approached NASA and received a small amount of Apollo sample return moon dust for an experiment in making concrete using lunar materials.

Since the sample was too small for more than one test, Lin experimented with lunar highlands soil **simulant**, rich in aluminum and calcium, to prepare his "cement" and using raw simulated regolith in place of sand and aggregate to mix in to make his batch of concrete. It worked fine.

Once he had the experiment down pat, he tried it using the real thing. Combining water, cement, and 1.4 ounces of moon dust he produced a one inch cube of concrete that proved to be considerably stronger than our garden variety terrestrial concrete.

"We measured its compressed strength at 10,971 psi, compared to 7,900 psi for a comparative sample of conventional concrete. Since the minimum standard for a reinforced concrete slab is 4000 psi, the results were very encouraging." Lin believes the angular shape of most particles that make up the lunar regolith -- they have never been exposed to weathering by wind or water -- help create the stronger bond.

Now on the steering committee of the Lunar Development Council (LDC), whose logo is a crescent moon with a steam shovel poised on the bottom cusp, Lin has designed a large concrete lunar base. At 210 feet in diameter the three floor round concrete structure would provide 90,000 square feet with all of the materials coming from the Moon, except for 55 tons of hydrogen which would come from Earth. In addition to the cement to be processed from highland regolith, raw local regolith would be used for shielding as well as for aggregate.

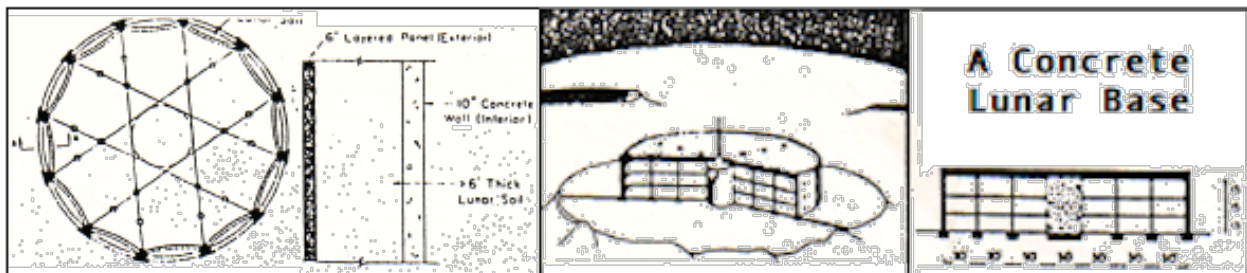

The walls of each floor would consist of 12 convex sections tied together by a crisscross maze of cables under tension. As concrete is stronger under compression than it is under tension, the 10" thick convex panels work, in combination with the cable stays. An outer wall of 6" thick concrete, not under pressure would provide a surrounding bay to be filled with a minimum of 6' of regolith shielding, more piled on the roof. Iron extracted from the soil would be processed not only into the tension cables but into H-shaped connectors joining the convex panels forming the inner pressure wall and the concave outer panels holding in the regolith shielding.

So instead of taking to the Moon a collection of Earth-made modules to assemble into a prefab ready-to-do-nothing outpost, with good intentions of someday working towards some early industrial projects, Lin's group would start with lunar industry, enough of it to process cement, his steel cables and panel connectors, his concrete wall, floor and roof panels, etc. The outpost itself would be the first project

This is a radically opposite approach from all others we have come across. The LDC base, once finished would be just the beginning as everything would be in place to make additional pressurized structures. You have to wonder if Lin's approach isn't the better one, that everyone else has the cart and the horse mixed up. This approach seems tailor made for a turn-key approach. LDC would build the Moonbase and then turn it over to NASA or a comparable operator who could then concentrate on operations: prospecting, exploring, and science experiments..

At 90,000 square feet, equivalent to a square one floor structure 300" on a side, this one structure would provide plenty of space for early expansion, far more room than any other proposal for a starter outpost.

Lin has also expressed a desire to repeat his experiments with simulated Mars soil. And he thinks he can cut down the amount of water (i.e. of imported hydrogen) needed if planned experiments to create concrete by steaming the ingredients instead of soaking them work as he expects.

**MMM**

NOTE: The **Lunar Development Council's** organizing effort failed and the effort was abandoned within a year.

## MMM #5 - May 1987

# LUNAR ARCHITECTURE

By Peter Kokh - LUNAR ARCHITECTURE

[Fourth in a series of articles on the need to pre-develop the "Software" for a Lunar Civilization]

Through the years, a variety of suggestions have been made for the erection of the First Lunar Base. Most common is to make use of fully prefabricated shelters (such as space station modules or re-outfitted space shuttle external tank) imported from Earth and / or a low-Earth orbit (LEO) space station and burying these in the Lunar soil. A less expensive method of erecting a base of similar limited scope is Dr. Lowell Wood's plan (of Project Columbus) to use inflatable kevlar (carbon fabric) bags (air pressure would be more than enough both to inflate them and to support the overburden of protective soil).

Construction techniques may seem to be a HARDWARE question. But what is built on the Moon will depend \_entirely\_ on the philosophy behind our presence there. Without the right SOFTWARE of purpose, nothing significant will happen.

The stated purpose of most lunar base proposals seems shortsighted: to serve as a base for doing Lunar Science (Selenology, but the lazier term Lunar Geology is in vogue) and for mining engineers tending a largely automated operation. A word about Lunar Science. Few laymen perhaps have as high a "selenology curiosity quotient" as the writer, but science is properly the function of a living community already in place. Many would-be Lunar Scientists want only to titillate their own curiosity and then go home.

But our purpose has to be different: to make the Moon a second human world. Science in the long run -- much, much more of it -- will follow naturally, science done not by visitors from Earth but by people who have adopted the Moon as their new home.

The type of small prefabricated initial base described above makes better sense as a construction shack for a much larger facility to be built with as high a percentage of native Lunar materials as is initially possible. T. D. Lin's proposed 90,000 square ft, three level, 210 ft diameter concrete structure might be ideal (see the sketches on the last page of MMM #3) in which 55 tons of terrestrial hydrogen is called for in comparison to 250 tons of Lunar steel, 1500 tons of Lunar highland cement, over 10,000 tons of Lunar soil used as aggregate, and over a million tons of soil used as shielding. [see illustration on page 8]

If expansion is to be an afterthought, it will end up being a forgotten dream. Such a truly Lunar base might be large enough to support open-ended goals of developing non-token Lunar agriculture, pilot materials processing industries, and production-scale 100% Lunar sourced building materials and construction / erection equipment and methods. If (expansion is to be an afterthought, it will end up being a forgotten dream (and you can carve that quote in marble). The only base it is worth building on the Moon is one whose function it is to prepare the methods and tools needed to expand into a full blown settlement.

Only if we make it possible for several thousands (not dozens) of people to live on the Moon from generation to generation (not just through short tours of duty) can we:

- (1) develop a Lunar economy that is truly full and autonomous
- (2) develop a genuinely Lunar human culture and civilization to express and unfold potentialities hidden in humanity since the dawn of time ("Be all that you can be")
- (3) say truly, that the human presence on the Moon is more than that caricature we find in Antarctica and that we have securely established humanity beyond Earth. Only then will we begin to cut the umbilical cord that ties us to the womb world.

So Lunar Architecture, or "LunArchitecture", must be a charter function of a bona fide base. Considerations flowing from the goal make several things clear.

### **1. Speed of "labor-light" construction is essential.**

To begin with, "Lunarchitects" must develop a system that can provide shelter at a pace sufficient to house settlers as fast as the growing Lunar market / trade / economy can absorb them. This means that not even lip service can be given to the time-honored slow, labor intensive housing construction methods. What is important is to build secure shelter as simply and quickly as possible -- let us be so bold as to aim at one per day per crew!

There is a place for labor-intensive, artful, craft-rich, proud work, and that is in the leisurely discretionary finishing of interiors. This can be do-it-yourself or contracted on a pay-as-you-go basis, etc. and can be stretched out over years or even generations. We'll thus employ the analogs of brickmasons and carpenters for interiors, but they have no place in erecting the pressure shells of Lunar indoor / "middoor" spaces.

### **2. The "Dirt Cheap" Goal**

The pressure shells of buildings must be literally dirt-cheap. One cannot "live off the land" nor "sleep under the stars" on the Moon. The place for flaunting affluence is in interior finishing. To keep the basic construction "regolith-cheap" two things are necessary: extrusion of the shelter from the site itself and the use of the least amount of construction energy necessary to do the job well.

### **3. The Concept of the Lunar "Great Home"**



The "right to ample living space" ought to be "religiously" pursued, unammendably, unpostponably. Add-on space will be difficult, risky, and expensive. All the pressurized shell-volume that even an extended family might want should be provided at the outset. Young families might make a "cozy place" in only a part of this and slowly grow into the rest. Included should be solarium and garden space large enough to provide a respectable fraction of their food needs and to help to keep their air fresh as well as provide an oasis of serenity and delight. Another bonus of this "right to ample space" approach would be the availability of in-home areas for starting entrepreneurial cottage industries.

It is necessary then to purge the mind of the facile but inappropriate examples of the prefabricated space station habitat module. Even if manufactured on the Moon, they would be more energy intensive in their construction and almost guarantee a stiflingly stingy allotment of sardine space in turn for the ever unfulfilled promise of more spacious quarters "when the settlement can afford it."

A limited amount of technological homework has already been done along lines that would enable the realization of the goals just outlined. We already know that the Lunar soil can be compacted and then sinter-fused with a mobile magnetron, a high-power microwave generator (the idea of Tom Meeks of the University of Tennessee). This would be ideal for road surfaces, floors, and exterior walls set into excavations in the soil. We know that the soil can be melted into cast-basalt slabs ideal for interior partitions and roof segments, with the balance of the excavated soil being replaced on top as shielding while the interior is being pressurized. We know how to build safe periscopic Lunar picture windows (see MMM #1) and heliostats to flood the interior with sunshine.

But much work needs to be done. Using imported epoxy resins as sealers would be prohibitive. At the least, the natural glass-like glazing of the cast and sintered surfaces may well reduce the need for sealant to joints. In the temperature stable Lunar underground environment with no vibration to worry about from wind or occasional mini moonquakes, and no water-table-induced settling to worry about, this sealant may not need to be as flexible as one might think. Perhaps glaze patching would do the job. On site experiments will be needed to prove out these ideas and build production-capacity equipment.

The scandal of totally unnecessary cost multipliers built into the present establishment approach has discouraged many, leading them to settle for the little dream, the token base, in the false hope that it is a foot in the door. We must not be sheepish about insisting on the Big Dream, our only chance! **MMM**

## ESSAYS IN "M": Middoors – Matchport

by Peter Kokh [kokhmmm@aol.com](mailto:kokhmmm@aol.com)

**FOREWORD:** On the Moon, exiting an airlock in a space suit is something that architecture and engineering will both seek to make as unnecessary as possible. This for two reasons. First the high Lunar vacuum ( $10E-12$  torr daytime facing the solar wind,  $10E-14$  torr nighttime sheltered from the solar wind) is a precious industrial and scientific resource especially in combination with the Moon's substantial gravity. Opening airlocks for exit or entry and purging atmosphere into the vacuum, if done frequently enough, will degrade the vacuum to a point that the solar wind can't restore through its flushing action. Second, the nitrogen used as a buffer gas and biogenic ingredient in the colony's atmosphere must be imported and therefore must be conserved. Making up for preventable losses could well tax the colony's capacity for growth.

### **M IS FOR MIDDOORS:**

On Earth we have been familiar with the distinction between indoors and outdoors for many thousands of years. In the last two decades or so, a new environment, the middoors, has become familiar to most of us in the form of the enclosed, climate-controlled streets and plazas of many a shopping mall.

The "landscaped", sunlit central atrium in some new hotel and office buildings offers another kind of model.

In Lunar cities, except to enter and exit those (e.g. industrial) facilities which for safety's sake must keep their air unmixed with that of the city at large, it will be possible to go most anywhere without donning a space suit. Homes, schools, offices, farms, factories, and stores will exit, not to the airless, radiation-swept surface, but to a pressurized, soil-shielded, indirectly sunlit grid of walkways, residential streets, avenues, and parkways, parks, squares, and playgrounds.

While the temperature of traditionally indoor places could easily be maintained at "room comfort" levels, that of the interconnecting middoors of the city could be allowed, through proper design, to register enough solar gain during the course of the long Lunar day (dayspan), and enough radiative loss during the long nocturnal period (nightspace) to fluctuate 10 degrees F on either side, for example from 55-85 degrees F during the course of the month. "The Great Middoors" could be landscaped with plants thriving on this predictable variation. This would be both invigorating and healthy for people, plants, and animals alike, providing a psychologically beneficial monthly rhythm of tempered mini-seasons. Of course the middoors could also be designed to keep a steady temperature. But oh how boring that would be!

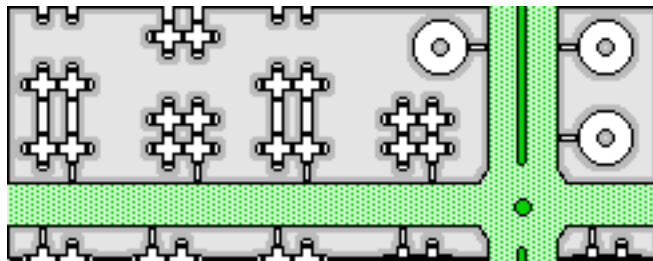

**Section of a neighborhood:** individual homes open onto pressurized "middoor" streets hosting the bulk of the settlement's modular biosphere and vegetation.

### **M IS FOR MATCHPORT:**

To go from one Lunar city to another, or from the city to the space port or other out-lying installations, or to transfer from one vehicle to another, all vehicles and city docks or marinas will be equipped with standardized matchports or interlocks. These will probably be of unisex design rather than male-female, and with either able to do the necessary aligning for safety's sake (although there will undoubtedly be protocols). When the two match-ports are aligned and locked (vehicle-vehicle or vehicle-city), the narrow -- hopefully less than 1 cm -- vacuum gap will be slightly over-pressurized allowing port doors to unseal and open easily inward (into vehicle, into city).

Prior to disengagement, the port doors closed, the narrow inter-door gap would first be flushed with pure oxygen and then this would be pumped out (into vehicle, into city) to provide a low grade vacuum which would seal both port doors by internal pressure (vehicle, city) allowing the vehicle to pull back its matchport and depart, with the escape to the outdoors of only a minuscule amount of cheap oxygen -- no precious nitrogen would escape.

There would probably be three common matchport sizes: for personal surface vehicles, for public surface transports, and for cargo rigs. Outside of safety drills held periodically, perhaps most Lunans will live and travel widely about the Moon without ever putting on a spacesuit. It won't be necessary.

**MMM**

The above article is online at: [www.asi.org/adb/06/09/03/02/005/airlockessay.html](http://www.asi.org/adb/06/09/03/02/005/airlockessay.html)

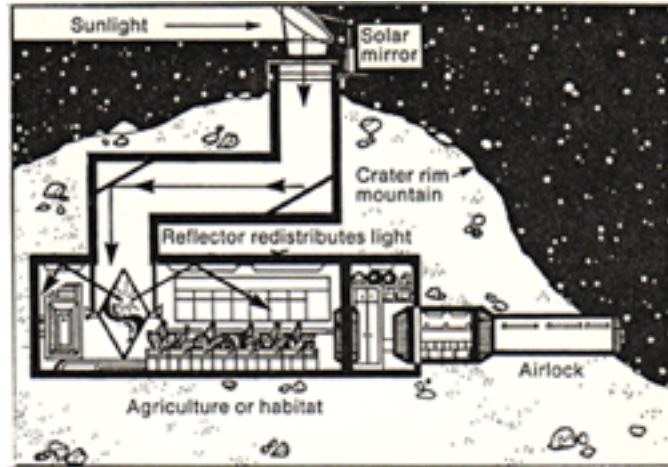

**UNDERGROUND POLAR HABITAT:** Sunlight piped in from heliostat. L. Ortiz/NASA. As drawn, this would work if the Moon's axial tilt were zero. In fact it is 1.5° and to be able to catch the sun's rays at all times of the month, the heliostat would have to be on a tower at least 2,000 ft. above all surrounding terrain. If the habitat were not at the exact pole, the tower would have to be even higher. So much for a nice idea. Of course, if there is a handy mountain peak at the pole or a crater rim to catch sunlight most of the month, this might work. MMM

MMM #8 – Sept 1987

# PARKWAY

PARKWAY: Pressurized Greenways within Lunar Towns

[Sixth in a series of articles on the need to pre-develop the SOFTWARE of a Lunar Civilization]

By Peter Kokh

## City Planning Considerations

Some months back, Myles Mullikin, the current Milwaukee Lunar Reclamation Society chapter president, and I got into an interesting discussion on how a lunar settlement, more than a mere Moonbase, might be laid out. Myles favored a strictly linear one street city, or at least a single arterial spine, on the grounds that experience with computer architecture showed that this was the most efficient type of layout.

However, even if it means, as Myles pointed out, more atmospheric volume and hence more tonnage of precious imported nitrogen, I tend to favor some sort of grid system for two reasons. First it enhances physical networking, allowing people to interconnect over shorter distances; but especially since the extra total length of streets per given population would provide the opportunity to plant extra living biomass. The more of this biomass per person, the stronger will be the life-support flywheel for air and water purification, etc.

## The Parkway's Role in the Biosphere and ideal plant species for Parkways

Parkway streets and avenues, pressurized and shielded but with solar access, could host such non-foodstuff plantings as pharmacopeic (medicinal) species; plants

useful for preparation of natural cosmetics; plants whose extract can be used to dye cotton, like indigo and henna; plants to support a carefully chosen "urban wildlife"; and last but not least, flowering and blossoming plants to support honeybee colonies [perhaps an Australian stingless species].

Such a utilitarian selection (and here is where the software pre-development homework comes in) will do double duty by refreshing the air outside agricultural areas of the settlement and at the same time providing a delightful and luxuriantly green "middoors" environment (see MMM #5, Essays in 'M') in which the settlers can go about their daily business in the reassuring context of "nature".

### **Ambience**

There could be special fruits for the children to pick in assigned season. Sidewalk cafes could grow their own special salad and desert ingredients on location. Care for street-side plantings could be left in the hands of neighborhood residence and/or business associations who could landscape to their desire, providing the opportunity for each neighborhood to have its own unique ambience.

### **The Parkway Climate**

MLRS member Louise Rachel in her article in last month's special premier Moon Miners' REVUE issue entitled "Some Preliminary Considerations for Lunar Agriculture", reminded us that many of the temperate zone plants we are familiar with will not grow and reproduce full cycle in a climate in which the temperature never falls to a cold enough level to reset them. This means the settlement's parkway streets will have to be planted with mostly subtropical species and varieties. In the continental U.S. there is only one major city whose climate lies exclusively in our proposed lunar middoor range (55 – 85 ° F) -- San Diego. If you have ever been to this jewel of a city and noticed how different is the local vegetation where you live, you'll get the idea.

### **The Parkway Ecosystem**

We need to know not only what will grow under such conditions but what sort of ecological relationships must be maintained. What animal species are required for pollination, etc.? Should we let some varieties in the lunar community, which will tend to sow themselves and find their own balance, or pick only those over which we can keep tight control? Which plants will need how much care? Above all, which can we import not as seedlings or mature plants but as nitrogen-packed seeds to make sure there are no stowaways? What trees can be grown in dwarf varieties? There is so much we have to learn and the homework can begin now, even by educated laymen, maybe by you!

**MMM**

The original article is online at: <http://www.asi.org/adb/06/09/03/02/008/parkway.html>

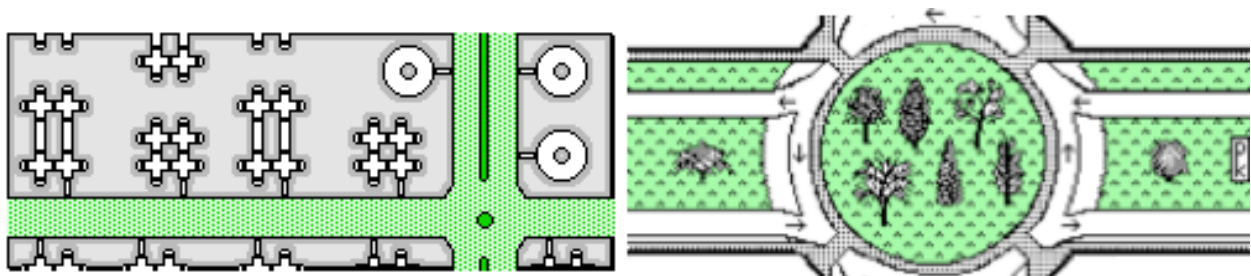

**The "Middoors" as the key Biosphere Component**

In a modular settlement, allowed to grow as need be (not a fixed size megastructure based on someone's guesstimate of future needs), modular habitats and other structures are connected to pressurized residential/commercial "streets." These "commons" contain the bulk of the settlement's biomass and biosphere.

**MAY #16 - JUNE 1988**



## **GLASS GLASS COMPOSITES**

By Peter Kokh

Glass-glass-composites, more exactly glass-fiber / glass-matrix / composites, or simply GGC, are a promising new horizon for construction and manufacture. This new bird in the flock of materials available to man is still inside the eggshell but pecking away at it. What we know of GGC's promise we owe to Dr. Brandt Goldsworthy of Goldsworthy Labs in San Francisco, who at the request of Space Studies Institute in Princeton (SSI) made laboratory-sized samples and investigated their properties (his report is available for 3\$ from Space Studies Institute, PO Box 82, Princeton NJ 08540). His work gives reason to believe that GGC building materials will be as strong as steel or stronger, and considerably less costly in energy terms to manufacture.

The occasion for this bit of incubation of a theoretical hunch lies in careful analysis by SSI of the possibilities of producing serviceable metal alloys from the common ingredients in lunar soil. While the Moon is rich in iron -- some of it free uncombined fines -- and other important metallic elements such as aluminum, titanium, magnesium, and manganese, these are just starting points; to make alloys with good working properties, other ingredients in lesser amounts must be added. It turns out that our customary and familiar stable of alloys used on Earth often require recipe ingredients that are not easily or economically isolated from the soil. Furthermore, alloy production takes a great deal of energy and therefore represents a technology direction for a very advanced lunar civilization, and not one for an early base trying to justify its existence with useful exports to LEO or elsewhere. Alloys will come on line someday; it will take young metallurgists without defeatist attitudes ready to scrap Earth-customary alloy formulations and experiment from scratch with available elements until they have a lunar-appropriate repertoire which will serve well. But that is another story. Here we want to explore the tremendous potential of GGCs.

### **A "Spin-Up" Enterprise Plan**

But how can we explore the potential of a laboratory curiosity? We can't. Are we to wait until we get to the Moon and then fiddle around, hoping that we come up with something before the base has its next budget review? You would think so from the present dearth of activity.

Why not haul GGC out of the lab and put it through its paces in the real world? Sure that takes money, but with a little imagination it is easy to see that GGC could become a profitable industry, here and now, on good old Cradle Earth. And if so, our newly acquired expertise and



experience will be ready to go whenever the powers that be establish a long-term human foothold on Luna.

What is the realistic market potential that would justify the effort and expense of getting off our bottoms and pre-developing this promising technology now? If we are talking about something only useful for industrial construction material, then the threshold for successful market penetration is high. Our GGC products must come on-line either cheaper than every competing material or have such superior properties as compared to existing alternatives as to force potential customers to take the gamble. But to limit ourselves, especially at the outset, to such a line of products is not only accepting unnecessary barriers to success, it evidences a great lack of imagination.

Does GGC have a potential for consumer products? This is an important question, for with such products cost can be secondary to other considerations such as visual appeal due to inherent special design and style possibilities, etc. The consumer market could be a much easier nut to crack, and once established and experienced there, our infant industry would be better poised for market entry in the industrial-commercial world.

Before we speculate further, we must take a look at this intriguing new material and put it through the paces to see what we can and can't do with it. Without that, we are building castles in the sky.

We have a logical plan of attack for these experiments thanks to the analogy of GGC to a long familiar family of materials with which we have abundant experience: fiberglass reinforced plastic resin composites, the stuff of which we make boat hulls, shower stalls, pick-up toppers, whirlpool spas, corrugated porch roofing, and a host of other handy products. Fiber reinforced plastics or FRPs offer the game GGC entrepreneur a handy agenda for exploring the talents of the new material.

First our enterprising hero will want to see what fiberglass-like fabrication methods GGC is amenable to mimicking. Can (or should) the still hot and workable glass matrix with glass fibers already embedded be draped over a mold to take its form, or be compression molded in a die and press? Can (or should) the glass fiber be set in the mold and then impregnated with the molten glass matrix? (The magic of GGC lies in using two glass formulations: one with a higher melting point from which to make glass fibers, and one with a much lower melting point to serve as the matrix in which the reinforcing fibers are embedded.) Can (or should) the glass fibers be first impregnated with a cold frit of the powdered glass that will form the matrix upon heating in the mold to its fusing point? Once the entrepreneur has learned which fabrication methods work best or can be adapted to the idiosyncrasies of GGC in various test formulations, he is ready for the next round of experimentation.

Fabricating a "piece" of GGC of a certain useful size and shape is only the first victory. We must learn how to machine it: can the material be sawed, drilled, routed, tapped, deburred, etc.? We need to know this before we can design assembly methods. If adhesives are to be used, what works best? Thermal expansion properties of GGC formulation will be important, as well. Once our entrepreneur has done all his hands-on homework, knows what he can do with this new stuff, and has outfitted his starter plant with the appropriate machinery, tooling, and other appropriate equipment, it's time to sit down with his market-knowledgeable partner and decide on product lines.

But let's back up a moment. We said we were going for the consumer market as the ideal place to get our feet wet, and for this market one thing is paramount: visual appeal. So we go back to the lab and start playing around with our formulations. Glass of course is easily colored. Coloring the matrix glass will not provide us with a distinctive product. But colored glass fibers in a transparent glass matrix suggest tantalizing possibilities. The fibers could lie in random directions, be cross-hatched or woven, swirled, or combed to give an apparent grain. We will want to see which of these suggestions are most practical, which have the most stunning and distinguished consumer eye-appeal, etc., all without compromising the strength

of our material. As to the colors: black, green, brown, blue, cranberry, and amber would give us an ample starter palette. But before buying up binfulls of the needed ingredients we could do some inexpensive footwork, using abundant and inexpensive green and brown bottle glass for our fibers to give us a first feel for likely results of this avenue of product enhancement. Our homework done, we're ready to burst onto the world scene.

Our recycled long-empty plant (the rent is cheap and a lease wasn't necessary) has been humming for a while now. Production hasn't begun because the designers are still working on the molds and dies for the introductory product line. Buyers and outlets are being lined up. At last Lunar Dawn Furniture Company is ready to greet the unsuspecting world. At first we produce only (stunning of course) case goods: coffee and end tables, etageres and book cases and bedroom sets, etc. Then we introduce a line of tubular patio furniture that makes the PVC kind look gauche. Next we branch into an upholstered line with beautiful external frames. Office furniture, striking unbreakable fluted glass lamp shades, stair and balcony railings, and unique entry doors are our next targets. Our prices are somewhat high at first, at least with the initial lines, but we were the rage at the fall furniture show in North Carolina and the spring Home Shows in every town. Lunar Dawn takes it's place beside Early American, Mediterranean, Danish Modern, and Eighteenth Century English.

We introduce less expensive but still appealing lines and franchise our operations, targeting especially the less developed nations that need to curtail their forest-razing and which have an abundance of the raw materials needed for glass making. But we also begin to diversify into the commercial and industrial markets. We've learned to make beams and panels and now offer a whole line of architectural systems for competition with steel and aluminum pole buildings, etc. One of our branches is now marketing GGC conduit and pipe at competitive prices. Another is offering a full range of clear non-laminated safety glass for buildings and vehicles.

Meanwhile, we are not resting on our laurels in the consumer world. Casings for small appliances, cookware, ovenware, and table ware; handles, wash basins, and countertops; boat hulls for boulder-studded white water use; all are now available in GGC. A big hit with the fans is our indestructible flagship in the sports world, our GGC bodied Demo Derby Dragon. The same car has won its first dozen events and looks none the worse for it.

Of course, we've long since abandoned the cumbersome GGC or Glass-Glass-Composite tags. The public got what it needs, a simple one syllable pigeonhole. We're known and recognized everywhere as GLAX, a word suggesting glass with a difference: strength. And visually, the "ss"-replacing-"x" even suggests the dual composition involved. Glax is a generic term like steel or wool and even has its own generic logo, a symbol for public recognition and promotion.

You'll see in the logo symbol an allusion the Moon. For the ulterior motive inspiring the people behind the successful Glax entry into Earth markets was the need to predevelop a technology suited for early lunar bases and settlements. Glax will provide a relatively inexpensive, uncomplicated industry for the settlers both to furnish badly needed exports, and just as important, a whole range of domestic products that will help hold the line on imports. As such, Glax is an essential keystone in the plan to achieve economic viability and autonomy for the projected City.

There is a lot of enthusiasm on Earth now, not just for a lunar scientific outpost à la Antarctica, but for a genuine settlement. This change of attitude did not happen by accident, and the story of Glax on Earth played a major role in this turn of events. Glax, since the first door-opening day of Lunar Dawn Furniture Company, was aggressively marketed as an anticipatory lunar technology. The public began to get the idea that moon dust might be good for something and that the idea of a self-supporting settlement relying largely on its own resources was not a flake notion, but rather something reasonable, even to be expected! Lunar Dawn helped the process along when after moving into its brand new plant in suburban Milwaukee, it built a simulated lunar home next door, soil-sheltered and all, with solar access,

periscopic picture windows, ceramic, glass, and metal interior surfaces, and of course furnished with its own Glax furniture lines. The habitat was accessed by "pressurized walkway" from the meeting hall–display room–library–computer network room and gift shop built alongside and used free of charge by Milwaukee Lunar Reclamation Society.

How did this all happen? Notice the fine print on Lunar Dawn ads and billboards (also used in connection with other Glax product companies): it reads "An Ulterior Ventures Company". Ulterior Ventures isn't some big conglomerate but a unique venture fund which the National Space Society helped to organize to give entrepreneurs willing to predevelop anticipated lunar technologies for Earth markets, a little help to get started. Successful members of the Ulterior Ventures family pay a royalty which helps build the fund for even more ambitious exploits. In future articles we hope to tell you about other successful -- if not so well known -- members of the Ulterior Ventures family.

### **Future Fact or Science Fiction?**

Fiction? Yes. Unrestrained flight of fancy? No! This is the sort of thing that could happen with NSS encouragement, if the society can be persuaded to show the same enthusiasm for direct action as it always has for indirect agitation "to make it happen". Having to start from scratch to build the infrastructure to incubate and support such "ulterior ventures" would mean an unwelcome set-back in time, effort, and personal energies.

The brand new infant industry sketched above does not require expertise in preexisting sophisticated technologies to get started. Almost any of use could get in on the ground floor of such an endeavor in one or more capacities. Any takers? -- Peter Kokh May 1988



**Left:** a proposed "logo" for any future **Glass-Glass Composites** industry

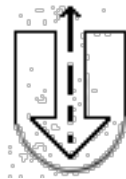

**Right:** Logo for the Ulterior Ventures Fund suggested in the previous article on Glass Glass Composites. The larger downward arrow, for the terrestrial applications that support the research and development, give rise to the upward arrow, putting "on-the-shelf" technologies that will be needed on the lunar and space frontiers. Interest and/or royalties on venture funds will support further ventures.

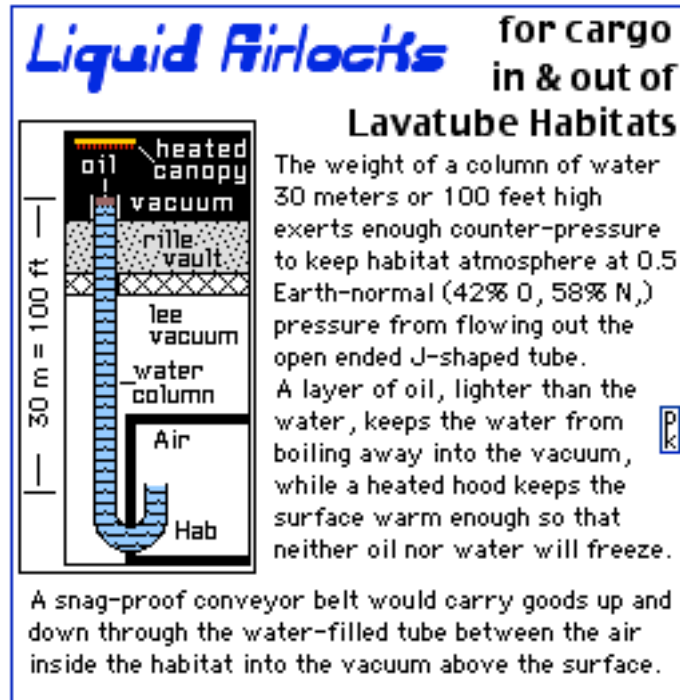

## INDUSTRIAL USE VACUUM-PRESSURE TRANSIT OF PRODUCTION ITEMS IN FULL OR PARTIAL GRAVITY, WITHOUT VENTING OF AIR

By Peter Kokh

While many take a cavalier and could not-care-less attitude toward the preservation of lunar vacuum -- a precious industrial and scientific asset -- and seem thoughtless of the expensive non-conserving lifestyle which continuously vents costly import nitrogen through routine, frequent airlock cycling, this author finds both attitudes unacceptable and presents an alternative airlock-system to handle some important categories of traffic between pressurized and non-pressurized areas.

On the Moon or other airless bodies or in free space, where vacuum is already provided, a "barometric column" of a suitable liquid and of appropriate height, will seal in the atmospheric pressure of a habitat, factory, or warehouse via a U or J shaped tube.

**AIR BAROMETER:** a device for measuring atmospheric pressure. The average atmospheric pressure at sea level is 1 atmosphere which is the pressure that will support a column of mercury (Hg) 760 mm (76 cm or 29.92 in) high. This corresponds to the pressure exerted by a column of air about 5 miles (8km) high if its density were constant and equal to that at sea level. If a long glass tube which is sealed at one end and open at the other is filled with mercury and then is stood upright with the open end downwards in a dish containing mercury (or in a U-shaped tub open at one end) then so much mercury will flow out of the tub (or up the other, open end) until a column of mercury 760 mm in height above the level in the dish (or in the upturned open end of the tube) remains. The space above the mercury in the closed end of the tube is vacuum and contains no air. From: THE WAYS THINGS WORK, AN ILLUSTRATED ENCYCLOPEDIA OF TECHNOLOGY, Simon and Schuster, 1963. Page 220.

A continuous loop conveyor provided with the appropriate grip/release system with one end in the external vacuum, the other in the internal pressurized environment, will allow transit on a production basis without the venting of air (nitrogen and/or oxygen) such as occurs in the conventional vestibule-type cycling airlock, an early classic of science-fiction and still taken quite for granted by most writers, both technical and non-technical alike. (For Shame!)

**Entry and Exit of "Routine Items" into/out of pressurized environments**

Such a liquid barometric seal could become standard on the Moon (and, for example, on spoke-and-wheel shaped free space settlements) to allow entry and exit of routine items. For entry into pressurized environments, we think not so much of imports (from Earth or other settlements) -- these can be taken care of by "match port" docking -- as of those items which it is useful or efficient to manufacture in a vacuum but which will be used in the interior of the settlement. Metal and glass items are possible instances.

For exit, we think not so much of exports of items manufactured in pressurized environments and intended for use within other settlements -- or vehicles -- as of items so manufacture intended for use in vacuum. Of both categories (candidates for entry or exit) there should be several if not many instances. Very real losses of nitrogen, especially, but also of oxygen, can be avoided and vacuum degradation prevented, by the employment of such a liquid airlock system in well chosen cases. Two problems must be discussed.

[1] The first problem is the availability of a suitable "barometric" liquid. Such a liquid should be fluid over a wide range of temperatures so that its utility is not constrained. A relatively high specific gravity or density would be a plus because it would proportionately shorten the required sealing column. It should have a low vapor pressure so that the rate at which it evaporates into the vacuum is slow enough to represent a substantial savings over the continual nitrogen loss that would result from the alternative reliance on a conventional cycling airlock system. Its cost of acquisition, by upport from Earth or by lunar sourcing should again be lower than the cost of the nitrogen conserved over the lifetime of its use.

[2] Finally, such a liquid should be relatively inert, not corroding or otherwise adversely affecting either the items carried through it or the conveyor that carries them. It should drip off the exiting parts easily, both in vacuum and in air.

### **Candidate Liquids**

Three possibilities suggest themselves. The first is Mercury (Hg), the densest choice by far. However, it is highly unlikely that mercury can be lunar-sourced. The cost of its upport must be added to that of its acquisition (purchase), and very large volumes of it will be needed, the cross-section of these industrial-scaled liquid airlocks being orders of magnitude larger than that of barometers and thermometers. Finally, mercury has a highly toxic reputation -- well-earned -- that would require very special handling on both ends. Despite its high specific gravity, we can pass over this choice.

The second choice is Gallium (Ga) which before its expected discovery was referred to as eka-aluminum. This element is very scarce but widely distributed on Earth in zinc blends and bauxite. Traces of it have been found in lunar soils, but it may be some time before it can be extracted economically in the quantities required for this prospective use which would be in competition with its desired service in gallium arsenide photocells for solar arrays (more efficient than the far cheaper silicon). Which usage would be more strategically important, I am not prepared to guess.

The credits of gallium are considerable. It is liquid from 30.1 °C – 1983 °C (86 °F .. 3601 °F) -- a very serviceable range for lunar and free space environments and industrial conditions -- and has a very low vapor pressure. Its specific gravity as a liquid is 6.081 (times as dense as water), which is very attractive, if somewhat less than half that of mercury. Of its inertness and benignness, I would not know.

The third choice is NaK (pronounced "knack"), a eutectic liquid alloy so-called from its constituents: sodium (Na) 23% and potassium (K) 77%. NaK, unlike its constituents, is liquid from a temperature not much higher than room temperature to about 800 °C -- again a highly serviceable range. Its thermal capacity is high. This, together with its expected economical lunar-sourcability will make it the industrial coolant of choice (instead of water/steam) for many lunar applications, possibly nuclear reactors among them. Against its cheapness as compared to other choices, Hg and Ga, must be balanced its low density or specific gravity which is comparable to that of water. This means that for its use in a barometric sealing liquid



airlock system, the necessary column must be six times that of a system using gallium, and nearly fourteen times that of a system using mercury.

Nonetheless, while far from ideal, such high columns are still within the realm of practicability. Given the importance of the strategic goals (conserving nitrogen and preserving vacuum), all else considered, NaK is the logical choice. Possible showstoppers are its degree of inertness or lack thereof, of which I am ignorant, and the evaporation rate in vacuum, of which again I know nothing. As to its density, suffer a layman's naiveté to suggest experimenting with solutions of NaK and sodium disulfide or potassium disulfide, which might raise the value to a more practical level.

**HEIGHTS OF BAROMETRIC SEALING COLUMNS IN VARIOUS GRAVITY AND PRESSURE SITUATIONS.**

(The height is shown in meters with foot' and inch" equivalent given in parentheses)

Gravity: Earth-like situation (1.0 g)	Gravity: Mars-like situation (0.38 g)
Pressure: 1.0 ATM      0.5 ATM	Pressure: 1.0 ATM      0.5 ATM
Liquid	Liquid
Hg 0.76 (29' 9")      0.38 (15' 0")	Hg 2.00 (78' 7")      1.00 (39' 4")
Ga 1.74 (58' 5")      0.87 (34' 2")	Ga 4.58 (15' 0")      2.29 (7' 5")
NaK 10.33 (33' 9")      5.17 (17' 5")	NaK 27.18 (89' 0")      13.59 (44' 5")
Gravity: Moon-like situation (0.16 g)	
Pressure: 1.0 ATM      0.5 ATM	
Liquid	
Hg 4.56 (15' 0")      2.78 (7' 5")	
Ga 10.44 (34' 2")      5.22 (17' 1")	
NaK 62.00 (203' 0")      31.00 (101' 7")	

Note the extra incentive (besides the 63% savings in nitrogen supports) that the lower column height in 0.5 ATM provides (0.5 ATM consisting of 21 parts oxygen and 29 parts nitrogen or 50/100 ATM vs. 1.0 ATM consisting of 21 parts oxygen and 79 parts nitrogen or 100 / 100 ATM). NASA suggests this mixture as quite livable.

**Application on Rotating Structures with Artificial Gravity**

In rotating space structures with artificial gravity, the motivation to preserve the external vacuum disappears, but the economic necessity of conserving nitrogen remains, and the barometric seal liquid airlock will be a wise choice for the appropriate categories of goods traffic. The figures given above are valid to this venue as well. Thus a torus with 1/6th gravity (Moonlike) and 0.5 ATM internal pressure could be outfitted at each spoke with a liquid airlock with one end inside the torus and the other end piercing the ceiling on the side of the spoke and with a 101.7 foot column differential using NaK. This might come in especially handy for parts manufactured inside the rotating settlement for use in adding on to it from the outside. For a full 1.0G 1.0 ATM Stanford Torus, the corresponding column height would be 33.9 feet. The height in both cases seems eminently practical.

For Bernal Spheres and O'Neill Cylinders, liquid airlocks can still be used, but they must creep up the outside of the end caps and will be a mite trickier to use. To my knowledge, no one has discussed the possibility of liquid airlocks for either space settlements or lunar installations.

**Application on Other Airless Worlds**

The applications on other large airless satellites (Io, Ganymede, Callisto, and Europa in descending order of gravity) will be quite similar to those on Luna. But smaller bodies, e.g. Ceres, Iapetus, etc. will require column heights that would seem quite impractical -- many hundreds of feet or more. Economics will determine the cut-off point.

**Engineering Challenges**

The second problem -- for those of you waiting for the other shoe to drop -- is that of inventing (and patenting) the appropriate conveyor system with a grip / release system that

probably must be design-specific for each type of production-line ware making the transit inwards or outwards. As we are dealing with a system open to vacuum on one end, the whole must be as thoroughly service-free as possible and operate without snags or jams. Here is where this neat idea must descend from the head-in-the-clouds abstract to the nuts-and-bolts concrete. The liquid airlock idea may be patentable in itself, but I doubt it, and the need for the real world experimentation is paramount; hence the lack of hesitation in throwing it out into the public domain.

### **Getting your feet wet -- Experiment!**

For those of you itching to experiment with different liquids and diverse conveyor systems, but requiring the possibility of profits from here-and-now terrestrial applications markets, here are some possibilities to spur on this pre-spin: transit between everyday Earth environments and special atmosphere chambers using pure nitrogen, pure chlorine, pure hydrogen, or other gases; transit into and out of "clean rooms".

Such applications may seem sparse, but I venture they will be deemed important enough -- at least in some high-traffic instances -- to support the costs of research and development necessary. If this is indeed the case, here are avenues of experimentation which will put invaluable experience and knowhow "on the shelf" from where we can take them, at greatly minimized cost and delay, when we need them for space or lunar use eventually. Another important ULTERIOR VENTURE entered into for profit below and ulterior utility above. If we leave it to NASA, It wouldn't get done! It's not a need for a non-industrial outpost such as NASA has limited its vision to include.

MMM

## **MMM #18 - SEPTEMBER 1988**

# **Strategy For Following Up Lunar Soil-Processing With Industrial M.U.S.-c.l.e.**

By Peter Kokh

How can a small settlement (anything less than some hundred of thousands and probably a whole lot smaller) have the most effect industrially? Some "muscle"? Fortunately, we have a clear and precise criterion by which to judge, and it points the way like a beacon: keeping upport tonnage from Earth to a minimum, i.e. making do for as much (mass-wise) of the settlement's needs as possible from local lunar resources. To strive in this direction, the settlement -- while not neglecting any possibilities -- will do well to give top priority to items which, multiplying unit weights by quantity needed, embody the greatest opportunity for savings if manufactured locally.

Among equally weighty categories, those items that require less industrial sophistication and diversification and which are not unreasonably labor intensive would naturally get first attention (e.g. one ton of dishes over one ton of electronics).

Shelter itself, with some parts of utility systems (e.g. pipe and conduit at least), and basic furniture and furnishings made of 'lunacrete', iron and steel, ceramics, glass, fiberglass, and glass-glass composites (glax) are obvious items on the list. Such things should account for most of the settlement's physical plant.

What about sophisticated products: machinery of all sorts, vehicles, electronics, appliances? Too ambitious? Only for the non-resourceful! Consider that every supposedly more involved product is an assembly of parts that often includes a shell, casing, cabinet, body, hull, table, etc. that is less complex and yet often represents a considerable part of the total weight of the item. If such parts were made in the settlement and final assembly done there (the really complicated and sophisticated portions representing the output of any subcontractors being preassembled on Earth in subassemblies as large and as integral as possible) this would hold

down the principally weight-determined support price of everything from major shop tools to telephones to vehicles.

This would mean standardizing the size and interfaces of supported subassemblies, cartridges, chases, etc. to fit the very minimal number of cabinet, casing, and body models, etc. that the small lunar work force could produce. (If the completed item were supported, parts supply would be the only limiting factor on variety). Even so, "standard" cabinets and casings could be made to take varied finishes, textures, and colors.

Now the way we make many items on Earth, especially electronics, would lend itself to this approach. Of course, a central office (on Earth would save lunar manpower from paperwork) would have to coordinate everything, so that only chases and work-trays, etc. that would fit made-on-Luna casings and cabinets would be supported. This should not be hard to arrange on a bid basis.

The weight savings on major appliances in cases in which the settlement is not yet prepared to make more than the housing should be considerable. Many such items could be redesigned so all the sophisticated "works" are in one or a few slip-in cartridges.

By the way, all this reasoning holds just as true if it turns out that the first off-Earth settlements are in free space colonies rather than on the lunar surface. Such settlers would operate under the same restrictions until their numbers are vast enough to support self-manufacture of all their needs. They too will need the right strategy to build industrial "muscle".

Why not vehicles (both surface and intra-biosphere) with the body or coach made on the Moon, designed for easy retrofit of a cartridge-like wiring harness, control panel / dash, and motor (even here major heavy parts could be locally made and designed for ease of final assembly)? The benefits of such a setup would be immense.

To maximize the possibilities for "lunar content" and the ease of final local assembly will require designing such vehicles from scratch with this very goal as utmost priority. In a future article, we will talk about the need for an agency to take the initiative in stockpiling such "cartridge designs" for future lunar need.

Keep in mind that lunar surface vehicles are vacuum-worthy spaceships. So the next step would be Earth-Moon, or rather LEO, low-Earth-orbit to Moon or lunar orbiting depot) ferries of high lunar content (cabin, hold, tankage, etc.) and then even space station modules for LEO and GEO designed for easy snap-in outfitting of "works" from Earth.

### "M.U.S.-c.l.c." a 2-part Acronym

You will have noticed the unusual way we spelled "muscle." For our strategy calls for the: **M.U.S.** (Massive, Unitary, Simple) parts to be made by the settlement and the **C.L.E.** (Complex, Lightweight, Electronic) components to be made on Earth to support up the gravity well and be mated on the Moon (or early space colony).

Here then is the logical formula for giving industrial muscle to the early settlement still too small to diversify into a maze of subcontracting establishments. It is a path that has been trod before. It plays on the strengths of the lunar situation and relies on the early basic industries:

lunacrete, iron-steel, ceramic, and glass-glass composites ("glax").

And not surprisingly, it is the path of lunar development that will produce the most in exports to LEO, GEO, L5 (?), and even Mars.

**MMM #20 - NOVEMBER 1988**

## **AN AMATEUR LUNAR TELESCOPE DESIGN**

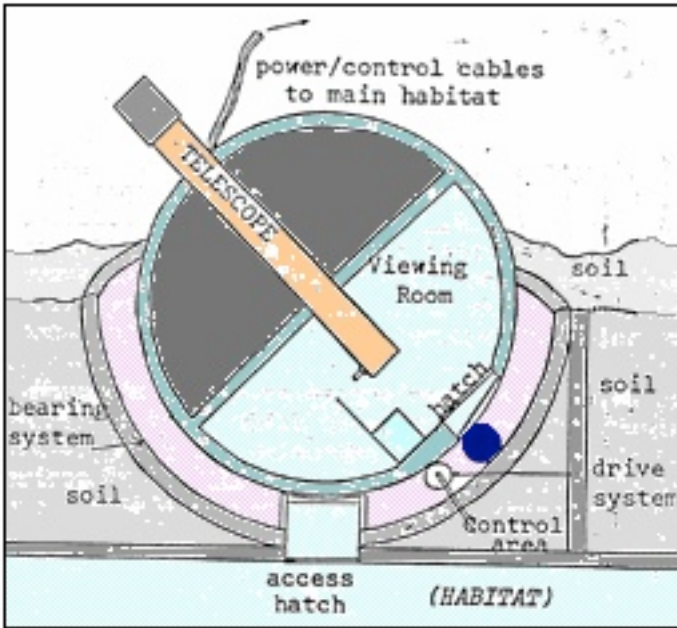

**Amateur Telescope to be used on the Moon, without a spacesuit**

Access to a spherical viewing room is via a hatch in the ceiling of pressurized habitat. Once inside, seated in the chair, the viewing room rotates in directions needed to aim the telescope on the desired target.

Looking through a space suit helmet just would not work! This design is from an MSOE (Milwaukee School of Engineering) student, Ron August, and was the winning entry in a design contest cosponsored by the (Milwaukee) Lunar Reclamation Society and the American Lunar Society in 1988-89.

How would you provide for stargazing in shirt sleeve comfort on the airless Moon?

**Note:** electronic ways to channel a telescope image from a scope on the surface to a comfortable viewing area within a pressurized habitat were not admissible in this “engineering” exercise.

Submitted by Milwaukee School of Engineering (MSOE) student and MLRS member Ron August of Hubertus, Wisconsin. This concept involves a moving, spherical shaped viewing room, with the telescope an integral part of it, that is completely pressurized, heated, and accessible from the habitat below. Entrance to the room is by way of an airtight hatch system.

Once inside the viewing room, the observer will be strapped into a viewing chair which has all controls for movement of the telescope (and viewing room) and focusing of the telescope.

Movement of the telescope/room is achieved by a controller wheel which moves the room into position to point the telescope at anything above the horizon in all directions. The room is suspended by a low friction smooth-running bearing system.

This was the winning design in a competition cosponsored by MLRS and the American Lunar Society. Two other entries received honorable mention, including one in which a zenith-pointing telescope had its base within the habitat, the shaft piercing the regolith shielding overburden and open to the vacuum. The scope turned in a sleeve using a barometric liquid seal and surface mirrors to redirect the view. (see MMM #17 “Liquid Airlocks” above)

**NOTE:** The editor has been well-received by astronomy club audiences over the years for his talk on how future settlers will pursue their amateur astronomy hobby. He has also stressed that through human presence, we will over time learn much more about the planets and moons.

MMM



CERAMIC CITY By Peter Kokh

There are several building materials options for lunar based industry. Among likely candidates for early demonstration are lunar concrete (one part in 224 [per T.D. Lin] represents the hydrogen content of water and will probably have to be supported at great expense,) lunar glass-glass composites, sintered iron, and cast basalt and ceramics. It is this last ceramic option, about which the greatest amount of disinformation exists, some of it in bad faith, the rest simply inexcusable.

A recent book "Space Resources: Breaking the Bonds of Earth" by John S. and Ruth A. Lewis is a case in point. In it, the prospects for lunar development are dismissed with the flippant "what does one do with [brittle] basalt bricks, is a neat question, one that we have been unable to answer." Unfortunately, this book, and this section in particular, received a critically unquestioning review in a recent issue of Spacelines, unintentionally helping to spread the disinformation further.

Enter Nader Khalili, an Iranian with a vision, living in this country, and working around the world. The man is driven by a desire to provide low-, or even no-cost housing for the world's teeming billions. Familiar with Iranian adobe structures, to which there is some resemblance by the far less developed adobe architecture of the American Southwest, he has concentrated on clay and adobe building shapes and styles that lend themselves to being fired and glazed from within to form far stronger, more durable structures than the original unfired ones. His word for this is **Geltaftan** from the Iranian (Persian or Farsi) for "fired structure." His vision then, is a home for everyman, not erected of costly building materials, but fashioned from the native soil of his homesite, in situ [in place, on location.]

Khalili has gone beyond this, however, to experiment with ceramic sidewalks, retaining walls, underground storage tanks, irrigation ditches, etc. all dug/formed on the spot, then fired and glazed. His vision extends to stabilizing eroding cliffs and advancing sand dunes by firing them, to fashioning building slabs and other elements from molten lava fresh from active volcanoes, and to the Moon.

Invited to deliver a paper at the October 1984 symposium Lunar Bases & Space Activities of the 21st Century organized by NASA Johnson and held at the National Academy of Sciences in Washington, DC, his remarks were greeted with enthusiasm by the unsuspecting audience of "experts."

**Let us fast forward to, say, 2020 and read the following letter from a pioneer in his eyes.**

Dear Mom and Dad,

How goes it down there amongst the green hills of Earth? Things are really picking up for me here up grayside.

Today (it's sunrise here on what we optimistically call the "Garden Coast" of Mare Crisium) I began work for Geltaftan-Luna, the settler-owned construction company that is building Port Tanstaaf. At sunrise the company yards came to life as actual construction work depends on concentrated solar energy. During the preceding fourteen days of darkness, workers put together the forms and molds we will use, sifted lunar soil, overhauled machinery, and did other non energy intensive work in preparation for the next two weeks of busy city-building now upon us.

At dawn, the great mold-wheels of assorted diameters and depths were filled with the first of their carefully measured portions of sifted lunar soil. (That's my job - a bit humble, but it's a start!) Then the great solar furnaces come to life concentrating the fire of untamed sunshine and directing it through a heliostat onto the soil charge in the bottom of the mold-wheels. As the charge melts (mare soil, being basaltic, has a very low viscosity and flows freely) and the mold-wheel begins to spin, the born-again magma flows easily over the reinforcing fiberglass mattes (made of nearby highland soil with a 360° F higher melting point) and around the carefully designed and precisely placed plugs that will be openings for doorways, indirect skylights (to be fitted with sun-following heliostats) and even for periscopic picture windows. These openings owe an inspirational debt to the wind-catchers built into ancient Iranian adobe buildings.

The mold-wheels are precision shaped to have a parabolic catenary curve and the resulting fiberglass reinforced cast basalt domes will have maximum strength in compression (from the soil overburden in case of habitat decompression) and tension (from excess air pressure within, not quite wholly compensated by the weight of the soil backfilled above.) The domes have a reinforced inner lip to securely anchor the floors which are fused in place once the domes are erected on their sites.

After the domes and floors have cooled down, the interiors are given a "sodium glaze" closely related to the salt glazing commonly practiced on Earth. The glaze is applied under high heat with first pressurization so that it is really forced into every last pore to make the structure quite airtight. Moldings for hanging pictures or some of those pretty fiberglass tapestries are already built in - you don't dare try to make a nail hole! Some settlers put a sort of lime whitewash over the glaze. Others like the slightly browned (from the sodium) gray tones as they are.

Just as lathe workers learned long ago to produce more than simple turnings, Geltaftan\ -Luna has some very sophisticated mold wheels that turn out tunnel and conduit sections, vaults and apses, and other more complex elements of the modular city-structure. We also make elements that are not turned such as paving slabs, watertight plant bed-bottoms for the farms, shade walls for waste heat radiators etc. And we fuse soil outside all the entrances and airlocks to minimize troublesome soil hitchhiking a ride inside on wheels and boots. While the swiftly multiplying Geltaftan Cooperatives on Earth use basically low-tech methods, here on the Moon, it is all appropriately high-tech or at least precision work. It has to be so, as our environment is mercilessly unforgiving.

The great mold-wheels, are, of course, mobile, advancing with the edge of city construction. But some units are built to move rather quickly, for use outside the city. Next sunth, I get to go out into the field. We will begin constructing a new terminal complex for the spaceport, some thirty miles away, out farther on the mare. Fusing of the new reinforced landing pads was completed last sunth.

In case you wondered how the domes can fit together to make larger structures and the city as a whole, suffice it to say that they best lend themselves to groupings based on a hexagonal grid or honeycomb. Of course this pattern is broken by streets (pressurized, naturally) and cuniculars (pressurized pedestrian walkways or alleys.) Actually, this method of building has a whole consistent language of expression so to speak, and you'd be amazed that the variety of designs Geltaftan-Luna architects have come up with to make the city anything but predictable and boring! Yes, magmitecture, as we call it, is transforming our little corner of the Moon, all from on-site materials, with the result that the city looks (it is!) home-grown, as if it truly belongs here, almost as a native life-form.

By the way, I am studying Lunar Architecture [LunArch IO], to be exact, as a part time student at U of L. It is really a fascinating and exciting new field, and I feel my future here is wide open.

My Marimba lessons are going well. Did you know that the ceramic tubes used in the Marimbas are made by Geltaftan employees in their spare time? This kind of experimental art and craft enterprise is encouraged by the management, and they will even get you whatever tools you need.

Well, Mom and Dad, its been nice chatting but I've got to get to work.

I'll write again soon,

Love,

Graham

## PIONEER QUIZ: The Moon's Surface



## Questions

- [1] What evidence is there to the naked eye that the Moon's entire surface is covered with a fine dust layer on a centimeter (half-inch) scale at least?
- [2] Were any exposed outcroppings of unfractured lunar bedrock spotted by the Apollo astronauts?
- [3] Do we have any idea of the source of the meteorite material that has bombarded the Moon?
- [4] What is the "regolith"? How uniform is it?

## Answers

- [1] The disk of the Full Moon appears to be of similar brightness edge to edge. If the surface was bare rock, the edges would be much darker.
  - [2] Lava flow outcroppings, both massive and thin-bed (less than 1 meter) were spotted in the west slope of Hadley Rille (Apollo 15 mission).
  - [3] All sites show a soil component (1.5–2% by weight) derived from meteorite bombardment with the volatile enriched element abundance characteristic of type 1 carbonaceous chondrites (C1). Signatures of other meteorite classes are rare.
  - [4] Regolith (we predict settlers will abbreviate this to '**lith**') is a continuous debris layer which blankets the entire surface of the Moon from a few centimeters to several meters thickness, and ranging from very fine dust (the portion finer than 1 millimeter being called soil or fines) to rocks meters across. Below this are many meters of fractured bedrock, and finally solid bedrock. About 50% of the regolith at any site originates by impact debris from within 3 kilometers, 45% from 3–100 kilometers, 5% from 100–1000 kilometers, only a fraction of a percent beyond that. About 10–30% of any given maria soil sample is of highland type. Most of the fine pulverizing comes from on-the-spot micrometeorite bombardment, a very slow process taking some 10 million years to thoroughly 'garden' the upper first centimeter.
- [See the article on Lunar Ores on pages 8–9 above and the one on "Tailings" below.]



## Tailings from Mining Operations

By Peter Kokh

**TAILINGS:** (TAY'lings) the residue of any process such as mining. The leavings.

### The Challenge and the Opportunity

Anybody who has ever visited a mining area, has seen the large talus slopes or mounds of pea to acorn sized rubble of unwanted material that announce the approaches to mine openings. This is the chewed up and spit out host material in which the desired ore vein was embedded and which had to be removed to get at the prize. Tailings also refer to the accumulated leavings after the sought after metal is extracted from its ore. As a rule, the volume of tailings is enormously greater than that of the extracted ore. This is especially so with the noble metals, gold, silver, platinum, and copper. In the case of copper, for example, the volume of tailings to metal is typically 100:1.

To the environmentalist without imagination, tailings are a terrible eyesore. To the rare creative environmentalist and would-be entrepreneur, they are instead a vast untapped resource just begging to be put to work.

What is so special about tailings that would justify such a bold statement? Simply this: tailings have already undergone a considerable amount of work. They have already been extracted from the mine site, and are already uniformly ground up into bite-sized pieces often of quite uniform composition. As such they are already preprocessed and represent a substantial energy investment that goes utterly wasted when they are allowed to just sit there scarring the landscape.

In much of the world where rich ore veins exist, paradoxically there is often a scarcity of the traditional building materials. True friends of the Earth would quit wasting time ranting and raving about scenic eyesores and spend their time diligently experimenting with these tailings to see what sort of building materials they could be turned into, putting to advantage the energy investment that has already been made. Alas, creatively enterprising environmentalists are about as common as woolly mammoths.

### **Back on the Moon**

On the Moon, we will find soils richer in this element, soils richer in that element, but likely only in degrees and percentages. While prospecting for especially rich deposits of strategic materials will have its ups and downs, probably more of the latter, basic needs will be able to be met by surface mining of the loose topsoil at almost any coastal site, as such areas have access to both the higher aluminum and calcium rich highland soils and the iron and titanium rich basaltic (lava flow) mare soils of the lunar 'seas'. Among coastal sites, those that also have KREEP (potassium, rare earth elements, phosphorus) deposits will have a special advantage.

The ore company, let's call it Ore Galore Inc. or OGI, will first separate the loose lunar soil or fines into fractions by electrostatic and/or mechanical means. These fractions will then go to various processing facilities dedicated to the production of oxygen, iron, aluminum, titanium, magnesium, glass and glass composites, lunar cement, etc. At the end of each processing line there will be leftover material, tailings. These tailings will often be as rich as the material that undergoes final processing, but will be discarded because they cannot be processed as easily or economically.

Now the principal lunar industries will be concerned with the two most urgent needs, export to pay the bills, and basic shelter: habitat construction. Frills, such as finishing materials, interior (i.e. secondary) building products, furnishings, etc., will have a much lower priority for OGI. The lunar entrepreneur, experimenting in free time if necessary, will have on hand any number of piles of tailings, each probably with some characteristic gross composition resulting from extraction of the different desired elements.

### **Tailings-based Building Materials**

#### **Reusing Spent Energy**

The tailings at the Glax™ (glass-glass-composites) plant will differ from those of the Iron plant or the cement plant etc. We could just leave them there, but considerable energy will then be wasted, the energy which has gone into their sorting and prior scavenging for adsorbed gasses. But the real opportunity that suggests itself is to turn these tailings into various secondary building products meant for finishing and furnishing habitat interiors at the settlers' labor-intensive leisure. These can include decorative panels (glax), tiles for walls and floors, ceramic and glass home wares, special glax compositions for distinctive furniture etc. OGI cannot be bothered with sourcing for such needs but will be only too happy to provide tailings for the taking. Simple opportunism, neighborly and environmentally aware to boot.

Consider the tile-maker. The tailings from the glax plant, when melted and cast, may yield tiles of one characteristic color pattern (very likely variegated), while those from the iron plant may yield another. Aha! variety! interest! choice! – the stuff to whet consumer appetites by allowing personalization and customizing of habitat interiors at leisure once the cookie-cutter pressurized habitat shells have been appropriately mass-produced in the least possible labor-intensive manner. In these various tailing piles lie the seed of incipient lunar entrepreneurialism and small business free enterprise.

The environment-respecting aspect of such products might be advantageously marketed as such to the aware consumer. For example, tiles made from cast tailings might be called 'slaks' (from 'slag').

There will be an especially great demand for coloring agents -- on the Moon that will mean metal oxides exclusively rather than the complex organic dyes made from coal tars etc., that we are used to -- coloring agents for ceramic glazes, stained glass, and special inorganic paints (probably using waterglass, liquid sodium silicate, as a base\*) etc. Some tailing piles may be richer sources of one such colorant or the other. Some sources may be prized for yielding products of special textures or other desirable properties.

**When possible, reserve primary building materials for export products, and tailings-based materials for domestic products**

On the one hand, because of the urgent priorities imposed by the need to justify the infant lunar settlement economically, basic end products such as iron, export quality glass, etc. could well be off limits to the home-improvement product manufacturer. On the other hand, using raw unprocessed regolith or soil may yield only a quickly boring and unvaried product line, and further disturb the surface. Pre-differentiated tailings offer a handy and elegant solution.

**Test of Settlement Industrial Efficiency**

There is perhaps no better single criterion by which to judge a society's environmental impact than the degree to which its material culture uses resources in proportion to their availability. On Earth, our record is abysmal, even amongst cultures which 'live off the land.' We still discard as unwanted too much material after investing precious energy to sort through it for some prized content. If tailings-based building products industries were pursued vigorously here on the home world, there would be far fewer shelterless people in the world, if any, and their homes could be more substantial and satisfying. All it takes is a few people with justified environmental concerns who are willing, to spend more effort in concrete solutions than in raising hell. Complaining is so cheap!

On the Moon, industries should be built up to utilize all the elements present in abundance: with oxygen, silicon, iron, aluminum, titanium, and magnesium, the eventual uses are obvious though requiring different degrees of sophistication. Calcium is the one very abundant element, especially in the highlands, that is most likely to go underutilized. Calcium, of course, is a major ingredient of cement, and Lunacrete, as investigators have begun to call it, is one of the most promising building materials for lunar installations, if and only if a cheap enough source of water, water-ice, or hydrogen can be located and accessed\*\*. If not, the choices will be either to discard calcium with tailing piles being characteristically calcium-rich, or to accept the challenge of finding other ways to put it to use. Whitewash could be one of these.

A lunar administration granting licenses to enterprises might give tax or other incentives to those that are tailings based, to encourage opportunistic usage of material already extracted, rather than allowing additional square kilometers of lunar soil to be mined. This can be done simply by refusing license to mine or use unprocessed lunar soil to manufacture secondary products. Industries should be encouraged to form in a raw materials cascade in which one industry uses for its raw materials the discards of another, until the ultimate residue is minimal or nonexistent. Not only would such a material civilization have the highest standard of living at the lowest environmental impact, it would also use and reuse energy in the most efficient way. Combine this with recycling, and the ultimate test of a mature civilization is one without residue. That is a stubborn goal, so hard to realize that it may seem economic fantasy to some, but one nonetheless worth insistently striving for. The rewards will be great. But above all, on a world where so little is handed to us on a silver platter, only such total use of what we do mine may allow us to beat the economic odds stacked against our success.

Next time you pass a tailings-scaped mining site on some Earthbound highway, stop and take another look. There are fortunes to be made in this unwanted stuff, and preparing for

Moon-appropriate industrial protocols while filling vast unmet needs here below might not be such a bad idea. Now if I were still a young man! **MMM**

\* [Subsequently, we actually experimented with such "paints", producing the first Lunar-style painting in September, 1994] –

[www.moonsociety.org/chapters/milwaukee/painting\\_exp.html](http://www.moonsociety.org/chapters/milwaukee/painting_exp.html)

\*\* [Dr. T. D. Lin has since performed successful experiments using steam instead of liquid water, reporting on this work at ISDC 1998.]

## MMM #26 – JUNE 1989

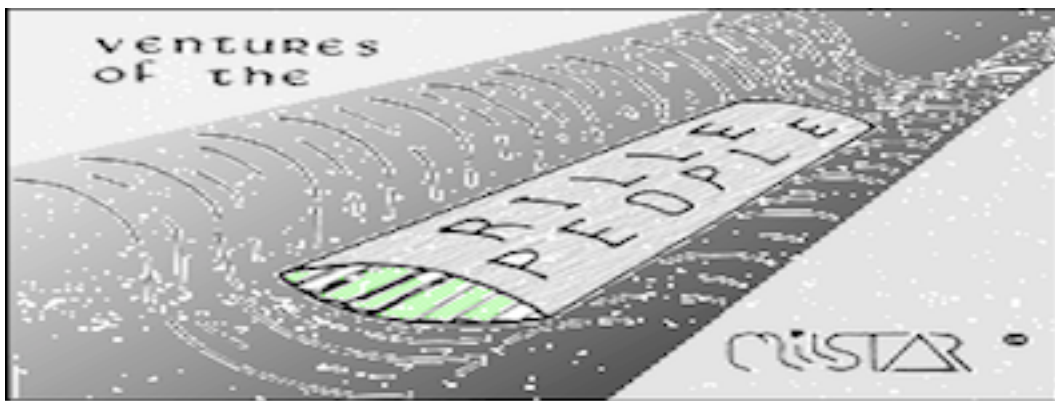

At ISDC 1989 in Chicago over the Memorial Day Weekend, the Lunar Reclamation Society "Think Tank" **MilSTAR** team [**Milwaukee Space Tech & Recreation**] won honorable mention for their design of **PRINZTON**, a 2-tier, 3-village, city in a rille just north of the mare-flooded crater Prinz, 10 km north east of Aristarchus.

Our serialized entry begins here.

# Prinzton

A Rille-Bottom Settlement for Three Thousand People

## Part I: THE RILLE AS A SETTLEMENT SITE

By Peter Kokh

**Rille:** (pronounced rill) [Latin rima, a crack, cleft, or fissure] The origin of the word seems to be a German term for a brook or small stream. Observers of the Moon borrowed it to designate the many straight trenches (likely graben faults) and narrow winding valleys they found. The later, like Hadley Rille, are widely thought to be collapsed lava tubes.

I can remember the days when I used to look upon lunar rilles, great winding valleys hundreds of meters wide and deep and sometimes hundreds of kilometers long, as unfortunate road hazards, obstacles to easy transportation across otherwise flat lunar seas. Every time you plotted a logical route from point A to point B, sure enough there would be some lousy rille that would make it necessary to detour and zigzag or scout out altogether roundabout routes. While I have a lifelong habit of staring apparent obstacles, disadvantages, and liabilities in the face until I see in them some hidden asset worth turning into a trump card, I was slow on this one.

In trying to imagine the Moon as a multi-settlement world, I have repeatedly scouted the maps, photos, and Moon globe for special assets unique to particular sites, giving them *raison d'être* [reason for being] as potential sites for human presence. The Moon is seen by most everyone as a dull monotonous place. But don't let yourself be fooled. The seeds for a diversified and varied human presence are there. Clues abound! Someday I'd like to write a book for amateur observers and armchair dreamers "Looking at the Moon with a Settler's Eye."

### **Nitrogen is the Stickler**

Having plotted, in my mind's eye, a half dozen logical yet uniquely advantaged sites for traditionally conceived cities dug into the surface, I began to look further into the future to a time when one didn't have to be so stingy with nitrogen [Believe it or not, nitrogen for the inert component of air, not hydrogen for water and biomass, nor carbon, will be the most critical and decisive of the Moon's several deficiencies) and could plan a settlement with vista-friendly headroom. And so the idea of covering a rille finally burst in my lethargic brain. Covering a rille valley spanning as much as a kilometer, should not be an impossible engineering feat in lunar sixthweight, where there is no wind to blow and no quakes above an impotent 2 on the Richter scale. Building materials are already on site. But all the tons of nitrogen needed to co-pressurize such a volume! That's the stickler.

I imagined a long sinuous "national park" -- a wildlife refuge in which the then native Lunans could go to gawk and grok, in Schroeter's Valley (not the 15 km wide main valley but the narrow rille within a rille that runs down the center - you need a good photo to see it). Maybe in the 22nd Century something like that would be possible.

Meanwhile, more modest structures could be built in rilles. Why? Because rilles have sides! It's as simple as that. Rilles have sides, that would otherwise have to be human-built. Why, a rille is an excavated foundation just waiting for construction!

In "**Welcome to Moonbase**" by Ben Bova (1988, Ballantine), Eagle Engineering's Pat Rawlings depicts large volume structures built on the Moon, requiring a lot of excavation plus the hauling of a lot of shielding material up onto the clear span shell. [The same drawings and art were used by the ill-fated **Lady Base One Corp.**] It was a bold yet quixotic concept.

### **Advantages of Rilles for Construction**

In contrast, rille sites offer pre-excavated sites and the opportunity to pull shielding soil down upon any structure built in the lower portion of the rille. By virtue of its flanks, a rille site offers a vastly greater heat sink [the temperature of the soil below the first couple of meters is steady  $-4^{\circ}\text{F} = -20^{\circ}\text{C}$  all month long - all year long]. By the same token, from vantage points along the bottom, appreciable fractions of the sky that would otherwise be above the horizon are eclipsed by the rille sides. Consequently there is even less exposure to general cosmic radiation [Lunar sites, having their butts covered by the soil below, have only half the exposure that space colonies will have].

### **Observation**

Sinuous rilles often do not occur as isolated features. They are, after all, collapsed lava tubes. It is common to find a complex of rilles, partially collapsed lava tubes, and (by inference) uncollapsed suspected integral lava tubes, all radiating outwards down the gentlest of slopes from the principal sites of the great magma lava upwellings that filled the vast lunar impact basins forming the "seas" so familiar to us. A well chosen site should offer considerable regional expansion opportunities.

We have high resolution orbital photos of several such features. David Scott and James Irwin of the Apollo 15 landing mission explored a section of Hadley Rille from their lunar rover in late July, 1971. It was their photos that fueled my imagination. **MMM**

## Continuing our Report on PRINZTON

A 2-tier 3-village rille-bottom settlement for 3,000 - 5,000 persons

### Part II: RILLE ARCHITECTURE - GENERAL CONCEPTS

Peter Kokh, Mark Kaehny, Myles Mullikin, Louise Rachel

#### A. Atmospheric Pressure: a Supercritical choice.

Perhaps it is because most of today's exo-habitat designers have come to the space movement in the post-O'Neill era that so many of them seem to be what can only be called Earth-normal chauvinists. Without ever examining the potentially onerous consequences, they predictably specify, with a casualness more appropriate to choice of color, that their habitat design calls for Earth-normal atmospheric pressure and, where possible (as in space colonies), Earth-normal gravity. On the other hand, old-timers who have been space advocates long before O'Neill's watershed articles on Space Colonies, and who were reared instead by the likes of Arthur C. Clarke, Robert A. Heinlein, and others, are far more likely to put considerable faith in human adaptability.

The choice of atmospheric pressure is perhaps the single most critical design specification for an exo-habitat. There are two reasons for this. First, the propensity to spring pressure-caused leaks rises exponentially with the pressure. If you wish your habitat to be as maintenance free as possible, this should definitely be a nontrivial consideration.

Second, the inert gas nitrogen which accounts for an unnecessary 79% of Earth-normal atmosphere is in far shorter supply (as compared not only with oxygen which is abundant, but also with hydrogen and carbon) in most Solar System locales except Titan. If one is talking about close-ceilinged habitats with the minimal mass of atmosphere per usable square foot of floor space, nitrogen is already the pacing deficiency if one's native sources for volatiles are the soil moved in the construction process. [See "Gas Scavenger", MMM # 23 March '89]. Even though the needs for hydrogen (water, biomass, industry) are obvious and we are rightfully attentive to the problems of economical sourcing of this primordial substance, the potential import cost for nitrogen is even greater.

Now if this is already the case for close-ceilinged habitats, imagine what happens when you specify a generous headroom and vista-providing clearspan. Hydrogen and carbon needs will remain steady as they are more determined by square footage/acreage of habitable space. But when overhead space is more generously provided either for postcard views or better dilution of whatever undesirable emissions prove to be unavoidable, the cost of providing needed nonnative nitrogen soars.

We have frequently mentioned the Moon's need to develop non-terrestrial sources of the volatiles it lacks. Nitrogen will be at the top of the list, and the hydrogen needed is logically co-imported as ammonia (NH<sub>3</sub>) or methane (CH<sub>4</sub>) than by itself (H<sub>2</sub>). The single most effective thing we can do to cut the cost of imports lunar or space settlements will need to survive is to design out excess nitrogen.

It is for this reason that the MilSTAR design team chose to go against the flow and specify half-normal atmospheric pressure BUT with Earth-normal oxygen partial pressure. This results in an atmosphere which is 42% oxygen and 58% nitrogen with all the savings born by a 62% cut in the nitrogen import burden.

A common objection would be that we are increasing fire hazards with this much oxygen. But the amount of oxygen is no more than we are used to on Earth. It only appears to be excessive in contrast to the reduced nitrogen component. The O<sub>2</sub> partial pressure remains the same and it is that, not the O<sub>2</sub>/N<sub>2</sub> ratio that determines fire hazard. An objection seldom raised which we are far more concerned about is the possibility that the new ratio will result in a higher amount of potentially carcinogenic and tissue-degenerative free radicals. The answer awaits further research deserving of the highest priority given the make-or-break stakes.

Perhaps more than any other single design choice, the specification (implicit or explicit) of the amount of nitrogen needed will determine the economic feasibility of an exohabitat design. If we are at all sincere about human out-settlement of the space biosphere makeup and pressure specs for biospheres in free space or on the Moon. The present ho-hum lack of attention to this supercritical point does not say much for space advocacy. We recommend that Space Studies Institute, the research arm of the movement, push this study.



**Rille Habitat  
Basic Concept  
Cross Section**

**ILLUSTRATION  
David Cremer  
& Peter Kokh**

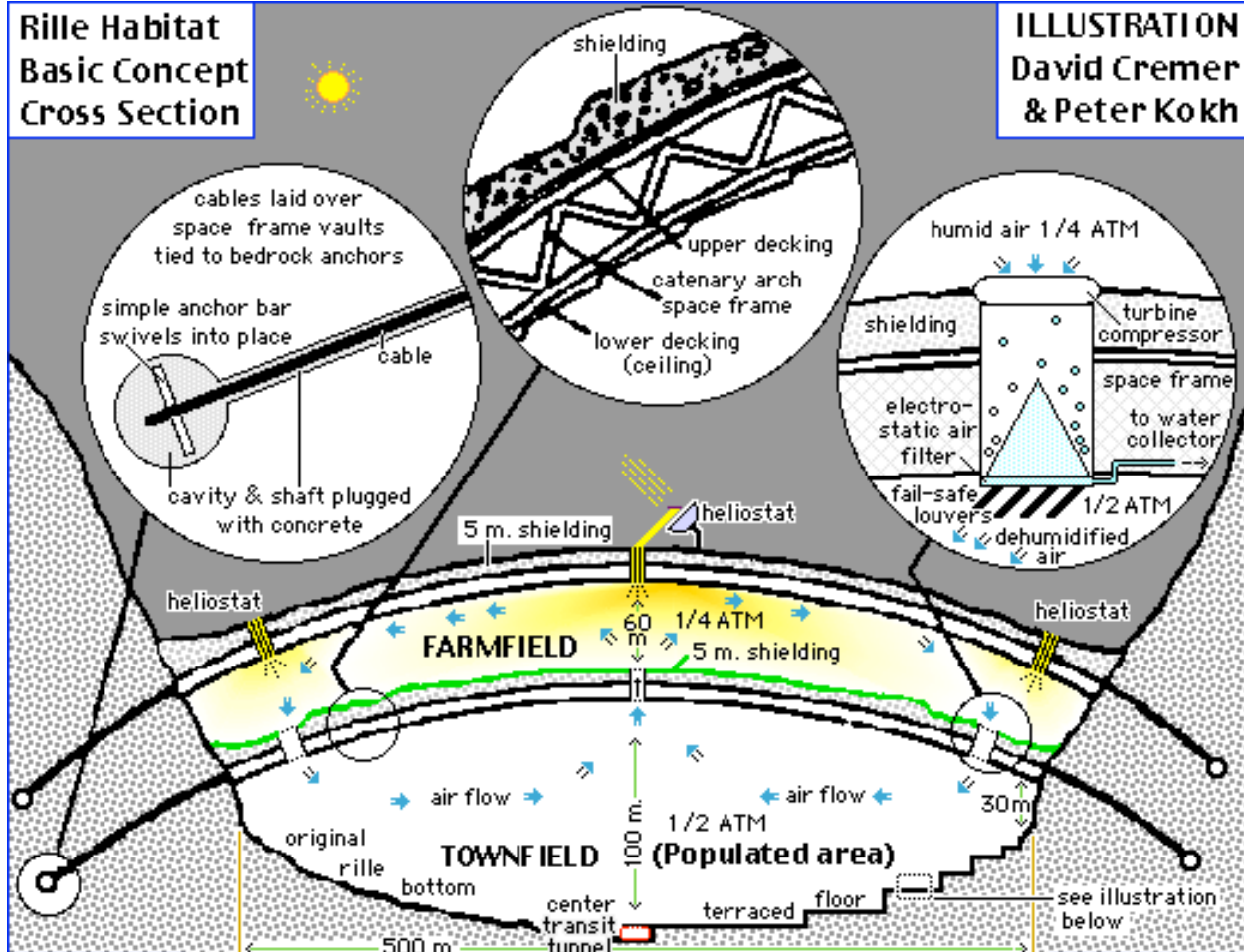

**B. Choice of a Two-Tiered Structure: "Townfield" below and "Farmfield" above**

In designing our rille-sited habitat for 1000-5000 persons (NSS competition specs), we tempered our desire for spaciousness and vistas, not only by specifying a significant cut in the nitrogen co-pressurant, but by vaulting over only the bottom of the rille, rather than capping it shoulder to shoulder. In addition, mindful that plants are less demanding than people, our design calls for a two-tier structure.

A **townfield** at the bottom of the rille enjoys the 0.5ATM (1.0 Earth-normal oxygen) just described. Suspended above it by the difference in air pressure is a **farmfield** (with less generous headroom) that has 0.25ATM with the same mix of gasses as below (hence 0.5 Earth-normal oxygen). This would be a largely automated agricultural area. The workers needed to tend this farm area intermittently, would be unmasked but supplied with a backpack oxygen tank and a mouth tube which they could activate by sucking on as needed.

The warmer, moister, but vegetation-freshened thin air of the farmfield would be exchanged with denser, cooler, staler townfield air by (downflow) fail-safe turbine condensers (which would also turn the humidity into potable water) at the rille sides and by (upflow) electricity-generating heavy-load fail-safe turbines along the high point of the vault-span.

Both vaults are space-frame type strut structures in the shape of the shallow portion of a catenary arc (the shape of a hanging chain) - the strongest shape in both compression and tension. [The St. Louis Gateway Arch is an example.] These vault frames would be decked both above and below, with cables overlying the topside tied to bedrock anchors in the side of the rille. 51 gm/cm<sup>2</sup> (0.72 lbs/in<sup>2</sup>)st [keep in mind the 1/6th gravity situation]. There would be somewhat more shielding near the rille sides so that at the point of attachment, net weight-above vs. pressure-below loads would be zero.

The vault-frames need not be built to carry uncompensated loads from either shielding or air pressure. Instead, once decked and sealed, the volume below would be pressurized gradually to keep pace

with the on-loading of shielding soil above. In the unlikely event of a failure to maintain the pressure differential that supports the lower vault, it would be suspended by normally slack cables to the upper vault. The increased air pressure on the upper vault in this situation, would more than support the weight of both.

The combined depth of shielding above the townfield area is some 10 meters (32') which far exceeds requirements for radiation and micrometeorite protection. Significant puncture of the upper vault would not be expected on statistical grounds in a thousand year timeframe – a much longer span than any Earth city design can offer.

The rille bottom would be terraced following computer-suggested lines to need a minimum of soil moving. The flattened and compacted terraces (perhaps reinforced with fiberglass mat), and vertical surfaces would be microwave-fused to a depth of half a meter and then sealed by laser-glazing. Thereupon the terraces would be paved with hollow blocks or slabs to provide both runs for utilities and an insulating air layer. The resulting surface would serve for walks and roads with all plantings in water-guarding pots, tubs, and large trays.

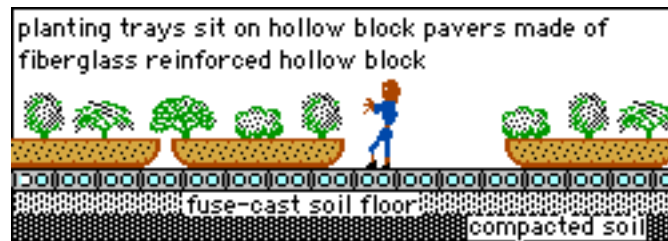

### C. End Caps for 2-Tiered Rille Structures.

Obviously, our structure has to have a beginning and an end. At first we considered some sort of vertical air dam since early on we decided to segment the settlement so that it could be built and occupied one 'village' at a time. We had hoped to come up with a barrier which would serve to end one segment and begin the next. However, there seems no way to build such a vertical barrier strong enough to withstand the pressure differential between 1/2 ATM and vacuum over such a large expanse (500 meters wide by 100 plus high).

The solution was to bring the soil-loaded (pressure-compensating) roof down the ends on a 45o slope. This sloping end-wall would have vertical baffles to hold soil shielding in place. Some 7 meters of shielding along the upper slope would supply the same loading in a vector perpendicular to the slope (inward to the farm area) as does the 5 meters on the upper vault. And 14 meters of soil on the lower slope portion would give the same loading vector against the greater atmospheric pressure in the lower tier as the combined 10 meters above both vaults. Thus we have a wall which is also a roof, and it works. This end slope wall would likewise have a shallow catenary convex shape and also be cable-tied to bedrock anchors. A solution with no weak spots is the result, although it meant that each village-segment would stand alone. The end of one could not serve as the start of the next.

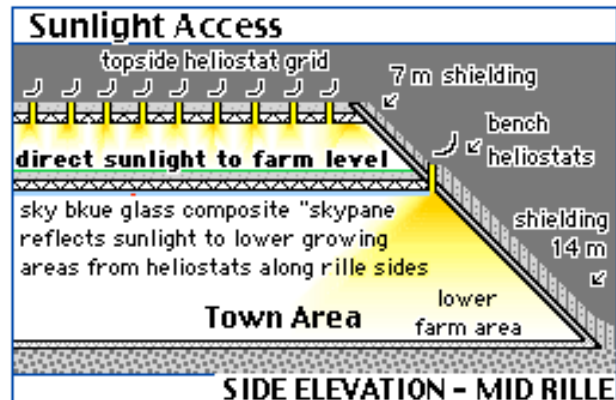
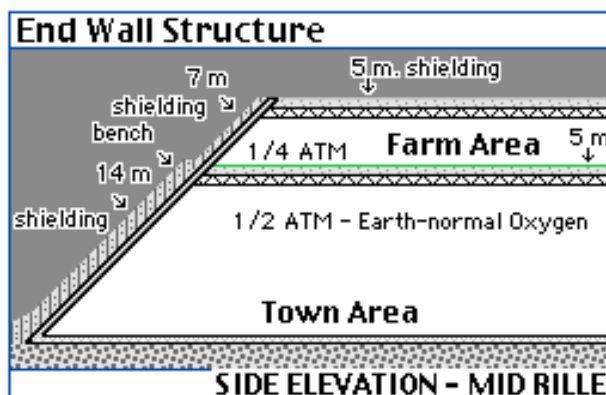

#### D. Bringing in the Sun.

We had already chosen an east-west section of rille so that the full fourteen days plus that the Sun is above the general horizon would be available to our villages. In a north-south rille, our bottom hugging settlement would be shaded by the rille side slopes for unwelcome stretches at the start and close of each local lunar 'day'.

Sun-tracking heliostats, concave mirror devices which concentrate the sunlight and channel it into the habitat below, would work well for the upper vault area, the primary agricultural acreage within the settlement. We came up with a low-tech design that does the job neatly enough. The low-tech approach is critical because many hundreds of such devices will be needed and our settlement must be able to manufacture them on the spot.

At the point where the sloping end wall meets the lower vault and the shielding increases from 7 to 14 meters, there is a 'bench' along the shallow curve of the end wall where an additional row of heliostats could be placed that have direct access to the end areas of the lower habitat area. This will mean these areas should also be dedicated to agriculture, especially to crops that need to be tended more often.

For the main central stretch of the lower 'townfield' area, we decided upon a different approach. Heliostats along the sides of the rille would channel sunlight down shafts to a point where it could be reflected off the vault ceiling. The lower vault would have ceiling panes of glass composite [Glax\*] that could be ribbed to catch and scatter this reflected light. They could also be formulated to have a sky-blue cast. A pleasant ambient light from a bright blue sky would thus pervade most of the lower residential area. Garden plots needing more intense lighting could use electric task grolights™ suspended over the beds, thus not wasting light where it isn't needed.

What about the night? This is a dual question. First during the local two week sunshine periods while farm areas above may want to use all of this, the residential areas below are free to shutter the light shafts to provide 'nighttime' on a 24 hr cycle. Second, during the local two week nightspan, the same sunshine delivery system can be used to direct light from efficient large electric lamps, via the heliostat optics and via the shafts that bounce light off the reflective skypanes.

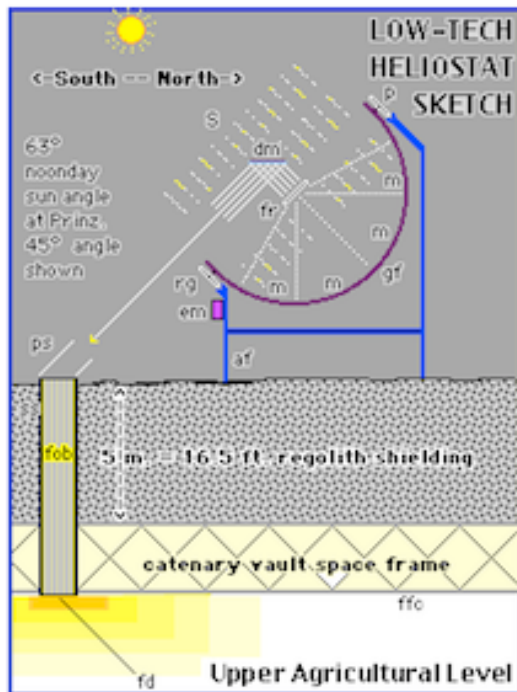

**A LOW TECH HELIOSTAT DESIGN:** a **dm** diagonal mirror which receives **S** sunlight from **fr** fresnel rectifier collected by flat **m** mirror segments mounted on a **gf** geodesic frame bowl rotating on a **p** pivot and a **rg** ring gear driven by an **em** electric motor on a stand with **af** adjustable feet. Sunlight is then channeled by a **fob** fiber optics bundle that allows a direct path while maintaining shielding. Bundle sits loose in **ss** shouldered sleeve with a **ps** protective shroud. Light passes through open **sf** space frame to **fd** fresnel diffuser set in the **ffc** farmfield ceiling, to spread a cone of light on field below. Heliostat turns all through the month (360°) so that it points at the ground at night to minimize mirror exposure. *NOTE: The sketch below shows the axis incorrectly.*

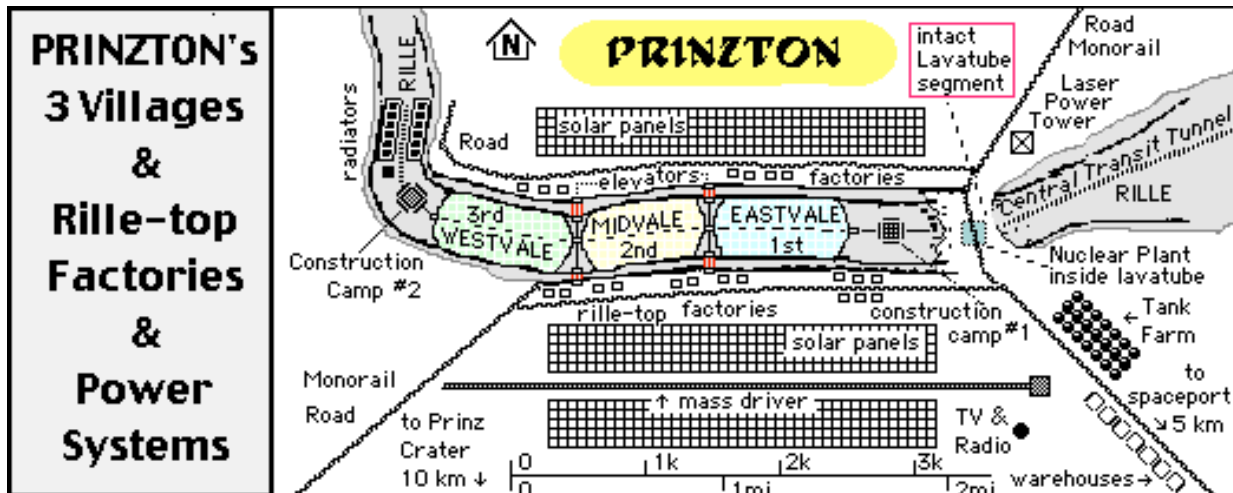

## SARDINECAN Fatalism

By Peter Kokh

July 20, 1989 Milwaukee, Wisconsin – The University of Wisconsin–Milwaukee (UWM) has received a 3-year \$105,000 grant from NASA's Universities Space Research Association, to build on its (UWM's) previous work in designing a Lunar outpost to include manufacturing, laboratory, and habitat space. The renowned UWM Center for Architecture and Urban Planning Research will direct the project in cooperation with the UWM College of Engineering and Applied Science, according to Center Director Gary T. Moore.

According to Moore, the UWM students face the challenge of making the habitats livable despite "the need to make them as small as possible." While Moore recognizes the need to provide get-away-from-one-another elbow room space for the ten or so persons stationed at the base, the NASA "sardine-can" approach is rooted in the agency's unwillingness to look beyond the deployment period in which everything must come from Earth in some payload bay or faring-space.

Moon Miners' Manifesto, also in Milwaukee, holds to the brash declaration of "Miners' Rights" implied in "Manifesto," and will continue to illustrate alternative options and to outline lines avenues of research that will create a frontier lifestyle that is both truly human and truly lunar.

One thing we hope the UWM group will consider, is an option of pairing private quarters on an alternating shift basis, with a two-sided works core sliding into the unoccupied walk-around space. A "works" core-modules would contain plumbing conveniences, climate control, communications and entertainment centers, etc., and possibly built-in fold-out, slide-out, pop-up, or pull-down furniture.

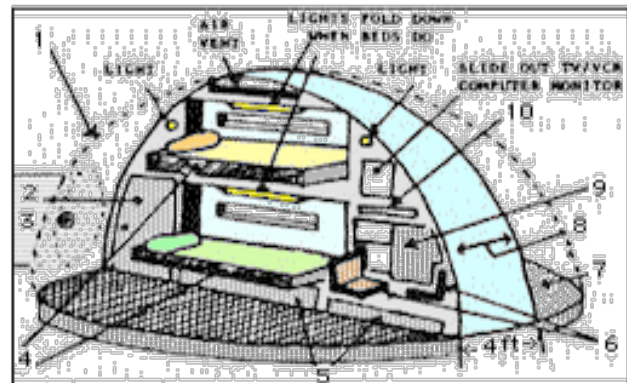
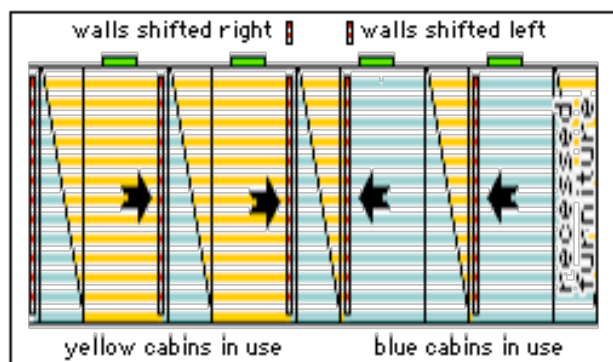



**KEY:** 1 Recycled fuel tank shell half or more spacious shelter made of Moon-processed materials; 2 Door to other cabin; 3 passage to other shells; 4 Fold down beds; 5 storage space 6 Slide out chairs; 7 Cabins also served by 8 Twin-sided works core; 9 Fold out table for meals, study, work; 10 Pull out lamp. © Dan Moynahan

Once we are can build habitat modules from local materials, these core modules could still be imported from Earth, without the original pressurized container and all the mass it comprises. **MMM**

## MMM #29 – OCTOBER 1989

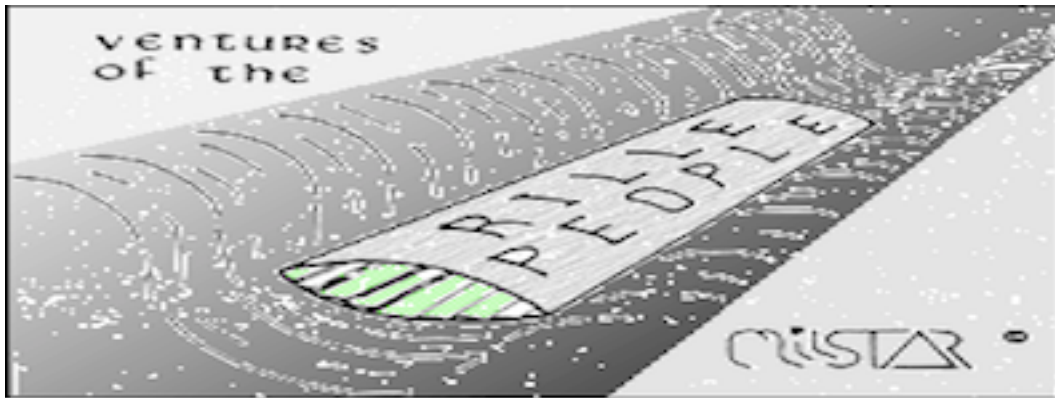

### Continuing our Report on PRINZTON

A 2-tier 3-village rille-bottom settlement for 3,000 – 5,000 persons

#### Part IV: The 3 VILLAGE RESIDENTIAL AREAS

Peter Kokh, Myles Mullikin, Louise Rachel

#### MODULAR HOUSING

Prinzton would be quite unlike any previous Lunar outpost or settlement. Gone will be the pressure-hull habitats separately covered with meters of shielding soil, the early form of burrow-warren life that will have become synonymous with Lunar subsistence, fulfilling the unanimous prediction. In such accommodations to the Lunar facts of life, there will be the starkest of differences between "indoors" and "outdoors", life and death.

In contrast, Prinzton is constructed within macro-sized and communally-shared pressure envelopes = the sealed rille floor and side-slopes capped with catenary vaults and end-walls. Such a scheme introduces an ample "middoors" environment, open space with generous picture postcard vistas and "shirtsleeve" freedom for getting about, for recreation, and for arranging homes and other buildings that do not need to be each pressure-tight. This will allow construction methods more reminiscent of back-home.

Yet there are important differences between building beneath Earth's starry skies and building under Prinzton's artificial sky-vaults.

- 1. Lunar gravity is 1/6th Earth-normal** or "sixthweight". This allows lighter construction for multistory structures, and freer use of cantilever techniques.
- 2. Building materials** commonplace to us may be unavailable: wood, vinyl and other synthetics, some metals. Concrete may well be expensive if economically recoverable Lunar polar ice deposits are not found by Lunar Prospector or other polar orbiters.
- 3. There'll be a premium on early occupancy.** This means that building shells must not be labor-intensive and must be erectable by fast and simple methods. Once occupied, they can be given fresh distinguishing exterior and interior treatments at leisure. Thus a certain look-alike cookie-cutter appearance is to be expected, with personalizing makeovers coming in due time.

**4. The very small labor market**, not only in contrast to our Earthside experience but in comparison with Space Colony expectation, will work to minimize initial options. "Modularity" will be at a very unsophisticated gross level, especially at the outset.

We had to take all of these things into consideration, in developing Town Plans for the three Prinztown villages. The first would have to be as simple as possible, yet with interesting and attractive features. The plans for the second and third of the villages should illustrate increased sophistication that the growing labor pool and increased industrial diversification will allow.

### Prinztown Village I – EASTVALE

The plan for the first village, was conceived by Peter Kokh. He chose a simple street plan with a closed loop boulevard, portions of which boast median canals, and 200 individual home sites, 2 100-unit apartment complexes, schools, offices, and other buildings all using a version of the same basic module.

The determining idea behind the EASTVALE Plan is that module shells would be cast in a Rille top factory (at high temperature with the need for concentrated solar heat) probably of glass-glass composites (Glax\*) of minimally refined formulation. With openings ready for fitting with standard window and door units, and with the interior surfaces ready for snap-in electrical service, each 1150 sq. ft. unit would be brought down the rille slope in a pressurized cargo elevator (whose dimensions determine module size) to the central freight-transit corridor along the rille bottom. Next they'd move into the village for essential outfitting at a central plant, and then to the homesite etc. for erection and immediate occupancy.

#### Everything in EASTVALE is Modular

From one basic module, 7.5x15x3.75 m., built in a rille top factory and brought down the cargo elevator, all homes, offices, schools, and apartment complexes are built. This ensures fast, simplified development.

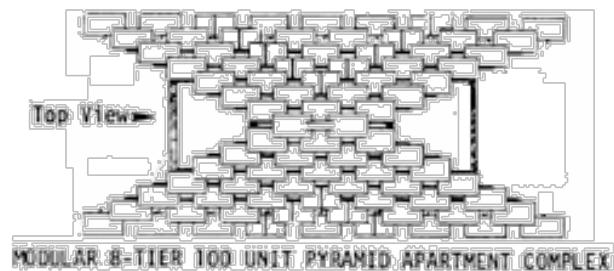
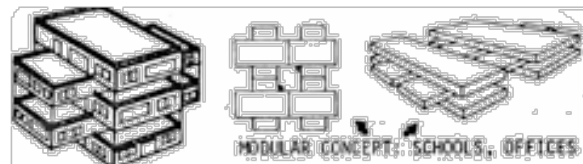
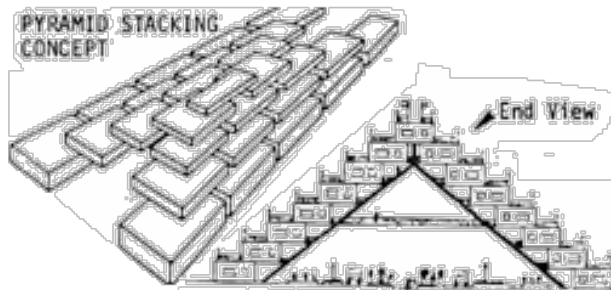

All other finishing would be done at leisure: surface treatments, interior walls, furnishings, etc. Large landscaping trays would be similarly designed to singly, or jigsaw-like, stack neatly in the same cargo elevator.

These restrictions offer a design challenge. Yet interesting combinations are possible via varied module-stacking methods. Above, are some illustrations.



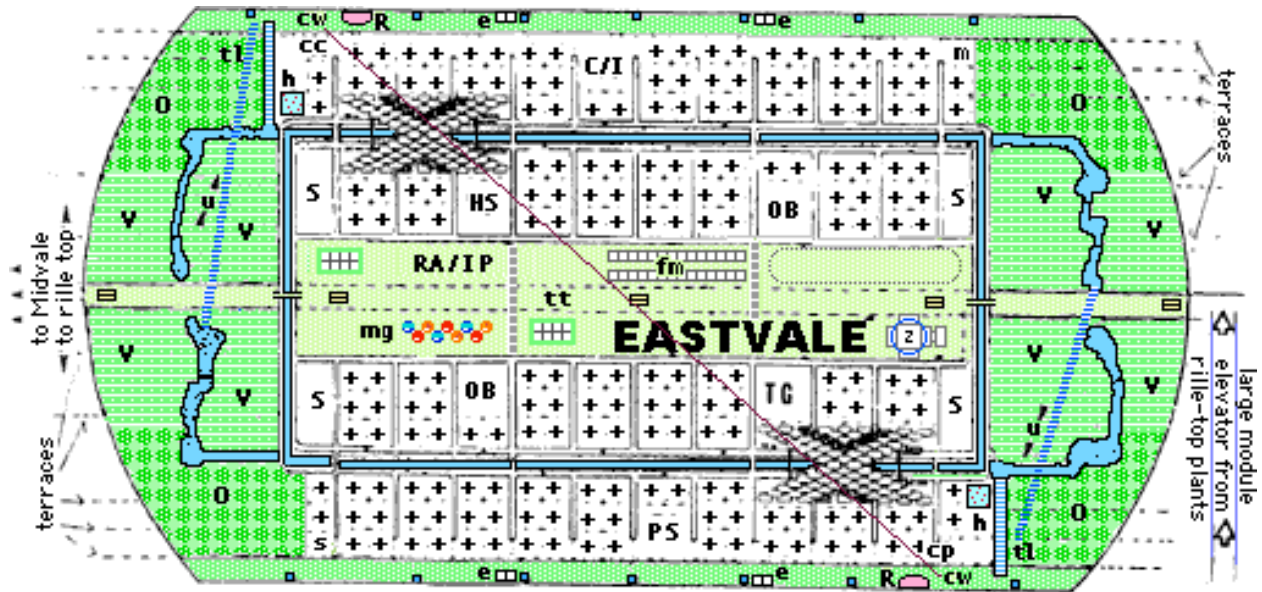

KEY: = Transit Tunnel Station

200 individual homesites 25m x 25 m Church, Mosque, Synagogue

KEY: C/I Clinic/Infirmary - V Vegetable beds - O Orchards - HS High School - OB Office Building - RA/IP Recreational Area above Industrial Park below - PS Primary School - S Shopping area - TG Eastvale Town Government - e elevators to Farm Level - cc Cath. church - cp Prot. church - s synagogue - m Mosque cw cableway (scenic) - h hatchery - R terrace view restaurant - tl trout ladder - tt transit tunnel people mover = tt station - mg memorial garden - Z Zoo - fm flea market - u underground water return - + 200 homesites 25x 25m

**Under the surface Recreation Area level**

cotton fabric spin + weave			1	2	3	building panel/module add doors+ windows etc.					
4	5	6	7	8	9	10	11	glass composite furniture shop			

- 1 basic apparel - 2 u-sew/ u-dye - 3 fiberglass fabrics
- 4 inorganic recycling - 5 carts/bikes - 6 wrought iron
- 7 glass - 8 stained glass - 9 ceramics - 10 repair shop

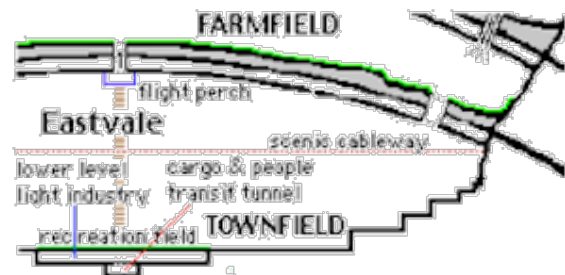

A dull and drab newborn village will slowly transform itself into a pleasant place to live. Homes could be several tiers high as families purchase and stack additional units crisscross on top of one another as the original "issue flat" is outgrown. Many such starter flats may be turned into home enterprise shops, as the growing family moves to new quarters above.

The original grays of crude glax surfaces will soon be hidden under glazes and whitewashes and other surface treatments: tiles, bricks, shutters and panels. Original balcony railing designs will add distinction. There will be an ever-fresh look to EASTVALE townscapes. The need to personalize and individualize will be a strong incentive for new settler enterprises (at first, spare-time endeavors, as everyone is needed to provide essentials).

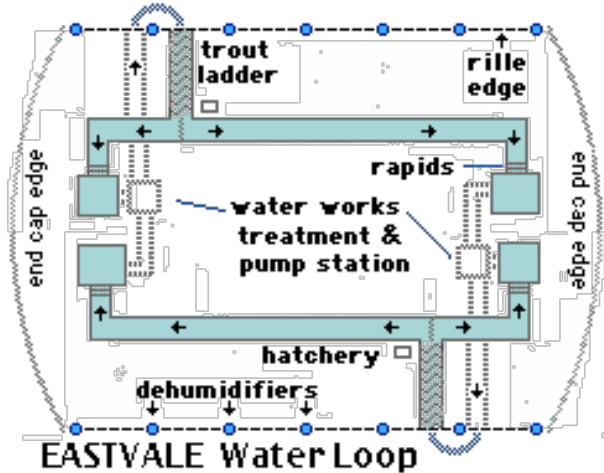
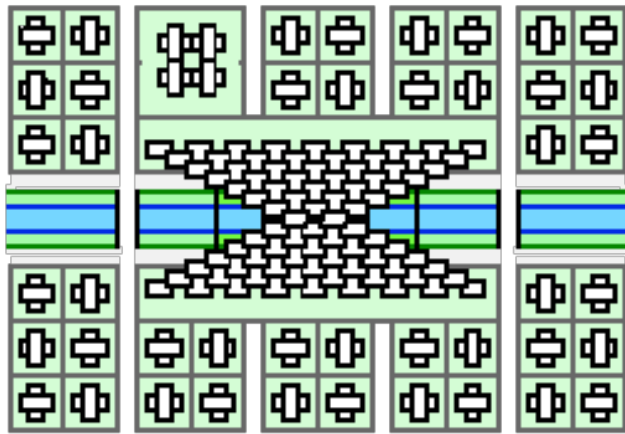

**Above Left:** Overhead closeup of one of four stacked Apartment Complexes that straddle the Canal Loop

**Above Right:** How surplus pre-treated waste water will add beauty and more to the town Industries involving heat, vibration and any potential biospheric contaminants are situated on top rille shoulders.

EASTVALE boasts other amenities. A scenic cableway crosses the townfield valley from the NW upper corner to the SE upper corner [see Eastvale Village Plan on page above.] It also boasts a small (just seven standard modules) animal zoo and aviary in one corner of the central green space recreational area.

It is vital that Lunan children grow up with first hand awareness of the animal life that shares our home planet with us. This modest facility would be enough to house a token selection of easy to care for feathered, furry, scaly critters. And some that could be brought out to pet!

There is also a stairway hugging the sloping underside of one of the end caps leading to a perch from which young and old can try their arm-mounted wings at human flight, an age-old dream never realized on Earth because of its high gravity. See the partial cross-section elevation at the top of this page. Here is how the stair way and perch looks from the side. It would be quite a walk up in Earth gravity, but not on the Moon . Many a pioneer will make the climb just for the view, and yes, perhaps to work up the nerve to fly!

## Prinzton Village 2 – MIDVALE

Design by Myles M. Mullikin

Mullikin realized that by the time construction of village #2 began, pioneers would be ready for both more diversity and more luxury in housing. This would mean diversifying industry and food production as well. He also realized that #2 would be ideally situated to include the 24 hour functions of service and recreation. Eastvale would be hours ahead, Westvale 8 hours behind Midvale, with all the factories running around the clock. So Midvale is divided into two districts: the Metro in one half, the village in the other half.

# MIDVALE

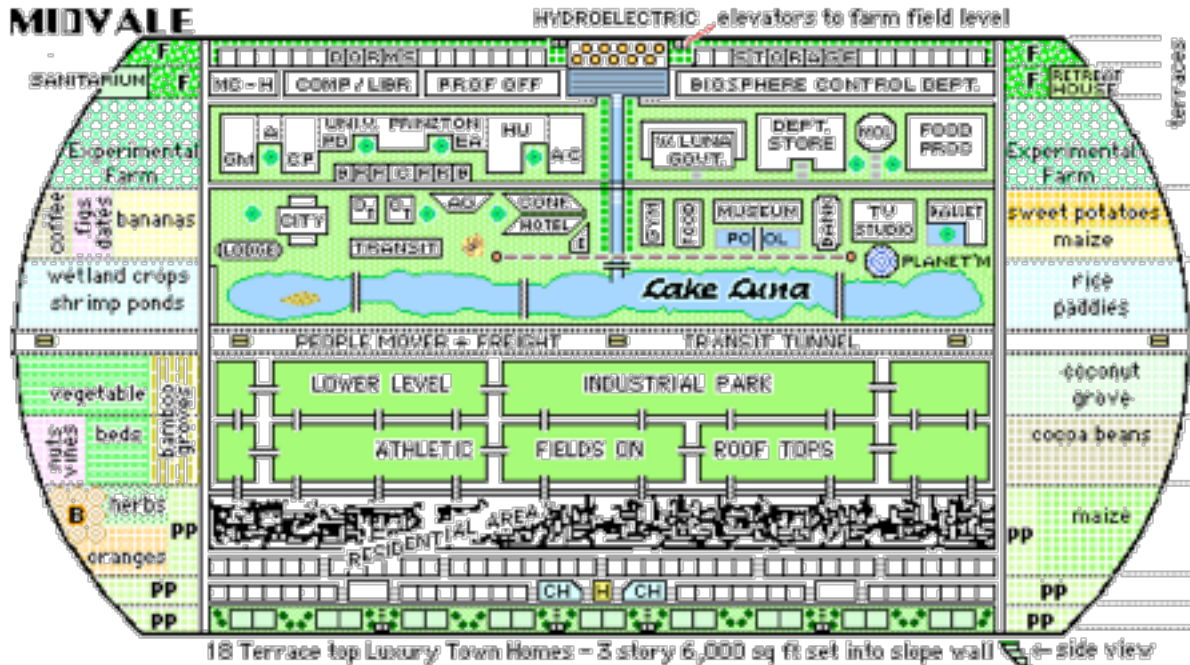

The residential district includes homes for Prinztown's more affluent individuals and their families. Three story slope-hugging mansions are included. See the illustration in the Midvale Town Plan above.

MIDVALE's Village District features neat subdivisions of cluster homes, apartment blocks for young couples, luxury town-homes, even a few high terrace mansions. This quantum leap in sophisticated modularity. As Prinztown grows, there will be ever more people to do ever more things. More individuals will be able to make serving the discretionary consumer market their principal occupation.

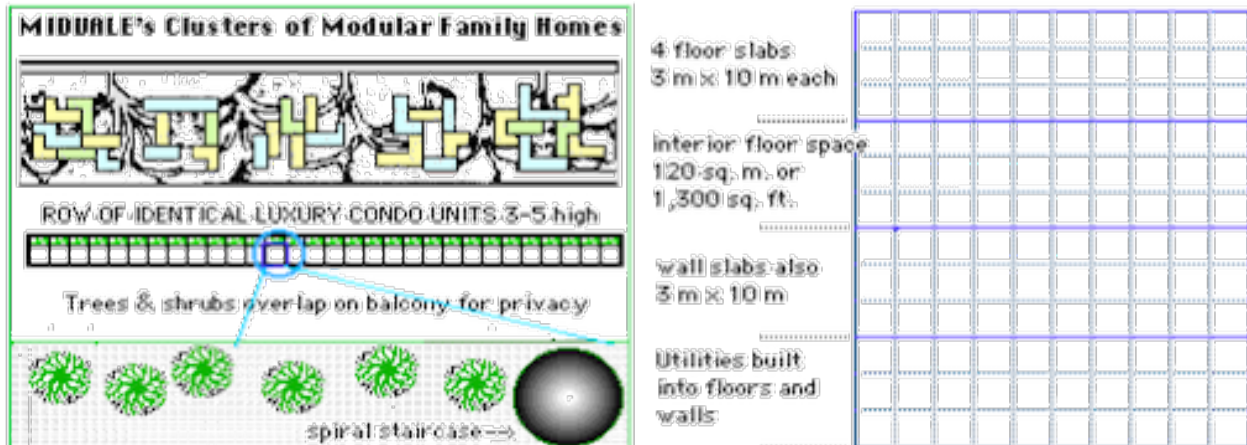

The all-in-one habitat unit has been abandoned as the basis for construction. It has been replaced with modular floor slabs, wall panels and other elements that can be fitted together in a greater variety of home designs with substantially greater architectural freedom from the outset. But again, high temperature casting is done on the rille top, but now assembly is finished within the village industrial park. Early occupancy is still the driver, but in a less urgent manner.

## The University of Prinztown

Small but vital, the University of Prinztown in MIDVALE will have enterprise formation and assistance as major functions. Concentrating on research and development of 'Moon-

appropriate' materials, methods and processes, and marketable applications, the university will further the growth of both the export and the domestic economies. The health of the people will also be in its care. These missions will make the UOP the lead agency in advancing Settlers' ever more thorough acculturation to their adopted world.

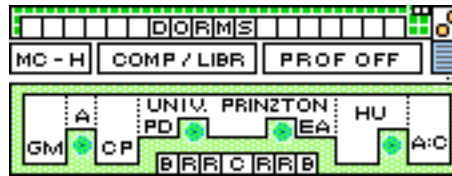

**KEY:** The dorms serve students from elsewhere on the Moon. MC-H – Medical Center & Hospital. Computer Center/Library. Professional Offices. U. of Prinnton Schools of Geology & Mining, Astronomy, Chemical Processing, Product Development & Enterprise Assistance, Humanities, Arts/Crafts. B=Bar R=Restaurant C=Cinema

### A “Downtown” Metro District for Prinnton

MIDVALE's business district serves as Prinnton's downtown. More than likely, Prinnton will serve as the metropolitan center for a number of outlying smaller mining settlements in this whole general area of the Moon. This will all work to make the Midvale "Metro" District a much livelier place than one would suspect from its size.

A “Lake” and a series of water cascades and waterfalls flowing out of a hydroelectric power plant? On Luna? “Lake Luna” itself is but a shallow lagoon, but below it is a major reservoir for the hydroelectric system. Overflow from the Lake goes into this reservoir. During the two weeks of dayspan, excess solar power is used to pump pump water reserves up to holding tanks up on the rille shoulder. During the two week nightspan, this water is allowed to flow down the rille slope to generators on the top terrace of the Midvale town Field.

So the hydroelectric system involves both a closed loop and a very large head. The reserves held on the rille top have as much potential energy as the water feeding niagara Falls, even in the low gravity.

How the Hydroelectric Loop works will be the subject of a follow-on article in this series, “Putting water reserves to work” is a primary design goal. Myles paid great attention to his water circulation plan. **MM**

## Prinnton Village 3 – WESTVALE

Design by Louise Rachel (now Quigley)

Similar construction systems would be employed in building Westvale. The designer specifies a single neighborhood to one side of a spacious village Commons. This residential neighborhood integrates several housing types around terraced and lushly landscaped courtyards.



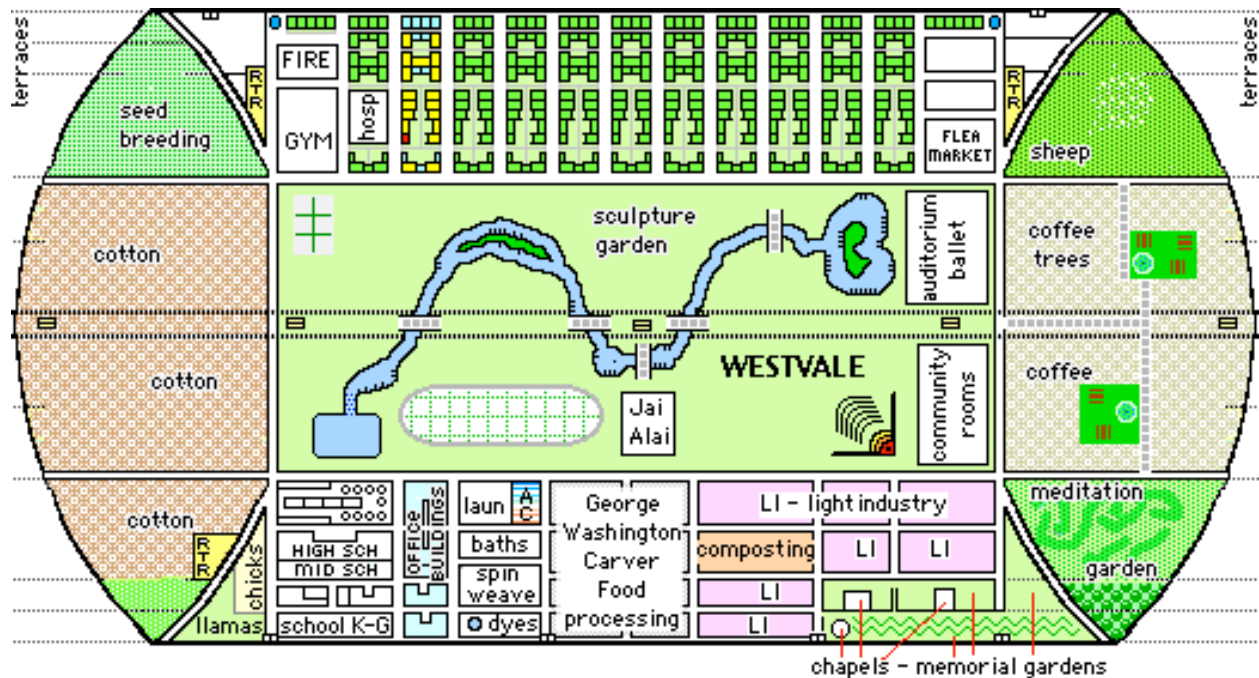

In WESTVALE, there will be ample provision of communal space for enterprise nourishment. By the time such space becomes available, some of the infant enterprises nourished in Eastvale might be ready to graduate to the more spacious quarters and to quantity production techniques. 'Make-overs' by the mushrooming cottage-indus-try-based enterprises will greet return visitors to Prinztown with much that is new and interesting. L R Q

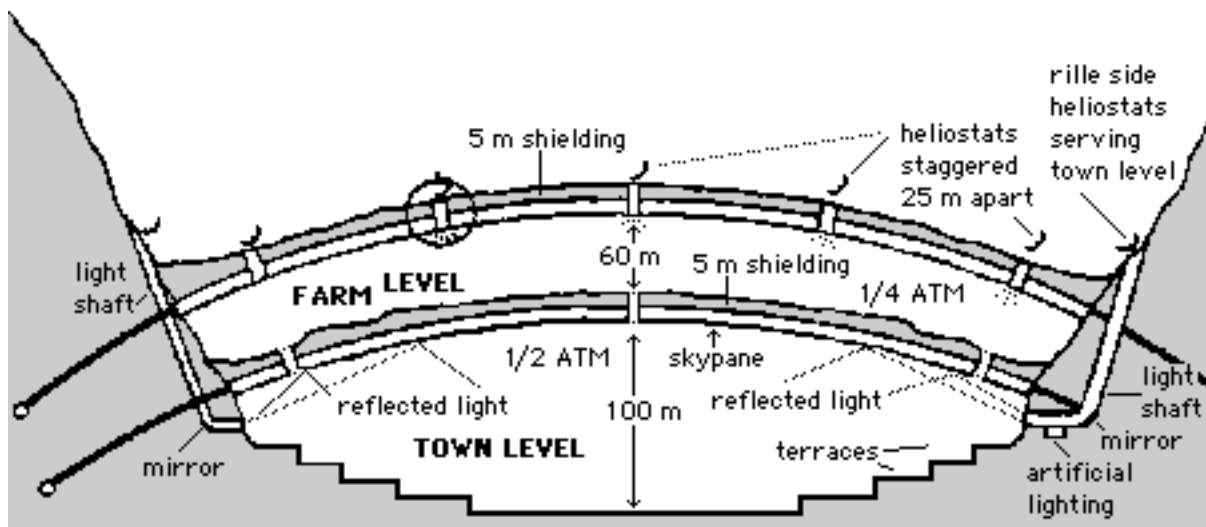

Above: A cross section of the 2-level Rile Bottom Settlement and its basic architecture

MMM #33 - MARCH 1990

**GLASS/GLASS COMPOSITES**

Ongoing SSI-Supported Research

Brandt Goldsworthy, the President of Alcoa Goldsworthy, reports that testing of the feasibility of producing glass composites from loose lunar regolith soils by solar heating will begin sometime this year (1990). McDonnell Douglas has a spare parabolic solar concentrator able to produce temperatures above 3000 °F (1650 °C) needed to melt the raw material, and has agreed to lend the unit to Goldsworthy.

Crude glass-glass composites on the analogy of fiberglass reinforced plastics (RFP) would be the easiest way to build structures needed for a lunar settlement using on site materials. Some further refinements could provide export-quality building materials for income-yielding export to space construction sites.

Below: a **Popular Mechanics** illustration of such a highly automated early lunar industrial installation.



MMM #37 – JULY 1990

## RAMADAS

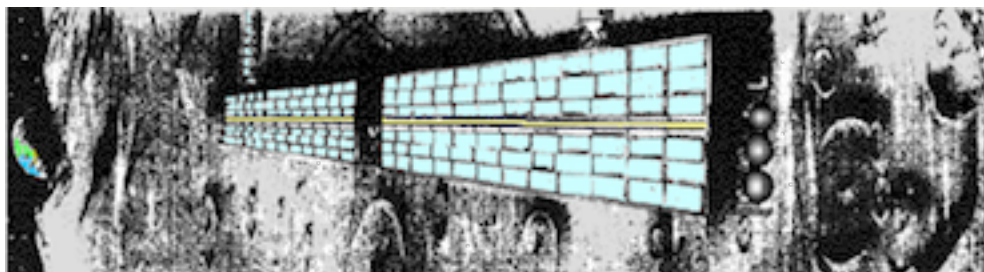

### RAMADAS: “YARD” AND WORKSITE CANOPIES FOR LUNAR OUTPOSTS

Artwork by Dan Moynihan – Article By Peter Kokh

Examine a picture of an Antarctic Base, and you will see a cluster of main buildings awash in an unplanned, unkempt cluttering of fuel tanks, stockpiles of supplies, new equipment not yet installed and old equipment already retired, trash dumps and so on. Base architects have a tradition of leaving to afterthought the siting of necessary external paraphernalia, the things that make base operations work. Nor is such an unsightly hodgepodge of land use expediencies the only result. Since the realities of base operations were not taken into account, as only individual structures rather than integral functioning of the base as a whole – or likely patterns of growth and evolution – received attention, it is an inevitable result that such sloppy installations function rather less efficiently and less safely than they might.



The sketches available of various Moon Base designs, be they the product of NASA think tanks or of outside sources, share this ivory tower penchant for neglecting patterns of likely land use in the immediate vicinity, in the front and back "yards" of principal base structures.

It is inevitable in any Lunar Base operations scenario, that an appreciable portion of routine "out-vac" EVA activity will take place in a few concentrated areas, especially the immediate vicinity of the Base itself, and of its component structures and facilities. There should be a very thorough effort to identify and categorize the types of activities involved and the intensity of use of these "yard" spaces.

Current planning and design provisions make no distinction between those EVA activities on the base doorstep and those spacesuits-required activities at some distance from camp. However, the relatively high intensity of usage of selected close-in areas for storage, staging, repairs, or other repetitive outdoors housekeeping tasks, offers us an opportunity to make such routine activities both safer and easier.

By designing lightweight, modular, and easily deployable work canopies or "ramadas" strong enough to hold a few centimeters of regolith insulation blown on top, Lunar Base architects can provide built-in cosmic ray, ultraviolet, and micrometeorite protection for these high use activity areas. ["Ramada" is a Spanish word common throughout our treeless plains and desert areas for the shade-providing shelters at roadside rest stops.] Providing ramadas will allow those working in such sheltered areas, while still exposed to vacuum, to wear lightweight more comfortable pressure suits. Under such improved conditions, those working outdoors could put in more hours with significantly less fatigue, with lessened vulnerability to random micrometeorites, and with reduced cumulative radiation exposure.

Such ramadas might be attached to various base structures themselves, in an analogy to awnings and lean-to sheds, or stand free but adjacent to them. They could cover an area continuously or make use of overlapping panels to allow some reflected sunlight to ricochet between top and bottom surfaces into the working spaces below.

Those whose assignments take them beyond such protected yard areas will still require the heavier more cumbersome hard suits. For some such cases it may be possible to design mobile or "redeployable" ramadas to use at temporary sites of heavy outdoor activity such as can be expected in the field at prospecting sites or with the time-consuming installation of scientific equipment, solar arrays etc.

Kevlar fabric slung over frames of aluminum poles, all brought from Earth, could form the earliest ramadas. In the light "sixthweight" of the Moon, such fabric would be more than strong enough to support an overburden-load of several inches of loose regolith shielding. As Lunar manufacturing develops, glass-glass composite panels covering glass-glass composite lightweight space-frames and pylons, all manufactured on site, could fairly early on become the standard means of providing safe workspaces sheltered from the avoidable "elements" that buffet the exposed Lunar surface.

We began this article by pointing to a general unsightliness that has come to be characteristic of this country's Antarctic bases. While a strategy of careful management of high-use yard space, including the use of ramadas, would clean up much of this clutter, on the Moon as well as in Antarctica, that is certainly not its principal merit. The unsightliness, as much as it grates, is but a symptom of the deeper ill of lackadaisical management of base operations. It betrays an attitude which is of one piece with that same carelessness which breeds accidents, both mechanical and human.

Most will accept that we cannot tolerate the expense of mismanagement on the Moon. Part of good base management will consist in providing the safest possible routine working conditions. The added cost of bringing along the materials to erect ramadas over those highest-use outdoor areas around the base will be well justified. Next time you see an artist's depiction of a Moon Base, whether it comes from NASA, the Lunar & Planetary Institute, SSI or Eagle Engineering, ask yourself "what's wrong with this picture?" If the grounds look neat and

uncluttered all without ramadas, the rendering will clearly be more akin to science fantasy than science fact.

If ramadas are essential facilities for Lunar bases, no matter how absent from base concepts currently in vogue, then a national competition to come up with some good design options will be in order. Such a competition should have three categories:

- (1) For first generation bases, the most economical use of imported material; per square meter sheltered;
- (2) For next generation bases, early practical use of building-materials made on site; and
- (3) Mobile and/or redeployable ramadas for use in the field. Prize money to entice participation could come from traditional sources such as aerospace contractors, but also from materials industries who wanted to promote the use of their products e.g. Aluminum, Kevlar, Glass, and Steel, or from construction firms. **MMM**

[This article is an expansion of an abstract sent to AIAA in response to its solicitation of ideas for Moon/Mars Missions & Bases. Thanks to Michael J. Mackowski of St. Louis Space Frontier Society for alerting MMM to this opportunity.]



## FLARE SHEDS: BUTT-SAVERS IN THE OUT-VAC

By Peter Kokh

[For a related article, see "WEATHER," MMM # 6 JUN 87, republished in MMM Classic #1]

The Sun does not rotate integrally as would a solid-surfaced body. We can clock its rotation by watching sunspots, slightly cooler areas that look black only in comparison, slowly transit from west to east over a two week period. Spots nearer the equator are carried across the face more quickly than those near the poles, marking one rotation in about 25 days, compared to 28-some nearer the poles, and as slow as 36 days at the poles themselves.

Keep in mind that sunspots, occurring in pairs, mark places where intense magnetic fields project from the surface, and it becomes clear that the Sun's overall magnetic field must become ever more tortuously twisted and kinked with each differential rotation until the pattern finally can be maintained no more. Such a crescendo is eleven years a-building. At the end of the cycle, the magnetic polarity reverses, so that the overall pattern repeats every 22 years.

Solar flares might be seen as the bursting of solar-energy "dams" maintained by great magnetic forces within these sun spots. As the dam bursts, a flood-surge of energetic particles heads out from the Sun at an appreciable fraction of the speed of light. Light takes 8 1/3 minutes to span the distance between the Sun and Earth (= 93 million miles = 150 million km = 1 Astronomical Unit) so when a flare is spotted (if anyone, anything, is watching!) we have only a few moments before the deadly storm hits. For the associated X-rays advancing at light-speed, the only warning possible is a means of predicting such eruptions.

On Earth we are sheltered from the full fury of such lethal solar flares first by the Van Allen radiation belts maintained by the Earth's own magnetic field, and then by our atmospheric blanket. Nonetheless, enough energy some times gets through to disrupt radio communications for hours, even cause massive power outages by inducing current surges in transformers and transmission lines. Though the inconvenience for us is mild in our protected cocoon, and while

they cause spectacularly beautiful auroras, we can be grateful that flare seasons come 11 years apart.

The most intense portion of a flare onslaught can be over in just minutes or last a few hours. Beyond the Van Allen Belts, the need for shelter is immediately pressing. Flares can occur in clusters and single flares can have the energy of hundreds of millions of hydrogen bombs. The direction the torrent takes is random, depending on the location of the source spot on the solar surface.

Unless we are to limit our activities on the Moon and throughout space in general, to quiet-Sun years, two things must receive priority attention:

1. Developing a Flare Early Warning system
2. Developing a network of storm shelters within reach.

The first need is touched on briefly in the earlier MMM article cited above. The second requires multiple strategies. On route to Mars, we can put all the fuel and cargo and equipment sunward of the passenger cabin (the "P.O.S.H." strategy: Passengers Outfacing, Sun-facing Hold). Coming home with empty holds and tanks presents a more stubborn problem. But here we want to highlight situations on the lunar surface.

Lunar bases, habitats, factories, and whole settlements will be sufficiently protected by the same 3-4 meter thick overburden of loose or bagged regolith shielding that shelters them from cosmic rays and micro-meteorites. Surface activities in the immediate neighborhood of such sites should present no problem even in high flare season. But in time an outpost or settlement will be joined by others as the lunar beachhead transforms into a more "world-like" SET of human places. How do we protect those traveling between such protected sites?

Surface vehicles can be designed top heavy with batteries, fuel cells, cargo and other heavy equipment on top – that's sound practice anyway, and the center of gravity problem can be handled by longer wheelbases and wider tracks – no problem when the cost of real-estate and right-of-ways is moot. While these measures will reduce routine exposure to other hazards, they may be less than adequate during solar flares, especially when the Sun is at a low angle over the horizon. Ports in the storm will be welcome.

Open ended north-south facing quonset-type shells covered with a couple meters of soil, situated at intervals along established routes, could harbor a number of vehicle emergencies. How close will we need to put them? Obviously that depends on things we can't pin down as yet. First, how much early warning time can we expect (= how much time do we have to take cover) and how much ground can vehicles traverse while the clock is ticking. We'll want a reassuring margin of safety.

The need to reach shelter with time to spare and the relative expense of erecting such flare sheds could put a real premium on vehicle swiftness, well-graded roadways, or both. Excursions off-the-beaten track in "shedless areas" may be limited to emergencies, during flare season. The alternative is to travel during the 2-week-long lunar nightspan in the "lee" of any storms. This may work to confine lunar "rural" outposts along established routes between major settlements or to provide storm-cellar-equipped vehicles to service the less frequented routes.

Over time, if traffic increases warrant it, some of these flare sheds could grow into more full-featured facilities: emergency communications, automatic self-replenishing liquid oxygen depots, drop-off points for fuel cell water to be automatically electrolyzed by solar power back into liquid oxygen, and hydrogen, for fuel cells of other vehicles, hoist-equipped repair ports, unstaffed hostel-type bedroom space and so on. Eventually, some such oases might even become the first humble beginnings of whole new towns.

The way lunar development proceeds, from the placement of outposts, the design of vehicles, and the preparation of roadways – much that will shape the unique character and feel of the Lunar Frontier – will trace back to this need to cope with the occasional deadly solar flare. Storms do have their usefulness! **MMM**

# Polders, A Space Colony Model

POLDERS: A Space Colony Model By Marcia W. Buxton\*

\* Cultural Anthropologist & founder of Northwest L5 Society Chapter (now Seattle L5/1) in June 1996

From the beginning of human civilization families have made sacrifices for their children and for future generations. In order for human civilization to continue it seems self evident that families must eventually move into space and become a spacefaring people. An interesting parallel can be drawn between the familial movement into space colonies and the Renaissance development of the Polder System in the low countries of Europe. Each is truly an artificially created environment.

"A polder is a piece of land won from the sea of inland water and is constantly defended from it thereafter," explains Paul Wagret in Polderlands. Beginning in the 11th Century along the Northern Coast of Europe families labored to painstakingly force the sea to relinquish land in order to provide farm land for their progeny. These brave men and women worked hard to provide future land not for themselves but for their children and their children's children. In the same way serious thought must be given by all families today to look to space colonies to provide a better life for their future generations.

The family structure as it had developed by the 11th Century, in what is now the Netherlands, decreed that at a husband's death his widow received half his wealth excluding his land. All his farm land went to his eldest son and the remaining wealth was divided among the brothers. This custom allowed for a large enough area of farm land to be passed from one generation to another to sustain at least the eldest son. Daughters were generally expected to marry or enter convents to pray, teach, copy manuscripts and care for the sick. The remaining sons frequently were prepared to enter guilds to become expert weavers or other sorts of craftsmen. The center of cloth production was the city of Antwerp. Other sons might choose the monastic life.

In France, wealthy Lords would often grant monks the right to the marsh land on the edges of their properties provided that the monks endeavored to successfully drain the land for pastures and maintain them as polders. This "reclaimed" land was theirs henceforth. Here they constructed their religious buildings including stone towers which could be used as shelters in times of floods by the people living in the low lands.

Mont St. Michel is an example.

In the areas of Friesland, Zealand, and Flanders much of the land was a brackish peat bog bounded on the North by the Sea (illustration below). As the population expanded, the digging of peat to be dried and used as fuel became necessary. The word "polder" may derive from the Flemish word poelen, meaning "to dig out". This digging was done in conjunction with the digging of ditches for the drainage of the brackish water into the sea. This lowered the water table and the people learned that when these [newly] created dry areas were planted in clover and desalinated with natural rainwater, eventually this area became land where cattle could graze and much later hops, hemp, flax, colseed, rapeseed, cereals, and finally flowers could be grown successfully. This often became the land of second and later sons.

In order to aid the drainage of the low lands, canals needed to be constructed. Dikes using woven willow twigs and burnt clay bricks were built systematically to keep the brackish water from returning to the hard earned low crop lands. The area is often six feet below sea level. Great care needed to be taken not to dig for peat too near the dikes which might be weakened causing catastrophe.

By the 13th Century primitive windmills and lifting dredger buckets were established along these "highways" of brackish water. Younger sons became inheritors of the early windmills. Bridges, locks, and paths were built along the canals to aid the families in fetching drinking water which often could only be obtained by going a considerable distance to an area where rainwater collected sufficiently for fresh water wells.

At the end of the 15th Century due to religious persecution in other countries many immigrants, particularly Anabaptists and Mennonites who refused to bear arms, fled to the low countries. Here the ruling class, perhaps because some of their ancestors had been among the Crusaders in the Holy Lands and had opened up early trade routes and welcomed new ideas and foreigners, respected these people who were willing to work so very hard to drain fields and maintain the polders. And they, as other polder workers, were exempted from military service and payment of land taxes. These immigrants were allowed to organize their own schools and churches.

The development of the canal and polder system was not without many real catastrophes. There was often great destruction but always followed by rebuilding. The canals also began to serve other purposes and small barges were used to develop an efficient system of primitive commerce, dispersing beer, wine and salt. With the beginning of commerce came certain restrictions. Members of the ruling class, usually people owning large amounts of land but who lived in the towns and villages, began to demand tribute for the use of the canals near the villages.

The continuing need to dig for peat for fuel which enhanced the reclamation of the low lands, the emergence of the windmills, the building of locks, and the slowly developing system of commerce encouraged the establishment of "high water authorities" and water boards. Voting rights depended upon ownership of farm land. Among the peoples of Utrecht, Netherland, Zeeland, and Flanders there were to become in the 14th Century the *hoogheemraadschappen* or high water authorities and [they were] responsible only to the governments. At the local level these *Waterschappen* came to serve the function as a court of law.

Just as the marsh lands were reclaimed from the sea with embankments, with increases in population attention needed to be paid to reinforcing the coastal sand dunes along the North Sea. Wagret describes a polder dike as being perhaps 40 meters in width, but a main sea dike may reach 80 to 100 meters in width. The ebb and flow of the tidal currents along the sea coast sometimes caused erosion.

Jan de Vries, in *The Dutch Rural Economy in the Golden Age*, remarks that rural districts were prohibited from brewing, spinning, weaving, or ship building but that skippers of barges passing villages were required to dock, unload their cargo and allow their goods to be offered. In 1575 there were elaborate plans made which are reminiscent of the early plans and dreams in the 1970's of the L5 Society for Gerard O'Neill's High Frontier. His "Bernal Spheres" concept, housing 10,000 people, were to be nearly a mile in circumference and rotate to provide gravity comparable to that of Earth. The L5 Society proposed building such habitats by the end of the twentieth century from lunar materials to provide living space for workers and their families in a space manufacturing complex producing, among other things, satellite solar power stations to supply cheap, clean power to Earth.

Immigrants to Bernal Spheres were to develop a better life for themselves and for future generations. It may not have been by digging peat out of low lying bogs and creating drainage ditches, but by using materials from the Moon, colonies would be created and solar energy would be utilized to grow food in a closed system, and eventually there would be trees, streams, attractive housing, and a peaceful environment for future generations. One space colony would act as a stepping stone to the building of others.

The *Haarlemmer Meer* Book of 1575, by Jan Adriaanszoon, describes an elaborate plan to build 160 windmills and to build extensive canals to drain a major lake area. Like the L5 Society's early dream it was not developed immediately but finally with the invention of the steam engine the project became a reality in 1852.

By 1607 the Leeghwater's Beemster drainage project using 43 windmills created 17,500 acres of usable acreage. Some of the money necessary to finance this project came from the highly successful Amsterdam merchants of the East India Company, trading primarily spices, sugar, coffee and tea. Land owners were encouraged to grow livestock to provide large amounts of butter, cheese, and livestock that could be exported abroad.

Near Amsterdam by 1649, six villages combined efforts to provide a dairy for the nearby city, using their farm lands for that purpose.

Capitalists beginning in 1612 developed ambitious large scale peat digging organizations. Plots were carefully laid out as were canals and locks where settlers dug the peat and later were able to claim the soil as homesteads [illustration below].

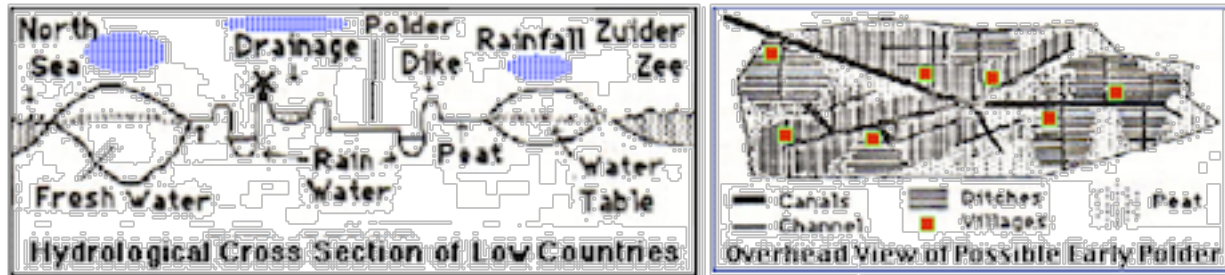

According to de Vries, "dike maintenance was an obligation divided among the villages that benefited from it." A land user was responsible for a specific segment and the Waterschappen supervised the system.

Windmill operators took on growing importance and were expected to keep the polders dry throughout the winter. In 1574 an 8 sided windmill was worth 3,500 guilder and the salary of a mill operator was 100 guilder plus a supply of candles in order to work at night! Rapeseed became a frequent polder crop and oil-pressing windmills in Northern areas often were kept busy the entire year. Windmills were also used for sawing wood [harvested] from carefully tended groves of trees.

de Vries writes that "the monastic lands yearly yielded several hundred thousand guilder for the support of education, health and welfare. Women played a very important role in the life of the religious community. Churches played a major part in the communities providing some education, but literacy in the majority remained low. Nevertheless five universities were established.

Canals became of increasing importance and interconnected the major villages and cities. Barging guilds were formed and established regular service between major cities. Frank E. Haggett sites that by the mid 1650's 80,000 acres had been reclaimed from the sea. The farmers taxed themselves hundreds of thousands of guilder yearly to improve the quality of their soil. Sea shells were ground up and used for fertilizer. Everywhere farm structures and homes were enlarged or rebuilt. Commerce along the canals flourished.

In 1667 there was a proposal to polder an inland sea, the Zuider Zee (See Figure 3). Hendrik Stevin developed the idea of closing off the incoming tide with sluice gates but allowing the ebbing tides to flow into the sea. Eventually the fresh water would replace the salt water sea. (The project was actually begun in 1927 and the first crops harvested in 1933 with 175,000 acres eventually reclaimed.)

By 1798 there were over 3,000 local Waterschappen and a central Waterstaat was created to fight against major floods. "The state set itself up as a protector against floods, the hereditary enemy of the country. The Waterstaat undertook works too large for small groups, collected data, coordinated hydrological observations and drew up maps. According to Wagret, 577,905 acres, or fourteen percent of what is now the Netherlands, had been reclaimed from the sea. The cost of the reclamation always exceeded the actual value of the land first brought into cultivation – only future generations were to be the true beneficiaries.

A worthy cliché, "God made the Earth, except Holland, which the Dutchmen made for themselves."

Might that we, with God's help, break free of Earth and build the Universe for ourselves!

MMM

#### References:

- **Barnouw, Adrian J.** The Pageant of Netherlands History. New York: Longmans, 1952.
- **De Vries, Jan.** The Dutch Rural Economy in the Golden Age 1500 – 1700. New Haven: Yale University Press, 1974.
- **Hugger, Frank E.** The Modern Netherlands, New York: Praeger, 1971.
- **O'Neill, Gerard K.** The High Frontier: Human Colonies in Space, New York: Doubleday, 1976.
- **Rachlis, Eugene.** The Low Countries New York: Time Life Books Spier, Peter. Of Dikes and Windmills. New York: Doubleday, 1969.
- **Vanveen, John.** Dredge. Drain. Reclaim. The Art of a Nation. 1962
- **Wagret, Paul,** Polderlands. London: Methuen & Co. 1959.
- **Note:** It is in the above sense that the word "Reclamation" is used in "Lunar Reclamation Society."

## MMM #40 – NOVEMBER 1990

# CLOACAL vs. TRITREME PLUMBING

CLOACAL VS. TRITREME PLUMBING

By Peter Kokh

### The Best Plumbing System for Lunar and Space Settlement Biospheres?

**cloaca:** (clo AH ka) = a common cavity into which the intestinal, urinary, and reproductive canals open in birds, reptiles, amphibians, and monotremes (the lowest order of mammals).

**monotreme:** (mo NO treem) = either of the two remaining species (duck bill platypus and spiny anteater) of the lowest, most primitive order of mammals, with one hole for all discharges.

**SCENE:** the lower Indus Valley about 200 miles NNE of modern Karachi, in the north part of Sind province, in what today we know as Pakistan.

**TIME:** some 4,000–4,500 years ago.

**PLAYERS:** a people, long since vanished from the area, but with increasing evidence that they were the ancestors of the populous dark-skinned peoples of today's southern India: the Dravidian speakers of Tamil, Telugu, Kanarese, Malayalam.

**ACT I:** fade from the ruins we see today, and known to us as Mohenjo Daro, back in time to one of mankind's first experiments in urban settlement – we do not know by what name its inhabitants called it – where the city fathers meet to accept the plans of their chief urban architect for the world's first urban sewer/drainage system: a network of gravity-gradient open ditches, into which all liquid-born wastes would flow off to same final place of out-of-sight/ out-of-Mind.

**ACT II:** there never has been an ACT II. Ever since Mohenjo-Daro, except for putting the sewer and drainage system underground and treating the effluent so that it commits less aggressive harm against neighboring communities, we have been in the rut of the very primitive duck bill platypus, stuck using a cloacal system to handle the quite different wastes from toilet (septage), bath and laundry (gray water), kitchen, and industry. Lessons for the "New Towns" of Space



Except in "new towns," it would be prohibitively expensive to switch to a new 'multi-treme' system which keeps different types of sewerage separate from the beginning in order to benefit from simpler and more efficient source-appropriate forms of treatment, with the fringe benefit of enjoying whatever valuable byproducts such separate treatment may promise. Lunar and space settlements are "new towns". Infrastructure is 'change-resistant'. Therefore it is of supreme importance to choose it wisely from day one.

While in many other areas NASA has chosen to pioneer radically new technologies, the agency, and those involved in the 1977 Space Settlement Systems Summer Study, turned instead to existing urban models when it came to the basic architecture of plumbing and sewerage treatment systems. If you think of the opportunities for Earth-side spin-offs, this decision emerges as a major slip-up.

Let's explore the benefits of an alternative triple conduit or tri-treme drainage and routing system for future off-planet mini-biospheres.

- 1) **Farm, garden, and lawn run-off**, food processing waste and kitchen garbage disposal waste (if not saved to compost for home gardens): the water laden with them should be kept separate by a distinctively labeled and color and/or design-coded drain and conduit system. After sieving out larger chunks for composting, such water can empty into fish tanks without further treatment.
- 2) **Gray water from showers, hand- and dish washing**, and laundry would similarly have a privileged routing system, to a treatment facility which would remove whatever biodegradable soaps and detergents are allowed, for composting separately. The remaining liquid could be run during dayspan through shallow near-surface ponds, top-paned with quartz, where 'raw' solar ultraviolet would sterilize it, killing all pathogens and bacteria. Simply cleansed and purified with the biodegraded cleaning agents added back in, this nutrient-rich water could go directly to farming areas and into the drip-irrigation system.
- 3) **Septage (urine and feces)** can be handled next in several ways. The familiar very water-intensive water-closet flush toilet system could be preserved, connected to its own drainage net. Solids could be removed to be channeled through an anaerobic digester for composting and methane production [see "Methane" below], and suspended particles in the waste water treated by microbes to produce milorganite type organic fertilizer. The clarified effluent would then go to the farm watering system. Or, the urine and fecal water might alone use a third drain line system, while fecal solids are 'collected' for separate treatment. [See "Composting Toilets" below].
- 4) **Industrial effluent** must be purified and reused in a totally closed on site loop with a high price for any loss makeup water piped in. Allowing industries to discharge water, of any quality, into the public drains system, invites them to pass on clean-up costs to the public. If all industries must play by this same rule, and cost out their products accordingly, there will be no problem with this make-or-break provision.

The 1977 NASA study recommended the use of a wet-oxidation (euphemism = incineration) process for treatment of all water-carried wastes indiscriminately. While this method almost certainly offers the swiftest turn-around for our costly original investment of exotic (= Earth-sourced) hydrogen, carbon, nitrogen, and possibly added phosphorus and potassium, on the order of 1-1.5 hours, it misses valuable and elegant opportunities to produce 'organic' fertilizers and other regolith-soil amendments which are far superior to chemicals in their buffered slow-release of nutrients and in soil conditioning character.

In smaller space and/or lunar outposts, heavy reliance on chemical assistance for fast-cycling sewage treatment may be the only feasible way to go. But as we design settlements for hundreds or more pioneers, we have the opportunity, if not the duty, to consider more natural alternatives. Every part of our proposed tritreme drainage and sewage treatment system, has separately received abundant proof of concept on Earth. **MMM**

## LOWERING THE THRESHOLD TO LUNAR OCCUPANCY

[Hostels]

[A paper presented at the International Space Development Conference in San Antonio, Texas, May 26, 1991 – here serialized in three parts for MMM]

Online: [http://www.moonsociety.org/publications/mmm\\_papers/hostel\\_paper1.htm](http://www.moonsociety.org/publications/mmm_papers/hostel_paper1.htm)

[http://www.moonsociety.org/publications/mmm\\_papers/hostel\\_paper2.htm](http://www.moonsociety.org/publications/mmm_papers/hostel_paper2.htm)



### HOSTELS: An Alternate Concept for both First Beachheads and Secondary Outposts

Peter Kokh, Douglas Armstrong, Mark R. Kaehny, and Joseph Suszynski – Lunar Reclamation Society

#### FOREWORD

Our purpose here is to outline an approach which will promote more timely, and wide ranging human presence on the Moon. In the event that the nation does not commit itself to a fully equipped Lunar Base, the hostel approach described herein could offer a less expensive alternative, a minimal but functional “tended beachhead”, a humble yet significant step beyond the Apollo achievement. “Hostel”, a term for sheltered sleeping space available to traveling campers, here refers to a pressurized structure offering minimally and inexpensively furnished “Big Dumb Volume” space for the private and communal use of visiting staff.

The concept cosignifies a visiting vehicle to be close-coupled to the hostel for the duration, to provide a complementary “Small Smart Cranny” component. Such a partnership promises to allow hostel and vehicle to function conjointly as an integral, reasonably complete outpost in support of exploration, scientific research, prospecting, and processing experiments, allowing longer, more comfortable stays at minimum expense. In some later time of expanding presence, roadside hostels would facilitate safer, more regular travel between fully equipped distant outposts or settlements across the globe. By not duplicating equipment and facilities that are standard equipment aboard the visiting spacecraft, both the total amount of cargo landed on the Moon and the number of crew EVA hours necessary for establishing a given level of capability, are minimized. Thus the hostel approach has the potential to keep the economic threshold for an initial operational beachhead significantly lower than in other mission paradigms.

#### Our objectives are four:

1. **Define the logical division of functions between visiting vehicle and shelter,** and how these differ with the particular purpose of the hostel and the prospects for its future
2. **Define design constraints on the visiting vehicle.** Such co-design will be necessary if the potential of the hostel approach is to be realized
3. **Outline logical paths of evolution towards stand alone status**
4. **Examine possible architectures,** whether for prefabrication on Earth or for construction on the Moon using native materials.

During the six Apollo Moon landings, the landing craft did double duty by offering minimal camp shelter on the exposed surface. The Lunar Excursion Module, or LEM, offered hammock-type sleeping and enough floor space to permit two whole steps at a time in a single direction. No one has yet slept in a bed on the Moon, or taken an indoor walk, basic humble everyday functions. As shelter from the elements, this Grumman-built lunar camper protected

those within from the incessant soft mist of micrometeorite infall and from the Sun's ultra-violet rays. It actually offered negative protection from cosmic rays or the occasional solar flare, for its thin unshielded hull served as a source of troublesome secondary radiation.

After a lengthy retreat, we now propose to return in style with a fully shielded permanently staffed base complex long on scientific and experimental capability and exploration support, but short on personal and communal space. Several missions would be required to set it up and render it operational As has proven to be the case with the Space Station, such overreaching skip-step designs must inexorably work to defeat the timeliness of their realization. Is there indeed a middle ground, a reasonable set of design choices which will lower that threshold enough to let us get on with the show within this generation? The hostel paradigm combines the complimentary assets of a relatively inexpensively equipped but more spacious shelter space with base-relevant compact and expensive standard equipment aboard a coupled visiting spacecraft or other vehicle in a synergetic partnership that allows the two to function together as an integral "starter base". The hostel paradigm is offered as a strong statement, even a protest, about the need for more elbowroom in lunar outposts than the more orthodox approaches can affordably provide. But to evaluate the feasibility and practicality of the hostel concept, we have to explore both sides of that special relationship, consider how this dynamic balance may change over time, and suggest how it might be realized in the concrete.

### I. THE VISITING "AMPHIBIOUS" VEHICLE

#### Design Constraints

The design and outfitting of the visiting vehicle is critical to the workability of the hostel concept. The visiting craft must close-connect with the hostel structure if the facilities and equipment it brings are to be used to support any sort of practical routine, and the linked pair are to function together in an integral way. Exercising reasonable precaution, a visiting spacecraft would land a prudent distance from the waiting shelter. Even bridged by some sort of pressurized passageway, the tens or hundreds of meters between would prevent efficient use.

Thus craft must be designed (a) to "taxi" en masse to the porch step of the hostel, or (b)\* to lower a conveniently underslung detachable crew compartment, with its relevant equipment, to the surface so that it can separately taxi the distance on a chassis provided for the purpose. We suggest that this is the design choice to make, as it leaves the unneeded and ungainly landing frame, with the rocket engines and primary tankage, sitting on the pad site. When the crew's visit to the hostel is completed in a couple of weeks or months, this mobile cabin would uncouple from the shelter and taxi back to the pad site, reconnecting to the waiting descent/ascent portion for the trip back to LLO or LEO. To highlight the amphibious space/surface character of such a vehicle configuration, we have dubbed it the "frog."

Figure 1: The amphibious "Frog"

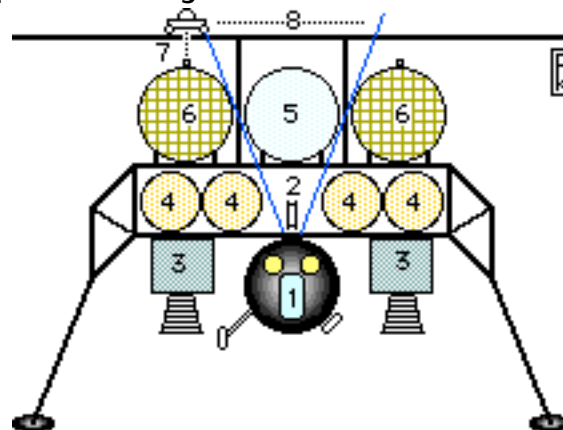

#### KEY:

1 Frog (detachable mobile crew cabin) wheel on right retracted, wheel on left extended

- 2 Winch to lower/raise frog    3 Main rocket engines    4 Fuel tanks –
- 5 Oxidizer tanks    6 Cargo pods    7 Overhead crane/winch for cargo
- 8 Central clear-vision area for top viewport navigation

**Figure 2: Generic Sketch of Hostel Concept**

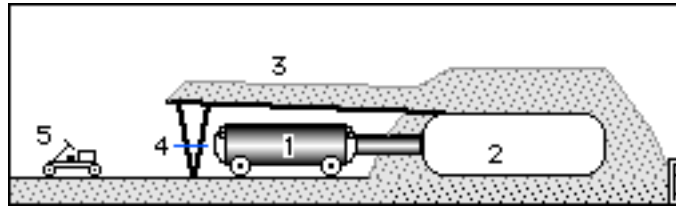

**Frog vehicle docked/coupled to Hostel under shielded open-vac canopy for duration of crew visit.**

- 1 Frog – 2 Hostel – 3 Canopy – 4 EVA airlock – 5 Open-vac rover

### **Frog vs. Toad**

The descent/ascent stage could also be designed to take off without the crew module, picking up a new one at LLO or LEO. The original crew compartment vehicle would continue to serve as a lunar surface transport. This “toad” version, would require a more rugged chassis, more serviceable engine, and some sort of refueling arrangement. If we are to settle the Moon in a self-leveraging way, “toads” introduced to serve remote outposts, may be the ideal ‘dues-paying’ way of importing the surface craft needed before the settlement is able to self-manufacture its own coaches. Thus, whether the crew’s came through open space or across lunar terrain, the vehicle that actually couples with the hostel structure will be functioning as a surface vehicle at the time.

The frog/toad/coach arriving on site could (1) be designed to hard-dock, in which case it must (a) be able to level, orient, and align itself properly for the task, and (b) be able to either lock or deactivate its suspension, perhaps with retractable legs. (If the suspension were allowed to continue floating, the hard-dock seal would be under continual stress with personnel moving back and forth.) Alternately, the vehicle could (2) be designed to link-up with the shelter via a somewhat flexible and alignment-forgiving, short pressurized vestibular passageway (a) extending from itself to the shelter, or more logically (b) tele-extended from the shelter to itself by a prompt from within the vehicle. There would seem to be engineering, weight, and safety tradeoffs between these hard- and soft-dock options and we do not suggest which would be the more practical in the short run..

[One criticism of our frog concept brought to my attention at the conference was that, as illustrated, it involved a pair of widely separated engines, one to either side of the centrally suspended mobile crew pod, introducing potential instability if either engine had to be shut down for any reason. Our response is simply that there is so much to be gained by using frog-like vehicles – however they be configured – that it is very much worth the trouble to find or develop engineering work-arounds of this problem feature (e.g. a single top center engine with the exhaust split between pod-flanking exhaust bells). By hook or by crook, there has to be a way! – PK]

### **Outfitting constraints**

To play its part, the coupling vehicle be out-fitted in a way that the capabilities it offers are complementary to those offered by the hostel shelter. It would seem that the repertoire offered would vary according to the customary length of trip for which the vehicle was designed. The possibilities suggest two general classes, the ‘commuter and the traveler.

(1). **Commuter class vehicles** would include shuttle craft plying between the lunar surface and either an orbiting depot or a more substantial orbiting mother craft such as an Earth to Moon (or LEO to LLO) ferry. Also fitting the description would be suborbital hopper linking mutually remote lunar sites. In either case the commuting craft is occupied for only a

few hours at time. Thus it may not contain berth space, galley (though food stores are likely to be a major part of the cargo), or head, though some emergency-use only arrangements would be a prudent option should the craft go astray or be forced to land far from its destination.

Even here, we have a vehicle which could bring something to a hostel partnership. For both shuttle or hopper will have communications, navigation, and computing equipment which do not need to be duplicated in the hostel. And either will likely have an emergency first aid compartment complete enough to serve the crew in its hostel stay, as well as other emergency survival provisions. Finally, its air recycling equipment (a water recycling capacity is less likely) and ventilation fans, might easily be oversized without too much weight penalty, so as to also serve the hostel space well enough in a close-coupled configuration.

(2). **Traveler class vehicles** would include such landing craft comprised of a shuttle module delivering a “through-cabin” crew-pod transferred from an Earth-Moon (LEO-LLO) ferry. As on the coast to coast Pullman sleeper cars passed on from one railroad to the next in an era now long gone, the crew coming to staff the hostel would ride the same “through-cabin” all the way from LEO, or even all the way from the Earth’s surface.

Also in the cruiser category is the “overland” coach (from an established settlement or full base) designed for trips cross-lunar excursions of a day or more in duration. In either scenario, the visiting craft will contain serviceable if cramped “hot-rack” berth-space that can serve in the hostel-hookup as emergency infirmary beds if isolation or quarantine is called for. And certainly the craft will have at least a minimally equipped galley and head (possibly with shower) as well as a compact entertainment center with some recreational extras. Such more fully equipped vehicles would serve especially well as hostel complements, leaving the hostel to provide what it can offer most economically and efficiently: hard shelter from the cosmic elements, and plenty of elbowroom to serve the less expensive low-tech but space-appreciative aspects of daily life -- private bedrooms and communal areas for dining, gaming, exercising, etc. <<< LRS >>>

MMM # 49 - OCTOBER 1991

## LOWERING THE THRESHOLD TO LUNAR OCCUPANCY



### HOSTELS: An Alternate Concept for both First Beachheads and Secondary Outposts II. THE HOSTEL'S SHARE OF THE WORKLOAD General Philosophy

Approaching the suggested vehicle-shelter functional partnership from the point of view of the hostel itself, we must keep in mind both the economies to be gained by keeping the shelter as low-tech and inexpensively simple as possible while still serving its purpose, and the competing consideration that we might want it to design it so it can evolve over time into a fully configured autonomous base. The underlying concept of the lunar hostel is that base functions can be physically and spatially separated into two broad types.

(1) Cranny-loving functions. The first includes the compact but expensive equipment that is needed to maintain human existence outside our native biosphere, to maintain the health of the crew, to support the crew's scientific and exploratory research tasks, and to maintain contact with the rest of humanity from which it is physically isolated. The whole evolution of vacuum-worthy craft has been to make such equipment ever more compact and lightweight while ever more functional, productive, and capable. This first category thus

principally includes those things that the crew must always have access to, whether it is settled-in on the Moon, or in transit between Earth and Moon, or simply orbiting the Earth.

(2) Room-loving functions. In contrast, there is a second broad category of functions which principally includes those things that are not missed in the short run (and so need not be provided for periods of the order of Earth-Moon transit times or shorter) but are needed over the long term (and thus are ideally provided by durable in-place shelter to be visited for extended periods.

These are the functions which, because we lacked the lifting capacity or out of sheer economic necessity have been at best shoe-horned-in on spacecraft and orbiting stations, but which for personal and group morale and psychological well-being should really be offered on a far less space-stingy basis: honest to goodness personalizable private quarters with ample space to move about, arrange one's personal effects, display (if only for oneself) any personal treasures or hobby-work; pleasant dining, assembly, and meeting space (wardrooms); quiet places for reading; places for shared entertainment or gaming; places for space-hungry exercise routines.

These long-term needs were necessarily ignored on Mercury, Gemini, and Apollo because the space to serve them could not be set aside. Nor have such spaces been more than suggestively and teasingly provided on the Shuttle or even aboard the relatively voluminous Sky-Lab. True, sardine-can packing can be sustained even for months if there is light at the end of the tunnel, as ample submarine experience has demonstrated. Yet it hardly contributes to morale.

More to the point, such elbow-to-elbow jostling may prove to be much less tolerable over any length of time in settings where the outside environment is one of unsurvivable desolation, however magnificent; where a play of sterile grays and blacks, is nowhere relieved with soft and friendly greens and blues; where there is no wildlife to be found at all, not even 'alien'. Space Station planners have endeavored to give some consideration to these needs, exploring design innovations that might make the station's unavoidably cozy spaces more human.

Since on the Moon, the task of maintaining individual and communal morale and mental health will be much more challenging than in low Earth orbit, if there is a way to provide both more generous private and communal space – not just workspace – without undue expense, it should be prioritized. It is our premise in this paper that by not unnecessarily duplicating equipment and facilities already needed aboard the visiting craft to sustain life in space, appreciable dollar and fuel savings can be gained which can be spent to this purpose.

### **Gray Areas**

Before we consider how in the concrete such liberal camp space shelter can be offered (that is, building materials, construction methods, architectures, and deployment options), we wish to consider some gray areas, facilities and outfitting whose proper placement – in the coupled visiting craft or in the hostel space – might be debated. We did not attempt to reach definitive answers. But in each case we list considerations that seem pertinent.

**(1) Communications/computer center:** The need for redundant systems is inarguable. But their placement may be a matter for dispute. Accepting that the hostel would never be occupied without a visiting vehicle coupled to it, one might still argue that the various systems aboard the visiting craft necessary to maintain life and contact with metropolitan humanity should be duplicated within the base structure itself as a matter of simple precaution. Here one should keep in mind that spacecraft systems are already by themselves provided redundantly. But the point might still be made that the coupled spacecraft is unshielded and therefore could be knocked out by a rare meteorite of sufficient size. A testy rejoinder would be that anyone that concerned about remote possibilities, doesn't have 'the right stuff' and shouldn't volunteer for such duty.

But accepting the challenge made, we can more constructively reply that it would be possible to offer shielding protection, not to an intact conventional lander, but to the



detachable crew-compartment become bus (i.e. the frog or toad), under a shielded but vacuum-exposed carport-like canopy extension of the hostel structure. Such a “ramada” would also shield routine doorstep and porch outside activities: outside vehicle maintenance, storage areas for surplus supplies and discarded items; items awaiting shipment, etc.. But if such sheltered parking space is provided, the vehicle’s antenna would be effectively blinded. Therefore the hostel must be equipped with the necessary antenna(s) for joint operation.

**(2) Electric Power Generating Capacity:** The power systems aboard the docked vehicle will be sufficient to take care of its own needs in transit, probably via fuel cells with a couple of weeks of emergency reserve power at best. While the activities the hostel itself is designed to support within its own confines will consume relatively little power, and even less to run whatever minimal housekeeping equipment, if any, is needed in between visits, we are left with some real challenges.

**(a) Compact workstations** aboard the vehicle may need more power when the vehicle is parked and functioning as an integral part of the base combo than when it is in transit.

**(b) If the landing vehicle does have a modest solar power array, this is most likely to be a part of that apparatus left on the pad.** Connected to the detachable crew compartment or frog, such arrays might be effectively disabled if the frog docks with the hostel underneath a shielding canopy out of sunlight’s reach, as recommended.

**(c) Nightspan power needs must be taken into consideration,** even if these are minimized by apportioning base operations into energy- vs. labor-intensive tasks reserved for dayspan and nightspan respectively.

Thus for a stay of any real duration, the location within the integrated base (frog or hostel) where the power is actually consumed becomes irrelevant. The apparatus to generate it and store reserve supplies will be weighty, no matter which path is taken. Therefore principal power generation and reserve storage must be the contribution of the hostel component, with the apparatus necessary a part of the original hostel endowment package. This hostel-provided power system could also electrolyze whatever water that had been generated in the frog’s fuel cells en route to the hostel, so that its hydrogen and oxygen fuel reserves were fully replenished for the return trip. Any surplus gas could be stored in shielded tanks outside the hostel as a handy and welcome fuel/water reserve for the next visitation. Under this arrangement, fuel cells aboard the frog, which would go off-line for the duration of the coupling, would be fully available as backup for short routine repairs to the principal system or for ‘mayday’ emergencies.

**(3) Air Quality and Ventilation:** Any crew-rated spacecraft is going to have redundant systems serving this need. It would seem that it would be cheaper to oversize these aboard the visiting vehicle so as to handle the extra coupled volume, than to install separate and independent air management systems in the hostel. However, it may be necessary to put complementary equipment in the hostel to dehumidify and sterilize the air within after the crew departs, so that the next crew to visit doesn’t walk into a dank and moldy place. An automatic cycle that would dehumidify and then heat the air to perhaps 70° C for a relatively short time would possibly do the trick, allowing the air to stand without further treatment or control until the next visit when a short, perhaps vehicle-assisted procedure would restore the proper humidity, temperature, and ionization level. This still allows the bulk of the equipment needed to treat air currently being used to be housed by the visiting craft.

**(4) Thermal Management Systems:** This need includes tasks that could be appropriately apportioned between the partner elements. With suitable architectural attention, the hostel could be built and shielded to be thermally stable. Between occupations, the hostel could either be designed so that the interior temperature falls to that of the the surrounding soil blanket (-4°F or -20°C). Alternatively, the hostel could be designed to harvest and store heat from dayspan sunlight so as to coast at some higher but still level still on the cool side but from which recovery to (and maintenance of) comfortable room temperatures will be easier and

quicker. Most of the activities for which the hostel space is designed to make room should generate little heat. If the coupled vehicle is parked under a shielding canopy, extensive heat rejection arrays for excess heat generated within might likewise be unnecessary. But if a thermal surplus is expected nonetheless, the radiators indicated would best be a hostel feature, easily integrated with a solar array, or possibly placed on the permanently shaded underside of attached ramada areas. Meanwhile, the control apparatus could be housed in the visiting vehicle if it doesn't require much space, since the vehicle already houses ventilation and air quality apparatus which would have to be integrated with the thermal management system.

**(5) EVA Airlock and Open-vac Rover:** An air-lock for suited exit onto the surface needs to be a part of any functioning lunar base. For this purpose, if the visiting crew vehicle already has its own EVA airlock as standard equipment in addition to its docking adaptor, as seems likely, this should serve the joint vehicle-hostel operation quite adequately. The hostel need only have a docking adaptor and connecting vestibule with which to interface with the visiting vehicle. Personnel would then exit onto the surface through the coupled vehicle. Again the hostel would not be occupiable without the pressurized vehicle attached, and any contingency which is likely to make the latter unusable or unenterable, is likely to doom the combined base at any rate. In sum an additional airlock as part of the hostel proper, would be an option of definite eventual value but not an immediately pressing need. If not original equipment, such an accessory could be added latter, as part of a docking port extension, as increasing use of the facility and the prospects for its evolution into a fully equipped base warrant. For exploratory sorties to nearby spots of geological interest of resource potential or for recreational change-of-scenery jaunts, a separate unpressurized Apollo-type rover would be carried along by the first vehicle to visit the ready hostel, to be left on site.

**(5) Recirculating Water Systems:** These, along with waste water treatment equipment are unlikely aboard visiting commuter-class vehicles, but plausible in traveler-class ones for which the hostel concept is properly tailored. If the prospects for the particular hostel to be transformed into a permanently staffed autonomous base are positive, such systems will be an early addition to the hostel's offerings. But at the outset, almost by definition, the vehicle will be wet, the hostel dry. This implies the following:

**(a) Toilet and personal hygiene facilities** will be offered in any non-commuter type craft, in which case installing additional plumbing and waste treatment facilities in the hostel space from the outset would seem to defeat the purpose. But carry-in-and-leave convenience plumbingless toilets that shunt their wastes to external shaded holding tanks where they will freeze, are to be recommended for placement within the hostel space if they can be designed so as not to need special venting. For the alternative of keeping the wastes sealed within tanks aboard the visiting vehicle, presumably for disposal in space or for return to Earth, would not only add to takeoff weight unnecessarily, but would constitute almost criminal waste of what, on the Moon, will constitute an invaluable exotic volatile-rich resource to be husbanded with care. Even before the onset of lunar agriculture, which could compost such wastes and recycle them so as to enrich the regolith-derived soil, it will cost nothing but storage containers to bank these wastes, inertly frozen, until that day does come. Even if a particular hostel site is not destined to become a full-fledged base or settlement, its stored freeze-stabilized wastes could be collected at any convenient later date and transported to wherever they can be used to enhance on-Moon agriculture.

**(b) Food preparation and dining** would seem to another task apportionable area: the food preparation, scrap handling and dish washing capability of the vehicle's galley need not be expensively duplicated; relaxed casual dining complete with 'atmosphere', can be cheaply arranged within the hostel's more spacious setting. The vehicle may have a locker for the fresh food supplies it has brought along for the mission. But a pantry for long shelf-life contingency rations would logically be put within the hostel along with a snack bar.

**(c) Laundry tasks** may also be apportioned. Given the water treatment and recycling facilities on the vehicle, if crew stays were long enough to make laundering desirable or

necessary, and if space could be found in the vehicle, that would seem to be the logical choice for washing. Clothes drying could easily be done anywhere within the hostel, which might even have space enough for hanging items 'out' to dry, if such an option did not burden humidity control. If the planned hostel stay is sufficiently short to make laundering unnecessary, each crew could simply bring in their own fresh clothes and bedding, taking the soiled items with them when they left – in keeping with a recommended leave-as-you-found-it, bring-with/take-with honors code protocol. But alternately, soiled fabrics could be allowed to accumulate in shielded but sterile vacuum outside so that their exotic and precious imported carbon content would remain on the Moon as an endowment, to be reused or recycled in some existing or future settlement. Replacing carbon-rich fabrics from Earth with new goods will be marginally less expensive than bringing soiled items all the way back, then returning them to the Moon cleaned.

**(7) Medical Facilities:** Medical care presents another gray area. Cabinets of medical supplies and common procedural implements, especially those needed to handle accidental injuries and trauma cases as well as the more common fast-developing transitory ailments, are likely to be standard features of any visiting craft. The hostel, in turn, offers roomy bed-space for patients. This allows any much less generous berth space aboard the coupled vehicle to be pressed into service where isolation or quarantine is advised, even as sealable morgue space if need be.

But expensive, diagnostic equipment, compact or not, with the instruments and medical supplies needed to handle the full range of more plausible eventualities is something that may not be provided at all at first. Such a level of medical capability might be added later, however, and preferably within the hostel itself as the frequency and duration of visits increases. If any of the personnel must be returned to Earth for medical reasons via the coupled vehicle, everyone else must leave as well; for in the coupled vehicle/hostel scenario the hostel, by definition, is not configured to function separately. It will be a principal priority in the evolution of the particular hostel, to minimize the likelihood of such premature abandonment.

**(8) Workstations and Laboratories:** Provision for geological and mineralogical analyses is a primary design criterion. And the need for facilities to support lunar materials processing feasibility studies will be of increasing importance as the human return to the Moon becomes more earnest. The first relevant consideration is whether the proposed workstation is wet or dry. The second is whether the supported research can be done in a compact space or needs extensive floor/wall space.

The logical division would locate compact testing and analysis work stations, wet or dry, aboard the visiting craft. This would allow convenient changeout and updating of equipment on return visits to Earth or Earth orbit. "Dry" research needing extra space can be provided within the hostel structure proper. "Wet" research or experimentation needing extra space should be examined to see if the wet and dry tasks can be separated by location without too much convenience. If so, the dry part of the operation would have a claim to hostel space conveniently near the docking passageway. The hostel, in turn, would offer inexpensive and liberal sample storage lockers, and sorting and display areas.

But in deciding where to house various workstations, we must also take a more comprehensive look at the mission context of such hostel-stays. If there is more than just one hostel site for a single vehicle to visit, it will indeed require less expensive duplication to provide such space aboard the vehicle, so long as the equipment involved is not particularly massive. If, on the other hand, we are dealing with a single hostel visited by a small fleet of similar vehicles, it would require the least duplication to put such workstations within the hostel structure proper. Again, if each frog is specially equipped to support a particular research agenda that changes with each stay (as has been the pattern with Space Shuttle missions to date), the pendulum swings in the other direction. The question cannot be fully resolved outside of the mission context and the hostel's continuing evolution through use.

If in general, most workstations are in fact built into the visiting vehicle, reserving the hostel principally for off-duty functions, such a segregation of activities would lend itself especially well to shift-scheduling, with on-duty personnel clustered in the vehicle, and off-

duty personnel within the hostel. A two shift setup with shared social time might prove the most workable and best for group morale. Whether such a separation of activities by area is practical or not, we suggest that the passageway space, short or long, connecting the two areas of the outpost combo, be designed with sound-buffering in mind. However all such considerations are secondary in deciding where each workstation should be.

**(9) Exercise Areas and Equipment:** These are best placed according to the nature of the activity in question. While some daily ritual types of exercise need little room and can be performed in a compact exercise area within the vehicle such as the wardroom area, other exercise routines are space-hungry; to provide for these, any portable equipment needed could be brought into the hostel and left there. The hostel's interior spaces and overall architecture might conceivably be designed and arranged to incorporate a banked peripheral jogging track, or even a "sixthweight" caricature of a bowling lane. A billiards or ping-pong table, even a handball court are imaginable, given enough cheap dumb volume.

**(10) Entertainment and Recreation.** The visiting craft will doubtless possess its own entertainment console and a modest audiovisual library. Small personal audiovisual consoles would be an inexpensive and welcome feature for the private quarters within the hostel. With ample space, separated communal viewing and listening/reading areas could be provided. Additions to the hostel's audiovisual library, extensive reading materials on CD-ROM, [written before the arrival of DVD technology] even a modest collection of low-weight art pieces, could be carried in and contributed by each new visiting crew, continually enriching the cumulative samples of Earth culture available on the Moon.

**(11) Exterior Visual & Interior Solar Access:** Visual access to the surrounding moonscape would also foster psychological well being. The portholes in the coupled vehicle serving navigation and driving needs are likely to provide only restricted views. Windows or view screens are likely at both ends of a frog-type craft. Side-wall portholes may or may not be offered.

If feasible, then, the hostel structure ought to provide visual additional and more possibly more panoramic visual access as well. A technique already demonstrated on a low-tech basis in one Earth-sheltered home in the Kettle Moraine region of southeastern Wisconsin, in which pairs of angled mirrors bring in stunning picture-window views of the surrounding countryside through zigzag shafts, which duplicated on the Moon would conveniently block cosmic rays. This suggests a design approach for hostel architects desiring to visually integrate the hostel's interior spaces with the surroundings. Pulling off the same trick while preserving pressurization against the hard lunar vacuum will require architectural/engineering ingenuity, but seems doable. Such a feature might be more easily built into Lunar hostels constructed on site of local materials.

This would also seem to be the case for solar access, channeling in pools of soul-warming sunshine via a sun-tracking heliostat using either a zigzag mirrored shaft or a 'solid' fiber optic bundle to preserve shielding integrity. The shutterable sunshine thus brought in can be used to highlight focal points or for general lighting during the dayspan. Both of these features may or may not be harder to provide in hostels partly or wholly pre-fabricated on Earth for transport to the Moon. But 'where there's a will, there's a way.' To the point, both options are relatively low-tech and space-eating features that can be more satisfactorily provided through the hostel's expansive structure than through the nook-crammed hullspace of the paired vehicle.

**Left: FROG VEHICLE FUNCTIONS**

**Right: INITIAL HOSTEL FUNCTIONS**

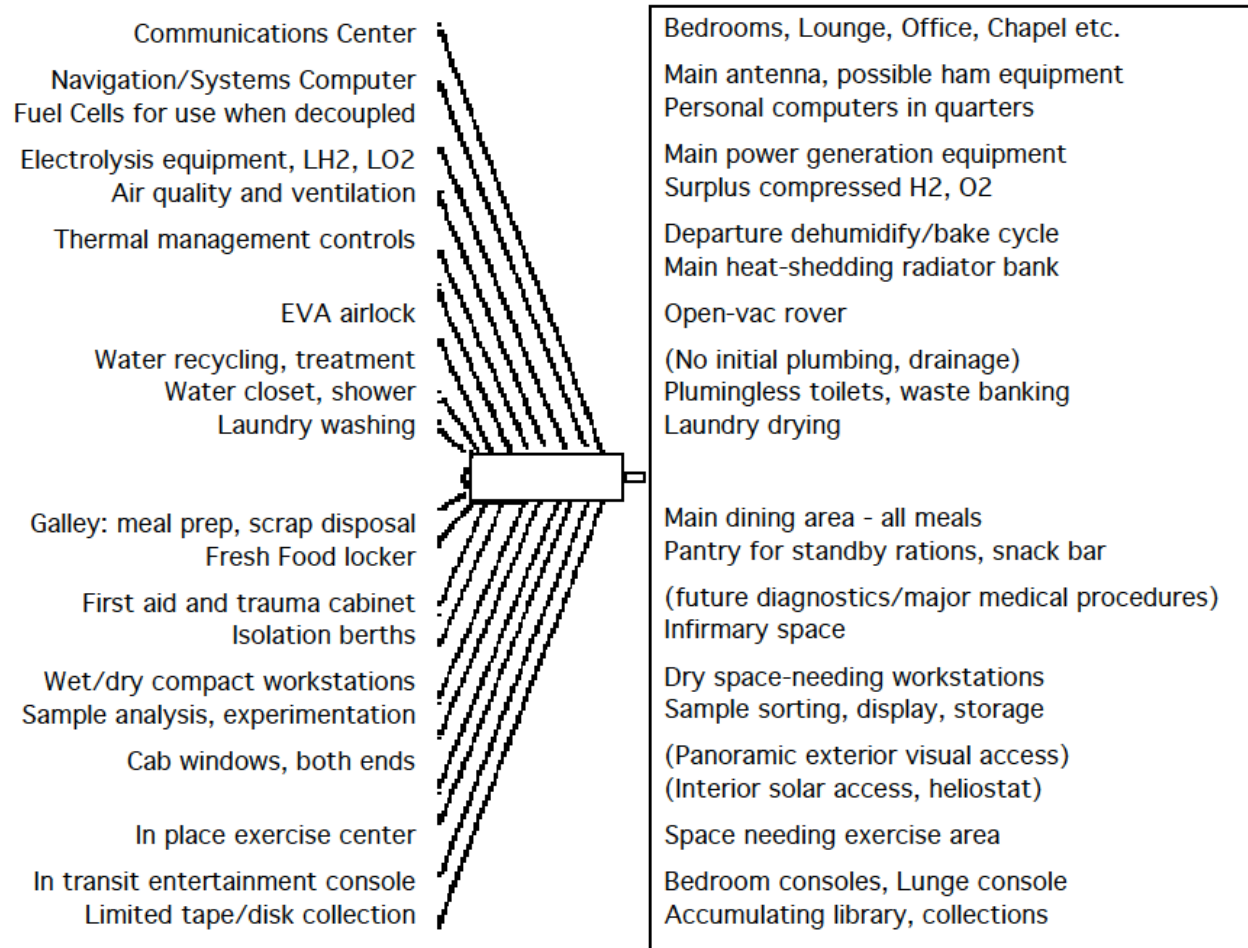

### III. EVOLUTION OF THE HOSTEL WITH USE

**(1) A First Beachhead:** If current more ambitious Moon Base plans have to be abandoned and our first beachhead on the Moon is based instead on this hostel-coupled vehicle concept, and if continuing site reappraisal confirms the decision to establish a permanently occupied full-functioned base on the site, two directions suggest themselves. 1) Provided that the architecture and design of the original hostel have been chosen to be expansion- and retrofit-friendly, with each new visit the hostel could be slowly evolved into the stand-alone full-function base desired. Crews would add floor space via plug-in expansion modules or, preferably, by additions constructed of on-site materials as soon as such a capability comes on-line.

Then would come installation of independent air management apparatus, plumbing and water recycling equipment, sundry work stations, laboratories and shops etc. More adequate medical facilities to treat a wider range of needs would be an early priority. The actual order of improvement would depend on logical dependencies, calculated to prioritize redundancy and safety and to allow an acceptably timely shift to permanent staffing. 2) But if the hostel's chosen architecture and design does not readily allow such expansion and evolution, instead of the hostel being wastefully dis-mantled or simply abandoned, it could be preserved as an annex of a totally new base built adjacent to it, serving to house guest visitors for whom the new base complex may have no spare room. That is, the hostel could become an attached hotel, the Moon's first. We suggest that in the case of a first beachhead, this is the preferred path.

**(2) A Farside Astronomy Station:** Our recommendation is different for a hostel designed to serve remote infrequently tended installations such as a Farside Advanced Radio Astronomy Facility (FARAF). Such an installation may well follow, rather than pre-cede the establishment of an original permanently staffed nearside Moon Base, so that the latter could be an advance logistical support node for the farside operation. Following this scenario, the hostel should be designed from the outset with planned expansion and evolution towards permanent autonomous staffing in mind, and an appropriate architecture chosen accordingly. Indeed, it was to show that there is a happy middle ground between the vehicle-tended farside minimalist installation envisioned by NASA and the permanently staffed major installation the astronomers would like, that we set about to develop the hostel concept in the first place.

The Farside hostel should offer more than basic off-hours shielding against the cosmic elements for technicians changing out equipment, repairing, and updating the facility. An expandable astronomical workshop should be an early extra if not part of the original structure, along with a garage and lunar pick-up or tractor. Such assets would make the visits of the tending staff far more productive, especially if limited to once or twice a year, the low level of activity NASA feels confident the agency can support (in lieu of a near-side base!). For as long as visits remain so infrequent, a stand-alone full-function base would be an exorbitant luxury. In contrast, a simple Big Dumb Volume hostel could justify itself with the first visit. And once such a hostel were in place with the appropriate special extras mentioned, the next crew to visit need bring only new and replacement parts for the astronomical installation, and be able to bring more of them, as they wouldn't have to keep hauling workspace and berth space to and fro with them.

Thus the original up front investment in a FARAF hostel, by allowing visiting vehicles to maximize their capacity to carry equipment for expansion of the installation, would promote more rapid growth and development of this facility within the same subsequent budget.

**(3) Remote Prospecting Camps:** Hostels serving prospectors may or may not develop into anything more. If the prospecting activity does not reveal enough promise and economic justification for further visits to the site, the hostel could be abandoned (to serve as available solar storm shelter or rest stop for anyone happening by) with little waste of investment.

Meanwhile much more extensive prospecting will have been made possible than from a solitary unshielded vehicle with the same size crew. Hostels at remote research and prospecting sites, like the one proposed as a first beachhead, will need to offer a fair amount of unpressurized but shielded work and storage area, to minimize radiation and micrometeorite exposure during routine porch step 'out-vac' activities. So housed repair and maintenance facilities for surface-ranging equipment would be a logical early addition.

**(4) Wayside Hostels:** A hostel serving as an 'overnight' rest stop and flare shelter along regular trafficways could be built and shielded in one of the ways suggested below for beachhead or research station hostels. But alternatively, such a hostel might simply consist of one or more linked towable mobile modules (perhaps settlement-rendered retrofits of surplus cargo holds or fuel tanks and other scavenged items) parked under the overarching shield of a previously constructed roadside solar flare shelter.

With the lack of right-of-way and clearance constraints on lunar roadways, such mobile units could be built much larger than their terrestrial forerunners. In either case, the roadside hostel may continue to function as originally set up, or, over time, grow to become the nucleus of an all new settlement, depending on the economic rationale offered by the particular location and the resources of those proposing to exploit any such perceived advantages. In that case, as with the original beachhead hostel, it could either itself be evolved and expanded, or kept as a 'motel' annex for the new settlement. A sheltering open-vacuum ramada for roadside vehicle and equipment repair would be a logical first improvement if not already provided, along with a standard-equipment tool and parts crib for user-performed work. A fuel cell changeout/water re-electrolysis station, a battery recharging facility, stocks of emergency provisions and first aid supplies, and standby emergency communications equipment, could follow.



In other words, the expansion, as warranted by traffic and location, would first proceed along the lines of additional user-tended facilities. Only later would regularly scheduled types of full-service be offered by dedicated staff: the truck-stop restaurant (slowly switching to supplementary onsite food production), the bed and breakfast motel, the on-duty expert mechanic, the souvenir-maker, and the inevitable practitioner of the 'first profession'.

In all cases, docking apparatus should be pre-standardized. If we are indeed going to develop the Moon as an integrated part of a greater Earth-Moon or circum-solar economy, the solitary first beachhead must give way to a multi-site world, and hostels will be at the forefront of that global expansion and acculturation. Any visiting vehicle, frog, toad, or coach, should be able to couple with any hostel.

Code of honor protocols governing visitor behavior should also be standard, expanding on the suggestion above.

As to architecture, building materials, layout, size, method of deployment or construction -- these could vary widely depending upon available technology, resources, logistics, prognosis for the future of the site, and innovating entrepreneurial competition.  
<LRS>

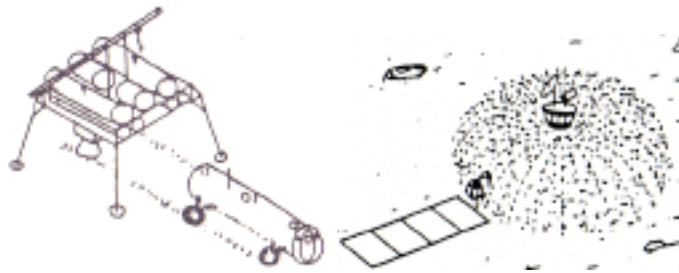

### The Magic of Symbiosis

Life clings to rocks in the frigid wastes of the arctic Tundra in the form of lichens, a symbiotic partnership of green algae and colorless fungus – neither of which could survive alone. Similarly, little smart “Frog” and big dumb “Hostel” might combine their assets to create a “full-function” lunar base. We examine the magic of this symbiotic relationship in depth in Part II of “HOSTELS” below.

MMM #50 – NOVEMBER 1991

## LOWERING THE THRESHOLD TO LUNAR OCCUPANCY



**HOSTELS: An Alternate Concept for both First Beachheads and Secondary Outposts**  
Peter Kokh, Douglas Armstrong, Mark R. Kaehny, and Joseph Suszynski – Lunar Reclamation Society

### IV. HOSTEL-APPROPRIATE ARCHITECTURES

The operative philosophy in making architectural and design choices for lunar hostels, is getting the most usable square footage per buck. Our intent is not to give an exhaustive treatment of the many possibilities by which prefabricated or built-on-site hostel shelter space can be provided. But we point out appropriate considerations that should affect the final choice in each particular case. We have attempted to illustrate some previously unexplored avenues.

## Hostels Pre-built or Prefabricated on Earth

(1) **Hard-Hulled Modules:** Lunar hostels established prior to the startup of settlement industry, would be unlikely to employ lunar materials except as shielding mass. That is, it will be necessary to pre-build them on Earth. But neither ready-to-use payload-bay-sized space station type modules, nor structureless inflatables seem ideal for the purpose. The former quite simply offer inadequate space and if brought up to the Moon empty, will squander payload bay capacity. Multiple modules stuffed with provisions and serving as temporary cargo holds, to be unloaded on the Moon, then interconnected, are a more reasonable possibility. But their deployment would call for an unwelcome load of high-risk crew EVA hours. The wiser course to reserve human activities on the Moon for tasks that can be performed under shelter. The modular approach does, however, allow the hostel complex to grow with each new visit.

(2) **“Telescoping” hard-hull designs** are another story. Prebuilt hostels of this type could be built to extend, unidirectionally or bidirectionally, with the smallest diameter section (1) being loaded with built-in features and the wider diameter telescoping sections offering simple unstructured spare volume. The inside walls of these sleeves could be furnished with electrical service runs, flush lighting, recessed attachment points, etc. Deployment would be accomplished via simple pressurization which would securely force together properly designed o-ring-fitted inner and outer flanges providing a seal with more than sufficient mechanical strength to maintain integrity under any likely interior traffic/use.

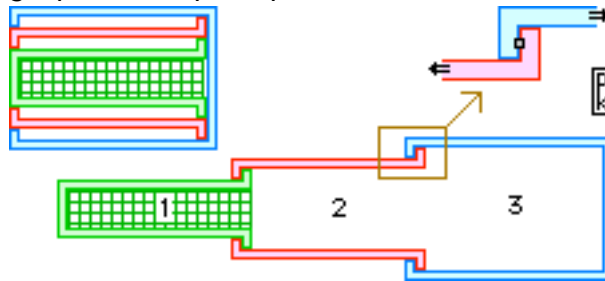

**Figure 3A: Telescopic Module:** The thickness of the sleeve walls, and the amount by which one is smaller than the other, is exaggerated to show detail.

Alignment would be preserved by the simple expedient of a key/keyway feature with keys on the outer flanges and keyways on the outer surface of the inner sleeves. Outrigger skid-dollies attached to the smaller ends and the outer flanges of the widest diameter middle sleeve, riding freely on a pre-leveled compacted gradeway, would midwife the deployment. Airlocks or docking ports could be placed at either end, but only the widest sleeve could have a side-mounted protrusion. A pair of bidirectionally expanding units could turn this to advantage to conjoin “H” style.

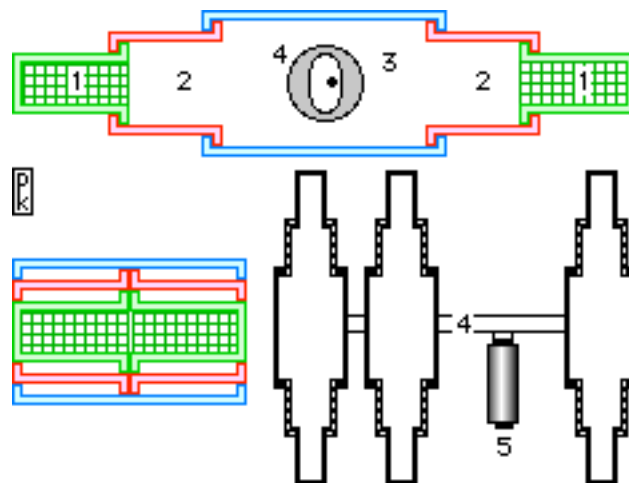

**Figure 3B: Bi-telescopic Module:** [4] connector tube. [5] docked frog, under a shielded canopy.

In fact, any number of such units could polymerize in like fashion. For this reason, we have dubbed the basic unit the “monomer”. The beauty of this bi-telescopic design is that it allows a single payload bay to deliver perhaps two and a half times its own usable interior volume. The apparent drawback of the strongly linear floor plan (and required special attention to site preparation) becomes a potential plus through H-H hookup possibilities. We think this telescopic approach to hard-hull modularity is much more promising than any of the more conventional segmented approaches. Indeed, such a configuration might also prove to be the eventual architecture of choice for full-function lunar bases and non-gravid orbital stations as well. Single units would be especially trailerable and might thus be ideal for manufacturing in the lunar settlement for trucking to roadside locations about the Moon, to be deployed under previously built emergency flare sheds.

**3) Simple Inflatables** come in spheres and cylinders, shapes with unstable footprints and awkward to work with if not pre-decked. In free space, the inflatable cylinder can be subdivided in radial cross sections, its caps serving as top and bottom. But on the Moon, one can only lay such a shape on its side, especially given the need for shielding. Then, as with the inflatable sphere, the inconveniently curved inside bottom surface has to be somehow decked over. Nor do pure inflatables lend themselves easily to even modest built in features and furnishings. An alternative we do not recall seeing treated, is the inflatable torus which would seem to offer maximum stable footprint per usable volume.

(4) **“Hybrid” Inflatables** were examined next. These are structures employing both hard, feature-loaded elements and soft inflatable sections.

a) **First we sketched a flat footprint “sandwich” model**

The “sandwich” has a prefab floor section with pop-up built-ins and utilities, paired with a prefab ceiling section with built-in lighting and pull-down features, the two slab units connected by a peripheral inflatable wall. (The curvature of the walls, providing maximum volume for combined flexible and rigid surface areas, would follow the lines of a projected cylinder of the same diameter.) Collapsed for trans-transport to the Moon, such a hybrid could offer clear flat floor space a full fifteen feet wide if designed to fit the Space Shuttle payload bay or up to 27 feet wide if designed to fit an inline (top-mounted) shuttle derived cargo faring. Such hybrids could be deployed with significantly less crew EVA hours, or even be tele-deployed. To the improvement in habitable volume as compared to the rigid module traveling in the same hold, the folded “sandwich” would make room for plenty of additional cargo, both by taking up less space and by weighing less.

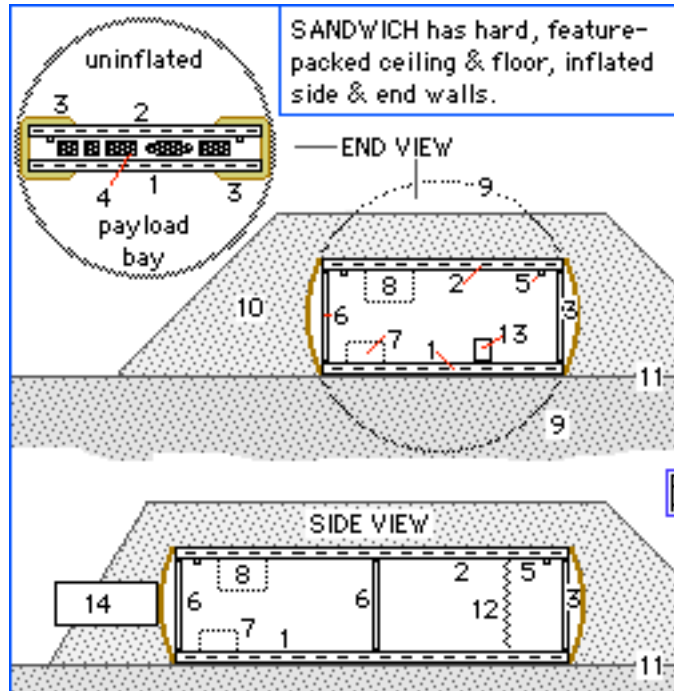
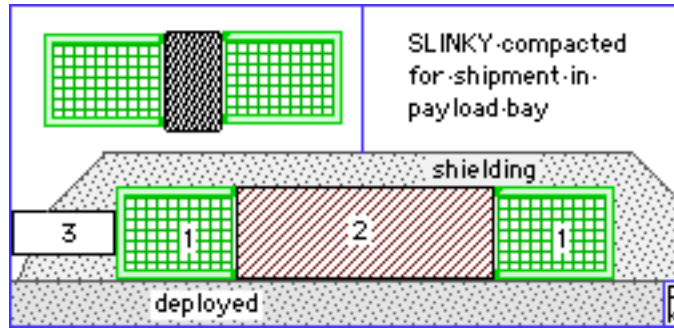

**Figure 4: The Sandwich:**

- |   |  |
|---|--|
| [1] Floor module with pop-up built-ins.         | [2] Ceiling module with pull-down units.       |
| [3] Inflatable sidewalls and end walls.         | [4] Collapsed loose furnishings                |
| [5] Cove-lighting tubes or bulbs                | [6] Contingency support poles & utility chases |
| [7] Representative floor pop-up feature         | [8] Representative ceiling pull-down feature   |
| [9] (Curvature of inflation extended)           | [10] Soil overburden for shielding             |
| [11] Original graded & compacted ground contour | [12] Pull-down pleated room divider            |
| [13] Representative loose furniture item        | [14] Docking tunnel                            |

While the great advantage of the sandwich design is that it offers a stable flat footprint and a ready to use flat floor, it offers little more than half again as much space as a rigid module designed to travel in the same cargo hold.

**Another configuration, which we've dubbed the "slinky"**, features rigid feature-packed cylindrical end caps connected by a cylindrical inflatable mid-section. Here instead of multiple circular ribs and worm-like segmented lobes, we strongly suggest using a continuous helical rib spiral, as this helical design choice offers an elegant opportunity to build-in a continuous electrical service run along with other utility lines and lighting strips within this skeletal "monorib."



**Figure 5: The Slinky:** [1] Pair of rigid end caps, outfitted with build-in features and equipment. [2] expandable slinky module (unfurnished). [3] docking tunnel.

b) Next we came up with a novel wide-floored lunar “quonset” idea.

The “Quonset” has a stable footprint and favorable width to height ratio. While all the built-in features would have to be floor-housed pull-ups, this design offers about two and a half times as much floor space as the “sandwich” for the same payload bay space. The inflation-reinforcement of a triple slab hinged floor is a design innovation that offers opportunities for crawl-space storage, utility space, and ventilation worth pursuing. A telescoping vestibular passage-way for vehicle coupling could be built into one or both inflatable end-walls as illustrated.

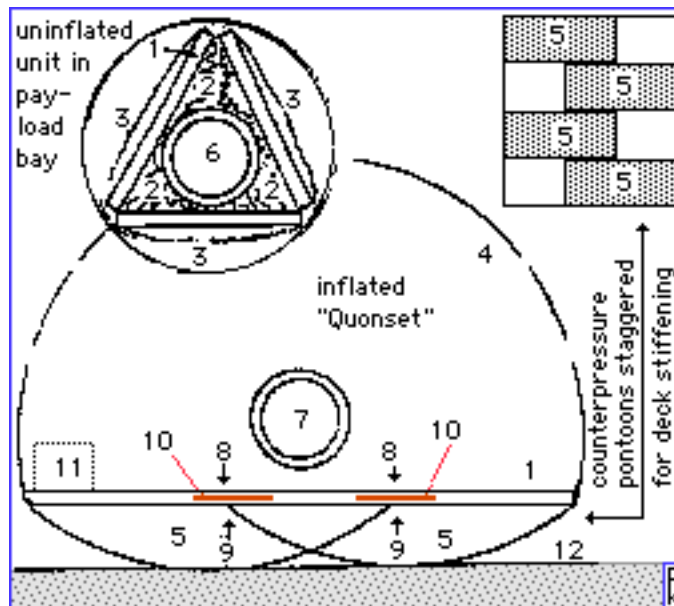

**Figure 6. QUONSET:** [1] Hinged 3-section floor deck. [2] uninflated quonset roof/wall  
 [3] uninflated floor support pontoons [4] inflated quonset roof/wall  
 [5] Inflated floor support pontoons [6] In transit position of docking module  
 [7] Docking tunnel in end wall [8] Downward air pressure on hinges  
 [9] Counterbalance pressure on hinges [10] Contingency stiffening bars  
 [11] Representative pull-up feature [12] Ground contour before shielding

d) Finally, we sketched a hybrid torus design, dubbed the “donut”

In this design, the “donut-hole wall” is replaced with a compact payload-bay sized hexagonal “works” module loaded with pull-out built-in features including top mounted central solar, visual, and EVA access, side-wall vehicle docking port, decking erected from parts brought up in the core module’s “basement”, complete with a peripheral jogging track.

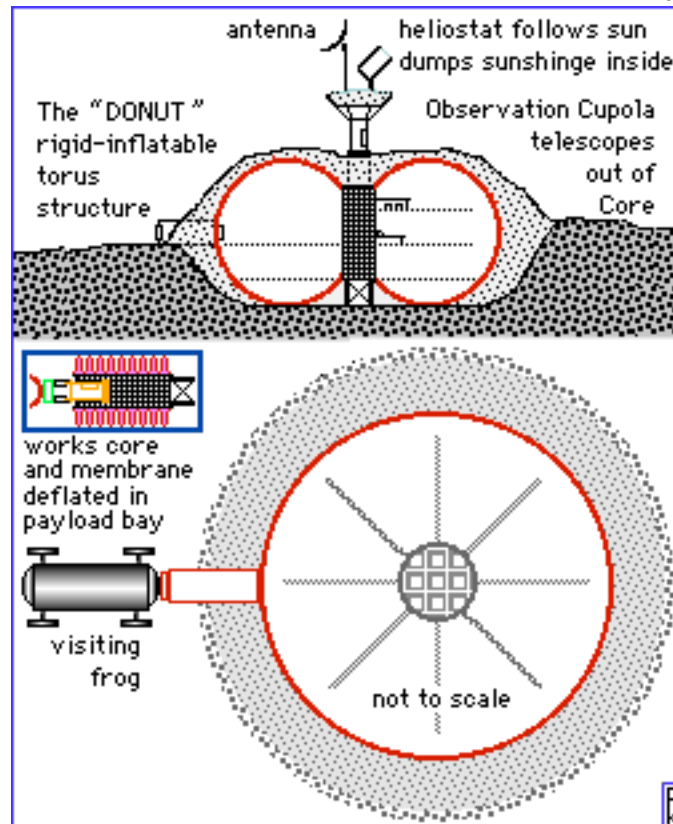

**Figure 7: The Donut:** This 3 floor model at top is an upgrade of the simpler design in the original paper. Shown is the central works-packed core, optional telescoping observation & EVA tower, antenna, heliostat. Docking tube is at left. In this version, a small crater was chosen to make shielding emplacement easier and to allow the frog access to the middle level. Center left: a crude sketch of how the package arrives deflated in a payload bay, and a view of the donut hostel and docked frog from above.

Taking further advantage of this design, the naked inner surface of the outer side wall could easily be pre-painted or pre-printed with a 360° panoramic mural medley of Earthscapes, Spacescapes, and Moonscapes. The sketch above suggests a peripheral walkway to take advantage of such an opportunity. By including two additional coupling ports in the donut’s outer wall at 120° angles we would make possible ‘benzene ring’ clusters of individual donut units for indefinite “organic molecular” expansion potential.

Small conventional instrument-packed modules could be brought up from Earth and coupled at unused ports to allow endless upgrade of the facilities. Of the hybrid inflatable designs investigated, the “donut” seems to lend itself best to all our various design goals. We intend to work with this central core torus design further to bring out its full promise and tackle any unsuspected problems.

e) The “Trilobite”

Once the paper was in the mail to make the publication deadline for the conference proceedings, we thought of yet another promising configuration. In the “trilobite”, the core



works cylinder lays on its side suspended between two larger inflatable cylinders. The area below the core cylinder forms a sheltered bay or ramada for vehicles and routine EVA.

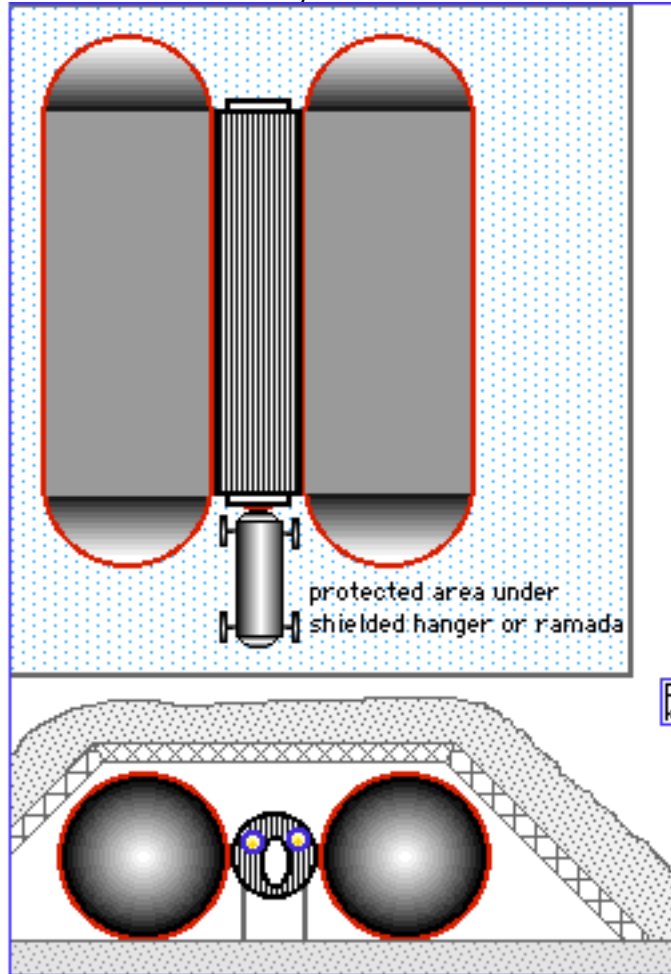

**Figure 8: The Trilobite:** The works core module could be scaled to a 15' wide shuttle payload bay or to a 27' wide faring atop an External Tank, with inflatable cylinders proportionately sized. Here, the trilobite hostel sits under a shielded hanger, making servicing and expansion much easier.

If hybrids are designed as connectable modules for expansion, the vehicle docking port design chosen for standardization should also serve as a module to module connect. This will offer the greatest versatility. Where rigid ribbing cannot be included (all the above designs except the “slinky”) hollow ribbing with a post-inflation fill of rigidizing foam could provide structural support if pressurization was lost. However such a foam must be carefully formulated to drastically minimize noxious outgassing as we are dealing with sealed structures that can't be 'aired out'. The hybrid, while still more limited in size than the pure inflatable (though it comes close in the torus format), offers measurably greater usable floor space than a hard-hulled module designed for transport in the same hold, yet can be full of convenient built-in features. The hybrid, in comparison to the retro-furnished simple inflatable, offers comparable savings over rigid shelter in total imported mass. Thus the hybrid inflatable seems to be the best of both worlds. We have only begun to scratch the surface of this promising world of hybrid inflatable design, and present our first fruits for your stimulation and input.

**(5) Shielding for Prefabricated Hostels:**

Since full tele-deployment would be ideally appropriate for these intermittently staffed outposts, ways of covering the hostel with regolith shielding by robotic or teleoperated means

should be researched. The needed equipment could be small and lightweight with minimal power, as, working slowly prior to the arrival of a crew needing protection, there need be no hurry to finish the job. Perhaps this task could be performed in such a way that the shielding regolith might be gathered as part of the process of grading and compacting a launch pad and a driveway or taxiway to the hostel for visiting frogs to follow. The basic idea is that the first humans to return to the Moon since the departure of Apollo 17 find a cozy place waiting.

### **Hostels Built on the Moon of Native Materials**

The ultimate potential for ample 'Big Dumb Volume' will not be realized until we begun self-manufacturing building materials, modules, and components from native materials, either in-situ, or at a factory site for overland or suborbital delivery to remote sites. Glass glass composites ("glax") or lunar steel are likely to be the building materials soonest available in an upstart settlement. "Lunacrete" would be a competitor if economically recoverable amounts of water-ice are found in lunar polar "permashade" areas. Glass-fiber reinforced cast basalt is an option that seems especially suited for opening remote sites, with modules being manufactured on site by mobile facilities. [2012 Note: Basalt fiber industry is far advanced and appears to have superior qualities.]

### **CONCLUSION**

The hostel concept rests squarely on acceptance of calculated compromises. Such choices run counter-flow to the spread of risk-free expectations in the public culture, something to which any public-funded space program is especially vulnerable. Yet this paradigm promises to both significantly lower the threshold for human return to the Moon, and to significantly accelerate the breakout from any form of first beachhead towards establishment of a truly global presence there. We believe there is more than a bit-role for such "hostels in a hostile land." Meanwhile, many of the ideas explored in the course of developing our topic, would appear to stand on their own. << LRS >>

## **MMM #51 – December 1991**

# **FIRE DEPT**

FIRE DEPARTMENT By Peter Kokh

Fire and Man go back a long time together. A natural phenomenon frequently caused by lightning striking tinder dry forest, brush, and grassland, our ancestral domestication of fire for cooking, heating, artcraft and manufacturing purposes played a role in the rise of civilization hard to exaggerate.

Yet fire out of hand or out of place has been one of the most devastating and frightening perils to life, limb, and property. Our response to this danger has been one of fire codes attempting to both minimize the chance of accidental fires and control the spread of fires once begun. Most every community is served by a paid or volunteer standby Fire Department. In most cases, unwanted fires are quickly controlled and potential damage limited. Smoke and other volatile combustion byproducts of fire are quickly dissipated by flushing to the circulating winds of the vast atmospheric sink surrounding us.

Alas in settlements beyond Earth's atmosphere, the volumes of air available to absorb fire gasses, smoke, and other particulate byproducts will always be most severely limited in comparison to Earthside. Instead of an atmosphere miles deep above our abodes and over vast

thinly populated rural areas, we are likely to have only the few cubic meters per person within pressurized habitat, food growing and work areas and other common places. Even in relatively voluminous megastructures like O'Neill colonies or the Princeton rille-bottom double vault span design, the available "middoors" common volume will still be so minimal by Earth standards that we will have to forgo a strategy of merely controlling fire.

Having nowhere to flush the smoke and fumes, a settlement that has even a small, quickly controlled fire may face at least temporary wholesale abandonment, the incident a catastrophe out of proportion with previous human experience.

Instead, settlers will have no choice but to adopt a zero tolerance for fire. Their first line of defense will not be an automatic fire suppression system, no matter how elaborate. That can only provide a damage control backup and a futile one at that, simply buying time needed for orderly evacuation to standby vehicles or shelters. Rather spacefolk must accept settlement design strictures all but guaranteeing that fires can't start by accident, and that set fires have nowhere to spread.

Because most combustible materials are organics or synthetics rich in carbon and hydrogen, two elements scarce and exotic on the Moon, lunar towns and early space settlements built principally from lunar materials prior to the eventual accessing of cheap volatile sources elsewhere (Phobos and Deimos, asteroids and dead comet hulks) sheer economics will force the choice of largely inorganic and incombustible building materials, furniture, and furnishings. Commonplace wood, paper, organic and synthetic fabrics, and plastics will become exorbitantly expensive choices reserved for the obscene consumption patterns of the ultra-rich. In their place will be various metal alloys, ceramics, concrete, glass, fiberglass, and fiberglass-glass composites (Glax™). Even electrical wire will, for economic reasons, be manufactured on site with inorganic sheathing in place of commonplace plastics. Frontier houses and other structures simply will not burn.

On the Moon, the low gravity ("sixthweight") will greatly reduce the need for cushions, pads, and mattresses that cannot be easily made of these available incombustible inorganic materials. Early Space Colonies will thus have a second incentive to choose lunar standard gravity rather than Earth normal (the first reason being to allow much tighter radiuses, greatly reducing minimum size and structural mass, significantly lowering the threshold for construction).

The two areas of greatest remaining concern will be clothing and drying or composting agricultural biomass. Cotton, since its lunar sourceable oxygen content is much higher than any that of any other fiber choice, renders it easily the least expensive selection. The need to recycle its carbon and hydrogen content upon discard of items made from it, will mandate processing choices for cotton that are organic and thus happily preclude additives with toxic combustion products. The best strategy may be to isolate (even in fabric and clothing shops) concentrations of cotton fabrics and garments from one another in relatively small caches, each guarded by a sprinkler.

Biowaste and biomass management and housekeeping practices, combining strict personnel training with discontinuous storage in small concentrations below critical mass (but again with one-on-one sprinkler vigilance) should all but banish chances of spontaneous combustion and make the spread of set fires impossible. Special attention must be given to grain and powder storage housekeeping and management.

IN SUM: on the early space frontier, fire "control" departments will provide no security. If a fire big enough does break out, the game would be already lost. But what if, despite all precautions, the unthinkable does occur?

Fire shelters connected to the community by air-tight fire doors and relative over-pressurization could be provided, doubling as shelter in event of pressurization loss. However such shelters must be large enough to accommodate the entire community on a short term basis. It may be prudent to design the community with enough fully "isolatable" storage and warehousing space or agricultural space to serve emergency needs. For the only way to recover

from a fire may be to depressurize, then repressurize the affected area. Since a fire may well leave no option but retreat, there should be periodic en masse orderly evacuation drills for the community at large.

As the constraints on building materials ease through cheaper out-sourcing from Deimos and Phobos and/or asteroids and comets, the taboo on using organic and combustible synthetic materials for in-settlement structures, furniture, and furnishings must not be relaxed. In most space locales we will never have the luxury of enough contained ambient atmosphere to allow a return to our current flush it and forget it strategy.

On Mars, in contrast, thanks to the thin carbon dioxide atmosphere and available water and ice reserves, pioneers should be able to produce inexpensive wood and plastics with almost Earth-like ease. Yet here too, until the far off dawning of some new age of "terraforming" that installs a planet-enveloping commonwealth of breathable air, human settlements on Mars will labor under the same threat of sheer disaster from even the most minor of fires as will lunar and space settlements. If the Mars settlements are to allow wood and synthetics, it will be wise they do so with constraints that work to isolate them in discontinuous small pockets.

Economics on Earth has made the abandonment of combustible materials unthinkable. Instead, fire is tolerated and we have "Fire Departments" for "control". Beyond Earth, quite different economic realities will combine with a major exacerbation of the threat posed by fire to make fire truly intolerable, and a strategy of control futile. There won't be any Fire Departments in space frontier towns. MMM

## MMM #52 - FEBRUARY 1992

# XITIES

Xities Pronounced KSIH-tees' not EX-i-tees

Beyond-the-cradle off-Earth settlements ("Xities") will be fundamentally different from the familiar Biosphere- "I"-coddled "cities" that have arisen over the ages to thrive within the given generous maternal biosphere that we have largely taken for granted. Elsewhere within our solar system, each **xity** must provide, nourish, and maintain a biosphere of its own. Together with their mutual physical isolation by surrounding vacuum or unbreathable planetary atmospheres, this central fact has radical ramifications that must immediately transform space frontier **xities** into something cities never were.

In this issue, we investigate a gamut of essential **xity** functions, some familiar but strongly redefined, others new and without precedent, and their demands upon the structure of **xity** bureaucracies, government, and politics. MMM

# Xititech

Xititech by Peter Kokh

While heretofore in human history many departments of cities and towns (health, light and power, streets, traffic, parks, schools etc.) have at least some number of professionals with germane expertise on their payroll, the policy distorting interference of elected politicians, patronage appointees, and job-secure civil servants more often than not has the upper hand. No matter how poorly citizen needs are met, no matter how "unlivable" in relative terms urban

areas may become, people survive. Gaia, the Earth's mothering biosphere, even in the extremes of its climatic crescendos and geological catharses, is relatively friendly even to the shelterless.

Whatever may be the case some distant day out among the stars, anywhere else in our Solar System hinterland that we might eventually establish pockets of civilization, the hostile host environment will not be so forgiving of task-bungling in the name of self-serving interests. Unlike cities, "xities" must be run largely by professionals and technicians if they are to remain "livable" in a sense that is starkly absolute.

To illustrate, consider the department structure likely to be found in any xity government. But lets go backwards in order of significance to our thesis, that is in order of most familiarity to present day terrestrial urban area experience.

### **Xity SCHOOL Systems**

In this country at least, we have an enormous tolerance for mediocrity and outright failure in our schools. After all, our society (as distinguished from the Japanese, for example) is one of atomic individuals whom we deem responsible for their own success or failure. "God helps those who help themselves" etc. We put a low priority on bettering the odds individuals must face. As a result, we are inexorably becoming a second class nation by all per capita (as opposed to gross) standards of measurement. But we will survive.

On the Moon, Mars, out among the asteroids, or in space colonies in free space, clusters of humanity will be so much more challenged by both high thresholds of economic viability and the fragile vulnerability of all but "sink-less" mini-biospheres. They cannot hope to long survive unless they collectively see to it that their xitizenry is appropriately educated on all points on which their continued existence tightly clings. With one on one attention if need be, they must be prepared to accept a much higher level of individual and actively cooperative responsibility for their "commons" [whatever cannot be privately owned like the air, waters, and the environment in general and for which no one therefore seems individually accountable or responsible].

Along with other subjects, each must learn well the facts of mini-biosphere life and the workings of biosphere support systems in enough detail to appropriately affect their individual micro-economic decisions as well as their environment-relevant housekeeping habits both public and domestic. Useful in building appreciation and respect for the xity's potential failure modes would be a universal service system in which each student would at some time do yeoman stints on the farms, in air and water freshening and biowaste composting utilities, in discard collection and recycling chores, and on pressure-integrity maintenance crews. Because their existence will be far more critically dependent on technology than even our own, they cannot possibly be either good enough xitizens or enlightened voters if the rudiments of science and technology are treated as electives as is common practice Earthside. [See "the 4th R", MMM # 34 APR '90., MMMC #4]

Such education will be most effective, of course, if appropriate incentives and conveniences to proper action are built into xity systems. We are too used to passing ordinances without thought to making compliance easy and natural, if not second nature. (If you outlaw spitting on the sidewalk, you should provide handy spittoons, etc.) That will have to change if xities are to succeed against the enormous odds. Living downwind and downstream of themselves, xity-dwellers will be especially prone to choking fatally, en masse, on the business-as-normal by-products of daily life.

Baring censorship, a poor solution, space frontier xitizens, settler and native-born alike, will likely be reminded or exposed to the saturation point with television and videos depicting everyday life in Earth cities under conditions so relatively forgiving as to permit general inattention, dismissal, or even contempt for the commons. In frontier xities, schools will have to sweat up an especially steep hill as a result.

Future Lunans, Martians, Belters, or Space Colonists may not be able to order the latest fashion design, kitchen convenience, or electronic gizmo from the Sears catalog, or go to their neighborhood K-Mart or area mall lined with specialty shops featuring everything under the

sun. They may not have supermarkets with an infinite selection of prepared convenience foods, toy outlets featuring plastic incarnations of the latest cartoon heroes, bad guys, and monsters. Nor will the current fare in chic throwaway fascinations Earthside be available.

Instead young and old alike will have to be prepared for the crude, make-do substitutions of the frontier. This will strongly motivate settler artists, craftsfolk, and entrepreneurs to make and produce improved and refined goods that from production to ultimate disposal respect their fragile mini-bio-spheres and the recycling systems that help make them work. At the same time such new wares will help build a do-or-die long-term trade surplus (see below) by ever working to further defray “upports” from Earth and expand total exports.

One can imagine the curator of the local museum selecting for the “Reminiscences of Earth” hall, principally ethnic folk and frontier items that, even if not appropriate for space frontier situations, demonstrate encouragingly the best in human resourcefulness under challenge. By contrast, the latest carefree titillations for individual convenience will be well enough represented by film and video.

### **Xity HEALTH Department**

Space frontier Health Departments will be charged with more aggressive attention to public and domestic house-keeping conditions that could promote the spread of any pests that slip through space transportation safeguards (food cargoes pressurized in 150° F nitrogen, or exposed to vacuum; settler screening and clothing trade-ins etc.) But here again, education will be primary.

Public **health dollars** in the U.S. grease the squeaky wheel. Thus much more attention is given to keeping the no-longer productive person alive, than in ensuring that the young do not grow up so unhealthy as to later burden the system. Space frontier settlements will be hard pressed to survive unless a much higher fraction of their populations are productive than seems acceptable on Earth. So priorities will be turned around with emphasis on expectant mothers, infants, children, and seniors with good years left in them. In respect to the latter, the emphasis must be on improving quality of life, not on extending it for extension’s sake. Bear in mind that in very isolated space frontier settlements, xities may be really xity-states, concerning themselves locally with cares here left to the state or jockeying candidates for national office.

**Development of all-new Sports** will be a new concern for xities, or for associations of xities sharing similar gravity/inertial situations. For most of the traditional sports we now enjoy will transplant poorly. [Jai Alai is one possible exception]. But Earth-return physical and physiological rehabilitation programs might well be left to free enterprise.

### **Department of SOCIAL Services**

For reasons already cited, when it comes to Social Welfare, the xity’s “first line of defense” must be before-the-fact prevention rather than after-the-fact assistance or outright neglect (not only in third world cities, but of our own urban address-less). The universal if never stated presumption on Earth that, if need be, people can survive fending and foraging for themselves, will be an all too obviously unthinkable one within the confines of mini-biospheres quarantined from one another not only by miles, but by hard vacuum and radiation or unbreathable planetary atmospheres. Again the stress will be on education and training to be flexibly productive.

### **Department of ECONOMIC Diversity and Trade**

Nowadays, increasingly strapped American cities are taking a much less laissez-faire attitude towards their industrial and commercial bases. For xities, this will not only be a way of countering economic decline as they age, or to promote new and reformed prosperity, but a matter of sheer survival. In point of fact for Earthbound cities, as the nations they drive, a negative trade balance with the outside can be sustained for a surprisingly long time – though tolerated slippage in the standard of living, and/or reversion to “simpler times” – read more direct reliance on the support capacity of “Mother Earth”. And through income redistribution bandages, areas that lag badly can be propped up by those enjoying better times.



Neither recourse is likely beyond Earth-orbit. Xities will either ever re-justify themselves economically, or they will end up being abandoned, sooner rather than later. Xities, and associations of xities sharing the same planetary or space setting, must through publicly supported means, endeavor to ensure that local entrepreneurs find ever new ways to turn local resources (or other raw materials more cheaply accessed than shipment up the expensively deep gravity well from Earth) into new products for domestic consumption to reduce the need or pressure to upport from Earth, or into products for sale to Earth, Earth-orbit facilities, and to other off-planet settlements, in sufficient volume to fully pay for whatever upports and other imports that the xity cannot (or prefers not) to do without – and to do so with reserve-building surplus.

A **xity university**, however modest by today's standards, would be a logical agency to promote industrial and commercial diversification, even helpful new arts and crafts. The university could do ground-breaking materials use research and then assist entrepreneurs in development of marketable products for some limited share in the royalties.

To support this diversification, xities on planetary surfaces (Moon, Mars, larger asteroids, etc.) will support continuing development of the potential economic geography of their hinterland surroundings. This will mean establishing satellite outposts (some of them perhaps to become rivaling xities in their own right) in order to add to the mix of minerals and raw materials upon which economic diversity rests.

Space Colonies, each more like Singapore than analogs of giant Japan (a comparison frequently made), may bind together in leagues to better exploit asteroidal and cometary resources. The goal will be to lessen the restriction of their economies to industries supportable by a diet of lunar raw materials alone. This need to establish and continue a favorable trade balance will drive an initial handful of surface and space xities ultimately to develop much of the Solar System, whether Earth itself remains interested or not.

An **Office of Strategic Materials and Import Protocols** could employ some blend of taxation and credits to ensure that strategic materials in short supply (e.g. on the Moon: hydrogen, carbon, nitrogen, and metals other than iron, aluminum, titanium, and magnesium) were not diverted into spurious luxury uses or tied up in non-durable products without efficient fast-turnaround recycling systems that work.

It will be also be in the xity's interest to maximize **interxity trade** so that together the xities are not just financially self-supporting but also industrially and agriculturally self-sufficient if ever Earth cuts off trade, whether as a result of world conflict, major depression, isolationist politics, or the spreading of hostile fundamentalisms in the various world faiths. Such an ability to collectively survive the cutting of the umbilical cord to the womb-world must be the cornerstone of every xity-state's "foreign" policy.

#### **Department of the Xity BIOSPHERE**

The differences between mega-biosphere-contained cities and mini-biosphere-containing xities, as described above, while significant, may seem matters of stress, emphasis, and priority. We won't argue the point. But that's as far as one can stretch the kinship. No city on Earth must build a containment system, mega-structural or modular, for its atmosphere. Nor need any city on Earth concern itself with maintaining its own climate or the routine sequencing of its seasons (beyond the provision of air-conditioned skywalks and other structure-connecting passages, as popular perks).

No city on Earth must be dependent upon a closed loop water supply, drainage, and recycling system totally within its own limits (even island city-states like Singapore have the surrounding sea). In contrast, no xity will ever be founded on a coast or lakeshore or river or over a subsurface aquifer – at least not until the "rejuvenaissance" [a coinage decidedly preferable in its connotations and the pathways it suggests to "terraforming"] of Mars is fairly well along.

A **Corps of Pressurization Engineers** will be charged with containment integrity and maintenance of the atmospheric pressure of the settlement within the desired limits. Ever

vigilant for leaks and structural weaknesses, they will preventively repair microcracks, monitor the performance of sealants, and relieve structural stresses safely. Automatic detection devices and frequent human inspections will be crosschecks in preventing failures of regular airlocks, liquid airlocks [MMM # 17 JUL '88], and matchports [MMM # 15 MAY '87 – both included in MMMC2]. The corps' job will be different in megastructures such as O'Neill colonies, Bova-Rawlings' Main Plaza [Welcome to Moonbase, Ben Bova, Ballantine '88] or the double vaulted rille-bottom villages of the Prinzton design (LRS '89) from that of those charged with this most critical of all xity responsibilities in modularly constructed settlements with physical growth potential (banded and modular torus space colonies, the double helix oases [MMM # 11 FEB '88], and any of the more common Moon and Mars base proposals. Depending on the settlement's overall architectural plan, separated or separable fall-back safe havens need to be provided and maintained.

The work of the corps presupposed, the **Office of Atmosphere Quality** will be charged with maintaining air freshness and the proper mix of gasses: oxygen, nitrogen or other buffer gasses, and carbon dioxide.

The settlement may have some sort of baffling separating the agricultural, residential, and industrial areas. If so, the fans and ducts which provide for flow of fresh and stale air across these baffles without back flow, need to be maintained to preserve air quality.

The **Hydrosphere Office** will maintain the xity's water reserves and their cycling starting with the dehumidifiers that condense excess humidity from plant transpiration to provide fresh clean drinking water. The Office may maintain a tritreme drainage system [MMM # 40 NOV '90 "Cloacal vs. Tritreme Plumbing"] that keeps separate, for ease of treatment, sanitary waste water, gray water from washing and bathing, agricultural runoff, etc.

On the Moon, reserve water supplies may be shunted in a cycle through dayspan electrolyzers and nightspan fuel cells to produce power to complement off-line solar generators. Reserve water can even be cycled through closed-loop high head rille-side or crater-side hydroelectric stations, again to boost nightspan power [see MMM # 31 DEC '90 pp 4-5; also in MMMC #4].

But reserves can also be used to improve air quality by running them through fountains and waterfalls to mist and cleanse the air, and to add further to the quality of xity life in the form of canals and lagoons for boating, pools for swim-ming, and even trout steams for fishing.

Whereas some cities take upon themselves the task of providing and maintaining green markets by which produce from rural farms can be sold directly to city dwellers, in xities beyond Earth, under the Biosphere Dept., there will be a **Sub Department of Agriculture**, with far more responsibility than even national agriculture departments here on Earth. For in xities, the antithesis of farm and city will be resolved. The xity will contain major agricultural areas within its biosphere, not only for logistic and economic sense, but because the farm areas will play the critical role in the recycling of stale air into fresh. The composting of solid organic wastes will be its duty.

A system of parks, pathways, picnic strips and memorial gardens might well be integrated into portions of the agricultural areas adjacent to residential, industrial, and commercial zones. Since the emphasis will be on plants that serve an economic need, even landscaping and "streetside" plantings will be selected to fulfill a dual purpose. Thus the whole eco-system makeup of the xity biosphere's general flora will be under this sub-department.

Agriculture will also bear upon the selection of livestock (if meat-eating survives as an accepted lifestyle) and the xity's complement of urban "wildlife" (some species needed to make the ecosystem work, and maybe some others more for public enjoyment). This sub-department would also license allowable pets and enforce their reproductive control.

As serious a job as is running a major city in today's world, the burden of responsibility on the Xity Parents out on the space frontier will be much heavier. The very continued existence of the xitzenry will lie in their hands. There will be far less room for the discretionary nonsenses of political decisions, far more entrusted to the care of responsible technicians. This

will affect not only the structure and divisions of city bureaucracy but the roles of elected officials and how they see them.

These life-in-the-balance responsibilities may even require final abandonment of the dictatorship of the majority [our present system, wherein each faction attempts to gain a mere 50% plus advantage, in order to thrust some premature solution serving vested interests down the throat of any other equally noncooperative faction] for governance by informed consensus. Government by co- "promise" not by compromise.

The extraterrestrial city will be a precedent shattering institution. And just maybe, Earth cities will pick up a few helpful pointers in the watching. MMM

## On the Space Frontier, can there be any **FIRESIDE**

Fireside around which to gather?

By Peter Kokh

Since time immemorial, ever since the taming of fire, humans have sought warmth, comfort, and company huddled around campfires and hearths. Even today, when a dwindling number of modern homes boast the luxury of a fireplace, nestling around the fire is something we all enjoy – when it is cold or damp, when we are out camping, on a clambake or a picnic in the park, or just out on the patio or in the back yard for a barbecue or marshmallow roast. And can any of us forget the bonfires after a high school homecoming football games?

While nowadays, such pleasures are scarcely everyday experiences, however infrequently enjoyed, the magic of the fire is so much a universally positive experience that it is still possible to ask: "can it be humanity if there is no campfire?"

In "FIRE DEPT." MMM # 51 DEC '91, we pointed out the very intolerability of open fire, controlled or not, in the very limited atmospherules of mini biospheres. But that is not the last gloomy word, for it only applies to fires in which the combustion products are smoke and toxic gasses.

In MMM # 40 NOV '90 "METHANE" we discussed the possibility of controlled burning of compost-pile derived methane to produce water vapor along with CO<sub>2</sub> for plant nourishment. Such combustion will need to be confined to nitrogen-free chambers so as to avoid unwanted nitrogen oxide byproducts. Could such a methane-oxygen fed flame in a glass-faced chamber serve as a fireplace substitute? Why not?

It should also be possible to devise a tightly confined hearth "substitute" that slowly fed together pure hydrogen and oxygen. If again the burning is confined to a nitrogen-free chamber, the only combustion product would be steam – pure water, which can then be used for drinking or other purposes. In effect, we are talking about a modified fuel cell, in which the  $2H_2 + O_2 = 2H_2O$  reaction is run somewhat faster, not so fast as to be explosive, but fast enough to sustain a flame, perhaps with a harmless enough additive (if one can be found!) to colorize the normally invisible H+O fire.

I'd be surprised if either such device now exists, with little market for them – down here. But out on the frontier, a flame-in-a-jar device might create enough symbolic warmth and cheer to become commonplace in settler homes on the Moon or Mars or elsewhere, in gathering spot lounges, even on long trips aboard spacecraft or surface roving coaches.

Why not tinker up such devices now? The methane version could not be used in draft-tight close quarters but a hydrogen hearth might sell to apartment dwellers, especially singles wanting the latest in trendy mood-setting gizmos. Just knowing that we could take such "fire

chamber” with us, could make the prospects of life on the space frontier just a little less daunting, just a little more reassuring. MMM

## MMM #53 – MARCH 1992

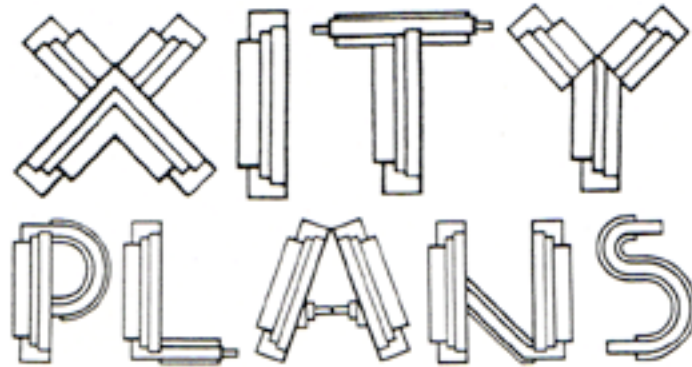

XITY PLANS By Peter Kokh

### INTRODUCTORY DISCUSSION

As a rule proved by its exceedingly rare exceptions, Earthbound cities are founded and grow haphazardly, a mosaic of micro-economic decisions and ad hoc solutions. Sometimes there are scattered allusions to a priori blueprints showing up in road systems and other infrastructures. But far more often, and especially the case with older cities, there is no more than some brave flirtation with after-the-fact master planning that attempts to rescue order from chaos and impose some facade of logic. All of this development occurs within the context of the transcendent terrestrial biosphere, without which such “wild” growth and development patterns could not be suffered.

#### **Xity as Biosphere**

Beyond Earth, the tables are turned, and biospheres will exist solely within the context of discrete xities. That makes xity planning serious a priori stuff with more, or less, room for subsequent adjustments. First, considering the xity’s design as a biosphere provider and maintainer, the challenge is far greater than almost all space development advocates and visionaries imagine. Most artistic visualizations of lunar or Martian surface settlements that one sees (and they determine the expectations of those who cannot visualize on their own) show a maze of habitat and function modules with token inclusion of agricultural areas. That won’t do. Consider a trial definition of a xity:

**A XITY is a human outpost outside Biosphere “I” (Earth) that (1) provides not just permanent serial occupancy, but permanent lifetime residency for individuals and families, and their educational, cultural, and other needs; AND (2) provides as complete a bioregenerative life support system as is practical.**

As ongoing experience with the Biosphere II project, in its fourth month of closure at this writing, is demonstrating so well, even a much higher ratio of plant mass to human mass than most space planners had naively thought they could get by with, is proving inadequate. CO<sub>2</sub> scrubbers have had to be installed.

**Xity master plans can not simply place plant life and food growing areas in a human context. They must sprinkle humans sparingly, as they are the more dependent partner in a fragile symbiosis, in a setting that is principally one of vegetation and crops.**

In other words the xity must include its own rural hinterland. Without this, there is no hope of providing any real sort of biological flywheel, leaving settler survival to depend

proportionately on machines, however sophisticated, with their much higher susceptibility to “failure modes”.

### **Xity as “individual-friendly”**

There is another challenge here. As individuals, we give significance to our lives as we make over into something friendly and personal what greets us as strange and impersonal.

**To the extent Xities need more careful and more closely followed master planning than cities, can they provide shelter without suffocating individual need to creatively design it—says-me personal space?**

It is not enough to provide for interior decorating opportunities. It is equally vital that the public appearance of private spaces be left to resident discretion.

Indeed, it is often the very unplanned character of Earth’s cities, the colorful patchwork patterns of individually determined “improvements” through the years and generations that, however it sometimes threatens over all functioning, can make them such delightful places to live in. Master plans which do not leave maximum play for individual discretion, as many a well-intentioned urban renewal project has attested, can choke the very spirit out of a city and its individual residents, even while attempting to unchoke urban traffic and provide an overall alluringly deceptive tyrannical beauty.

**BASIC OPTIONS** [While as an unapologetic “planetary chauvinist”, the writer’s chief interest lies with settlements on planetary surfaces, the general points made here must be applied as religiously by xity-architects of space colony settlements as well. For a fresh new approach to the latter, see MMM # 12 FEB ‘88 pp.3-7 “SPACE OASES: Part 4. Static Design Traps, and Part 5.A Biodynamic Masterplan,” For the complete 12 page series on Space Oases see MMM Classics #2.]

### **I. “Thesis”: UNITARY Megastructure**

Eye-catching visionary depictions of free space and planetary surface settlements involve great megastructures that must usually be completed in toto before the first settler can **move** in. They must sooner, rather than later, reach the design limit for their population with ensuing cultural stagnation and ecosystem aging being the common prospect.

**PLUSES:** ✓ megastructures offer less surface per volume (even per square foot) with correspondingly fewer joints and couplings able to spring pressure leaks. ✓ As conceived, they offer greater space for a life-supporting ecosystem – at least until the pressures of growing population in a fixed volume results in the temptation to “develop” “natural” areas. ✓ The large open volumes of such megastructures also offer easier air circulation pattern promising simpler maintenance and lower atmospheric failure modes.

**MINUSES** are ✓ the very high occupancy threshold – a lot of construction before the first citizen can move in; and ✓ the lack of easy congruous growth potential. ✓ The temptation to erode an initially good biomass-population ratio by encroachment has already been mentioned.

Megastructures share structural failure risks rather than distribute them locally. Further, such structures also have the greatest need for extra counter-pressure structural reinforcement. A plus and minus both, Lunar and Martian mega-structure xities will need extra shielding to gravitationally counter the structure-straining air pressures within, increasing the desirability of less than Earth-normal atmospheric pressure, already attractive as a nitrogen import cost cutter.

Familiar examples of such Megastructure Xities in free space include [NOT TO SCALE] the [1] Stanford Torus, [2] the Bernal Sphere, and [3] the O’Neill Sunflower cylinder.

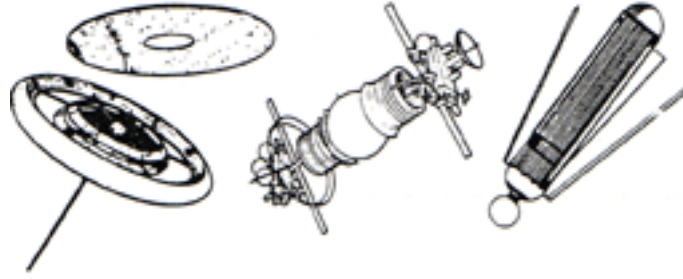

Surface examples of megastructure approach are Bova (Rawlings illustrated) “Main Plaza” and Domed Xity.

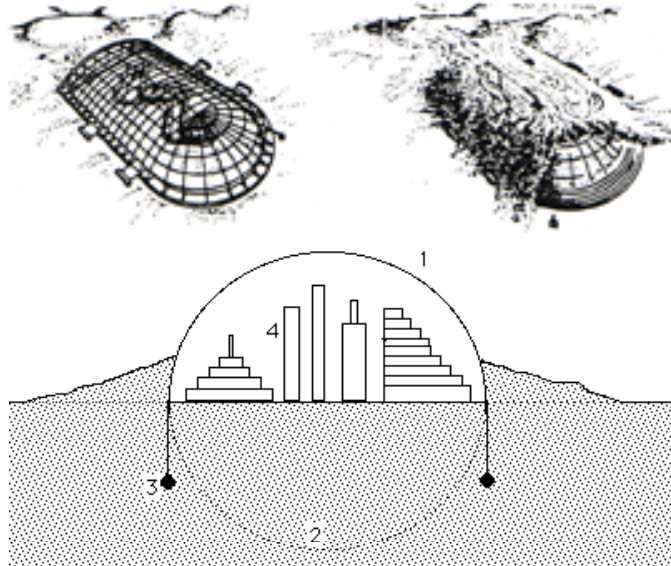

**THE DOME** – favorite of Sci-Fi pulp covers. A glass? hemisphere or geodesic dome [1] (which, unlike a full sphere or cylindroid [2], must be anchored [3] to prevent it from being blown off the surface by internal air pressure) allows traditional Earth-style architecture (e.g. skyscrapers [4]) to be erected within.

While glass can protect against ultraviolet, unless 2–4 meters thick, it could not protect against cosmic radiation or solar flares. If the glass is thinner than that, the exterior walls and roofs of the enclosed buildings would have to be thick enough to serve as shielding, and inhabitants would have to severely limit their excursions “outdoors” within the dome (i.e. middoors). A domed xity may be a bit less far-fetched on Mars than on the Moon especially if the native CO<sub>2</sub> atmosphere can be thickened appreciably.

## II. “Antithesis”: MODULAR Versatility

Most recent design studies for space frontier settlements are much more modest, driven by economic reality to find the very lowest threshold for occupancy. Out are the great unitary structures. In are modest modular concepts that will allow growth at any pace and in any direction.

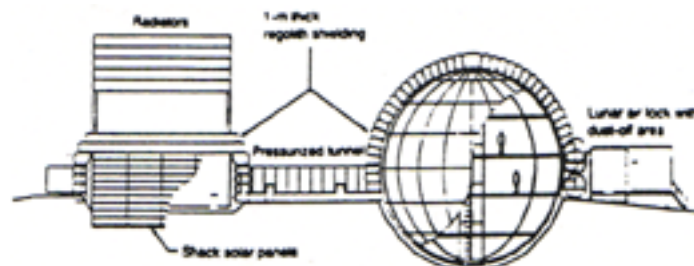



A CURRENT NASA MOONBASE DESIGN incorporates a Space Station type module [left] transportable in the shuttle payload bay and, for elbow room, a multi-story inflatable sphere [right].



TWO MODULAR DESIGN STUDIES above and below done by University of Wisconsin-Milwaukee Architecture Dept. students working under a multi-year NASA grant:

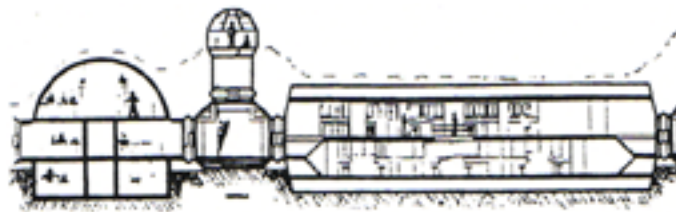

**PLUSES for modular designs include**

- ✓ most flexible growth potential;
- ✓ minimum need for structural counter-pressure reinforcement;
- ✓ tops in structural ability to contain normal 1 ATM;
- ✓ distributive structural failure risk.

**MINUSES for modular designs include**

- ✓ the highest surface to volume and surface to square foot ratios;
- ✓ very high count of leak-prone joints and connectors;
- ✓ highest failure mode for atmospheric circulation maintenance;
- ✓ very high susceptibility to biosphere inadequacy and overrun.

**Improving Modularity: Clearspan Shielding**

While modular plans offer great versatility for future expansion, the actual addition and/or changeout of modules can be made less cumbersome if each is not individually shielded either with “snow-blown” regolith or with cleaner-to-handle regolith-packed sacks. Instead a free-standing and open-ended “clearspan” can be built, with adequate shielding placed above to create a sheltered “lee space” below in which to park, and connect sundry module, nodes, and passageways. Such a site shed not only offers harbor from UV, flare, cosmic ray, and micro-meteorites for the emplaced modules of the base or settlement, but for those doing the work of emplacement and hookup. ‘Dozer-habitat accidents such as might occur in providing individual shielding for each new module are avoided. The EVA of construction, once the clear shield is up, proceeds in a “soft space” environment in which cumbersome rad-hardened spacesuits are not needed. At the same time, permanent sheltered “ramada” space is provided for routine near-module housekeeping activities:

- ✓ inspection for leaks and leak repair;
- ✓ changeout of volatile resupply tanks;
- ✓ tending experiment or processing packages that require vacuum but not necessarily radiation, etc. [see MMM # 37 JUL ‘90 “RAMADAS” and “FLARESHEDS”. MMM Classics #4].

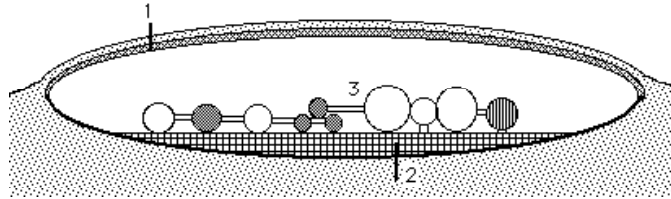

CLEARSPAN SHIELDING with modular settlement in the “lee space” below:

- 1 space frame to support shielding overburden;
- 2 framework over uneven terrain;
- 3 pressure hulls of modular settlement. This approach duplicates the protection offered by unpressurized lunar lava tubes in areas of the Moon where they are not to be found.

### III. “Synthesis”: CELLULAR Rhythm

While clearspan shielding, a simple concession to the megastructure approach, offers a quantum improvement in deployability and operation of a modular base or settlement, it still does not address the serious drawbacks of modularity mentioned above. By taking a strategic look ahead to prepare for large-scale growth of the settlement into a real xity rather than piecemeal expansion of an outpost into a base complex, we can come up with various sorts of “segmented” or “polymeric” expansion, in which each “monomer” or “xiticell” repeats the basic organic functions of the xity.

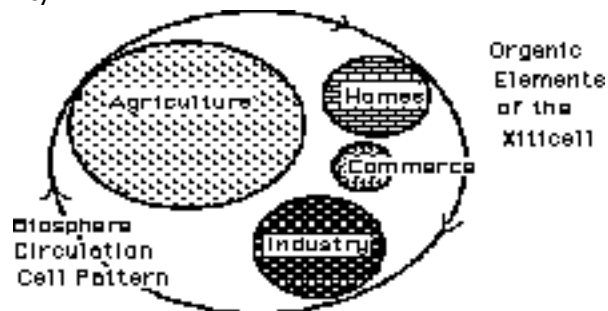

### BASIC ELEMENTS OF THE XITY FOUND IN XITICELLS

By repeating these at large elements in small ‘village’ clusters, the Xity can start small, grow by rhythmic repetition (with adjustments in architecture, relative sizing, recycling, thermal management, and power systems as dictated by experience) to any size. A collapse of the ecosystem in one xiticell could be isolated, leaving the rest of the xity intact. Such segmentation allows evolution of systems and does not commit the Xity at large to continue systems and infrastructures and layout patterns that turn out to be unsatisfactory.

With such a xity planning philosophy at the helm, we can combine the very distinct advantages of megastructural and modular approaches, by using large scale modules to create the first and successive xiticells. For example, a residential neighborhood unit (in size and population reminiscent of one or more city blocks in American cities) could be contained in one larger scale cylindrical module as opposed to modules for each habitat plus pressurized passage and traffic connectors.

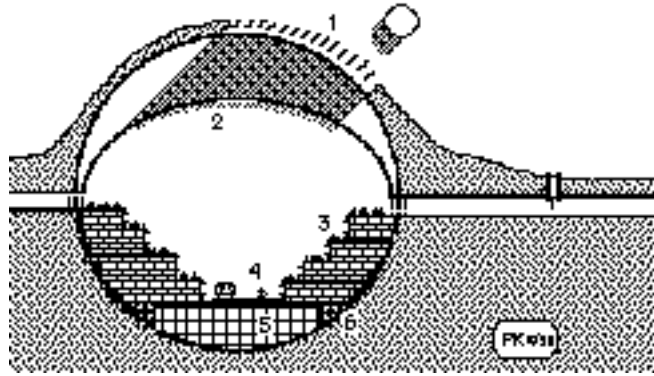

### THE RESIDENTIAL STREET ('HOOD) AS THE MODULE

Cross-Section of cylindrical module 40m x 700 m: {1} shield louvers that let in the sunlight; [2] a suspended sky-blue diffusing "sky" - air pressure would be the same on both sides; [3] terraced residential housing with rooftop gardens; [4] the thoroughfare running the length of the (neighbor)'hood; [5] light industry and shopping, possibly offices and schools; [6] conduits for utilities.

This scheme enables a large variety of conventional architecture for the enclosed buildings and mediates "indoors" living and work space and "outdoors" vacuum with landscapable pressurized "middoors" commons for more Earth-like living. At the same time it greatly minimized the total hull interface with the vacuum. Several such large "'hood" modules along with industrial park-sized modules and farming modules are one way to form a Xiticell or basic village unit with functional biosphere, establishing a rhythm for future growth.

**PLUSES for the Xiticell approach to a synthesis between megastructure and modularity include:**

- ✓ Intermediate threshold to occupancy;
- ✓ Lessened air/water leakage vulnerability;
- ✓ Lessened failure modes for air circulation;
- ✓ Partially distributed structural failure risk;
- ✓ Moderate structural counter-pressure and impact reinforcement needs and need for reduced ATM levels;
- ✓ Intermediate flexibility of growth potential;
- ✓ Ability to switch to better utility and infrastructure systems in new cells;
- ✓ Reduced biomass encroachment threat;
- ✓ Room for adjusting biomass ratios in new cells;
- ✓ Best bet for biomass maintenance;
- ✓ Possible phase-in of xity-center and village-suburb "metro" structure;
- ✓ Logical extend as you grow internal cellular transit systems;
- ✓ 3-shift friendly .

The 1989 LRS "Prinzton" settlement design, with its three villages, embodies some of these elements but involves more megastructure than the xiticell plan outlined above. The dual (or triple) helix approach to free space oasis construction outlined in MMM # 12 FEB '88 "Biodynamic Masterplan" is a better illustration.[MMM Classics #2]

Where do we go from here (a complex of individually shielded modules)? Adopting the Clearspan for subsequent early outpost expansion would be a start, switching to larger xiticell-organic modules next.

MMM

# XITIES

Series Cont.

“XITIES” Pronounced KSIH-tees’ not EX-i-tees  
[Human communities beyond Earth’s cradling biosphere]

## XITYPLANS

XITYPLANS By Peter Kokh

**Part II:** Last month, because of the shortened 12 page version of MMM # 53, we had to cut our discussion short, with much of what we had wanted to say left unsaid. Here’s the balance.

If the trouble with megastructures is the very high construction threshold before first occupancy can begin (the biosphere retaining shell has to be built all at one) the trouble with the micro-modular concepts now in vogue is, on the one hand, the very high surface to volume and joint count to volume ratios (multiplying, without real compensation in any cost to benefit ratio, unacceptable leakage rates and the chances for decompressive failure) and, on the other hand, a convoluted layout with many constrictive points, all of which must work against free atmospheric circulation within the settlement’s mini-biosphere. The cramped spaces of the micro-modular settlement are apt to leave much too little space for vegetation (which should play the host to humans, not the other way around) and all of that, likely in food-production modules not adequately integrated with the whole complex.

=====

**In any biosphere, vegetation should play the host to humans, not the other way around**

=====

Our suggestion has been to move to larger “block” sized modules (intermediate between building size units and settlement-sized megastructures) all of which would have an important place for vegetation, each module contributing not just to the settlement economy but to its biospheric self-maintenance. To do this, we need to move quickly beyond shuttle payload bay-sized sardine cans [limit is 15 x 60 ft], shuttle external tank or Energiya sized modules [27.5 x 97 ft], beyond simple inflatable spheres and cylinders, to modular prefab construction with building elements manufactured on site on the Moon, or Mars, or asteroid as the case may be. A facility that can spin integral cylinders of glass/glass composites [glax] of as large a diameter as can be transported locally (assuming the factory does not itself move) should be a high priority.

Given such a capacity, the settlement could grow one large module at a time. Such modules should be used not only for residential neighborhoods, nor only for agricultural areas, but also for well-greened commercial and industrial space.

Even the connectors should be relatively generous in cross-section, providing, religiously, space for vegetation as well as traffic. Such connecting trafficways should have at least the girth of the ET e.g. 27.5 ft, which might allow them to be constructed of salvaged cargo holds. To illustrate:

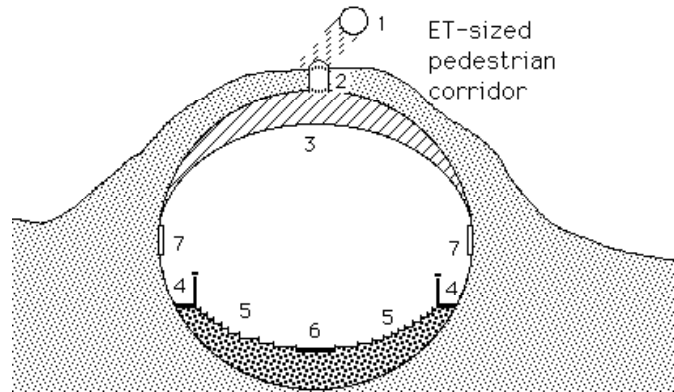

KEY: (1) Sun, (2) fiber optic bundle sunpipe, (3) sky-blue sunlight diffuser (same air pressure either side), (4) pedestrian walkways, (5) terraced plant beds, (6) gardener's path, (7) art and poster gallery.

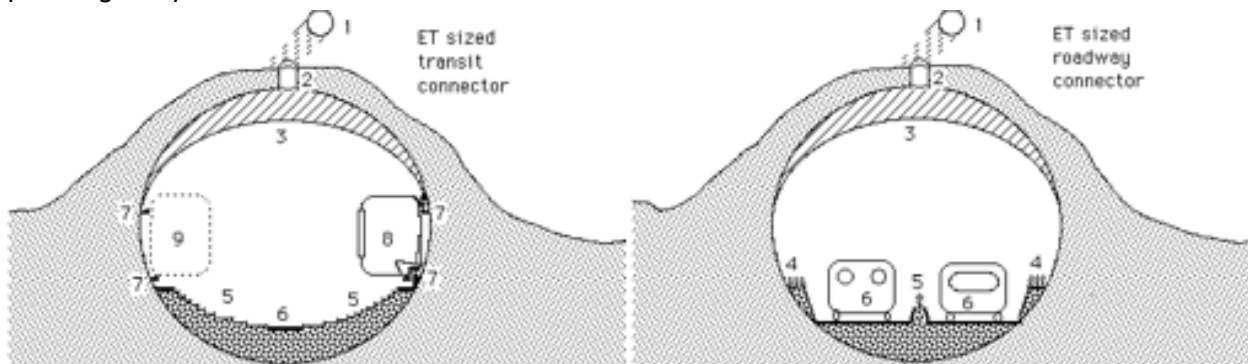

KEY LEFT: (1, 2, 3, 5, 6) as above. (7) wall-mount rail suspension system, (8, 9) bench seat transit car.

KEY RIGHT: (1, 2, 3) as above. (4) plant bed and hanging garden, (5) planter-topped divider, (6) vehicles. In all of these connector examples, there is a place for vegetation, and the more place the better. It is more than a matter of morale, the comfort of mothering greenery against the stark sterile barrenness beyond the settlement airlocks. It is a matter of always paying heed to the overriding requirement to maintain a healthy and integrally functioning biosphere as a host to all other activities within the settlement hull complex.

### Polymerization – Growth Patterns

Given properly functional-sized modules, how should the settlement, any settlement, grow? Should growth be helter skelter, unplanned? Or are there good reasons to suggest some patterns of add-on connectivity over others? As with terrestrial cities, the lay of the land will supply some sort of template, but perhaps to a lesser extent. Unlike Earth cities, cities on the Moon will not be nestling along river banks or seashores. On Mars, the siting considerations become more tricky and the potential drainage channeling of current dry land will have a say on the directions of settlement expansion. In free space, modular settlements will follow their own internal logic, one in which the principal consideration is the chosen radius for centrifugally provided artificial gravity.

But back to surface settlements. Let's consider as thesis the linear model of expansion. We simply add modules end to end in one long line. This has the advantage of making a spinal transit system simple and functional. The disadvantages are first, the overall damper on physical networking as the mean distance between any two sites (and citizens) grows linearly with the population. Second, the long and narrow overall complex makes a circulating atmosphere quite a plumbing problem.

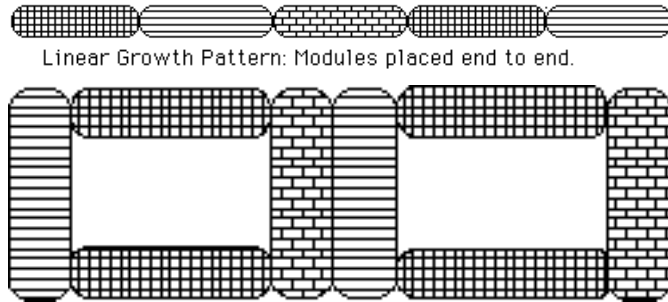

**Above right:** One of many possible “crystalline” growth patterns for the modular settlement. The antithesis, then, is the crystal lattice, where the average distance between sites and “xitzens” grows only as the square root of the population, i.e. as the radius of the cluster of modules. The atmosphere can circulate and the biosphere can function more integrally. On the other hand, any sort of mass transit or people-mover network becomes more complex. Further, instead of two points of growth, the crystal has many points for growth. This can be a plus. It can also be a political nightmare.

The synthesis may be a pattern taken from nature, one in which the assets of linear expansion and self-clustering are elegantly co- “promised”, i.e. the spiral pattern of the snail, the nautilus, and other creatures. Here a single spinal transit nerve just keeps growing from one end, while radial connectors keep everything compactly close at hand.

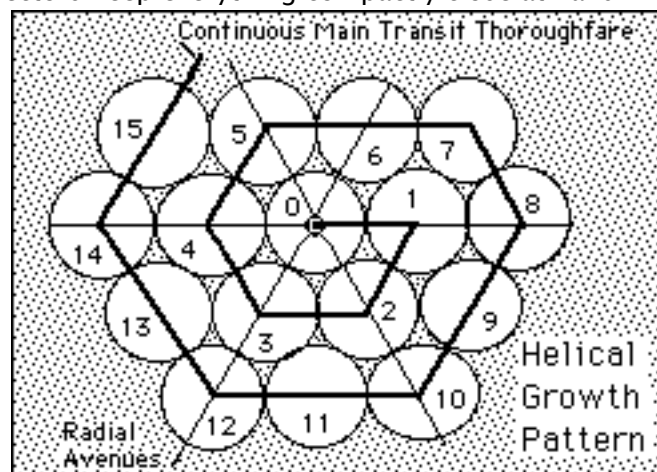

KEY: Order of construction 1-15 etc. with 0 being reserved for a metro downtown that can be added whenever needed. C would be the central plaza and eventual origin of the transit corridor. There is no limit to potential expansion

Such considerations may be foreign to cities on Earth. Off planet, all human settlements will be behind the eight-ball and will need every advantage for efficient functioning that they can draw upon.

Used to best advantage, the helical pattern will unite not individual modules, even modules of size, but “xiticells” or clusters of modules in which all the basic elements of a functioning Xity-with-biosphere are represented and repeated. To be sure, as sketched below, this concept seems a little utopian, but elements of it are sure to recommend themselves to future Xity planners and architects on the space frontier.



Our expectation of what a Lunar Outpost or Settlement might look like from the vantage point of a surface overlook has become one of a monotonously drab pattern of regolith mounds, the telltale sign of pressurized living space below. This “molehill-scape” is little relieved by its punctuation with occasional observation cupolas, exposed air locks, solar arrays and heliostats, peripheral tanks of volatiles, and other external warehousing. “Once you’ve seen one moonburg you will have seen them all.” Not necessarily so! Eventually Lunan architects will rise to the challenge. See below.

# XITIES

**Series Cont. Pronounced KSIH-tees’ not EX-i-tees**

[Human communities beyond Earth’s cradling biosphere]

By Peter Kokh

This month we look at how future Lunan Architects will be challenged by the conditions of their environment, with full attention to structural integrity under pressurization stress and to shielding from cosmic rays and solar flares.

To illustrate the possibilities, three articles follow: SKYSCRAPERS?, MOON ROOFS, and SHANTYTOWN.



SKYSCRAPERS ON THE MOON?: BEYOND MOLE HILL CITY

By Peter Kokh

Perhaps you’ve seen artistic visions of future Lunar and Martian cities replete with modern skyscrapers and flying roadways, all under protective domes of glass or some superior glass-substitute. We touched on this distant possibility in both of the last two issues. Certainly there is much more room for creative license on the part of architects working within the protected “middoor” volumes of megastructures like domes, and shielding vaults such as that illustrated in the Prinztown design study [see MMM #s 26–31, esp. # 29 p.4].

But looking at possibilities in the nearer term, when pressurized structures will be individually shielded, we might ask if Lunar and Martian xitiscapes can escape the mole mold of mound rows of shielding soil, hiding cramped lifespaces below. The appearance of this shielding overburden is our topic in the piece that follows: MOON ROOFS. Here let’s explore how architectural ingenuity can help a thriving Lunar or Martian settlement break out of the terrain-hugging rut.

Traditional skyscrapers here on Earth, as varied as they be in style, are basically vertically elongated boxes. Such a shape will not work well if it has to contain atmosphere under pressure against a surrounding vacuum. While higher surface strength to volume ratios

allow more freedom with very small structures, on the greater scale of the multi-story building exo-architects will have little option but to somehow adapt the sphere, cylinder, or torus, all of which do a much better job of equalizing pressurization differential stress. There is, to illustrate, no reason that a cylinder couldn't be employed in the upended position, properly anchored, with its internal floors perpendicular to its long axis, instead of parallel to it.

So much for meeting the pressurization challenge. We must still find a way to preserve shielding integrity. A simple outer sleeve a couple of meters (6 ft. or more) out from the cylinder's pressure hull, creating a wraparound coffer dam for filling with soil, would do the trick. But that certainly does not present the architect with a satisfying form of statement. The whole idea of multi-storied buildings is not merely to create an imposing silhouette against the sky, nor to make efficient use of high cost real estate, but also to allow visual access to the ambient outdoors sun/daylight and to the views generous window-walling can provide.

If you accept that such structures on the Moon and Mars would be occupied only part time by office-workers, for example, and if you restrict the field of unshielded vision to "a couple of horizon-hugging degrees" or so, vertically tunnel-visioning the view of anyone wanting to look out, the total averaged exposure to cosmic radiation from unshielded sky could be kept to an acceptable minimum, even on a long-term basis. If the simple illustration below reminds you a bit of the oriental pagoda with its tiered "pentroofs", that is no accident, for that is the source of the inspiration.

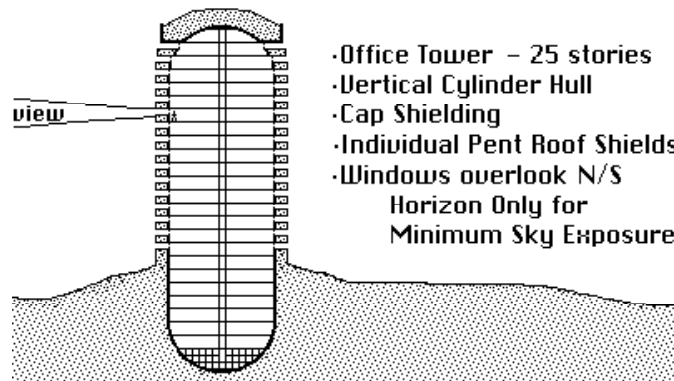

What appears to be balconies in this sketch, are really continuous cantilevered coffer dams filled with loose regolith soil shielding. Building occupants are restricted to the interior of the fixed pressure-holding windows to the inside of these "pent roofs".

This gives us an architectural "language" that can be used in yet more expressive forms. Below we have a vertically stretched torus "muff" surrounding a central cylindrical tower.

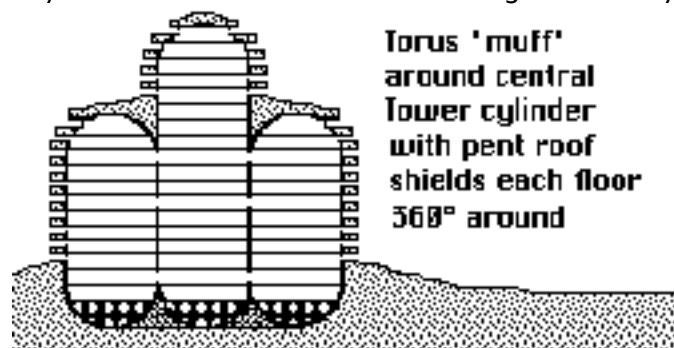

The inner and outer walls of the stretched torus would have to be constrained to shape by floor-incorporated cables under tension.

Another possibility may be to stack (co-axially, or perhaps stylishly off-center) story-thick sections of cylinders of decreasing diameter, each with an attached pent roof soil bin to

shield observers inside from the greater portion of the naked light-black, radiation-bright sky above.

The wider the diameter of each story section in proportion to its height, the greater the need to keep floor and ceiling in parallel, not by support pillars under compression, but by vertical (faux column hidden) restraint cables under tension. For unfortunately, the weight of the soil overburden sufficient to provide the needed amount of radiation shielding, is no match in the light lunar gravity (“sixthweight”) for the expansive pressure of the “atmospherule” below against the vacuum outside. On Mars where the gravity is two and a quarter times greater, the same amount of shielding soil mass will exert that much more of a stress-relieving counterpressure on the building “hull”.

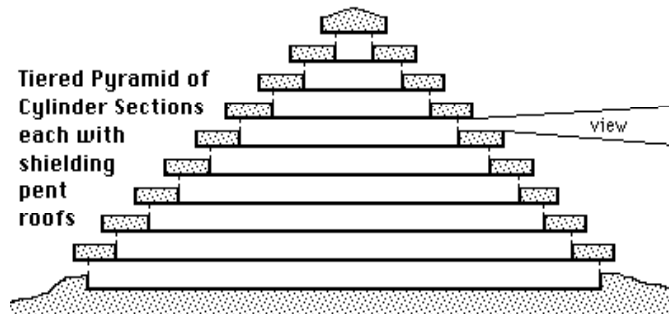

A less pretentious example of sky-scraping is given in the end-view cross-section sketch below, where a number of horizontally placed cylindrical pressure hulls are stacked. The advantage is in longer rectangular floor space.

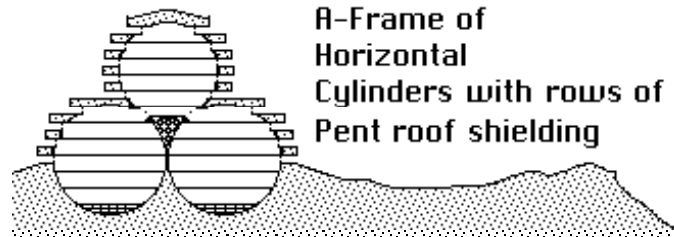

By whatever structural idiom it is stated, just as in some terrestrial cities, the skyscraper can be given even greater visual impact by siting it on high ground relative to the general surroundings (like the famed Shangri-la inspiring 2500-roomed Potala palace in the center of Lhasa, Tibet) e.g. on a crater wall or central peak, a scarp or lava flow front, etc.

And, of course, purely decorative unpressurized doodads such as spires and minarets or other façade-making hull-disguising decor can be added for tasteless kitsch allusion to one or more of the many Earth-legitimate building styles of past and present. We can only trust that most future Lunan and Martian architects will see the value of learning to express themselves in authentic world-appropriate forms. But it is a free universe!

Perhaps you can think of further distinctive directions in which future settlement architects can give vent to their vertical aspirations. If so, we hope you will send them in to MMM so we can share them with our readers.

**But, is there a need?** Will lunar settlements ever grow big enough for the real estate at their cores to become valuable enough to justify the extra expense of high rise construction? Certainly not if they are or remain government artifacts. But if settlement is enterprise driven, first supplying raw materials, then value added products, exploiting every advantage, and diversifying its own domestic economy, there is no reason why the number of pioneers on the Moon cannot rise into the hundreds of thousands or more within a half century of their founding. Remember, for a largely self-sufficient economy, the export sales needed to cover import costs will be relatively small. In the context of a rapidly diversifying economy, in comparison to the rise in exports, the growth of

the supported population can be exponential (e.g. a 10-fold rise in exports for a 100-fold rise in population).

The rise of settlement “downtowns” and of metropolitan and regional market centers should be expected if we are to have a real expansion of the human economy through off-planet resources, i.e. a spacefaring civilization. In this setting, the appearance of skyscrapers within or without enveloping xity megastructures should not be surprising.

But settlement skyscrapers should also not be seen as a foregone conclusion. While they might be considered for hotels, offices and corporate headquarters, residential condominiums, government buildings and so on, for each of these needs there are plenty of ground-hugging horizontal models. Indeed, if there has been adequate xity planning, the need for Manhattan style density should never arise. What multi-story buildings are built may be very modest by Earth standards.

=====  
**Rather than “scrape the sky”, lunar multi-story buildings will “break the horizon”**  
=====

Indeed there will likely be operative on the Moon a strong DISincentive to dense high-rise building: the neighbor’s right to unshaded access to the Sun’s valuable rays. This may mean that multi-story buildings must have proportionally great east and west setbacks, so that they do not rise above a certain rather low angle above the horizon, say 10°, at the property line. In such a situation, the vertical high rise is no longer an efficient use of real estate. (In theory, the best solution would be a very, very shallow broad-terraced pyramid.) The view (for residents or occupants) and the image (for customers and clients) then, may well turn out to be much more important drivers than the efficient use of “footprint”.

Terrestrial suburban office parks that have become common in the past decade, offer a more realistic inspiration for lunar high rise developers. Rather than “scrape the sky”, their constructs will break the horizon. Nonetheless, they will shatter forever the image of lunar towns as “mole hill city”.

Visitors to a lunar metropolis will ride “middoor” coaches plying the xity’s pressurized avenues within the shared biosphere. But they will also peer out over the surface xity-scape from shielded overlooks within the various high rises, and get a good outside perspective from the pressurized out-vac coach to and from the spaceport. Finally, in 1/6 G, a space needle observation tower could easily be a mile high! **TTTTT**



MOON ROOFS By Peter Kokh

Roofs on the Moon? – where it never rains or snows? Ah, but it does rain – a gentle slow micrometeorite mist, and a steady shower of cosmic rays, plus sudden ‘cats and dogs’ outbursts during solar flare episodes. While the characteristically imbricated (tile or shingle overlap) shedding features of terrestrial roofs would not be called for, the sheltering function of the 2–4 meters (6+ –13 feet) of shielding overburden above Lunar or Martian habitat space will be more than a little analogous to the familiar roof, a prehistoric heritage.

To the architect, the roof has traditionally been one of the most important opportunities for statement of style. To give some outstanding examples: the thatched English cottage, the terra cotta Spanish Tile roofs of the University of Colorado in Boulder, the green-patina copper

roofs of many early urban skyscrapers, the onion domes of St. Basil's in Moscow's Red Square, the tailored French mansard, and the Pagoda.

It would be natural for future settlement architects in the employ of well-to-do façade conscious homeowners to turn to the shielding blanket as a clay for expression. And for those hired by companies seeking a striking design for their new headquarters building, to turn to lunar "roofs", alias shielding, as a medium of style.

Already, purely for the utilitarian reason of simple convenience, some outpost designers are specifying that their habitats be neatly sand-bagged. The advantage of placing the loose lunar regolith in bags should be obvious. Not only will it keep the construction site cleaner – and safer (from dangerous bulldozer module collisions) – it will allow the bag-tamed shielding to be easily removed in order to repair hull and joint leaks, to make structural modifications, and to exchange old, or attach new, expansion modules. Meanwhile, by this simple trick of bagging, the external appearance of the outpost is drastically altered. The 'lith-bagged outpost now looks like an on-surface installation rather than an under-surface one, its appearance and presence radically transformed.

An alternative to the bag or sack (which could be made on site from medium-performance lunar fiberglass fabric) would be sinter blocks made from compacted and lightly microwave-fused soil. By varying the size and shape of such blocks and the patterns in which they are stacked, distinctive igloo-like styles should be easily achieved.

### **Grecian Formula**

It does not stop here. There is no cosmic law that states lunar shielding must be gray, or Martian shielding rust-hued. If desired, colorants can be added to the material itself, or glazed or even merely dusted on an exposed, rough surface.

In the early settlement, the availability of colorizers will not be great. On the Moon, Calcium Oxide, CaO, i.e. lime, made from highland soil will be a likely early favorite, probably cheaper than mare ilmenite-derived Titanium Dioxide, TiO<sub>2</sub>, also white. Either way, "white-washing" Lunar settlement shielding mounds might early on become "politically correct", for they would make the settlement a conspicuous very bright spot on the Moon's surface, perhaps even outshining the crater Aristarchus. This would make Earthlubbers more conscious, and hopefully supportive, of their frontier-blazing brethren above – a cheap way to put any Moon town in the "limelight"!

### **More than empty vanity**

By the simple addition of shaping or sculpting or colorizing, the shielding mound will become more than a visual disturbance of the surface. The 'lithscaper's or architect's touch can imbue the protective mound with design, unearthing the presence of the living and work space below and making the otherwise hidden structure visually present above the land-scape in an identifiable, pride-investing way.

This transformed self-image of the settlement may have real positive effects on the outlook, mood, and morale of the pioneers themselves. For it can be an early, easily won battle in a campaign to "humanize" the sterile barren alienness of their surroundings, thus contributing subtly to a sense of being "at home" in their adopted raw new world.

### **Economic opportunities**

Indeed, outside of the occasional observation cupola, for most surface settlement habitat architects, the "roof" may be the principal opportunity for exterior public-side statement (other than any openings to also shielded public "middoor" spaces like pressurized roadways, passageways or squares etc.) But the opportunities for "roof"-styling will more than reward frontier architects. This market will also provide entrepreneurial openings for enterprising settlers to develop the additives, the tools, the equipment, the processes, for making such on-paper possibilities real off-the-shelf choices.

### **Bower Roofing**

Nor need 'roof adornment' be an expensive luxury item. For it could also serve as an at least temporary 'banking' outlet for otherwise hard to recycle used building materials and other non-organic 'debris' – perhaps in shredded or gravelized form – and for various orphaned manufacturing and mining byproducts for which more suitable uses are not yet in sight. These are two stubborn categories which contribute significantly to terrestrial landfills, yet receive little if any attention. Here we could take a page from the bowerbirds (8 species in Australia, 8 in New Guinea) who decorate the interiors and entrances of their nests with "found" objects of all sorts.

### Settlement Signatures

Without attention to shielding style, it could well become a prevailing truism that once you've seen one surface frontier town, you will've seen them all. Given human nature and the slightest modicum of discretionary private and public funds, it is unlikely that such will be the case.

Distinctive 'lithscaping and "roofing" styles may become characteristic identifying trademarks, not only of individual structures, but of different lunar and Martian towns taken as a whole. And there will be economic incentive, and payback, for the small expense involved in the form of tourist interest in "local flavor". Long before any Lunar or Martian towns become large enough to begin to grow small high-rise "downtowns", they may become identified in the tourist mind by their individual mix of "roofing" styles. And all it will really take is a wee bit of imagination!

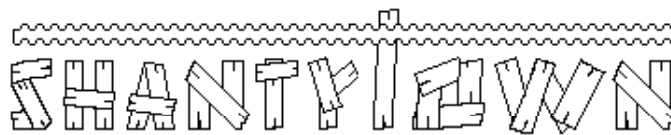

SHANTYTOWN

By Peter Kokh

We opened this issue with an IN FOCUS discussion of a current brash proposal to unilaterally open the Moon, or a large part of it, to homesteading. In all honesty, only space within a biosphere can be ripe for homesteading. In that sense, except for the obscenely wealthy, homesteading will not be an early way to open the space frontier. Some territory that is to be made "homestead-friendly" must be opened first.

Nonetheless, there will be at least temporary imbalances in the supply and demand for private residential turf on the frontier. Like it or not, there will be displaced persons, hard pressed to use their ingenuity to hustle up secured privacy (if not shelter) – within a constructed and maintained biosphere – using "found" cheap, if not free, discarded materials or by-products. There will be no outside ("out-vac") shantytowns hugging settlement walls. But there may well be cyclical or even persistent economic dislocation and quarterslessness within the containing biospheres of the Lunar or Martian towns and their early boom-bust economies.

To hide from this eventuality like an ostrich is not appropriate planning behavior. Rather, recognizing that this unfortunate sideshow of what we like to think of as mainstream human life might well follow us out into our new adopted extraterrestrial homelands, we ought to plan a gamut of strategies to deal with it. Barracks and dormitory space for newcomers, singles, estranged mates, and the elderly unwanted must be provided. The pace of public works outside the settlement, i.e. building new roads, outposts, supporting science excursions can all be speed up or slowed down as this labor pool grows or shrinks.

This said, there will still be those – hopefully only a few – who will be without proper personal quarters. But their numbers could rise in bad times faster than the public sector can make provision or adjustment for them. Within-the-walls temporary shantytown areas could be provided on an emergency basis to take up the slack.



## **Shantystuffs on the Space Frontier**

As with shantytowns on Earth, the building materials of choice will be those that are free for the taking. Discarded skids and crates and tankage and other packing and packaging materials stockpiled for eventual recycling could be drawn down for this purpose. Indeed it might take little in the way of cost or effort to manufacture such materials in the first place with an eye to this potential reassignment or diversion of use, making them shanty-friendly so to speak.

Many items will be co-shipped as “packaging” to the Moon with the expense debited to the C.O.D. cost of the packed items. The idea of choosing, manufacturing, designing and/or processing such “packmates” so that they are capable of diverse reuse, is one we have mentioned before. For example, we could choose to ship things in copper, lead, or other strategic “lunar deficient” metals that can be cannibalized latter. We could choose to formulate packaging materials out of low molecular weight solid hydrocarbons that can serve as chemical feed-stocks, or out of compostable molded materials rich in the micro-nutrients that lunar soil typically lacks, etc.

Manufacturing common shipping “tare” items so that they can also serve as easy-to-assemble shelter components, shouldn’t be difficult. This process of adding extra features to make unrelated reuse simpler, easier, and cheaper is called “scarring”. Given the hidden exorbitant cost of importing such co-shipments, it’d be foolish not to invest the relatively minor cost of scarring them to leverage the bootstrapping of the settlement economy. And when and if the need for “make-do” temporary housing disappears, these items could either be recycled or made available to entrepreneurs who can transform them into elements for durable and attractive housing.

## **Deliberate shantytowns and worse cases**

While we might hope that the need for all this proves to be minimal, it is on the contrary possible that some space frontier settlements, in the asteroids for example, may even be designed totally as shantytowns through and through. They would be set up to serve some temporary purpose, then fold up gypsy style, to be set up afresh in some new location.

Other space frontier towns, confidently designed and constructed as “permanent”, may suddenly find that the economic underpinnings of their survival have vanished through an evolution or revolution in technology perhaps, or through the opening of cheaper alternative sources of whatever they supply to the off-planet economy. If such a town has not moved early to diversify its exports, all or most of its inhabitants might suddenly become displaced. Without any alternate ways to hold on in “depression mode” until recovery measures can be realized, the need to shanty these people elsewhere may become urgent.

## **Differences from Earth**

Hopefully, the minimal intra-biosphere shantytowns that do arise will not be totally dismal places. Even in the worst favellas surrounding our exploding third world mega-cities, it is possible to find pockets of art, design, and obvious pride of place. For it is not the materials that are used, but the care and imagination with which they are used that make such differences. The talents for blending composition, for artful juxtaposition, for cheerful accentuation with color, etc. etc. – these are talents that are rare. But they are also free.

Given likely high standards for settler recruits, these talents may be less uncommon on the space frontier. Shantytowns that arise out there, might prove welcome exceptions, exuding hope and promise, rather than despair and resignation.

Space Frontier communities will not be utopias – not in any social sense (despite careful preplanning for special challenges) nor in any materialistic sense. It will be a long, long time before life on the Moon, Mars, the asteroids, or in free space oases will be as sophisticated or genteel as in most any city on Earth. This frontier, like all those that have come along before, will be for those who thrive on the rough edges and cheerfully rise to the challenge of softening those edges, rather than those who need to find them already velvetized. And when this frontier opens, those who value luxury, refinement, and being up to date or ahead of the Joneses, will

do best to stay behind on Earth. Space will be an opportunity to tame and create and overcome and contribute and sew, not soon an escape for those who would only reap and consume.

MMM

## MMM #66 – June 1993

### UTILITIES ON THE MOON

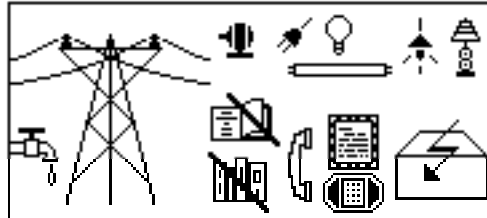

**Almost no Copper, very little Hydrogen or Carbon**

These are some of the more salient Lunar Facts-of-Life that severely constrain the design and operation of Lunar Utility Systems. Other handicaps include the lack of lead, silver, gold, platinum, tungsten, and key ingredients for known exotic high temperature (that of liquid oxygen or above) ceramic superconductors. Utility systems must be designed to maximize dependence on available Lunar substitutes. For a glimpse of how future Lunar Utility systems may operate read the articles below.



**How to best transport water, electricity, and information within and between settlements?**

**[PUB lic] u TIL i ty:** a business enterprise, such as a private or quasi-private public service corporation, chartered to provide an essential commodity or service to the public, and regulated by government.

### **Lunar Industrialization: Part III**

By Peter Kokh

Every human, civil, or industrial operation, function, or activity that we have examined in MMM promises to be transformed by its transplantation to a lunar or space settlement setting. What we call "public utilities" will be no different. Some of these transformations will be due to the characteristically unique set of economic constraints that will operate in the early settlement period. Other differences will flow from the physical nature of the host environment. Often from both.

#### **"MUS/cle" and the Local Production of Utility System Components**

Some utility system components are complex and might not be suitable priorities for settlement self-manufacture until the productive population is larger and the local industrial complex is well into diversification. Other items — happily often those which will account for the greater weight fraction of the total system — might well be locally made early on, helping to keep a lid on imports.

For example, supply and drain pipe, and shortly after most common fittings for a **Water Utility** may be produced from local iron (if an anticorrosive treatment other than zinc-based galvanizing can be found) or from Glax™, glass/glass composites (if not). Valves, meters and

regulators totaling a small mass fraction of the system, could be supported. Drainage pans for planter beds could be made locally of Glax, or sulfur impregnated fiberglass. Flexible water hoses might have to be forgone unless used only sparingly, in very short lengths — for they would have to be brought up from Earth.

To deliver water over long distances, it will make more sense to pipe the constituent Hydrogen either by itself, or with Carbon and Nitrogen, also needed everywhere, i.e. as methane CH<sub>4</sub> and ammonia NH<sub>3</sub>. At the destination, these gases could be burned with locally produced oxygen or run through electricity- and water-producing fuel cells during the nightspan.

For the **Electric Utility**, the mass-fraction set priority will be to locally produce cable and other media of power transmission, at least initially importing switches, outlets, relays, breakers, and meters etc. Later parts of these can be locally made, following the MUS/cle strategy. For more on this see “Wiring the MOON” and “Let There Be Light”, below. For long distance transmission, if locally made superconducting cable is not feasible, it may make more sense to transport electricity “virtually” in the chemical equivalent of gases that can be oxidized to produce electricity at the user destinations.

### **Rethinking Utilities**

Not only must utility system components be selected, and in some cases even redesigned afresh, to permit local manufacture of as much of the system mass as possible, in other cases whole new approaches must be adopted (per the examples above, using gasses to virtually transport water and power). In every case, the Utility must adopt a philosophy of operation altered from the one, or ones, which worked quite well on biosphere-coddled, mineral- and volatile-rich Earth.

The water company, for example, may require many industries to operate independent self-contained water treatment loops, their original water allotments in effect becoming “capital equipment”. The utility may also require separate drainage systems for diversely “dirtied” waste waters to simplify treatment. [“Cloacal vs. Tritreme Plumbing” MMM #40 NOV ‘90 p4 . MMM Classics #4]. Hydro-Luna will also be aggressively involved in finding new cheaper sources of water, or hydrogen, to make up inevitable losses and permit settlement growth, especially if lunar polar cold traps are found to be dry.

On the Moon there is likely to be a new boy in town, the **Atmosphere Utility**, charged **a**) with the makeup and expansion supply of nitrogen (and possibly a greater fraction of other, lunar producible buffer gasses like argon etc.) and oxygen; **b**) with maintaining their freshness and low dust count; and **c**) maintaining an equitable range of temperatures throughout the sunth (lunar 28.53 Earthday-long dayspan-nightspan cycle) and various agreed upon growing seasons, harnessing the conduction, convection, and radiation of heat.

These charges will require systemic cooperation with the Water Utility, both in maintenance of air quality through misting and dehumidification cycles, in fire prevention, and in temperature control, To do its job, this Utility may need to take a page from the Water Utility and supply not only a fresh air supply system but a stale air return system as well. Several Utility-relevant articles follow.

#### **Relevant READINGS FROM Back Issues of MMM**

MMM Classics #1 MMM # 4 APR ‘87 “Paper Chase”, Kokh – MMM #7 JUL ‘87 “Powerco”, Kokh

MMM Classics #2 MMM #14 APR ‘88 “Electric Options”, J. Davidson, R.J. Miller, L. Rachel, G. Maryniak

MMM Classics #3 MMM #23 MAR ‘89 “Gas Scavenging”, Kokh

MMM Classics #4 MMM #31 DEC ‘89 The PRINZTON Settlement design: “Multiple Energy Sources” , P. Kokh, M. Kaehny, M. Mullikin, L. Rachel, J. Suszynski; “HydroElectric Storage Systems”, Mullikin, Kokh; “The Laser Power Tower”, M. Mullikin – MMM #40 NOV ‘90 p4 “Cloacal vs. Tritreme Plumbing”, Kokh

MMM Classics #5 MMM #43 MAR '91 "Lunar Power Storage", A. Reynolds – p 4. "Dayspan", "Nightspan", P. Kokh

MMM Classics #6 MMM #51 DEC '91 p3. "Everfresh", Kokh – MMM #52 FEB '92 p5 "Xititech: Dept of Xity Biosphere"



WIRING THE MOON

## The order of the day will be to minimize the use of both copper wire and plastic sheathing

By Peter Kokh

Until 1966, Copper was the exclusive conductor of choice both for long-distance electric power transmission and for wiring systems in individual buildings and vehicles. For Copper is both economically producible (since 3000 B.C.!) and the best conductor known. In contrast, Aluminum, the second best conductor, was first introduced to the public in this century as a semiprecious metal and did not become truly affordable until mid-century. By the mid-60s, its price had fallen low enough that contractors could save as much as \$200 a house by installing wiring systems that used Aluminum.

Aluminum wiring soon earned a very bad name. The problem was that the outlet receptacles used with it had steel terminal screws, an unwise and inappropriate choice that lead to "dangerous overheating causing charring; glowing; equipment malfunction; smoke; melting of wire, wire insulation, and devices; ignition of combustible electrical insulation and surrounding combustible materials; fire and injury and loss of life." So stated the U.S. Consumer Product Safety Commission, plaintiff, in its successful suit against Anaconda and 25 manufacturers and suppliers, in banning "Old Technology" Aluminum Wiring Systems in 1973.

While Aluminum wiring has been little used since, a perfectly safe and CPSC-approved "New Technology" system is available. Very simple: just substitute brass terminal and connection screws. So aluminum wiring systems for the Moon are ready to go. The amount of copper contained in the brass screws is really trivial in comparison to the amount saved by substituting aluminum wire. Until outlet and switch devices can be made substituting lunar glass or porcelain for the plastics now used, such devices – with brass screws – could be simply imported. They do not weigh much and are not bulky.

But that only meets half the challenge. There is the matter of all that carbon and chlorine based plastic sheathing! We could first of all greatly reduce the amount of sheathing needed by giving up modern Romex cable for older technology rigid aluminum conduit (or glass – glass/glass composite) or for the flexible metal conduit (BX) used by an earlier generation of do-it-yourself installers.



- KEY: A. Modern flexible plastic sheathed ROMEX cable  
B. Rigid or flexible grounded conduit, copper wire  
C. The same with aluminum wire

Either way we save the shared sheath which makes up the romex, and as a bonus (with aluminum conduit) save the grounding (earthing) wire. We'd still need insulating sheathing for the individual hot and neutral wires, and about 67% more of it because of the switch to Aluminum which needs a larger cross-section to carry the same current as Copper.

The next step in designing a lunar-appropriate wiring system is to devise lunar-producible wire sheathing. Fiberglass fabric is one place to start. If you've ever seen a pre-WWII lamp, you may have noticed the frequently frayed cotton fabric-covered lamp cord wire. If some plasticizers are needed to keep the fabric sheathing supple, perhaps some thio-silicone (see MMM # 63 "SILICONE ALCHEMY") could serve.

Other ways to save include lower voltage systems (like the 12 volt systems used in recreational vehicles and remote site cabins) and tighter, more centralized distribution networks. On this, more below.

Finally, a considerable amount of copper is used for the wire bindings of electric motors and generators. It will be desirable to begin producing early on the heavier commonly needed motors and generators on the Moon. Has anyone experimented with aluminum motor bindings and gotten past any initial discouraging results to produce something workable? MMM would like to know. If you know, write. MMM



LIGHT DELIVERY SYSTEMS FOR LUNAR SETTLEMENTS NEED TO BE RETHOUGHT

**To minimize the mass fraction of bulb and other light system components that must be imported, careful, even novel choices might be in order.**

By Peter Kokh

I have never seen a reference that gives any indication that anyone else has ever considered the unwelcome problems posed in the continued importation to a lunar settlement of lightweight but bulky and fragile (therefore over-packaged) light bulbs and tubes. It would seem to me that the lunar manufacture, or at least final assembly, of such devices would be somewhere in the upper third of the list of priorities. The problem is that each of the growing number of diverse lighting bulbs and tubes incorporates some elements not native to the Moon in economically producible abundances.

Our familiar everyday **incandescent** light bulb is quite reliant on tungsten wires and filaments for which there is NO practical substitute. The amount of tungsten involved is, however, trivial, and could be affordably imported, preformed and ready to be assembled with Made-on-Luna glass bulbs and mounts. The screw-in or bayonet base can be aluminum with a minimal amount of brass needed for the contact points. The evacuated bulb can be filled with lunar Argon gas. Available coatings include phosphorus produced from known regolith KREEP deposits. Light bulb manufacture is among the most highly automated, with about a dozen people needed to make most of the incandescent bulbs used in the U.S. (per manufacturer). Lunar production would not hog precious person power.

High intensity halogen lights would necessitate the importing of either bromine, iodine, or fluorine gas along with tungsten filament. To save energy, other light bulb types and fluorescent tubes may be preferable. But energy savings must be weighed against the gross mass of ingredient materials required that must be imported on an ongoing basis.

Early **fluorescent** tubes were filled with mercury gas and had UV-sensitive phosphorescent coatings of calcium, magnesium, or cadmium tungstate; zinc, calcium, or

cadmium silicates; zinc sulfide; borates of zinc or cadmium; cadmium phosphate; finally calcium phosphate. Only the last would be a good choice for lunar manufacture.

In addition to the phosphor used, a relatively small amount of activator to facilitate its excitation is necessary: among these copper, silver, antimony, and bismuth are not lunar-appropriate; thallium may be so someday; and only manganese will be available locally any time soon. However, the small amounts needed should not be a problem to import. Greater challenges are the sophisticated process needed to produce the coating in 2–8m size and the organic binding material needed to coat it on the glass.

The recent development of **Light Pipe** technology suggests an altogether different approach to indoor lighting on the Moon. Instead of a multiplicity of individual lamps and light fixtures, a network of Light Pipes whose rib-faceted inner surfaces channel light without appreciable loss to locations remote to the light source could be built into each building, ending in appropriately spaced and located Light Ports.

A central bank of efficient high-pressure lunar-appropriate sodium vapor lights could feed the network during nightspan, sunlight feeding it by dayspan, to form an integrated light delivery system, part of the architect's design chores. Delivery Light Ports could be concealed behind cove moldings to produce ambient ceiling illumination or end in wall ports that could be mechanically variably shuttered or dimmed from full "off" to full "on." If the reverse side of such shutters were mirrored, the 'refused' light would just go elsewhere and not be lost. A low voltage feedback loop could match supply, the number of central bank lamps "on," to the number of Light Ports open.

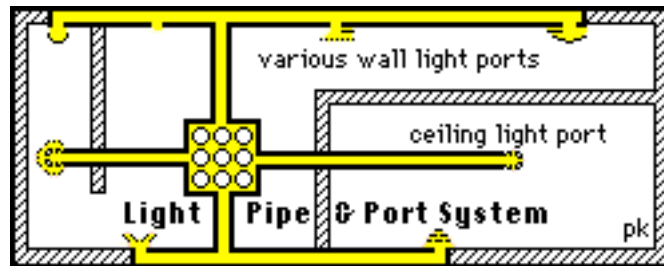

Wall and Ceiling Light Ports could then be fitted with any of a growing choice of consumer purchased and artist designed decorative plain, etched, or stained glass; or pierced metal diffusers; or fiberglass fabric shades. Such a system might allow the number of types of bulbs that need to be manufactured to be minimized, allow the use of the most efficient bulb types, appreciably reduce the amount of wiring needed, and still allow wide decorator choices.

MMM

**MMM #67 - JuLY 1993**

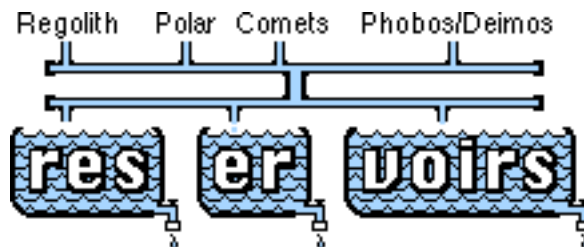

WATER RESERVOIRS By Peter Kokh



Certainly for smooth running and timely growth of lunar settlement and industrialization we will need substantial water reserves in excess of those actually in domestic, agricultural, commercial, and industrial cycle use. In addition to the recreational uses of water in deodorized stages of treatment suggested in the article that follows, additional fresh reserves can be used for recreational and landscaping use. The in sight availability of such reserves will be reassuring to the settlers, and obvious drawdowns a cause for political concern and action. Such extra open water reserves could support wildlife and additional luxury vegetation. Another use of fresh open water storage is as a heat sink to control the climate of the settlement biosphere.

Inactive storage of water-ice made from hydrogen co-harvested in Helium-3 mining operations or brought in by Hydro-Luna from various off-Moon sources can be cheaply provided in lava tubes. The first waters would quickly freeze and self-seal the tube from leakage. When needed, ice could be cut and hauled by truck or conveyors to pressurized areas for thawing and use.

Handy lavatube storage will be available in many mare areas and will be a consideration in choosing settlement sites. Where settlements or outposts are desirable in areas devoid of such underground voids, there are other options: Hydrogen gas can be stored above ground in pressurized tanks, but to prevent leakage and other problems, a better way to store it would be as methane or ammonia, either liquefied or as pressurized gasses. Conveniently, it is in such form that out-sourced volatiles will be imported in the first place. Further, storage in this form is very versatile allowing volatiles to be drawn down, resupplied, or shipped elsewhere all by automated pipeline systems. As a bonus, at the use market destination, they can be run through fuel cells or steam turbine boilers to generate electricity as well as water and other volatile products.

Both methane and ammonia have major agricultural and industrial uses. In both cases, introducing added water into these cycling systems through this form makes elegant sense.

How much of a Water Cushion should the settlement strive to maintain? New water must be added not only to support growth in population, agriculture, and industry but to make up for inevitable losses. While major attention must be paid to preventive strategies to minimize losses of water in the various loops, accidental and other difficult to prevent losses will still occur. These need to be made up and the rate at which such make-up additions are needed will greatly affect the local "cost of living" and indirectly, the "standard of living."

It would be wise to have a 2 year reserve sized not only for make-up use but also for planned growth. With quick additions difficult, planning and foresight are needed. MMMM

# The Settlement Water Company



## Care and Treatment of a Finite Resource

By Peter Kokh

### Industrial Exclusions: "Closed Loop" water systems for some industries

While even on Earth, abundant water for industrial use is not something everywhere to be had, in general, water supply is simply a matter of location. And given a wise choice of location, both the supply is cheap and the discharge is easy.

Water is used to move raw materials in slurries. It is used alone or with detergents as a cleaning medium. It helps separate particles by size, powders floating to the surface, heavier particles precipitating to the bed. Doped with emulsifiers it helps separate suspended materials normally impossible to separate.

Water itself serves as a chemical reagent. But more frequently it is used as a delivery medium for other more reactive dissolved chemical reagents.

A fine-tuned jet of water under pressure can be used as a cutting and shaping tool. Pressurized abrasive suspensions can wear away stubborn surface deposits.

Water is used in enormous amounts to cool by carrying off surplus waste heat. Combined with a heat source, it becomes a source of considerable power – steam! – the genie that unleashed the industrial revolution!

Its hard to see how we can even talk about industrial operations on the Moon if water is a scarce item! Clearly, in a situation where the water source is not constantly and automatically replenished, an abundant naturally cycled freebie, it becomes instead a very finite capital endowment that can only be replaced at great cost. Even if replacement charges can be lowered to mere thousands of dollars a ton or cubic meter, water will be “fanatically” recycled.

Nor would it make sense to funnel point source industrial discharges laden with particulates and chemicals into the general residential-commercial water system of the host settlement community. It will be far more efficient for each industrial operation to recycle its own discharge water – water that is still dirty in a known and limited way – before it gets mixed with differently polluted discharges from rather diverse industrial operations elsewhere.

Industrial operations then ought to have closed loop water systems. Not only does this make the job of water treatment much easier and simpler, it provides strong incentives for more conservative use of water contaminants in the first place. Plant engineers responsible for the water cycle will want to keep their job as simple as possible. Chemical agents used in industrial processes will be chosen not only for how well they work, but for how easily and totally they are recovered.

Where water is used for cooling, there will be strong incentives to cluster facilities that discharge heated water with operations that could put such a heat source to good use. A “thermal cascade” then becomes a natural way to ‘organize’ an industrial park – ‘organically’. An alternative is simply to store heated water for nightspan use to even out indoor and middoor (pressurized commons) temperatures throughout the sunth (lunar dayspan-nightspan cycle 28.53 standard 24 hr days long).

### **Double Duty Storage of Water Reserves and of Water-in-Treatment**

The water utility – both that of the Settlement at large and those in-house systems used in lunar industry – will have three types of water “pools”: **a)** clean, ready-for-use reserves, **b)** waste water awaiting treatment, and **c)** water in process of treatment (settlement pools or cooling ponds, for example). For the first two categories, there are both essential and luxury morale-boosting uses of water that are quite compatible.

Stored water can be put to good use in maintaining comfortable temperature and humidity conditions within the settlement. By freezing and or boiling some of the supply at appropriate times in the dayspan-nightspan cycle, the water reserves can act as a heat pump, be part of a heat-dump radiator system, etc. For water in treatment, distillation during boiling can work triple duty both to clean the water, regulate thermal levels, and produce power via steam.

Recreational use of stored water is not something to be overlooked. Even water in later “deodorized” stages of treatment may be clean enough for fountains, gold fish ponds and trout streams, and for boating lagoons and canals (“no swimming, please”). Nothing does more to boost the general ambiance and feeling of being in a “paradise” than generous, seemingly profligate, but totally self-conserving use of water. Judicious use of water reserves will be a primary function of the settlement water utility.

### **Making Treatment Easier – Smart Drainage Systems**

As was pointed out above in the discussion of closed water loop recycling systems for individual industrial operations, it makes sense to keep separate, waste waters that are still diversely and relatively simply dirtied. Why mix waste water from a can-making company with that from a canning operation? More, why mix either with agricultural runoff? Or agricultural

and garden and landscaped area runoff with human waste drains, or any of the above with bath and shower water?

In a previous article, “**CLOACAL vs. TRITREME PLUMBING**”, MMM #40, NOV ‘90 p. 4, [reprinted in MMM Classics #4] we discussed a revolution in drainage philosophy, the first great leap forward beyond the Cloacal (one hole) system invented in Mohenjo Daro (200 mi. NNE of modern Karachi, Pakistan) about 4,000 to 4,500 years ago. Simply put – separate color-coded or otherwise differentiable drainage lines for diversely dirtied waste waters so that they can be separately and more simply treated and recycled. Here on Earth, where in every established community drain lines and pipes make up a major component of entrenched (both senses!) infrastructure, it would be prohibitive to replace them with a more sensible network.

But on the Moon, where we are starting from scratch, the additional upfront costs of “doing drainage right”, will pay off immediately in lower upfront costs of treatment systems, as well as continually thereafter in lower operating costs for the whole communal water system.

### **Double hulling, drip pans, leak sensors**

When it comes to the Earth’s waters, Nature clearly pays no heed to the Proverb: “a place for everything, and everything in its place!” Even if the settlement shares a common megastructure atmospheric containment hull, it will be sound practice to keep water drainage systems and basins leak free, or at least leak-monitored and controlled. The separate drain lines might still be clustered over a common drip gully or gutter. As with modern gasoline (petrol) underground tanks, double hulling would be a wise policy. What is flowing or pooling around loose, even if technically still within the biosphere, is neither being effectively used nor recycled in timely fashion.

### **Humidity Control**

Humidity could be a problem, especially given the high concentration of green vegetation needed to maximize the biological contribution to the clean air & clean water cycles. Plants transpire lots of moisture into the air.

While writers dream of biospheres in which “it rains” from time to time, for it to rain naturally may require an insufferable prior buildup of humidity, with all the damage that can do (mold etc.) in addition to simple discomfort. Instead, giant muffled dehumidifiers will be needed, and the nectar they wrest from the air will be the start of the clean drinkable water cycle. Yes rain cleanses the air of dust and other contaminants, but so can the artificial rain of controlled periodic misting, the abundant use of fountains and waterfalls, etc.

### **Rules — Protocols — Restrictions**

Even water-dependent cottage industries, households, and individuals will have to accept some responsibility for wise use of the “liquid commons”, if they are to continue to enjoy its freshness, cleanness, and adequate abundance. Students may well be taught good cleaning, bathing, cooking, and gardening water use in unisex home economics courses.

Graduating youth may enter a Universal Service and spend some time manning all the infrastructure utilities upon which lunar survival is closely dependent, including the water treatment facilities. This too will foster thoughtful citizenship.

Water use might well be metered by progressive rates: rather reasonable prices for reasonable amounts; unreasonable prices for unreasonable amounts. Some home enterprises may need to seek Utility help in setting up closed loop water purification systems of their own: fabric dyers, for instance.

Mail Order Catalogs of items available to Earth may have pricing tariffs favorable to the import of items high in H, C, N, for example, and unfavorable to the import of items for which lunar-sourceable substitutes are currently “on line”.

### **Agriculture and Horticulture: Drip-Geoponics versus Hydroponics**

In agriculture and home gardening alike, the naturally buffered, lunar regolith-using geoponics systems using drip irrigation should be more economical than hydroponic systems that import all nutrients from Earth, not just some of

them. Water use in such systems can be controlled well enough, and indeed natural soil farming may be an “organic” part of the water treatment cycle. Here, as elsewhere on the Moon, water can’t be used casually anymore. MMM

## MMM #74 – April 1994



**moon manor not**

MOON MANOR NOT

\* [modified house clip art courtesy Hypercard™]

When settlers finally get to “settle in” on the Moon, moving out of the sardine can and into habitats built of local materials, their new “homes” will be quite different from anything we are used to. Yet the new abodes will fill the same basic needs. This month, MMM begins a new series. We open with some “prerequisites” for lunar architecture 101. How will we provide Visual, Solar, and Utility Service Access? — below

### Introducing a NEW MMM Article Series

Many a novel has been written set on the Moon. Yet the reader never gets an idea of what a lunar home might, or could be like. Had the scene been anywhere on Earth, these authors would have dropped plenty of descriptive mood-setting details. But here, where none of them seems to have a clue, they leave not just some things, but everything to the imagination. Even Heinlein in his “The Moon is a Harsh Mistress” speaks only vaguely of the city and its underground “warrens.”

Those who have only NASA achievements and plans as a guide are neither better nor worse off. The teacher we must turn to is neither any one of the science fiction writers, not even all of them pooling their collected insights, nor NASA-aerospace metal-bending engineers – but the Moon itself.

What sort of shelter can future homesteaders create relying on local resources, fashioned, constructed, finished, and decorated in local conditions? As on Earth, the constraints imposed by the suite of available materials do not dictate everything. There will be room and plenty of it, for architects, craftsmen, and artists to create ever new expressions of form, function, comfort, harmony, utility, and beauty. We might predict that in a world with steep economic disincentives to import from the endless diversity of wares and wears of Bazaar Earth, the role of local architects, craftsmen, and artists in providing distinctive and personal expressions from a limited but slowly growing number of choices will be much prized.

Some things will be the same. People need space: private space to mold in expressing their own personalities and into which to retreat; and communal space in which to be

comfortable together. Sardine cans won't do. Indeed, against the stark sterile barrens outlooks, we'll need even more structured per capita space for real comfort than do modern Americans.

Other things will be different. With no transcending natural biosphere as a cradle, homesteading as we have known it will be orders of magnitude more difficult.

This month we talk about some of the features we'll want to insist upon. Next month we turn to the architectural possibilities for Made on Luna modular housing. After that, we'll discuss how lunar home interiors can be decorated and furnished, and the role they'll play in settlers' lives.



#### **READINGS From Back Issues:**

[Republished in MMM Classics #1] – MMM # 1 DEC '86 p. 2. "M is for MOLE". – MMM # 5 MAY '87 p. "Weather?"

[Republished in MMM Classics #4] – MMM # 37 JUL '90 pp. 3–5. "Ramadas," "Flare Sheds".

[Republished in MMM Classics #6] – MMM # 55 MAY '92 p. 7. "Moon Roofs".

SHIELDING & SHELTER By Peter Kokh

On Earth, "Roof" and "Shelter" are synonymous. The roof (along with the walls, doors, and windows) protects those underneath (within) from the wind and rain and other discomforting atmospheric phenomena. A well designed roof is also a major part of the home's temperature modulation apparatus. And always to the builder and/or architect if not always to the homebuyer (almost never the renter), the arbitrary aspects of the roof's design are key to the style of the home as a whole.

We go through life mostly unaware and unappreciative of the fact that some of the ways in which we are "sheltered" are "given", provided in common for all without our need to be concerned (until recently) by the Earth's warm moist blanket of breath-giving air. The atmosphere "shields" us from most cosmic rays, most ultraviolet light, most solar flares, and most meteorites. And it works with the oceans to greatly moderate the much greater temperature extremes to which we would otherwise be subject.

On the Moon, we will have to provide for ourselves both shelter and shielding. The pressure hull of the individual habitat, or of a shared megastructure, will be something new, keeping atmosphere and moisture captive within – something we have never had to do before (at least until the dawn of air conditioning and more recently of determined thermal conservation). Atmosphere and hydrosphere recycling functions must be brought indoors in the process.

Those storms left outside, just outside, are those left miles above on Earth. To do this, we have to provide the equivalent of miles of atmosphere in a condensed solid or liquid form. Fortunately, the loose lunar regolith soils or Moon Dust that blankets everything 2–10 meters (yards) thick will do the trick quite nicely. So we can think of this shielding overburden as a solidified atmosphere – at least in this respect.

Unless the lunar home lies within the shared lee space of a common shielded megastructure, it must provide both shelter and shielding. The hostility of the universe at large will be held much more closely and fragily at bay. A lunar home will be a refuge in a much more intense and dedicated way than any terrestrial one. Surface temperature extremes are a

case in point. Fortunately, lunar regolith used as shielding is an ideal moderator. A couple of meters down, the ambient temperature does not vary by more than 3 degrees Celsius all year, being highest in March, lagging perihelion in early January, lowest in September, lagging aphelion in early July.

Locally derived shielding can be provided in several forms. Loose regolith can be spread, dumped, blown, or bulldozed over the top and side banks of the structure(s) to be protected. Or the same material can be poured into lunar fiberglass “sandbags” or sintered into igloo-making blocks and then put in place. For those who can afford shielding with an 11% exotic imported content, water made with local oxygen can provide shielding and translucency alike. All-lunar glass block may be a cheaper and thermally more forgiving way to provide the same effect over glass-top habitat hulls.

Earth’s roofing professions hardly supplies expertise needed for the much bigger job on the Moon. Here, “Shielding Engineers & Contractors” will be among the most prestigious headings in the settlement Yellow Pages. Making their job more challenging will be the need to provide for easy shielding handling and removal when existing habitat space must be replaced, repaired, retrofitted, or modified externally, and even expanded with add-on additions. Their expertise will be needed also for retrofitting interior visual, solar, and added personal and utility access to the surface.

In short, a lunar home will have to take its refuge and safe haven providing function much more seriously and less casually than even its most thoughtful terrestrial counterpart. Home Sweet Home will be a sentiment more appreciatively felt than ever before.

MMM



#### READINGS From Back Issues:

[Republished in MMM Classics #1] – MMM # 1 DEC ‘86 p 2. “M is for MOLE”

[Republished in MMM Classics #6] – MMM # 55 pp.? visual access (lunar skyscraper article)

#### VISUAL ACCESS By Peter Kokh

The one single event that got me most excited about the possibility of lunar settlement was an ‘85 personal tour of a unique “earth-sheltered” home called Terra Luxe (Earth Light) about 30 miles northwest of Milwaukee in the Kettle Moraine glacial relic area. Built by architect George Keller (German for cellar), Terra Luxe is unique in having no sun-exposed south façade. Yet despite an earthen overburden 8 ft. thick, the place was flooded with sunlight from mirrored shafts in the ceiling fed by sun-following mirrors. More to the point here, in every outside facing wall was a 4’x8’ picture window out on to the picturesque countryside. This neat trick was accomplished by a pair of rectangular mirrors set at 45° angles in a vertical shaft – “periscopic picture windows” so to speak. To this date, I have never been in a house so refreshingly wide open to the landscape all about as here at Terra Luxe.



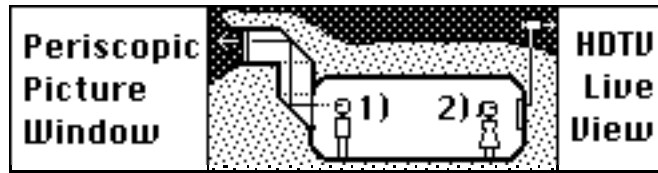

PERISCOPIC PICTURE WINDOWS VS. HDTV LIVE VIEW

Could such a system for real visual access be in some way adapted to lunar conditions? Why not? The glass used could be reinforced with transparent glass fibers (in lieu of lamination with plastic, as we might do here) and be somewhat thicker. Then there could be a pair of horizontal panes at the bottom and top of the vertical shaft (see dotted lines in sketch above) to allow the atmospheric pressure between them to be gradually stepped down to reduce the stress on any one pane, e.g. 0.25 ATM, 0.5 ATM, 0.75 ATM (or similar percentages of whatever the interior habitat pressure was set at). Finally, an easily replaced “sacrificial” glass composite meteorite shield can sit in front of the outermost pane of the sealed periscopic unit. The “Z-View” unit would preferentially have north or south exposures so as not to admit the rising or setting sun (unless equipped with automatic (hence failure-prone) shutter system). Meanwhile, the indirect visual path would preserve full line-of-sight shielding for the habitat occupants.

It would seem that such fixed units with no operating parts would be both strong enough and well enough protected to be built in genuinely “picture window sizes. These units could be standardized preassembled and tested modules made to be snap-installed in standardized habitat wall “rough openings.”

Of course, there is the electronic solution of thin, hang-on-the wall ultra-high-definition television view screens (“you can’t tell it from real” will go the hype) for those who dislike KISS (keep it simple, stupid!) solutions and who can trust that the signal received is coming in untampered, and live and that neither their “window sets” nor the surface telecams that feed them will ever break down and need costly repairs. I’d like to see both options pursued and predict that both will find ample market share in a growing settlement.

A third solution is the cupola observatory. Here direct views of the surface are afforded while maintaining a very limited sky exposure, thanks to the generous shielded eaves.

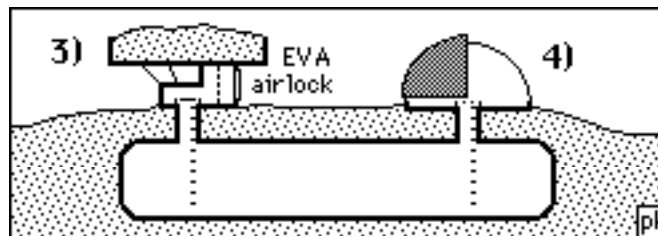

A fourth solution is the surface dome, with a clock-driven sun-following shade screen. This would open the view to the star spangled sky, and to Earth for homes on nearside. The penalty, of course, would be accumulated cosmic ray exposure and thus the need to budget time spent therein.

Perhaps some would expect visual access to be a neurotic need of the few unadjusted persons. Who needs to be reminded of the hostile life-threatening radiation-scorched surface when interior spaces can be made so comfortable and reassuring. But I suspect lunar settlers will come to appreciate the unique beauty of the magnificent desolation outlooks and enjoy monitoring whatever surface activity there is outside their safe underground homes. Providing real-time true vision exterior visual access to all will promote acculturation to the Moon and a healthier, more balanced morale. PAPA



## Letting in the glory and warmth of real Sunlight

SUN MOODS By Peter Kokh

### READINGS From Back Issues:

[Republished in MMM Classics #1] – MMM # 1 DEC '86 p 2. "M is for MOLE"

[Republished in MMM Classics #3] – MMM # 27 JUL '88 p. 5 "Ventures of the Rille

People:

Pt. II. Rille Architecture General Concepts. D. Letting in the Sun"

[Republished in MMM Classics #5] – MMM # 43 MAR '91 p. 4. "Dayspan"

[Republished in MMM Classics #7] – MMM # 66 JUN '93 p. 7. "Let there be LIGHT"

On Earth we take sunshine for granted. Not that it's always there! Nor that we don't appreciate a nice sunny day! But the point is, we get to go outdoors and bask in it– at least once in a while. On the Moon, the Sun shines gloriously, free of even a wisp of cloud or haze, for fourteen and three quarters days at a time, before setting for as long. One hundred percent predictable. But! We can't go "outdoors" to enjoy the brilliance it confers on everything nor its warmth on our face or back – not without cumbersome space or pressure suits. Nor will it automatically flood in through simple windows.

Two things are clear. We will have to enjoy the Sun indoors, and we need its rays to bathe us and our living space from above. Living underground, or under 2–4 meters (yards) of lunar regolith shielding, one might expect that to be a neat trick. Not really. Sunlight can be captured by a Sun-tracking mirror or heliostat and then directed via a broken path (to preserve line-of-sight shielding) to various points along the ceiling (or walls, if deflected upwards). Such a pathway can have a number of intermediary sealed panes to step down the interior pressure, just as in the Z-View window system described in the piece above. Option a) below.

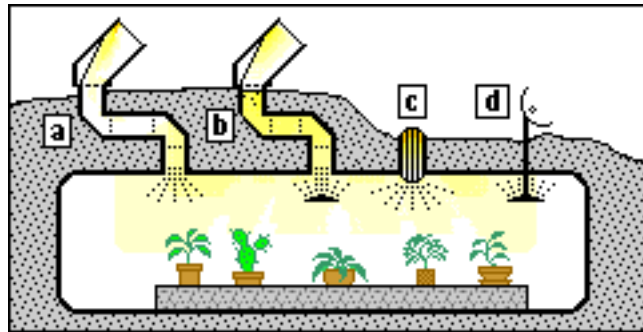

Option b) is similar but the light is deflected against the ceiling. Option c) uses a smaller diameter direct path filled with bundled glass fiber-optic strands in a sealing matrix. This also preserves shielding, substituting glass for dust. It could be coupled to a heliostat or not. The bundle can just as easily be branched to produce little pools of built-in spot and mood lighting at various places within the habitat. As such, it would be an important part of architectural decor and setting.

Option d) produces electricity from a solar unit at the surface and regenerate "sunlight" electrically within the habitat, faithfully repeating the visible spectrum distribution and intensity. Artificial sunlight does work! I have seen convincing "skylights" in the basement ceiling of a seven story office building. The light pools beneath them mimicked bright sunlight quite effectively. Over-illumination (compared to comfortable reading and task lighting) is as much a key as color fullness. So this option is a possibility where direct funneling of true

sunlight is impractical: in lower floors, in lavatubes, and during nightspan. Actually, even where directly channeled sunlight is quite feasible, the natural and artificial systems can be combined, with artificial “sun lamps” on the surface feeding sunlight delivery systems during nightspan.

Over-illumination, is itself quite therapeutic, flooding interior spaces with all the light you’d experience in the middle of a Kansas cornfield on a late June noon under a cloudless sky. Such intense lighting can be applied in garden areas, for example; or in a private meditation chapel, or public church, filtered through stained glass art panes.

So far, we have only spoken of ways to bring the sunlight into the interior of hard-hulled regolith-shielded habitat spaces. But the upper portion of a habitat module can be made of translucent glass composite, with the shielding provided by glass blocks. [1] That much glass would cut down on the amount of light being transmitted appreciably. But if desired, this loss could be compensated by reflecting several suns’ worth of light upon the outer surface with the aid of peripheral mirrors.

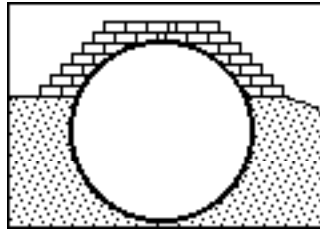

A combination of conventional and glass block shielding is a more modest possibility; for example, a clerestory of glass block used on the sun-facing bank of a structure running east-west.

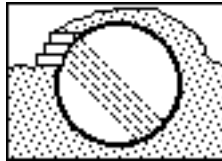

Finally, liquids also provide both shielding and translucency. We have to have stored reserves of water at any rate, and storing it overhead as translucent shielding is a Marshall Savage suggestion that deserves attention. This combo fresnel lens bottom water skylight – solar hot-water tank is our own idea.



A more ambitious project is to use water shielding over a glass-domed or glass-vaulted garden-atrium or farm module.

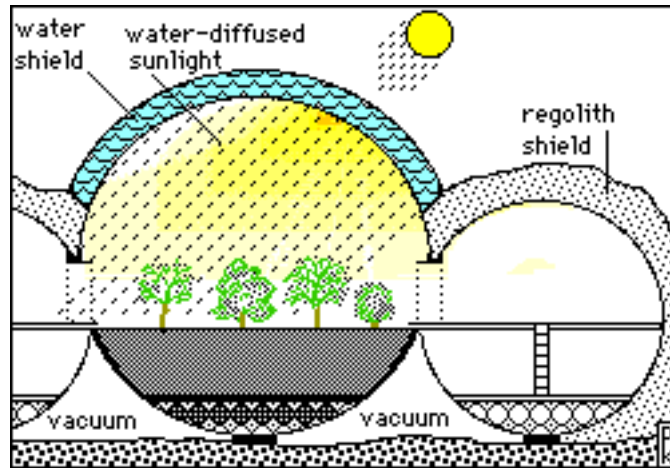

In "The Millennial Project", p. 209, Savage suggests circulating the water through cooling tanks to keep the water shield under thermal control. More on this another time. FAMMA

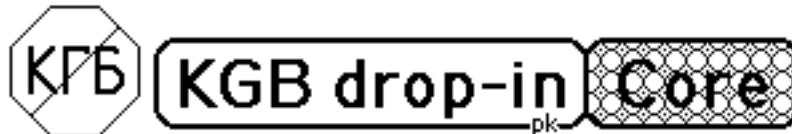

KGB drop-in Core By Peter Kokh

No, this isn't an article about an unreformed cadre of commie secret police dropping in unexpected and unwanted to harass peaceable lunar settlers in their homes. Rather by "KGB" we mean Kitchen, Garden, Bath (& Laundry). "Drop in Core" (€orps) means a standardized preassembled combination plumbing, air circulation, and electrical and communications service entry package needed to make a modular pressurizable architectural shell into a habitable home. Just add furniture, furnishings and people – those very things that personalize and customize each dwelling beyond initial floor plan choice.

The point is that on the frontier, on any frontier, there is a severe labor shortage. When you're pioneering a settlement from scratch, there's always far too much to do for far too few people. Labor-saving measures are vitally essential, especially in all the steps necessary to bring a new structure to the point that it can be occupied. It will be imperative to do this as fast as possible, in a couple of days per housing unit perhaps. Once inside, the new residents can take their blessed time "finishing" their new abode, personalizing it to taste.

That is the stage where labor-intensive options are appropriate – and not before. And in the early years, such work will be done "after hours". For every 'able-bodied' person available will at first have to be primarily employed in the manufacture of exportable items, in settlement maintenance chores (biospherics, air/water systems, food-production) or in bare-bones settlement expansion as we've just described. (Almost all the paper-pushing jobs will be electronically farmed out to support personnel on Earth, far cheaper to support).

Drop-in plumbing cores have long been one of the more common tricks of Manufactured Housing, prefabricated in an automatable factory assembly line in controlled quality conditions with major savings both in labor-hours and labor-rates. The idea is not new. I first came across it in the mid-sixties when Israeli architect Moshe Safdie was planning his still stunning contribution to Expo '67 in Montreal. Habitat '67, still standing and occupied as Cité du Havre. If you've never seen it and ever get to Montreal, this mind-expanding complex is worth the side trip. But it may well be that other innovative builders had used the idea previously.

Lunan KGB Cores contain the water supply, drainage connections, fresh air entry, stale air exit, preliminary water/air treatment and thermal control equipment, electrical service entry master panel, communications service entrance, etc. All these things can be put together in compact standardized form within a wall or two at a factory then delivered to the job site for EZ installation without subcontractors. The kitchen sink will share a wall with the bathroom shower/tub, toilet, and lavatory. Despite such standardization, there will still be a lot of leeway in selection and arrangement of fixtures, appliances, and decor. The connections made in a factory setting can meet higher quality standards. Saliiently, total labor hours as well as expensive subcontractor work at the job-site are much reduced.

An effect of the use of drop-in cores is to cluster all the utility service connections and entrances in one spot in the house – not the case in most onsite construction! Thus it makes sense to locate our KGB unit by the ‘street’ or ‘service alley’ entrance of the home, along which ever access corridor where ever the utility mains are laid. These constraints will still leave plenty of room for floor plan and home size variety.

We’ll have to do some rethinking, however, and this for several reasons. We can’t just apply existing works core layout and designs simply translating them to lunar-sourceable building materials. Our design requirements will be rather more demanding. For one, we’ll need a fresh air entrance and stale air exit. Lunan homes will be verdant with plants to help keep air fresh, but that should be seen as an a biological “assist” device for the fallback utility air circulation system.

For another, drainage from various sources will likely be segregated to make the water-recycling utility’s job no more difficult than it should have to be. Garden runoff, tub/shower drainage, kitchen sink effluent, and toilet wastes all pose different problems for treatment. Not mixing them will simplify the management task and isolate problem areas as they come up. [see MMM #40 NOV ‘90 pp. 4-5 “Cloacal vs. Tritreme Plumbing” and “Composting Toilets”.]

Those precursor drop in plumbing cores I’ve seen contain only Kitchen and Bath plumbing connections. We’ll want to integrate laundry connections as well. And a new standard feature of Lunan homes will be an inside garden with solar access (whether the residents choose to grow flowers and foliage, or vegetables and herbs, or just patio-side shrubbery is their choice). The Garden will need to be watered and drained.

Finally, we might as well integrate electrical and communications service entrances into the package. That’s a lot of stuff to integrate and it is going to take a lot of brain-storming to meet the design challenge with the most space efficient yet follow-on diversity-friendly layout options. To make the challenge even greater, consider that modules will not share walls, just interconnecting entrances. The resulting core package will be a more complex and extensive assembly than we see today in modular and manufactured housing. One suggestion is to pack all these “works” features into a modular entrance node by which all the other “bigger, dumber, cheaper” modular units of the house are reached. Something like a head-trunk “guts” module to which the arms/legs are attached.

The Lunan home must be designed as a functioning organism. It represents and serves as the personal, family-level extension of the settlement’s minibiosphere. If you stop and think about it, that’s quite a major shift in our philosophical understanding of what a home is. Just as extra-biospheric (trans-Earth) cities that have to host biospheres of their own will be need to be thoroughly reinvented (MMM’s “Xities” series, issues # 51-6), so too with settler homes within mini biospheres of which they be capillary-served living tissue.

Perhaps now the reader will begin to see why we did not begin our series on Lunan Homes with a piece on the architectural options and possibilities. The architect too must know what he is up against, within which design constraints he must work. Visual and Solar and Utility access demands are the course prerequisites for Lunar Architecture 101.

**MMM**



METE: MODULAR ELEMENT TESTBED ENSEMBLE  
**A For-Profit Project to Predevelop Architectural Subassembly Elements  
for On Site Construction.**

[mete (meet) n. def.: limiting mark, limit, boundary]

**Mete: v. to assign by measure, measure, allot; n. boundary**

By Peter Kokh

If the Visual and Solar and Utility Access–providing plug–in feature–packed subassemblies we have been talking about are to become standard in Lunan frontier home construction, it might be wise to begin the designing, testing, and debugging of prototype units here on Earth, while we are trading time waiting for CATS, cheap access to space, or BATS, budget access, and a more favorable economic climate.

These units can be made of terrestrial materials but for many critical function parts these materials may have to be reasonably close analogs of those we could expect to be available in the curtain–opening era of frontier settlement. In most cases, this requirement should not prove to be an insurmountable challenge. In others, we’ll just have to do the best we can with available materials pending development of better analogs (e.g. glass–glass composites or Glax™).

The purpose of the METE PROJECT is to test and compare alternative design approaches and assembly methods. The goals will be simplicity, durability, safety, and minimal failure modes. This is homework. No seating in the classroom without it being turned in complete. That the dog of apathy or buck–passing (“that’s NASA’s job”) ate it, won’t fly. Surely in the process we’ll discover marketable applications galore to Earthside housing. And this for–profit driver should be a big help in getting these design tasks done the “spin–up” way.

#### **Visual Access METEs**

Z–View window units withstand the pressure differential between interior habitat atmosphere and external vacuum. Can we use flat glass if we gradually step the pressure with intermediate panes? We can start with laminated safety glass, but ultimately we’ll want to test the pressure tolerance of panes of fiberglass–glass composite, the lunar–appropriate solution. Can we make larger windows using convex panes, curving in towards the viewer so as to be compression–stressed by the higher pressure. Glass is strengthened by compression, a fact already put to good use in deep–ocean submersibles. For a stronger assembly, less prone to racking, should we use round frames in a zigzag tubular shaft with elliptical diagonals?

How do we make the seals in a way that not only does the trick but so that the manufacturing and assembly process can be duplicated on the Moon and require the least mass of parts or materials expensively upported through Earth’s deep gravity well? What kind of coatings will we need to cut down glare and unwanted heat gain/loss? How simply can we design the mating of our factory–finished subassembly to the habitat module on the job site? How does our METE actually perform in a vacuum chamber?

Less expensive pressure testing might be achieved by placing the METE in a quarter–turned attitude under water so that the parts to be exposed to vacuum are exposed to surface air, and the habitat interior interface is at a depth which duplicates the expected pressure differential. High altitude balloon testing would be considerably more expensive.

Could not at least the footwork on these and other METE projects be channeled through design competitions between engineering and technical colleges? The prize(s) could be

put up by an entrepreneur who hopes to make a buck from any terrestrial applications. It's an approach worth trying.

### Solar Access METEs

Here we've uncovered a greater variety of distinctive options. Each of these options poses a quite different set of design, assembly, and onsite module integration challenges: Heliostat channeled broken path through a stepped pressurized shaft (akin to the Z-View), clustered fiber optic bundles, and solar hot water skylights or Sun Wells in which plumbing connections and major thermal management are involved.

But in each case we do have something relatively compact to design and test. There is no reason why these design and test, redesign and retest tasks can't be done on Earth. Nor is there any reason to think that these homework processes could not also yield profitable terrestrial applications to suitably reward someone for all the pre-frontier research and development required.

### Utility Access METEs

This more complex design challenge would probably be best tackled by a divide and conquer method. College level plumbing, air conditioning, electrical, and communications teams could work separately, periodically coming together under the direction of a systems integration team. Again, at least for the high end manufactured housing market, there should be some marketable applications.

Here too, pressurization elements are of the essence: joints, seals, and interfaces. In this and other aspects, there is ample room and need for the various METE teams to communicate and share insights and findings. Again, there should be marketable developments in this area as well.

### Other METE Projects

So much for now. Additional METE project opportunities will be uncovered in future articles in this series, in the area of various interior structure and utility systems needed to turn habitable housing shells into comfortable homes, offices, schools, shops, and factories.

So our goal in this 'Better Lunan Homes & Gardens' series is not just to illustrate and bring to life for the armchair reader some of the ways settlers might "settle in" on the Moon. Our hope is also to inspire and spur on the entrepreneurial "spin-up" ventures that can make some of us (why not you?) some money now.

For us the big plus is the frosting benefit of having the satisfaction that we have done something creative to help enable and accelerate the opening of the frontier. For such work will **help telescope the outpost-into-settlement transition into a much shorter major-money-saving time frame** than if we wait until CATS has put us on site before we begin scratching our heads. Any of you entrepreneurial free spirits out there who'd like to network in brainstorming business plans to get these lunar train cars on track, please do get in touch. 

MMM #75 - May 1994





## Lebensraum — Elbow Room in Lunar Settlement Homes

Personnel on short tours of duty can put up with spartan and ultra-compact quarters – for the duration – witness submariners! They know it is only for a while. But those who have come with the intention of not returning to Earth, perhaps ever, will quickly go stir crazy. They will need much more spacious “homes” in which to “unfold” their presence and feel truly at ease. How will lunar architecture satisfy this need? See below

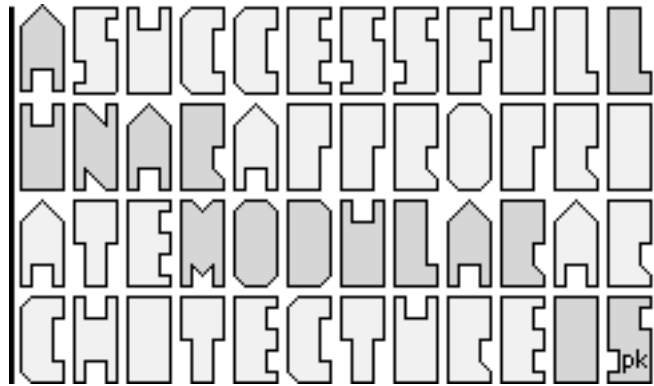

A SUCCESSFUL LUNAR APPROPRIATE MODULAR ARCHITECTURE: (is)

**One that incorporates these Six Elements:**

- **The smallest number of distinct elements**
- **The greatest layout design versatility**
- **The most diverse interior decorating options**
- **Fabricated with the least labor and equipment**
  - **Assembled with the least EVA and equipment**
  - **Pressurizable after the least total crew hours**

By Peter Kokh

### Relevant READINGS From Back Issues:

[Republished in MMM Classics #1] – MMM # 5 MAY '87 pp. 5-6. “Lunar Architecture”

[Republished in MMM Classics #2] – MMM # 20 NOV '88 pp. 5-6. “Ceramic City”

[Republished in MMM Classics #5] – MMM # 49 OCT '91 p.3. “Lowering the Threshold to Lunar Occupancy:

HOSTELS, Part II, 2) Roomloving functions”

[Republished in MMM Classics #6] – MMM # 53 MAR '92 pp. 5-6. “XITY PLANS, – II. Modular Versatility”

### Setting the Tone

If we (consortium, settlement authority, government – this applies universally) are not to be overwhelmed by the cost overruns that come from “stretch-outs” rooted in financial timidity and shallowness of commitment, the progression from Beachhead to Outpost (demonstrating startup processing and manufacturing technologies) to Settlement must move along swiftly. Once the level of confidence generated by the feasibility demonstrations reaches a critical point, the settlement must be prepared to grow quickly. Economic self-sufficiency only makes sense if it is achieved without delay.

We will need a way to provide roomy, safe and secure pressurized shelter, i.e. lunar housing, on a just-in-time basis as the waves of settlers pour in, ready to crew the industries that will supply income-earning exports to Earth. Residential units must be completed, utilities installed, with a minimum of crew hours. In contrast, interior decoration can be labor-intensive, pursued slowly over the years. But the habitable shell itself has to be erected 1-2-3.

Assembly line production of a few modular units that lend themselves to diversified floor plans seem to be the answer. The modules must be designed to connect simply and swiftly – yet securely. This is not Earth: the need to pressurize the whole against the external vacuum is a demanding one.

Speed is just one half of the coin. The other side is the need to hold the labor force involved in module production and on site home assembly to the minimum – so as many settlers as possible can work on production for export. Every part of the design of the manufacturing and construction processes involved must have this labor-light goal in mind.

#### **Materials suitable for manufacturing housing modules**

Steel and Aluminum or Titanium may come to mind. After all, that is how we build pressure hulls on Earth. But a reality check shows that while iron is abundant, processing out from the lunar regolith soils the various elements that we may want to use to produce iron's alloy, steel, is a bit problematic, especially since no one seems to be doing needed homework on this question. Yet a serviceable lunar steel alloy is much more of a near term prospect than is producing quality alloy aluminum – especially in the context of a small available labor pool, and the need to keep the mass of imported capital equipment to a minimum.

Another theoretical possibility (homework proceeding without due haste) is that of habitat module shells and components made of glass glass composites or Glax™. Concrete or Lunacrete is a possibility if economically recover-able lunar polar ice deposits are found. Fired ceramic shells and cast basalt shells have both been suggested, but unless reinforced with fiberglass or steel cables, they might not be up to the job of containing pressurized atmosphere. Our own wager, then, is with lunar steel and/or Glax.

#### **The Size of Lunar Homes – the “Great Home” Concept**

We must resolutely and brazenly set aside the notion that lunar settlers shall be forever condemned to endure life in cramped quarters. As long as pre-built shelter must be brought in from Earth, weight limits will work to keep pressurized space at a high premium. Fortunately, by the incorporation of inflatable elbowroom in early expansion phases especially for shared communal functions, “cabin fever” can be kept at bay.

But once simply and cheaply and easily manufactured housing modules have been designed that incorporate local lunar materials almost exclusively, valid reasons for pioneers to continue accepting constrictive personal quarters evaporate.

If it can be achieved within the labor and productivity budgets of the settlement, there is no reason why lunar settlers should not request and receive homes that are spacious by American standards. Indeed,

#### **There are good reasons to err in the opposite direction**

First, considering that lunar shelter must be overburdened with 2-4 meters of radiation-absorbing soil, and that vacuum surrounds the home, expansion at a later date will be considerably more expensive and difficult than routine expansion of terrestrial homes. Better to start with “all the house a family might ever need”, and grow into it slowly, than to start with initial needs and then add on repeatedly. Extra rooms can, of course, be blocked off so as not to be a dark empty presence. But they can also be rented out to individuals and others not yet ready for their own home, or waiting for one to be built.

Even more sensible is the suggestion that the extra space will come in handy for cottage industry in its early stages, before the new enterprise is established, matured, and doing enough business to be moved into quarters of its own. At the outset, with every available hand employed in export production, the demand for consumer goods, furnishings, occasional

wear, arts and crafts, etc. will have to be met in after-hours spare time at-home "cottage industry". The lunar "Great Home" could meet this need elegantly.

**"A Minimum # of Module Types"**

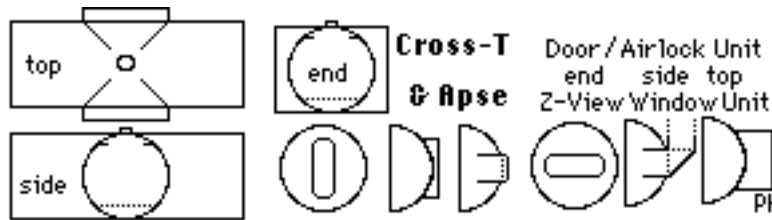

Above are shown 2 basic modules: a 4x12 m (= 13x40 ft) cylinder with open ends and expansion openings to each side. These units can be chain- or cross-linked, but ultimately, all remaining openings must be closed by an apse or hemispheric cap. Four versions are suggested: simple blind cap; cap with door (to the "street" or to an EVA airlock); cap with periscopic "picture window" unit, and cap with utility service entrances: fresh/drain water, fresh/waste air, electricity, telecommunications, etc.)

Our suggestion is that the water-using functions be concentrated in a cross-T module with a side utility entrance cap. Two phases are shown. But we recommend the whole complex be built together.

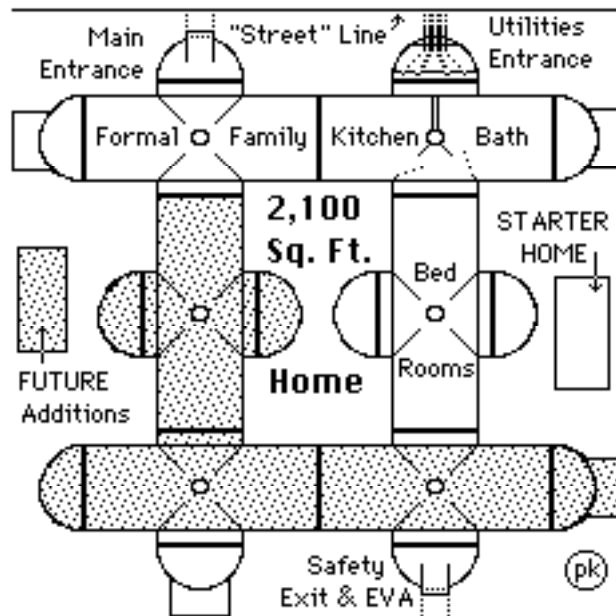

**Add a third, larger module and presto!**

As soon as the settlement's module manufacturing facilities are able to produce longer, larger diameter units capable of being configured into two floors, more spacious homes can be built with less modules on less land. At right is a "Great Home" plan that incorporates two of the larger 6x20 m (20x66 ft) modules. One has a master bedroom above and two or three smaller bedrooms below.

The other has no middle floor but is equipped with larger sun ports and houses a Garden-Solarium that quite literally brings the home to life, producing herbs, spices, and fruit and vegetable specialties for home use and possible sale. The unit includes a patio for nature-reviving rest and relaxation.

This spacious Great Home or Mare Manor includes ample space to pursue hobbies, even to start up a cottage industry. It is assembled all at one time.

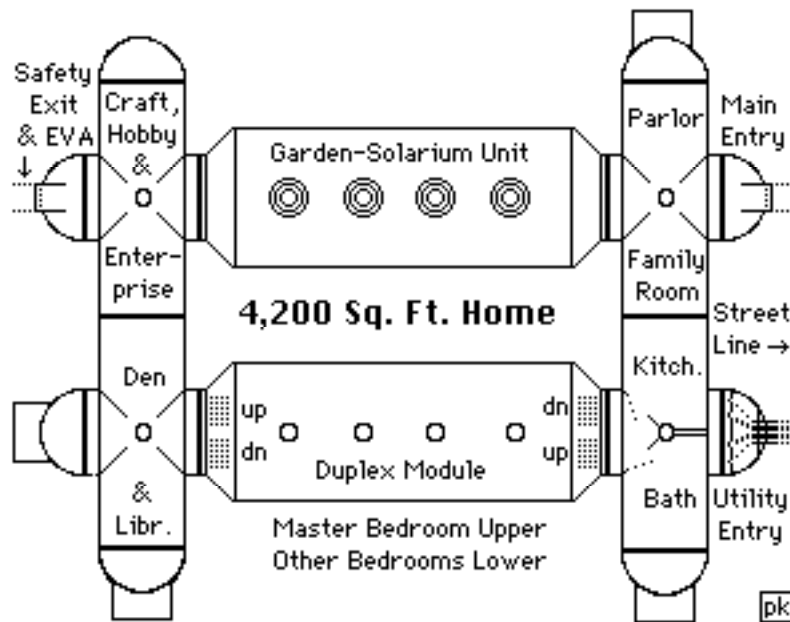

### The settlement will need more than homes

As it grows, there will also be a need for larger constructs to serve as apartment blocks, office complexes, schools, clusters of shops, and so on. One way to combine the three modules previously described in larger clusters is to provide a larger polygonal atrium module. We chose a 12 m (40 ft.) diameter octagon for our illustration, simply because our MacPaint drawing program doesn't do hexagonals well. Here we have an atrium floral and foliage garden with a peripheral portico balcony leading to the entrances of other single and double-floored cylindrical modules.

Other specialty connectors could introduce even more diversity in module layout options. Hex nodes, equilateral Y nodes, Y nodes with the fork separated by 90° instead of 120°, longer, and wider cylinders, torus segments etc. The result would be an ever more expressive homegrown architectural "language". Yet the 4 basic modules shown here should be able to put together a respectable town.

Not to be forgotten are the larger diameter cylinders with side ports of which the settlement's residential and business streets are made.

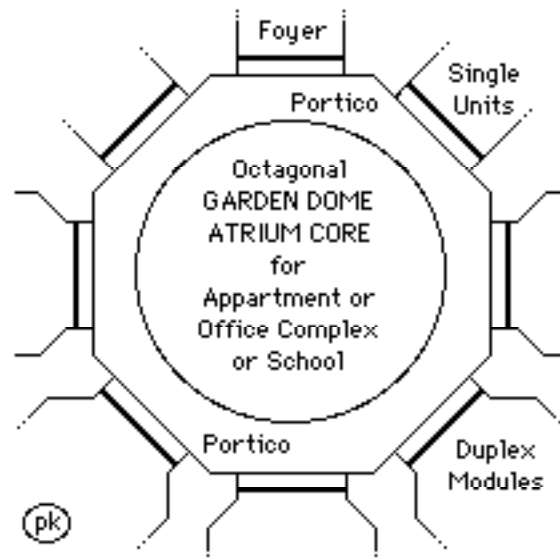

The search for the best modular architectural strategy, one that meets all the challenges listed at the outset of this article, will certainly benefit from being tackled by many minds. The sketches above are suggestions. Perhaps there are far better solutions than those which have occurred to me.

### The Apse or End Cap – Challenge or Opportunity

In comparison with terrestrial homes of what-ever style, the distinctive feature of homes on the Moon (or Mars) (that are not within an atmosphere containing megastructure) is their curves. The structural stresses imposed by pressurization and the need to minimize failure constrain basic shell choices to sphere, cylinder, and torus, and combinations of the above. Floors will be flat, of course, as will be added interior walls. But decorating and furnishing outer side walls that are curved will present challenges. The ways these challenges are met will contribute much to the distinctiveness of Lunar (and Martian) Homes. If you look again at the design offerings on the preceding page, you will notice that on average, the cross-T cylinder module, with 4 vectors for expansion, has other cylinders at 2 points, and apse end caps at the other two. These hemispheric alcoves seem to be everywhere.

Will the Lunan homemaker look at these odd-shaped spaces as nuisances, places to stuff odds and ends or stick something distractive? I rather suspect that instead a number of enterprises will arise that find a suite of ways in which to turn this layout liability into a real asset. While these end caps will probably be erected as empty shells – some of them with factory installed entrances or “Z-view” windows, others with factory installed utility service entry connections, others plain and “empty”. And as usual, those who come up with ways to productively fill such alcoves will find a ready market for their “product” among those less creative or imaginative. There is a market here, not for factory installed “built-ins”, but for post home-raising tailored “snug-ins” with a built-in look. This thoroughly standardized space is the perfect opportunity.

#### Some obvious solutions are:

- ✓ “Murphy- bed”-reminiscent fold down beds with night stands, lighting, etc. for a supplementary bedroom;
- ✓ non-hide-away version of same    ✓ closets and storage units;    ✓ audiovisual entertainment centers;
- ✓ dinning room buffets;    ✓ breakfast nooks;    ✓ kitchen cabinetry and pantries;
- ✓ library-den shelves and cabinets;    ✓ devotional center or chapel;    ✓ bathroom equipment;
- ✓ an exercise center; you get the idea.

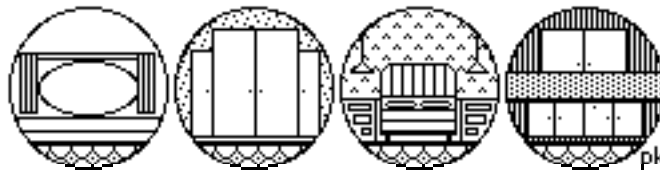

We have not yet talked about interior wall decor (next issue) or distinctive lunar-appropriate furniture and furnishings (later issues). But the architectural implications for lunar home interiors are already becoming obvious and interesting.

#### On the street where you live



Like terrestrial homes, lunar versions will have a certain front door/back door polarity. Here, however, the back door may be included less for convenience (handy to the kitchen and/or garage and/or kids' outdoor play area, as for safety – an alternate way out in case of emergency. Whether the back door leads to a pressurized “alley” or serviceway (that would be a convenient feature) or simply via an EVA airlock to the surface vacuum, is another question, one to be given careful consideration by the city planners long before the first home is erected. If there are such a pressurized serviceways, utility entry connections (air, water, power, data) can be located alleyside rather than 40 ft. from the “front door” on a single street as shown in the illustrations above.

While homeowners in general need not be concerned with the “external appearance” of their buried home [but see “Moon Roofs” in MMM # 55 MAY ‘92 p. 7] they will have the opportunity to do something distinctive with the areas of the street cylinder wall adjacent to the doorway to their homes. They can choose the anonymous unimproved look, or do something distinctive to the door itself, most likely in the way of approved appliqués, or the trim or “matting” around the door framing. For this purpose brick and tile and lunar rock (as is or cut and/or polished) are some of the obvious possibilities. And certainly some doorside landscaping as space permits, at least wall-hung potted plants. Entrepreneurial concerns will arise to meet the universal psychological need to signal personal uniqueness at the public entrance to one’s personal world.

PK

### MMM #76 - June 1994

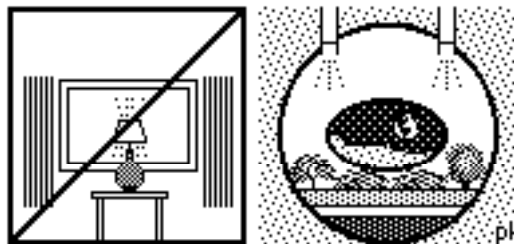

#### Windows - out with one cliché, and in with another

Driving along at night one sees home after home with a lamp on a table in front of the picture window? Poor decorating actually, but commonplace. On the Moon, with very little pedestrian or motor traffic “outside”, exterior “presentation” will rate low.

Ranking higher will be the need to gaze on the stark moonscape through the reassuring foreground of living foliage and flowers, under solar spotlights. More on lunar homestead interiors, below.

[Editor: the author of the series of pieces that follows has his own one man “This Old House” business and specializes in custom home interior remodeling and redecoration. His hands-on experience working with all sorts of building and construction materials and in getting the most out of them under oftentimes difficult conditions has filled him with enthusiasm for this “ultimate challenge” to home-crafting resourcefulness.]

INSIDE

# MOON MANOR

INSIDE MOON MANOR By Peter Kokh

In the previous issue we speculated a bit about the possibilities for a modular lunar-appropriate homestead architecture reliant on locally produced building materials. Until such a far off day arrives when new homes are built within atmosphere-retaining megastructure units, traditional box-type homes are ruled out. The need to contain atmosphere against a vacuum under a protective shielding overburden will result in homes with curvaceous exterior shells or "hulls": curved side walls and ceilings and cylinder end caps. Such shapes can be put together to yield a great variety of floor plans and layouts.

We learned that the alcove-like spaces of hemispheric cylinder end caps will be an opportunity for "snug-in" furniture with a built-in look. We saw too that these caps are the logical modular element by which both visual and personal access is provided, in alternative versions.

In this issue, we take a further peep inside the Lunan homestead. We'll look at the building materials likely to be available in the early settlement and their implications for interior decorating options. While Lunans will have less choices, with resourcefulness, a great deal of decorative variety should be possible, nonetheless. 

## Manufacturing and Assembly of



By Peter Kokh

So far, our speculative Lunan Homestead is just a shell, one continuous labyrinthian space. In a pinch, that'll do. Heck, we can string up a blanket or sheet to provide privacy where needed, but that is certainly no long term answer to the need for structured, subdivided space to house a variety of rather different activities. We will want interior partitions or walls and interior doors and doorways. These can, and will be added afterwards – after construction and pressurization and utility hookup, and after the new occupants take possession. For as we have seen, the need to provide safe basic shelter in as timely a fashion as possible will be paramount. All other "secondary" shelter needs will have a much lower priority, that is, no real urgency at all.

All the same, how will we provide partitioning? We won't be able to order a load of 2x4s and dry wall sheets. Even if the settlement farm can produce wood as a byproduct, the young biosphere can ill afford to see its carbon and hydrogen content withdrawn from quick turnaround circulation to be "banked" instead in so comparatively frivolous a pursuit.

If indeed economically recoverable lunar polar water-ice deposits are found, then gypsum, the hydrated calcium sulfate used in dry wall could be produced. To produce dry wall or sheet rock itself, we'd also need a substitute for the paper/cardboard surfaces used to sandwich the gypsum in sheets. Some sort of tight-weave fiberglass might do. This lunar dry wall could then be used with steel 2x4s now widely used in fireproof construction.

Baring this fortunate orbital prospecting find, and subsequent ground truth confirmation, the more likely building materials for walls are steel and aluminum panels, with steel easier to produce for the early settlement, and glass-glass composite (Glax™) panels, the same likely stuffs used in fabricating the homestead's modular shells themselves, making for consistency in decor treatment. Brick, sinter block, and glass block are likely to have limited



application where the permanent decorative look and feel they provide meet the original homesteaders' needs and desires.

Will available building materials be brought into the homestead from the warehouse with fabrication to take place on location with all the attendant dust, debris, and cut off waste? This may be the custom on Earth where the specifications of the particular job vary enormously. But for Lunan homesteads built of lunar-appropriate modular construction elements, the wall-spec variations will form a very limited set. Walls will either fit spherical cross-sections of cylinder modules or center or near-center rectangular sections along the length of the cylinder. In either case, they can be manufactured with in-factory efficiency for onsite snap-fit erection by again designing a very limited number of modular elements.

We suggest wall sections of a varying ceiling contour and height but with a standard 50 cm (19.77") width. A double clear space would provide a "rough opening" for a door 1 meter wide (i.e. 30.54", and why not 2 meters i.e. 79.08" high). If each module has a pair of retractable pegs or dowels on both bottom and top to fit matching holes pre-drilled into floor and ceiling on a 50 cm (half meter) grid, the modules could be put together to make a wall easily, and taken apart and reassembled elsewhere when desired.

The modular wall elements could be hollow or honey-combed, with or without inner acoustic insulation. Each of the various elements could be equipped with surface screw actuated KD ["knockdown"] connectors for easy mating. Surface screws would also actuate panel to floor and panel to ceiling pegs or dowels.

The various wall panel elements might also each be fitted with male-female electrical interconnects feeding one continuous service strip on each side of the wall panel.



If our suggestion for modular architecture were to be adopted, 3 principal "schedules" of wall module elements would do the trick: S(single floor module); DU(duplex cylinder upper floor); and DL (duplex cylinder lower floor). EMMM

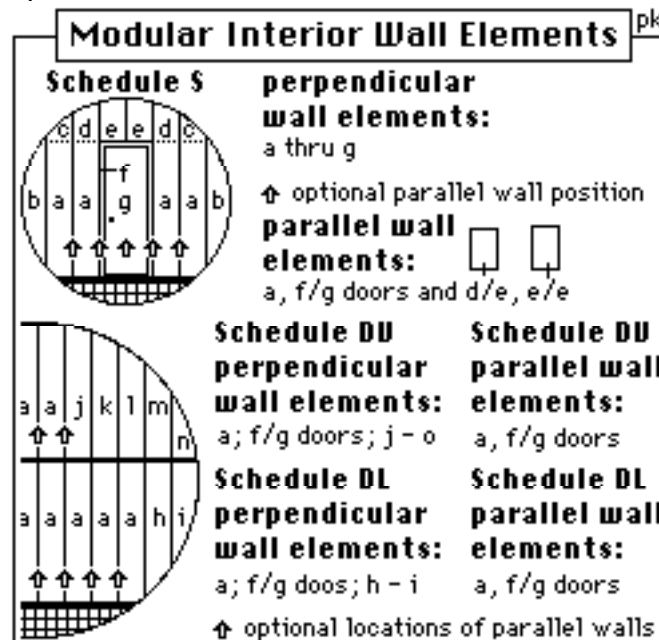



## SURFACES & TRIMWORK

### An Exercise in Resourcefulness — and Creativity

By Peter Kokh

#### Unavailable on the volatiles–impoverished Moon are:

**Woodwork** trim moldings                      Wood and wood byproduct **paneling**  
**Plastics** and hydrocarbon–based Synthetics **Wallpapers** and wall coverings of all sorts  
**Oil** (Alkyd) based **paints**, stains, varnishes    **Latex** (Acrylic) based **paints**, stains,  
varnishes

#### Still available for the resourceful homesteader are:

**Steel**, and **Aluminum**                      **Brick** and **cinder block**  
**Ceramic tile** – however, no lead–based deep colors and no lead–based high gloss  
glazes  
**Glass & Fiberglass–glass composites: Glax™**    **Pyrite** (FeS<sub>2</sub>) brass–colored surface  
coating of steel  
**Waterglass/oxide based\*** paints, stains, varnishes and “texture paints” with regolith  
pastes  
Titanium or lime (calcium) “whitewashes”

[\* NOTE: No known experiments to date but LRS–sponsored R&D to begin shortly, and to include application tools.]

#### And IF water ice is found in quantity at the poles:

**Concrete** (“lunacrete”, fiberglass reinforced, fiberglass surfaced cement board (Duroc™)  
**Plaster** or **drywall** (hydrated calcium Sulfate)

**The “ultimate resource” of any Settlement is the talent pool & creative resourcefulness of its people — not mere natural endowments.**

Background Readings in MMM’s Past [Republished in MMM Classics #7]

MMM # 63 March ‘93 pp. 4–11: Beneficiation; Sintered Iron; Alloys; Glax; Glass; Ceramics; Color the Moon.

MMM # 65 May ‘93 pp. 5–6. Sulfur; Moonwood

[NOTE: **A word about Prerequisites:** the discussion that follows assumes that the necessary homework has been done in learning how to isolate, under realistic lunar conditions, all the “workhorse elements” needed to make a useful stable of alloys, glass formulations, and colorants. See MMM # 63 reference above. Very little of this homework backlog has been done by NASA, by industry, or by capable individuals. It is MMM’s belief that much of the know–how needed on the lunar/asteroidal/space settlement frontier can be pioneered for profit here and now, solely for the terrestrial applications. All that is lacking are motivated and talented entrepreneurs.]

#### **Design Preferences: Simple Minimalism vs. Ornate Maximalism**

There has to be a balance in life. In Victorian times a century ago, when life and living were far simpler (or do we simply forget the problems of times gone by) home interiors were customarily ornate, excessively so by today’s standards. The wood furniture was highly carved, of complicated design, and often with marquetry inlay and other embellishment. Wallpapers and fabrics were “busy”. Things made of iron were full of curves and flourishes.

The Art Nouveau period that followed freed the curves from symmetry, replacing that sacred cow with free spirited “balance”, yet keeping all the curves in homage to nature. Art Deco came along and substituted the rectangle, triangle, and diamond – straight lines and hard angles in general, but keeping the new free spirit.

Then we languished in a state of eclectic poor taste for lack of inspiration. From this we were rescued by the simple straightforward “form is function” and “simplicity is elegance” of modern design. Many enduring different fountains of creativity here: Frank Lloyd Wright, the Bauhaus, Danish–Scandinavian design – to take a broad potshot at the spectrum.

Modernism installed a slavery of its own. Happily these days, we are each free to express ourselves as fits our own soul’s needs: with simple, graceful, minimalist elegance – or with wild, life-embracing detail – or anywhere in between.

When it comes to our picture of the future – and of space – the image of steel and plastic and plain lines has taken on a life of its own with no basis or justification at all in reality. In many frontier situations, plastics and synthetics will be prohibitively expensive exotic import materials. More to the point, the barren desolation of most, if not all, settlement settings in contrast to the lush host biosphere we all enjoy on Earth (even in the desert, even in the tundra) will stuff the pioneers with as much simplicity as they can bear, perhaps more. The deep psychological need will be for homes that are oases of rich detail and interest in this design desert.

Many of the suggestions for decoration illustrated below will strike the reader as being out of touch with today’s spirit. We protest that today’s spirit bears no relevance to the needs of the frontier. Frontier lives will be difficult, but hardly as over-structured and complicated as is common in our own contemporary situations. The one thing that will hold true for them as for us is that overriding cosmic need for balance.

#### **Variety in a small market**

What is needed is not only a number of different ways to decorate with interest, using few basic materials, but also ways in which to customize the effect. For manufactured items, computer assisted manufacturing or CAM offers promise. It has traditionally taken hours to effect setup changes in machinery to alter the product design or finish, and only premium cost or large demand justified the loss of productivity such change–overs required. Nowadays, smart machines can customize each item without missing a stroke. A small market and small total product run need not mean that only one kind of anything is made, that everyone’s wares and wears are indistinguishable.

At the same time, such “kaleidoscope machines” have limits. And the role of art- and craft-finished items will be important. Scarcely in history have artists and craftsmen enjoyed as much prestige as they will on the frontier. Never has the personal touch been as valued as it will be. To serve this need, some quantity of every item might be made “ready-to finish”. The trick is to design items that can be finished in an open variety of ways, either by the professional, or by the do-it-yourselfer working to his/her own satisfaction.

This will apply especially to furniture and furnishings. But we jump the gun and bring up the subject here because it applies to surface finishing in general. And living spaces as defined by floor, walls, and ceiling are an important instance.

The surfaces in question will include metal (steel, later also aluminum), glass, glass composite, ceramic, and cast basalt, and sintered regolith block — plus lunacrete or plaster or lunar dry wall only if water ice is found to be abundant.

Surface treatments: metal can be embossed, engraved, and oxidized (rusted) or pyrited (sulfur treated for the brassy yellow look of fool’s gold); it can be polished or sanded for a shine or satin sheen. It can be chrome-plated, or stainless.

Glass and glass composite can be stained and etched and mirrored. Cast basalt can perhaps be given the mold-transferred look of crosscut sawed wood, of bark, leaves, or other “nature collages”. Sintered regolith brick can perhaps be produced in pleasingly variegated grays with homogeneously colored regolith in waterglass serving as mortar. Tile can take on the

color of oxides, left unglazed or given a salt (sodium) glaze. Vitreous glazes without a lead-based flux are possible in many colors and hues, even if neither bright nor deep.

Surfaces with sufficient “tooth” or fine-scale roughness can perhaps be whitewashed with titanium oxide or calcium oxide (lime) powder suspended in a waterglass medium. Perhaps colored oxide pigment powders in the same medium can be used as paints. We see that there is plenty of room for experiment and the promise of amazing variety.

### Special wall and trim treatments

**Woodwork**, to which we are so accustomed in our homes the world over, is not a lunar-appropriate choice. While good “furniture quality” woods could be produced by apple and cherry orchard trees, the settlers will not be able to afford to withdraw and bank that much incorporated hydrogen and carbon from the biosphere-food production cycle.

One option is the “trimless look”, a natural for manufactured walls and wall module systems. For example, door and window frames are seamless features of the adjoining wall (modules) and not set off in color, texture, or any other visible way as “border” areas. I’ve seen such a look in Mexico City’s D’el Angel Hotel, and it is strikingly refreshing.

But where desired by the homesteader, the edging and border setoff function of woodwork, can be simulated by lunar-producible inorganic materials such as thin veneer (Z-)brick, ceramic tile, and metal “**trimwork**”.

These choices are illustrated below along with several possible companion wall surface treatments. As a general rule of good taste, when the chosen trim is ornate in feel, wall surface treatments should be simple; and vice versa.

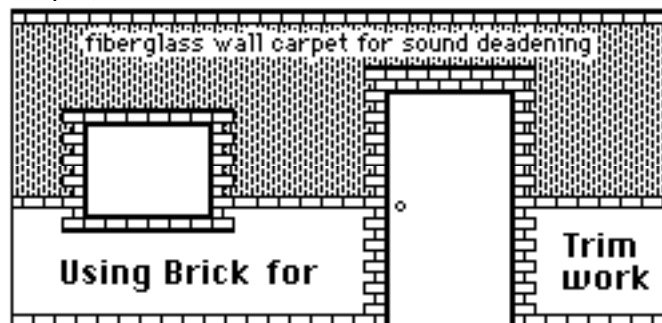

In the illustration above, the soft look of “carpet” is chosen to balance the rough look of the brick veneer. However, as organics and synthetics are not available for this purpose, and fiberglass carpet would wear poorly, being too brittle to take repeated crushing of the fibers, the latter is applied to the upper walls, out of harm’s way, so to speak, but still contributing to the sound control and providing visual softening.

In the illustration below, ceramic tiles are used to provide trim borders. While the seemingly endless variety in color, pattern, and glazing now available on Earth could not easily be produced on the Moon, a variety of hues from the lunar palette (regolith grays, oxide colors, stained glass colors) should be available either unglazed or in soft satin glazes. Tile in contrasting sizes, and coordinated colors and patterns, would make a good companion wall finish, as would simple white-wash or waterglass-based paint.

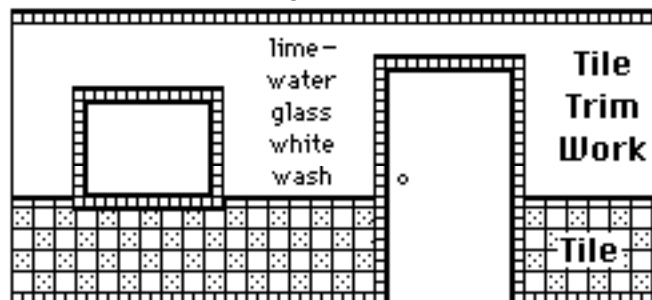

### Simulating the “wallpaper look” with lunar paints

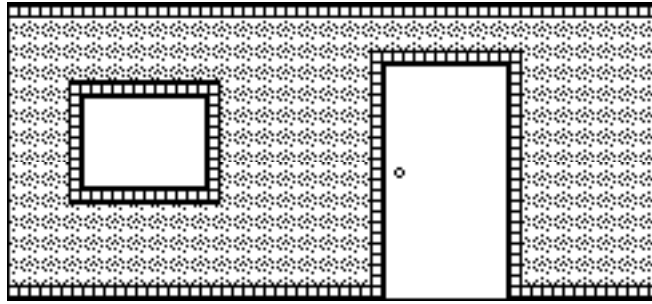

In this schema, the walls are first primed with a “whitewash” of lime in a waterglass solution. When this is dry, any of a wide variety of wallpaper like patterns can be sponge-painted over the base white, using metal oxides, again in a waterglass medium. Imported natural sponges of various textures and shapes can be used over and over again as the “paint” is water soluble. The technique is much faster than wallpapering and the results can be “painted over” when a change in color and/or pattern is desired.

Projecting a transparency of a scene or panorama to be transformed into a mural, one could follow the pattern with variously textured sponges dipped in various waterglass-metal oxide “paints” to create a result with an “impressionist” feel.

Other possibilities with waterglass-based coatings are in need of investigating. How about applying a clearcoat of waterglass and while it is still wet, random- or pattern-flocking with dry oxide powders or regolith powder? This could be done on site with by blowing through a hopper-fed (self-choking feed) straw equipped with variously shaped nozzles to alter the dispersion pattern (as in decorative cake-icing devices). Under factory conditions, flocked panels could be produced to order by computer controlled blower-printer. What would the effect be like? Has anyone yet tried anything of the sort? I suspect not.

### Metal “shakes” as a wall treatment choice

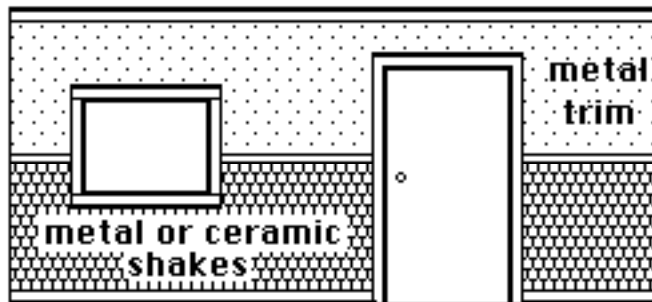

Using a repertoire of four differently edged shingles, each available in any of a repertoire of waterglass-oxide colors, a large-pixel mosaic tableau can be created. Working up from the floor, the metal shingles could snap into horizontal channels prepositioned on the wall, with a special topper strip. A computer could analyze a picture, pixelize the pattern and color codes, and list the elements to be purchased.

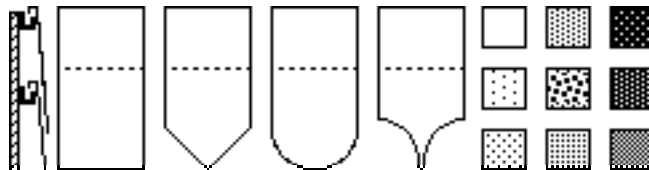

### Geometric and Pictorial Panels of Embossed or Beaten Aluminum “Sculpsheet”.

If Lunan metallurgists can formulate an alloy of steel or aluminum malleable enough to permit the kind of sheet working that has long been practiced in copper, brass, and tin, bas relief patterns or tableaux could be either mass produced in a number of popular styles, or

handcrafted on commission. The patterns or scenes might be “highlighted” by careful use of waterglass-oxide “varnish-stains”. This form of wall treatment might be an attractive choice for dens, libraries, formal dining rooms, entry ways, even for “front door” facings.

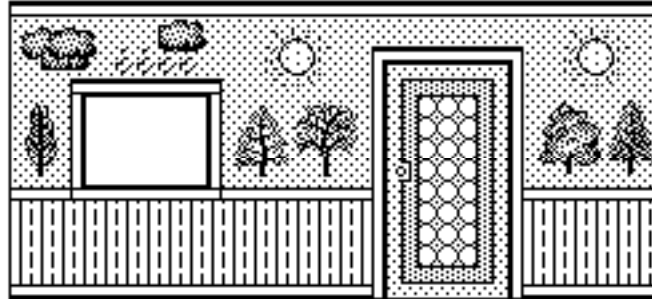

Less ornate and ambitious would be steel “paneling” of interlocking or tongue in groove narrow strips. These could all be finished alike or vary in a set sequence. Finishes that might be used include stainless with smooth, embossed, or satin-finish, chrome, and Pyrite surfaced steel. The latter, being of false gold, iron sulfide FeS<sub>2</sub>, would have a brassy-yellow finish. (Brass and copper are not lunar-available).

### Artist-Craftsman, Tradesman, & Do-It-Yourselfer

The settlement market should work to ensure the entrepreneurial supply of a number of satisfactory alternatives for three overlapping degrees of expertise, talent, and available effort. Within each there should be choices to fit various budgets. The result will be a surprising and spicy variety between individual personalized lunar homesteads.



### Special Wall Surfaces

**Tub surrounds, shower walls and sink back-splashes** can be glax one piece units, of standard size and shape and fitting interfaces, available in a variety of colors and patterns and textures, thanks to the ease of setup changes possible with computer-aided manufacturing methods. 

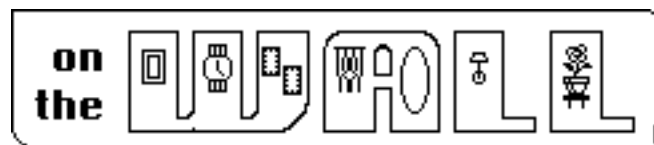

### Problems & Solutions for Hanging Stuff

ON THE WALLS By Peter Kokh

On Earth, it is no problem to hang something on the wall: pictures and paintings, macramé hangings, copper and wire sculpture, plastic bric-a-brac, mirrors, wall lamps and candle sconces, knickknack shelves, shelving systems, clocks, or whatever else is not too heavy and not too deep as opposed to high or wide. The reason it is not a problem is that the sundry wall stuffs we build with such as plaster, dry wall, and/or wood are all medium density materials. They are soft enough to pierce with a nail or screw, and firm enough to hold such

fasteners. Even concrete, brick, and cinder block – all denser and harder – have fastener systems designed for them that are more difficult, but not impossible to use.

On the Moon, the most probable wall materials are steel, aluminum, and glass-glass composite or Glax™. These are very dense materials, and while it is possible to drill holes into them, “repairing” the “damage” when one wants to redo a room and hang the same or other items elsewhere, exposing old wall-wounds in the process, is something else.

Cable-wrapped fiberglass reinforced lunar concrete is a remote possibility as a hull material. Some sort of cinder block is a conceivable but unlikely material for interior walls. For either of these, however, a waterglass-regolith mortar should be available in a wide range of gray shades. But as these wall materials are the less likely, let’s concentrate on the problems posed by metal and glax.

If repairing “nail holes” is the problem, the simple answer is not to make any in the first place. Yet our Lunan homesteaders will want to personalize their quarters not only by room surface decoration (paint, paper, panel, trim) but by hanging artcraft items and other objects “on” the wall. So we are faced with a design problem: how to design walls so that hanging things on them requires no added hardware, no added holes, etc.? We could limit ourselves to steel walls requiring only magnets. But let’s brainstorm a bit more thoroughly.

Our settlers will face two situations: (a) curved outer hull walls (either cylindrical or hemispheric concave surfaces); and (b) flat interior walls. Most likely the kind or at least the size and placement of things we will put on curved surfaces will show more restraint than the total freedom we are accustomed to enjoying with traditional flat walls.

On the horizontally concave outer walls of cylinder modules, only the central portion is suitable for holding things flat so that both top and bottom of the object ‘touch’ the wall.

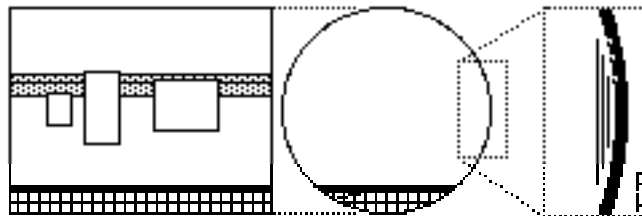

For this purpose, a series of built in hanging strip grooves is a solution that may work, and even presents decorative possibilities, i.e. as a broad horizontal stripe. Objects can be then hung anywhere along the length of the wall, utilizing the hanging groove that best suits their individual height. While the result may be that pictures and other objects are hung slightly below the customary “eye-level”, the hanging groove stripe, perhaps differentiated by texture and/or color from the rest of the wall, will be at the top of this range, serving as a visual corrective of sorts.

This hanging system can be repeated on flat interior walls, especially if one wants to continue the visual effect of the color/texture differentiated hanging stripe. If not, i.e. if one wants more freedom for flat interior walls, then the hanging “stripe” should be visually minimized by not distinguishing the space between the hanging grooves by texture and/or color.

Bearing in mind the suggestion that interior walls be modular, with sections 50 cm or 20” wide, then the butted edges can be “perforated” to allow hanging objects at any height along them.

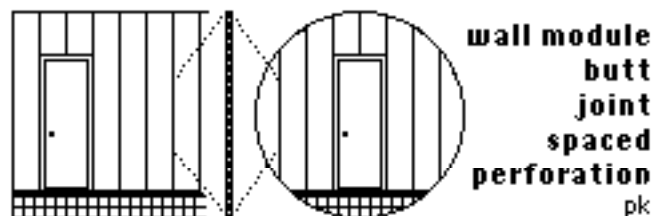



The constraint of having to space sundry hangings on 20 inch centers may be acceptable to some, not to others. An elegant alternative might be random perforation of the wall panels themselves. The result would not look like “pegboard” for two simple reasons: first, the hole spacing would not be in noticeably vertical and horizontal “rows”; second, the holes would be much smaller, say just large enough to admit a 6d (6 penny) nail, slanted downwards to a depth of say 1 cm or 1/2 inch. The effect, both visually and acoustically would not be unlike that of some acoustic ceiling tiles.



There is, of course, ample precedent for “nail hole control”. Many rental and lease agreements stipulate that the tenant or lessee must either repair any holes made, or use adhesive hanging methods – neither a practical option for our settler, given the wall materials likely to be in use. However, much earlier in the present century, it was common to place a “picture hanging molding” just below the ceiling. Anything hung “on” the walls could then be suspended by decorative cords, clips, and tassels from such a molding. That is a look long out of favor and not likely to find fresh converts. But it embodies the philosophy of built in “purchase points” for hanging various items “on” walls that we’ve tried to borrow.

Again, what we have tried to do is to illustrate the distinctive look of Lunan homesteads that is likely to flow from the constraints inherent in the building materials settlers are likely to have as options. With resourcefulness, such restrictions will trickle through to homes no less custom personalized, nor less beautiful than those left behind on Earth. While options will be less, the possibilities are varied enough that no one will be able to say, “when you’ve seen one Lunan homestead, you will have seen them all.” And in a world many magnitudes of order “smaller” in population, the pursuit of distinctive variety for its own sake will be intensely pursued.

A large part of our sense of world, is not just size, but wealth of diversity and variety – in scenery and terrain, in plant and animal life, in climate, and in architectural and interior decoration styles. With first just one, then a few more settlements and outposts on the Moon, the settlers will turn to variety in home decoration, not only as the spice of life, but as the principal way of validating their new adoptive satellite as a human world – one with depth.

MMMM



CEILINGS By Peter Kokh

How do you define “ceiling” in a habitat space in which the walls curve up overhead and over into one another without any break in the flow? If there is a cove well above eye-level to support ambient cove lighting, the area between the coves might be pragmatically defined as ceiling.

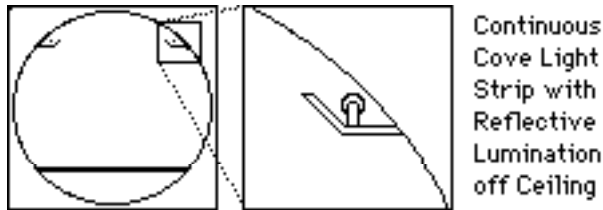

In some decorating schemes, dark ceilings have been used especially to visually “lower” them when the actual height is too high for one’s taste. Ceilings have also borne lavish decoration. The Sistine Chapel in the Vatican is the most famous example (the one in the Governor’s Conference Room in the State Capitol in Madison comes close enough). But recall also the molded tinplate panels that were commonplace in commercial halls at the turn of the Century (19th to 20th).

But overwhelmingly, ceilings have served as indoor surrogates for the sky, surfaces meant to reflect ambient light brightly. Accordingly they are traditionally painted in flat or other soft white or light pastel shades. On the Moon, we’ll probably see examples of both. The ornate design showpiece may be a high end budget choice as a focus of attention for meeting places, banquet halls, and just plain dining rooms.

But overwhelmingly here on the Moon where the outvac sky is black, the Earth-reminiscent overhead brightness of the sky will be repeated in homestead ceilings as repositories of soft rich unfocused reflected light. For this purpose a waterglass Ti<sub>2</sub>O (titania) and/or CaO (lime) whitewash should work. If a blue oxide pigment can be produced, we predict sky blue will quickly replace white as hue of choice. PAPA

# flooring<sup>pk</sup>

By Peter Kokh

In the context of the modular Lunan homestead, three subtopics of interest suggest themselves when it comes to floors and flooring. These are structure – how they are built and installed, function – what purpose these structures might serve besides providing surfaces to walk on and set furniture upon, and finish – what they might look like and feel like underfoot.

**Structure:** In sixteenthweight (1/6th G) truss members can be much less massive. We are talking about short 10–20 ft. (3–6 m) spans. Floors and truss/joists can be integral panelized elements, and in the case of two-story applications, incorporate ceiling surfaces as well. Since customer customizing does not seem to be in question, they might best be designed for more efficient factory-installation module by module prior to assembly of the separate homestead modules on site.

**Function:** if flooring is panelized or modular, ought it be removable? Removable decking could give access to storage space underneath as well as to utility runs (plumbing, ventilation, electrical, communications) connecting the various modules. Yet to the extent trouble free systems are involved, ready access looms as a less important requirement. Nor is subfloor storage especially convenient. More, it might interfere with some finishing options, e.g. installation of ceramic tile.

Fixed flooring could 1) serve most of the utility run needs 2) incorporate a radiant in-floor heating system, the most efficient and comfortable form of heating yet devised, 3) top off a thermal mass reservoir. The latter would be especially attractive if some lunar-sourceable form of eutectic salt can be discovered. [A eutectic salt is one that changes phase from liquid to

solid and back at a convenient temperature in the mid ambient range with a relatively large heat input/output i.e. storage/release.] To my knowledge of lunar resources, that is an unlikely prospect, however welcome it would be.

**Finish:** On Earth, popular flooring choices include carpeting, wood plank or parquet, vinyl tile or sheet (linoleum), slate, and ceramic tile. On the Moon, only the latter is a real possibility, along with steel, glass composite or Glax™, and tiles, bricks, or slabs of cast basalt.

Carpet can be made of natural or synthetic organic fibers. In either case, for lunar application, it would tie up priceless hydrogen, carbon, and possibly nitrogen that is best used to maintain and grow the biosphere. What about carpets made of fiberglass fibers? After all, fiberglass draperies are a common choice. The problem is that for all their strength, glass fibers are brittle and stand up poorly to wear, and other abrasive abuse. For draperies that is not a problem. Underfoot it would never work. However, glass fiber carpets could still be applied to walls, out of harms way, there to contribute to acoustic control and visual softening.

Cast basalt pavers are the one possibility mentioned that deserves the most homework. Baring that, ceramic tile and textured steel, pyrited for color, will be the workhorses. 

If carpeting is out, perhaps throw rugs made of discarded clothing are not – especially clothing made on Earth, gaining passage as the allowable maximum of settler recruit clothing, and produced through “nonkosher” processes that make recycling and/or bio-digesting of the constituent fibers difficult or “not worth the effort”. But is it not more likely that most recruits will head the request (if it is not indeed a requirement) to bring along only recyclable clothing? At any rate, in sixthweight, expensive resilient material is more efficiently invested shoe soles always in use, than in carpet that for the most part just lies there. 

## MMM #77 – July 1994

[Editor: one of the stints on the author’s resumé is that of former furniture salesman in the early 70s. His familiarity with furniture and home furnishings earlier and continued to broaden thereafter.]

### Inside Moon Manor Part II: Furniture and Furnishings

By Peter Kokh

In the previous issue, we took a look at “the look” of Lunan homestead interiors, insofar as they will be constrained by the materials to which settlers may well be limited.

In this issue, we take a further peep inside the Lunan homestead. We’ll look at the list of furniture-making materials likely to be available and how Lunan furniture designers might express themselves in such media. Then we’ll take a non-exhaustive look at furnishings or accessories. These articles will complete this MMM series on first generation Settlement Quarters. Related pieces will appear occasionally. 

Cinderella 

CINDERELLA STYLE

By Peter Kokh

It might seem that without wood and plastics, stuffs for furniture making available on the Lunar Frontier only at exorbitant cost, compensated by a corresponding reliance on such New Stone Age materials as metal alloys, ceramics, glass, and glass composites, that the “Style”, if any, achievable by Lunan furniture designers, will not much surpass those of the Golden Age of Bedrock way back in Flintstonian times.

That would hardly be a fair assessment. Mature style is less limited by the kinds of media on hand than by the artist/craftsman’s knowledge of the innate potentials of the materials and access to, and skill in using, appropriate tools. Even now, kindred materials are used on Earth to make sundry furniture items of premium quality, with a respectable market share.

But it is the absence of wood, organic and synthetic fiber, and plastics altogether as an option that will bring forth all the creative resourcefulness of the designer and craftsman in developing for the first time the full range of potential of the available materials. The results may be copied, or on the other hand anticipated, in the growing areas on Earth where wood is scarce, or more sorely needed for other purposes.

Combine this prospectus with the need to provide personal customized variety in what will for a long time be a very small market, and the challenge becomes stronger. One way to meet that challenge is to mass produce basic items in a simple functional design, “issue” (cf. G.I., government issue), that on the one hand has its own grace, and on the other lends itself to subsequent embellishment or elaboration, becoming a canvas, so to speak, for middlemen cottage industry artists and craftsmen, buying issue items wholesale and reselling them out of their homes or in streetside shops after they have been transformed under their skilled hands. Such items assuredly would be in great demand. Customers could buy “issue” items “factory-direct” for use as is, to give to a chosen artist for customizing on commission, or for do-it-yourself adornment.

Such an evolution of consumer product lines ought to merit real Frontier Government support. The brand new pioneer settlement culture, without access to the vast variety of manufactured goods available on Earth, will find in art/craft finishing of common ready to finish items an ideal way to provide the essential perk of custom individual variety. It is in the public interest to promote such development.

Once a “University of Luna” has been established, such art and craft activity aimed at making Lunan Homesteads more satisfying places in which to live, would appropriately become a major outreach concern aimed at full development of the widest possible range of Moon-appropriate art forms, materials, media, methods, and tools. Support for individual artists involved in this art/craft activity in collaboration with the University should extend only through the R&D phase. The market, expected to be quite vigorous, should be trusted to support mature expression in such newly developed Moon-appropriate forms.

What to make for furnishing the homestead from this burned out “cinder” of a moon? The “Cinderella Style” of the frontier will rise to the occasion. 

## MAKING FURNITURE For the Lunan Homestead

By Peter Kokh

Furniture is commonly divided into three broad categories:

- 1) “CASE GOODS” include items commonly made of wood: bedroom sets, dining room sets, living room tables, desks, bookcases, etageres etc.

- 2) "UPHOLSTERED GOODS" are just that: fabric-covered and cushioned chairs, love seats, and sofas. Modern bedding, mattresses and box springs, would fall into this category.
- 3) "ACCESSORIES" include lamps, pictures and other wall-hung items, table top sculptures, etc.

### Furniture Materials

Metals have long been used for case goods, but their market niche has been narrow: office and patio furniture principally. Glass has been used principally for table tops. Ceramics principally for lamp bases.

Glass composites, the sleeper, has not been developed at all as a furniture item (or for any other purpose) but has enormous potential in superior serviceability and performance, as well as in visual appeal (cf. our previously published suggestion in MMM #16 JUN '88 "Glass Glass Composites" [Republished in MMM Classics #2] that a formulation in which the glass fiber is colored or stained and then combed within a transparent glass matrix to provide a material with all the "grain character" of wood, be pioneered for the high end furniture market in order to pay the high initial development costs of this new material. Glax, to use the suggested generic trade name, may lend itself to the same fabrication techniques as current fiberglass reinforced plastics. This means it should be suitable for molded contour fitting seating, as well as for structural framework, replacing wood.

Below we offer a number of product "studies", trial balloon designs of "issue" items that can either stand as is or be further embellished, all according to customer taste. (Recall that in the last issue, we predicted a turn away from the elegant simplicity of modern and minimalist styles towards more design-intense items as a psychological counterweight to the monotonous barrenness of the lunar surface surroundings.)

### Cathedral Choir Style Box Chair, Love Seat, Sofa

In the illustration below, a glass composite molded seat and back, the actual "contact surface", is given an open supporting framework which can either stand alone or support encasing artcrafted panels of various types on the outfacing sides and back to provide a heavier, more design-intense piece. The variations shown do not correspond one for one with any specific possibilities, but are simply aimed at getting across the idea that an "Issue" item can serve as a "canvas" for further art and craft. The units could be ganged as modules to serve as love seats and sofas, either in look alike suites or in eclectic manifestations of the expertise of Lunan artists.

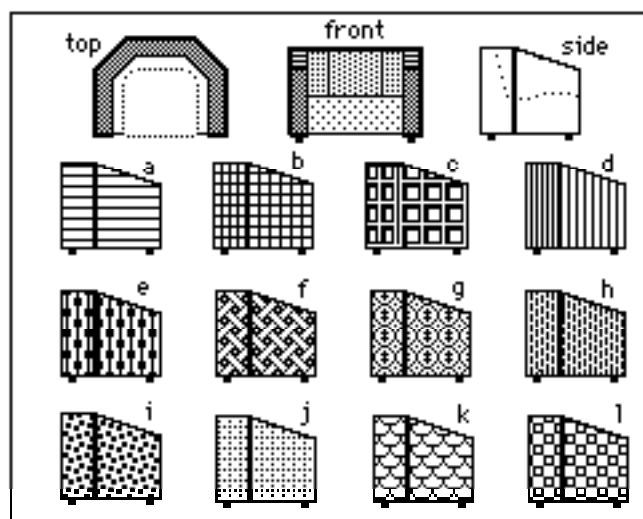

Among the many possibilities are:

- ◇ Aluminum panels embossed and/or engraved in abstract or pictorial patterns ("sculpsheet" alloy)

- ◇ Textured metal panels including pyrited (fool's gold) steel (brass or copper would be prohibitive)
  - ◇ Wire art
  - ◇ Wire weaves
  - ◇ Glass or ceramic beads strung on wires
  - ◇ Beads made from lunar rock
  - ◇ Macramé of fiberglass cords and ceramic and/or glass beads
  - ◇ Stained glass collages or murals
  - ◇ Glazed ceramic panels or tiles of varying sizes, colors and mosaic patterns
- Nb. If any of these seem "heavy", remember this is furniture for one sixth G or "sixthweight" and for the softer look
- ◇ Fiberglass fabric carpet
  - ◇ Fiberglass bands in multicolored scotch plaid weave
  - ◇ Fiberglass fabric pleated panels

The vast variation in final appearances made possible by such a menu of possibilities yet maintains the common underlying shape of the parent "issue" item. Eventually, entrepreneurs would find ways to customize the lines of the piece as well, starting with the addition of decorative finials, head rests, hand grips, and swing-out foot rests.

#### **Example: Chests and Dressers**

A chest of drawers could consist of metal or glax drawers with a frontpiece frame to fill with matched or coordi-nated drawer front panels of choice, all in a metal or glax framework whose sides, top, and edges are again opportunities for optional embellishment. Drawer pulls of metal, glass, and ceramic add another avenue for variety. If in time it becomes acceptable to withdraw small amounts of wood at a premium price from the biosphere cycle, usual roles may be reversed: expensive wood handles and pulls adorning metal or glax chests, not metal and ceramic handles and pulls adorning wood cabinetry. Perceived value will follow bottom line expense.

#### **Example: Bed Headboards**

Rectangular, Oval and other Headboard frames could support similar "panel" finishing. A large variety of choices exist. And of course, we could have bookcase headboards with built in drawers and doors just as easily as on Earth.



#### **Example: Lamp Shades**

Lamp bases can be of metal, glass, glax, ceramic, or some combination of the above. Glass, glax, and ceramic will offer the greatest opportunity for coloration. Design possibilities are virtually limitless.

For shades, translucent parchment and fabric materials other than fiberglass will be unavailable. Translucent, not transparent glass shades are a likely favorite. But so are pattern-pierced metal sheet, possibly also embossed. Following suite, one "issue" item may be a simple framework for supporting various slip-in diffusing panels. Stained and waterglass/oxide painted glass shades have ample precedent. Pleated fiberglass shades will be most reminiscent of current favorite options. Glass beadwork and wire creations are yet another possibility.

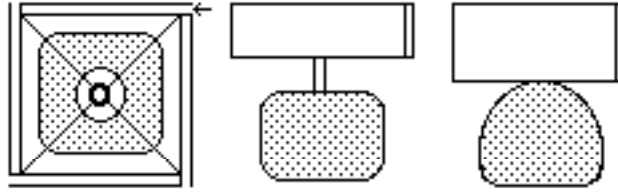

Above are overhead and side views of a schema for rectangular metal channel framework “shade starters” ready for slip-in panels of various materials, designs, and colors. There is no attempt here to predict style lines, only to get across how “issue” items can support the search for individuality and personal expression, as well as a thriving community of artists and craftsman entrepreneurs, all learning seemingly trivial but psychologically important ways to make the lunar setting a fully humanized one. MMM

**Sections of this Article Series omitted here:** [See MMM Classics #8]

**Upholstery Fabrics; Sculpture;**

**What to hang on the wall;**

**Art du Jour;**

**Homestead Furnishings and Decor as products of Cottage Industries**

## MMM #80 – November 1994

[Avoiding the “Sardine Can Syndrome”]

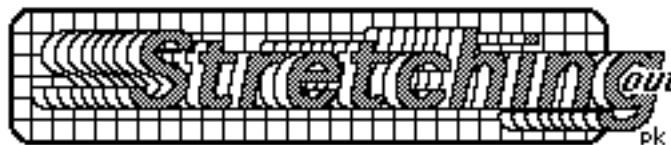

### **Usage, Layout, and Decorating tricks to create Psychological Elbow Room in Limited Habitat Volumes**

STRETCHING By Peter Kokh

This article is an expansive digest, if you will, of the spirited discussion involving panelists and audience at one of the LRS’ Science Track panels at the recent First Contact I Science/Science Fiction Convention in Milwaukee. The title of the panel was “Beyond the Sardine Can: ways to provide habitat space with real elbow room”.

We did eventually talk about bring-along inflatable structures and make-on-the-spot habitat expansion incorporating building materials made from local [Lunar, Martian, as the case may be] resources, that is, the possibilities on in situ construction and locally appropriate architectures. But as a prelude, we discussed how we might make the most out of a bad thing. Constraining payload bay dimensions, faring sizes, and payload weight restrictions all work to make compactness the virtue of excellence. This is why, for all the extra sophistication and increased capability, space stations now on the drawing board do not offer much more volume than Skylab of a generation ago.

For indeed, we need not put up with what can only be called poor design, layout, decorating, and usage patterns that unnecessarily suffocate those living and working in early era confined spaces. NASA in recent years has given some uneasy and self-inhibiting attention to “human factors” in adding to its endless series of paper studies of space station and Moon Base habitat designs. The concessions allowed in by the engineers who continue to hold the



whip over the architects may put off the onset of cabin fever by a day or two. They still have their priorities backwards.

Early commercial facilities will be affected by the same volume and weight constraints. But more attentive to employee/worker morale, they are likely to more motivated to draw from the wealth of human experience all about. Instead of grudging minor concessions, interior architects and designers of commercial facilities can borrow from a vast repertoire of tricks that humans on Earth living in cramped quarters have used to create substantial increases in psychological elbow room.

#### Usage Tricks

The first way to increase “spaciousness” is to cut in half, or even down to a third, the number of people likely to be in any area. We mean “time-sharing”. We mean a staggered two or three shift day-night work-recreation-sleep pattern. We mean getting around the clock usage from all spaces, from all equipment, getting our expensive money’s worth. Industry knows the trick well, some even cycling work week / weekend times.

Yes, NASA already has a 2-shift pattern in use aboard the Shuttle. But we can push this device further in a space or surface base. For example, if we can get beyond hot-racking in the sleeping quarters and provide individual berths, we can still time-share dead space elbow room between adjoining compartments occupied on different shifts. We can do this either with a movable partition or with separate doors to shared space.

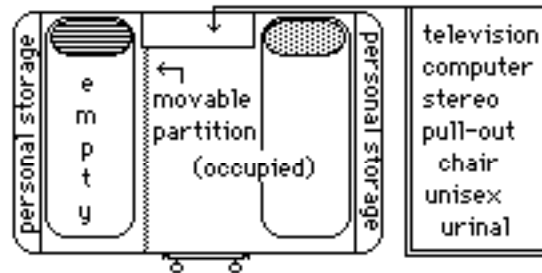

**ABOVE:** Time share dual compartment. The door has dual knobs and hinges. As occupying person leaves at end of 12 hr. sleep-relax shift, movable partition automatically shifts over and opposite door handle is enabled. Partition can be decorated to individual taste on both sides (colors, photos, paintings, etc.). Only the carpet color and works console is shared. Even here, each person calls up his/her own monitor screen design and his/her own hard disk. Here each person’s quarters are more than doubled in free volume, while the space of the compartment pair is increased by only half. The partition could be folded back by mutual agreement.

Of course, the principles illustrated above could be realized in any number of alternative designs and with either less generous or more ample shared common space. The point is that for a small investment in actual space, each person’s personal elbow room is increased greatly.

#### Layout Tricks

Have you ever seen a house, whose interior was very familiar to you, torn down, looked at the empty lot, and wondered how all that livability was supported in so small a footprint? Empty unstructured space seems small. Packed and structured space seems big. Counterintuitive, perhaps, but so.

Similarly, compare a quarter square mile subdivision with a rectangular street grid with one with an interesting combination of curving streets, and cul de sac circles. Layout can make a big difference in the perception of volume. Being able to take everything in at a glance with long unbroken sight lines affords momentary amazement and guarantees perpetual boredom in quick succession. That is as true of Space Station Freedom Lab Module Mockups as it is of O’Neill space settlement “sunflower” cylinders or Bernal spheres.

What is wanted in either case is to create the sense of a mini-world. But “world” is not a place you can see all of in one sweeping pan. “world” is a continuum of broken horizons, some

close, some far, only a small part of which is apparent at a time. In a “world” there is always “somewhere else” to go, places with different feelings and character. It’s a terrible mistake to give that up, either deliberately or out of inattentiveness. We all instinctively know that, the way our homes are built is eloquent testimony to it, but the lesson may never have risen to the level of specific awareness.

As it applies to habitat spaces, this lesson suggests two things: first modules should be combined in a variegated pattern. Angles of connection can be varied. The sequence of large and small modules can be varied. There should be both maze and easy interconnectedness.

Within a module, sight lines and trafficways should be broken. Open space should be more generous in commons and around work stations, less where the need to access wall panel storage, control boxes or service equipment is infrequent. In work areas, a lesson can be taken from modern offices created in large rooms. Each person’s workspace is sequestered by 6 ft. high movable partitions, often fabric-covered for sound insulation and personalizable with assorted hangings and plants.

In more confining space habitat/lab situations, individual work stations can still be mutually “baffled”. And since time-sharing will apply, there could be a general rule that the left-hand baffle surface belongs to one shift, for decorating purposes, the right hand surface to the other. This inexpensive feature, taking virtually no real otherwise usable space, will on the one hand work to control distraction and noise, on the other hand to boost ever so subtly the morale of the users.



Above (plan): a bank of un baffled work stations

Below: a bank of baffled, personalizable work stations

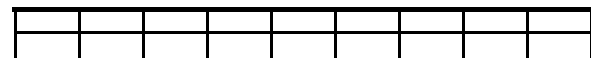

Breaking up long sight-line hall ways is important as well.

The engineer must defer to the architect. Below: An unimaginative layout. Even an engineer will die here.

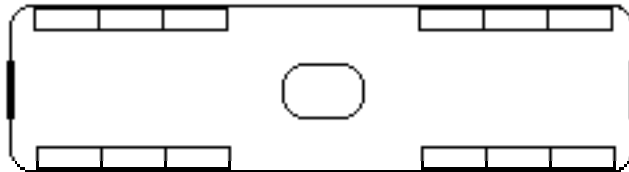

Below: an enormous improvement, yet same functions.



In the process of breaking up the layout, full attention must be given to acoustical control. Scattered zones of real relative quiet will increase the apparent internal spread of these mini-world volumes.

As important as the layout is the mix of spaces. People need places to get away from one another, and to meet in small groups as well as in an assembly of the whole. It is a mistake then to put all common space together. Granted each common space should have multiple uses to make sure that the space dedicated to it is used, and used as much as possible. All the same subdivision is possible. There should be “quiet” retreats (library/chapel) as well as lively spots (meals, lounge, games, meetings, films) equipped with a window to the outside.

**Decorating Tricks: color and light.**

Many things can work to subdivide, expand, and tie together spaces within spaces. Color is one. Color breaks that coincide with horizon breaks reinforce the individuality of the distinguished spaces. Ambient lighting should be used sparingly. Task lighting, by contrast, creates task-adequate individual pools of light, subdividing space without at all diminishing it.

If there is a bioregenerative life support system with food plants, this could be adjacent to the quiet area commons, especially if full-Sun over-illumination is used instead of diodes. Nothing is so soul-renewing as a Sun-strength light flood.

### **Decorating Tricks: murals and mirrors**

Habitat and Lab Module “walls” are likely to be jam-packed full with functionality. Work stations, service panels, storage lockers etc. Be that as it may, there is always some dead surface, even if it be door and drawer fronts, that can serve double duty as opportunities to enrich an otherwise Spartan decor. Color strips can run through door panels as well as dead wall. Mirror tiles are a possibility depending on location. Few things give such a subconscious sense of spaciousness, simply by relieving the eye, as a row of eye level mirrors.

In station mockups, two opposing surfaces are left blank to serve as visual ceilings and floors in the absence of gravitational ones. The faux “ceiling” could host a sky-mural, preferable on translucent panels over a running “light box”. A wall in the ward area or other commons places could likewise hold a backlit translucent mural: a forest or meadow scene, a waterfall and river scene; a seacoast scene; a mountain scene; an autumn scene, etc. These could be changed with the month or with the season.

All of these things apply to early Lunar and Martian outposts as well as to space stations, indeed much more so because the crew stay times are likely to be much longer and the need to counter boredom, cabin fever, and depression that much greater. In both cases, habitat space will have to be shielded. Whether this is in a trench, a tunnel, or above the general surface terrain, the effect is the same. Either way, care must be taken to bring both the view and the Sun down into the living areas.

In the case of the view, the barren Moonscapes and Marscapes, however awesome, must also soon become intimidating and threatening in their life-hostile sterility. Arraying a shelf of plants, foliage and/or flowers, in front of a window will serve as a subtly reassuring filter through which to appreciate the view in a more healthy and balanced perspective.

Where tours of duty are long, not only should the base’s pressurized space be “plexed”, so should the time spent therein. Time can be “plexed” in simple ways. Seasonal or periodic changes of decor, especially in common places will help. So will holidays, feasts, festivals, and other events-to look-forward-to. But variation in the indoor climate-control can also help. Why not a “refreshingly crisp” morning here and there? Why not “evening breezes”? Why not occasional mist-cleaning of the air for a post-rain freshness? Why not vary the strength of the air circulation in non-work areas? Time can be structured both over long and short durations to provide more natural, more spontaneous variety.

### **Looking ahead**

It will be some time after our return to the Moon before we can begin expending our lebensraum, our living space, with new modules built from materials made on site. This is so even if we do our homework and fully pioneer such materials beforehand using simulants and simulated situations. Meanwhile, with a little imagination, things can be made very much more livable with a little common sense. 



This month we turn to the Economic Considerations that will affect the viability of rural outposts. We begin with some speculation as to “appropriate” physical construction methods that might make “tarn-raising” more feasible.

**“TARN” ???: a Scandinavian word for a small, isolated mountain lake with no apparent inlet, but actually fed by rain or glacial melt-water;**

We have adopted the word as a metaphor for the **isolated “rural lunar” outpost that must religiously guard an initial water/hydrogen endowment, sources of loss make-up being costly.**

### **Background Readings from past issues of MMM**

[Republished in MMM Classics #1] – # 5 MAY '87 “LunARchitecture”

[Republished in MMM Classics #6] – # 50 NOV '91 pp. 6–8 “Hostel–Appropriate

Architectures”

# 53 MAR '92 pp. 4–6 “Xity Plans” – # 54 APR '92 pp. 5–6 “Xity Plans, Pt. II”

# 55 MAY '92 p. 7 “Moon Roofs”; p. 8 “Shantytown”

[Republished in MMM Classics #8] – # 75 MAY '94 pp. 4–6 “Modular

Architecture”



“TARNTECTURE” By Peter Kokh

### **Tarn Construction Materials and Methods**

If there is to be a “rural Luna”, especially inexpensive methods for constructing suitable pressurized volume from local resources must be developed. Equipment involved ought to be mobile, so that it can, construction or expansion finished, be transported to the “next” site on the waiting list.

Construction methods can be many and various. First, modular building plans seem especially appropriate. But if it becomes feasible to erect a larger common pressure shell which can be subdivided at leisure with individual structures that need only provide privacy and partition, that may prove a popular choice as well.

Fast & easy installation, cheap in both materials and equipment lease or rental, spacious with room to grow into, low-maintenance and energy conserving — these are the desired features for tarn structure and tarn-raising. Mobile casting units for hex-flanged upper and lower dome hemispheres is one suggestion. Fiberglass-reinforced cast basalt might be a cheap enough option. Glax (fiberglass-glass matrix composites) would be more expensive. Iron in the form of an inexpensive and easy to formulate steel would be another option. A SLuGS (Seattle Lunar Group Studies) investigation showed that in the regolith excavated from a lunar habitat construction site, there are enough free unoxidized ‘un-ored’ iron fine particles from which to build the structure needed.

Leased or rented equipment should be mobile enough to be moved from site to site without prohibitive expense. This can be done “overland” on truck beds, or by suborbital hopper, depending upon where the next site is located, and how accessible it is.

Initially, of course, the dependence on city- (main "urban" manufacturing settlements) produced construction equipment and building products will be total. But that era should be short-lived. Quite possibly, a town once built and occupied, may, in order to expand at less cost, and at its own scheduling, develop modular building components of its own. This technology could then be exported to other town sites, either by way of the necessary capital equipment, leased technology, or simply by shipping manufactured building components ready to use. Either way, entrepreneurialism in improved town construction methods, equipment, and materials, should provide one or more towns with extra diversified income.

Lego like (iron) tins to be filled with regolith (reminiscent of the "world bottle" plan which called for the design and manufacture of beverage bottles so shaped that they could be used as structural bricks), vibra-packed sinter-blocks, sulfur(-impregnated regolith) block (100 times less total energy of manufacture than concrete block), are some lower technology products that suggest themselves. Mining towns could use tailings to make building material products. Town building "kits" are likely to include equipment, molds, and forms for use with local materials, plus suggested plans.

We expect that in most towns, the accent and emphasis will be on the communal commons, on dormitories rather than traditional residences, and on the work place. This tilt would seem to favor the megastructure approach, though all of the above features can be achieved by the modular method as well. The African Kraal or Coral and the Southwest Indian Pueblo communities come to mind: translated, that would indicate a common shield wall and large commons or community square. Community life will be the strong suite of rural lunar outposts. Within the common structure, peripheral to communal space, would be residential dorms and or family or super-family quarters, work places, agricultural/horticultural areas, biosphere cycling equipment, and whatever else.

#### **Towns will be individually distinctive**

When you will have visited one town, will you have seen them all? Predictably not! Towns will differ from one another, first because their economic raison d'être will differ and be reflected both in the architecture and layout, and in the micro-culture of the place.

Second, **the very brashness of their attempt to survive and find a niche out in the lunar boondocks will assert itself by freely chosen arbitrary but highly visible architectural means.**

#### **Examples?**

3. Some, cherishing their isolation, may choose to blend into the moonscape unnoticed. But others may want to catch the attention of passersby!
4. How about distinctive, eye-catching, even gaudy entrance gates?
5. How about colored-fiberglass "thatching" over their regolith mounds,
6. Or simply a layer of colored powder?
7. Or some telltale horizon-breaking structure, preferably with a legitimate function, visible for miles around?
8. Think of windmills, silos, and grain elevators in the American countryside.
9. A gleaming "hydroshield dome" putting the town water reserves to use as light-filtering shielding over a park-like commons in a suitably sized craterlet? [ILLUSTRATION BELOW]

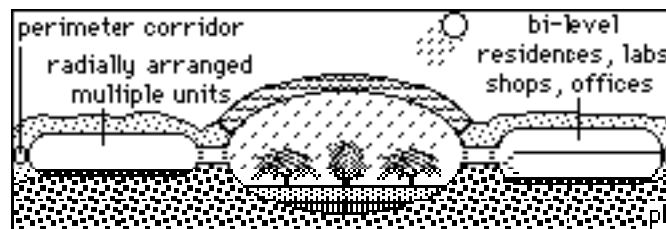

FIRMAMENT™ hydroshield domed-crater town commons with up to 24 'lithshielded cylindrical modules placed radially.

### **SOME PROBLEMS for hydroshield glass domes:**

- ✓ **Keeping water cool enough thru dayspan, warm enough thru nightspan:** known infrared rejection coatings may be insufficient. An active dayspan heat rejection and nightspan heating system may be needed. The hydroshield might possibly be used as a heat sink for industrial activities during nightspan kicking in as temperature cools. This would reverse more conventional operations scheduling.
- ✓ **Vulnerability to failure thru micrometeorite puncture of outer and possibly inner glass:** a nightspan sphincter shutter system might be required. This shutter could be withdrawn over polar facing sun-shaded portion during dayspan. It should be closable within minutes given radar warning of incoming meteorites of dangerous size. This shutter could also close during scheduled 9 hour “nights” during dayspan if a staggered shift system is not in use. (And a small tight-knit community is likely to reject any staggered shift scheduling option.) These measures would both decrease the vulnerability to impact accidents and reduce the total heat rejection burden.

### **Diversity of Niche = Diversity in Appearance**

Differences in appearance will flow not only from the choice of materials and construction methods. They will also flow from the tarn’s “vocation” and may be highly individual in character. There will be “family resemblances” also that advertise a group or class of tarns:

- **Roadside service tarns** belonging to some chain or franchise operation
- **Mining and processing tarns**
- Tarns that offer **retreats for city-folk**
- Tarns that conduct **special tourist excursions to scenic attractions** off the beaten path
- Tarns that take in and **educate students in boarding school academy settings** free of urban distractions
- Tarns that support **small science communities** e.g. at some giant lunar accelerator, or at a farside radio astronomy/ S.E.T.I. installation, or at a major exploration site above a complex of lavatubes, etc. e
- Tarns belonging to a **Lunan Farming Cooperative**
- Tarns belonging to some **religious or social denomination or movement** seeking to flower more fully well apart from the mainstream of Lunan society.

Each category will by nature express its functional and psychological needs differently. And these differences will often be quite visible sometimes from outside approaches, but sometimes only in internal layout and decor. Form follows function. Transport magically to the tarn square and you should have a pretty good idea right away what sort of tarn you suddenly find yourself in. That spicy variety will make “Rural Luna” a “world” worth exploring. For those who cannot afford to visit them in person, there will be the fascinating articles and pictures in National Selenographic. MMMM

[Various types of “Tarns” are discussed in MMM #85 May 1995 and #86 June 1995:  
Wayside tarns, Farming Tarns, Mining Tarns, Science Tarns, Recluse Tarns,]

**MMM #89 – October 1995**



## “Digging in” for safe longer stays

SHELTER ON THE MOON: By Peter Kokh

### Relevant Readings from Back Issues of MMM

[Republished in MMM Classics #1] – MMM # 1 DEC ‘86, p 2, “M is for Mole” – MMM # 5 MAY ‘87, “Weather”

[Republished in MMM Classics #3] – MMM # 25 MAY ‘89, p 4, “Lava Tubes”

[Republished in MMM Classics #4] – MMM # 37 JUL ‘90, p 3, “Ramadas”

[Republished in MMM Classics #6] – MMM # 55 MAY ‘92, p 7, “Moon Roofs”

### Other Readings:

“**Lunar Base Design**” by Peter Land, Illinois Institute of Technology, College of Architecture, Chicago, in “Lunar Bases and Space Activities of the 21st Century” pp. 363–73, Ed. Wendel Mendell, Lunar and Planetary Institute, Houston 1984, ISBN 0–942862–02–3

If an Apollo LM [pronounced Lehm] had remained on the Moon, it could not serve as the nucleus for a true lunar outpost. Its thin armor protected from vacuum only, useless against threats potentially just as fatal over the long term. A second much thicker layer of “firmament” is needed.

If human crews are to make extended stays on the Moon, they have the choice of being cavalier about the dangers and flippantly heroic. Or they can make sure their outpost is a true shelter and place of refuge from those characteristic lunar conditions that would inexorably work to do them in:

- 1.the big temperature swings between dayspan and sunlight, nightspan and shadow – thermal management in general.
- 2.cosmic rays incoming from all skyward directions
- 3.occasional solar flare storms with their intense radiation
- 4.solar ultraviolet, raw and unmitigated, during dayspan
- 5.the incessant micrometeorite “rain”

They can do this by covering their habitat complex with 2–4 meters (yards) of loose regolith soil. The amount or depth of desired cover depends on the longest crews are likely to stay during the lifetime of the outpost. Two meters will do for short durations of a few months. Four meters is better if you might stay the rest of your life.

### Direct Shielding Methods

The first real question, at which not nearly enough discussion has been directed, is whether to apply the shielding directly, or indirectly. That is, do we just use a drag line or bulldozer to cover the habitat complex itself? Or do we build some sort of hanger shed, cover that with moondust, and park our outpost modules underneath. Both have pros and cons.

The direct method is undoubtedly easiest and the most simple, requiring only soil moving equipment which will be needed in any case. If you want to keep the costs and weight of the first return mission down, you might consider this method.



It does have drawbacks! How do you add on later to an already buried complex? Leave the expansion end uncovered? One way, proposed by the University of Houston's Sasakawa International Center for Space Architecture, would be to first fill "sandbags" presumably brought along from Earth, with lunar soil, and then stack these around and over the complex. When you need to uncover a section for maintenance or expansion purposes, you just remove the bags in that area and replace them later. An elegant solution.

There is a cost, of course: (a) the bagging equipment, (b) the extra weight of the bags themselves. Eventually such bags might be woven locally of lunar fiberglass – would bringing along the equipment to do all that be more of an expense than just bringing along ready made bags? If you would break even the next time, or the third time, you brought up an expansion module, would that be worth it? That's a question worth looking into. Certainly, we must always look beyond the needs of the mission of the moment!

But there are other disadvantages of direct shielding, in any form. These are not clear, however, until we look into indirect shielding and learn what fringe benefits it allows.

#### **ORPHANED HOMEWORK:**

- (1) a (student?) engineering design competition to flush out the most elegant ways to cover a complex with regolith soil, with the lightest weight equipment, allowing one lunar dayspan (14.75 days) to get the job done.
- (2) Design sturdy, durable, closable, yet lightweight bags that can be brought to the Moon in a compact form.  
[as of 2012, we now think that such "sand bags" can be manufactured on the Moon of basalt fibers, an established terrestrial industry, rather than of fiberglass, as suggested below.]
- (3) Design equipment to weave lunar fiberglass threads into serviceable and closable bags that will hold the fine powdery soil. (Automated equipment to produce glass fibers and glass composite mats has already been brainstormed by Space Studies Institute, Goldsworthy Alcoa, and McDonnell Douglas. The equipment needed would weigh several tons, but pay for itself, in import tonnage defrayed, rather quickly.)

#### **Indirect Shielding Methods — SHED / HANGAR**

Building a dust-shielded "hangar" that provides large unstructured "lee vacuum" space in which pressurized modules can be "parked" in various forms of juxtaposition and interconnection, offers a much faster, and easier way to set up an open-ended expanding modular outpost. There is no shielding to remove when adding additional modules, nor any directly applied shielding to interfere with servicing and repair of systems with components on the exterior of modules or nodes.

As a bonus, there is extra radiation-free, UV-free, micrometeorite-free, and flare-proof unpressurized "lee" "service" space for storing tankage and other routinely needed, frequently tended equipment that does not need to be exposed to the sky. This in turn allows the wearing of lighter weight pressure suits for these kinds of "exterior" housekeeping chores.

The hangar shed makes sense if there is firm, review-proof **commitment to phased expansion** of the base beyond the original bare minimum habitat structure. For while its construction adds an original base-deployment "delaying" mission or two, the time- and effort-saving dividends down the road are considerable. If our commitment is scaled back to putting a toe in the water, rather than to a wholesale plunge, then, of course, the hangar will be seen as unnecessary.

A hangar can be built in many ways. A **pole and "canvas" tent** structure can be covered with loose regolith. Alternately, an arched space frame structure can be built, covered with a fabric, then overfilled. A less dead-end, more pregnant approach, at least with a view towards incipient lunar industrialization, would be afforded by bringing along molds and a solar concentrator to make sintered **arch component blocks** out of regolith soil. These could be stacked over an inflatable semi-cylindrical bag. With the completion of an arch section, the bag "slip-form" would be partially deflated, enough to move it over a bit, reinflate it, and support

the building of the next arch section. In this way, a little bit of equipment from Earth would allow indefinite expansion of lee space shelter using lunar resources entirely.

This slip-form sintered arch-block approach is well-developed in the paper "Lunar Base Design" by Peter Land of the Illinois Institute of Technology, pages 363-73, in "Lunar Bases and Space Activities of the 21st Century", Ed. W.W. Mendel, Lunar and Planetary Institute, Houston, 1984.

The 'ground' under the arch (the floor of the hangar) can be graded smooth, compacted and sintered to provide a relatively dust-free apron for the sheltered outpost. As we will see in a later article, "site management", dust control, and good housekeeping habits must be in place from the gitgo if our attempt to establish an interface beachhead is not to fall flat on its face. (Inner and Outer "Yard" Managers or yardmasters will be critical job slots.) The hangar approach favors the early adoption and rigorous pursuit of good homesteading habits.

The hangar interior can be **naturally lit**, during dayspan, by providing intermittent broken-path sun-wells or direct path "sundowns" made of bundled optic fibers which double as shielding. Electric lighting for nightspan can be separately suspended from the ceiling or placed above the exterior surface, to use the in-place sun-well or sun-dow light delivery system.

**Visual access** can be accommodated by broken-path (radiation-protected) mirrored shafts from the habitat modules underneath through the hangar roof. With proper planning, such ready-access observation ports can be provided ahead of time as the hangar is expanded section by section. Alternately, a pressurized vertical ladder-shaft can lead from habitat below to pressurized observation dome on the hangar roof.

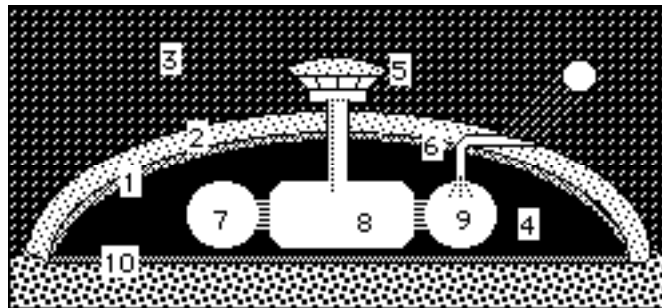

- KEY: (1) Space Frame Arch, Fabric Cover; (2) 20 cm or more regolith dust shielding; (3) exposed vacuum, radiation, micro-meteorites, UV, solar flares; (4) protected lee vacuum service area; (5) observation cupola with ladder shaft to habitat space below (7, 8, 9); (6) broken-path solar access via heliostat and fresnel lens diffuser; (10) compacted, sintered hangar apron

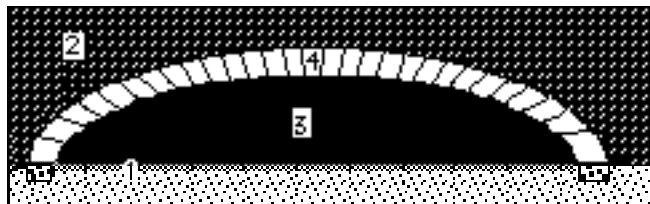

#### Arch-Block Hangar

- KEY: (1) compacted, sintered hangar apron; (2) "Weather"-Exposed Vacuum; (3) Shielded "Lee" vacuum; (4) self supporting arch made of blocks produced from sintered regolith in simple single shape mold, applied over an Inflatable Slip Form.

Hangars can be open for expansion at just one end or at both ends. The latter ploy makes more sense and provides greater expansion-vector flexibility.

The hangar approach can be called the twin or **Two Firmament Strategy**. Sheltering from exposure to the “weather” of the naked lunar skies is handled separately from sheltering from vacuum. An initial “umbrella” firmament is built first and allows a wide range of architectural freedom and plan revision for subsequent base expansion underneath.

In contrast, indirectly shielding individual habitat structures can be called the single, or more aptly, the Joint or Laminated Firmament approach. As usual, impatience quickly proves to have resulted in an unfortunate, option-preempting choice. The Two Firmament approach better embodies the philosophy of the base serving as an “interface” between Moon and Man.

### **Implications for Lunar Industry**

By this scenario, lunar sinter block and possibly cast-basalt paving slabs, not oxygen production, become the first lunar industries. (Using lasers or microwaves to fuse soil might be another option.) If a space frame approach is used, the manufacture of sintered iron rods and/or of glass composite rods and fabrics would become early industries. The pros and cons of both approaches have to be weighed.

### **Hangar alternatives**

If there is no firm commitment to phased expansion, but merely a concession to “leaving the door open” to further expansion, a half-measure would be to directly shield a habitat structure with an attached side or front “carport”/service area. This approach provides the benefits of attached lee vacuum. As to future expansion, the docking port for parking an added module can be included under the carport or under a separate shielding “retaining collar”. Obviously, this is a “consolation prize” approach and not the way we should be planning.

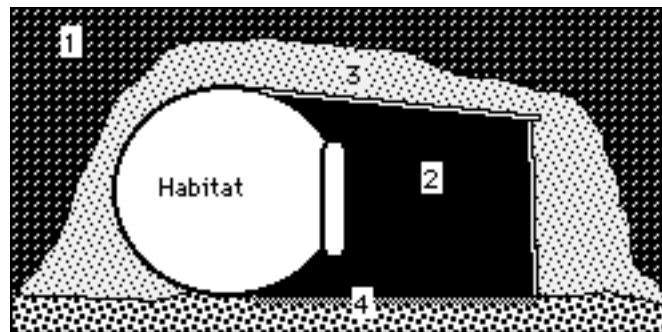

### **Directly Shielded Habitat with Carport/Service Area Shed:**

**KEY:** (1) Exposed Vacuum; (2) Sheltered Vacuum of Carport;  
(3) regolith blanket 2–4 meters thick

(4) compacted and sintered floor of carport, part of dust-control strategy.

At the other end, much more ambitious than the hangar, is to place the outpost in a pre-located lavatube. This may involve major up front costs of bringing along boring equipment for elevator shafts, and personnel/freight elevators themselves. Lavatubes have great promise, but they seem dauntingly challenging for an initial beachhead establishment venture, posing problems of easy access, floor rubble clearance, and possibly ceiling reinforcement.

In all this discussion, NASA preparation earns a C grade. Johnson SC has looked into both bagged shielding and inflatable structures. And through its space architecture university support programs has furthered studies of lavatube utilization. But much more needs to be done to isolate and identify the most promising alternatives for hangar architecture, weighing heavily those methods that give the biggest and earliest boost to lunar industrialization and use of local resources for further expansion.

NSS could apply some remedial assistance with a sequel to its '99-'89 Space Habitat Design Competition. The design constraints and objectives would have to be clearly defined, looking for maximum use of local materials, minimum need for one-use only import materials, low weight import capital equipment, and adaptability to automated or teleconstruction

methods. We'd need a donor/donors of prize incentives sufficient to attract suitable talent. And follow up publication of results (not like last time!). 

Apollo left no occupiable structure on the Moon.  
There is no 'friendly' place to return to,  
No place where we can go and pick up where we left off.

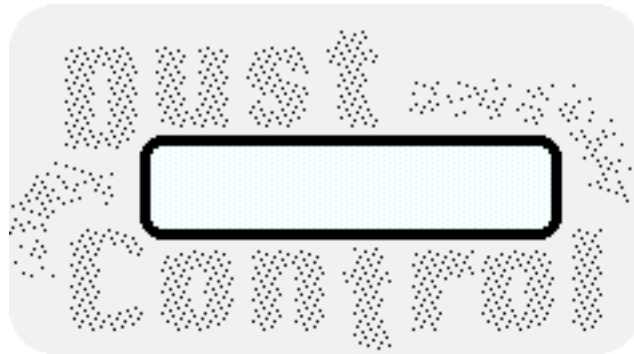

## Not all the physical aspects of the Lunar Environment that can fatally threaten a Human Outpost are "Sky-borne"

By Peter Kokh

### The problem with moon dust

The evidence from our six limited Apollo Mission engagements on the surface of the Moon is clear enough to be worrisome. Fine moon dust particles clung to spacesuits and tools and samples electrostatically, resisting brushing off. They found their way into all crooks and crannies of the lunar modules, even into the Apollo Command Modules into which the returning astronauts, their tools and samples, transferred.

These particles are "unweathered" and thus have sharp edges. They include an abundance of micrometeorite-produced glass spherules. There is good reason to believe that without aggressive countermeasures and "prophylactic strategies", they will accumulate in pressurized interiors to the point they foul up machinery, computer keyboards and mice, control panels and more. Some fear that inhaled moon dust could lead eventually, in extreme cases, to a sort of silicosis in the lungs.

Clearly, this is a potential problem of such scope that we cannot afford to treat it casually. It won't just go away. On the other hand, past human experience with sundry troublesome aspects of newly settled territories shows that most such problems soon become minor. We learn ways to deal with the problem that become second nature. In due course, bad effects diminish to the point where they are below the threshold of everyday concern. It becomes a matter of special habits – habits, if you will, of good housekeeping and good "hygiene".

Moon dust, as a problem feature, would seem to be susceptible to a two-pronged approach: proper design of the **structures** and the **equipment** by which we interface directly with the host lunar environment. We must brainstorm our strategies well in advance of our return, adopting a broad spectrum of promising tactics in the design, deployment, operation, and maintenance of our outpost from the outset – or risk an ignominious, dishonorable surrender. **Dust Control Strategy** must be part of Moon Base Design – and not in some token squeak-greasing afterthought manner.

### Architectural Countermeasures

In the previous article, we saw that grading, compacting, and sintering the near surroundings of our outpost structures is cheap insurance. Not only airlock and dock entries areas are kept relatively dustless but also the yard space where frequently accessed equipment, stores, and systems are housed. This suggests itself naturally in the erection of hangar sheds, but is a less obvious consideration, temptingly forgotten, in the direct deployment of individually shielded habitat modules.

Sinter-paved areas should be separated from untamed dust areas by access over grate-covered dust-moat trenches. The idea is to put the shoe- (and tire-) cleaning welcome mat as far out from the actual outpost entrances as possible.

Site Management must consist of more than “fixing” the regolith in entry apron and service areas immediately surrounding the outpost. Every regularly trodden and driven approach should be sinter-paved, by a method appropriate to the weight loads that will bear upon it. Pockets and preserves of natural moonscape terrain should be left for the areas and spaces between such paths. This will be a matter of landscape architecture and design in consultation with the Inner and Outer Yardmasters, to meet their needs. Ignore or dismiss all this and we will surely repeat the cluttered unkempt chaos surrounding McMurdo Sound in Antarctica, exposed by Greenpeace to our national shame and embarrassment.

There are limits to the effectiveness of such tactics. But without such dust containment zoning measures in place, anything else we try will not work at all.

#### **Engineering Countermeasures – Suit-Locks**

**The presently conceived airlock, and the spacesuit types now on the shelf, have no place in any serious effort to make ourselves at home on the Moon.**

Ben Bova, in his 1987 slow-selling “Welcome to Moonbase”\*, describes a “car-wash” type airlock in which incoming dust-laden astronauts pass through an “electrostatic shower” before entering the habitat proper. This would be an expensive piece of equipment, adding appreciably to the cost of lunar operations and settlement, if, as seems likely, it would have to be installed in each and every airlock!

[\* Ballantine Books, New York, ISBN 0-345-32859-0, \$9.95]

Pat Rawlings who did the illustrations for the book has elsewhere illustrated a much better dust-control approach. The cover of “Lunar Bases and Space Activities of the 21st Century”\*\* shows personnel wearing what I have come to call the “Turtleback” suit, in which an oval hardshell backpack covers the torso and back of helmet. This backpack is hinged on one side, and entry to the suit is made through the opening.

[\*\* W.W. Mendell, Editor; Lunar and Planetary Institute, Houston 1985, ISBN 0-942862-02-3]

In prerelease conceptual illustrations Rawlings did for the David Lee Zlatoff/Disney/ABC '91 movie “Plymouth” (still the only science fiction film ever made about settlement and the idea of using lunar resources), there are sketches of turtleback conformal airlocks (my words) into which this specially designed backpack makes a sealed connection, then swings open, allowing the incoming astronaut to (pulling his hands and arms out of the suit sleeves) reach back and up through the opening to grab a bar above the inner door of the lock and pull himself out of the suit and into the habitat. The suit and most of its dust remains outside, perhaps to be stored automatically on an adjacent rack. Whether Rawlings himself ever thought through his artistic concept this far, or further, is unknown to this writer. But we want to give him full credit.

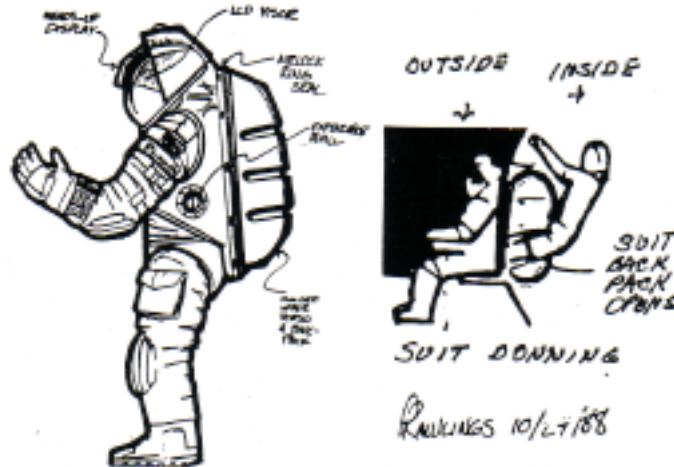

We need to radically redesign both spacesuit and the airlock, co-defining and co-designing them to work together to keep dust outside all pressurized areas.

We will take up this idea and the several engineering challenges it poses in a separate article, hopefully next month after we speak on it at the upcoming MSDC and gather in some helpful feedback. For now, we just wish to point out that we must totally rethink airlocks – and what we allow inside the habitat – as essential to successfully tackling the dust problem. And this promises to be a far cheaper approach, certainly in the long run. Such “suit-locks” will be features not only of pressurized habitat modules, but also of pressurized vehicles. It is a **whole new language** of how to handle the pressurized/vacuum interface in dusty locations on planetary and asteroidal surfaces. It is a language in which spacesuit and airlock are co-defined and co-designed – far from the present case!

### The “Dock-Lock”

In addition, we need to equip everything, vehicles and habitats alike, with unisex “dock-locks” for “shirtsleeve” passage (on the pale analogy of the airport “jetway”). The ordinary traveler on the Moon need never don a suit to leave his abode and go to another habitable location anywhere on the Moon. **This will establish a very real virtual continuity** between all habitable volume on the Moon, mobile as well as stationary, however actually discontinuous our lunar presence may be. Through this sort of pan androgynous interconnect-ability, every vehicle and every structure on the Moon will be **interchangeably contiguous**.

MMM #90 – November 1995

Good  
Housekeeping includes  
Site  
Management

GOOD HOUSEKEEPING INCLUDES SITE MANAGEMENT – By Peter Kokh

It’s simple, really. We just plopp down a basic habitat module and throw some moon dust over it for good luck, add some solar panels or a small nuke, a radiator, an antenna, and a rover — and, voila, we have a Moonbase! Whoa! Doesn’t that leave a lot of unanswered questions?

How will our little baby develop? Are we going to be so quick to show around the latest snapshots of our offspring a few years down the road?

Will future growth and development of our little bundle show that it had “good genes”, or “bad” ones? A well-thought-out site management philosophy with a full deck of guideline zoning protocols, in place from day one, will help guarantee that we will be proud parents, not just shortly after birth, but well down the road. That’s adding “good genes”. If we fail to do this, or put it off as unimportant, the future of our creation will be “amorphous”, and since corrective and reactive measures are never as effective as proactive ones (and always too late), an unhappy McMurdo-style mess is sure to result if we don’t care enough now – while we are planning.

If a definite site, mapped from orbit down to near meter scale detail, has been predetermined, then our site management plan can be quite specific in its initial design, with zoning of the immediate vicinity well thought out. One would hope this is the case.

If, however, we have only a general location in mind, we’ll leave picking the actual site up to the good judgment of the pilot of the lunar descent vehicle bringing in the first load, then all we can have prepared is a manual on the “General Principles of Lunar Base Site Management.” This is how the Apollo landing sites were picked: neighborhood by NASA, block and lot by the LM pilot. It’s unlikely that this will be the case the next time around, when we go to the Moon, not for a science picnic, but to start (hopefully) a settlement.

We’ll probably even have ready a name for the host site, our new neighborhood, as distinct from the name of the outpost itself, e.g. Pioneer Flats, Artemis Beach, New World Plain, Dawn Valley, etc. Perhaps some of the names will reflect who donated how much cash to the project.

The important thing to remember is that no matter how much individual pioneers and scouts may care, without a pre-agreed-upon and then religiously pursued game of site management, chaos will inexorably insert itself. Once allowed a chance to rule, chaos takes on a powerful life of its own. Witness McMurdo Sound in Antarctica, before Greenpeace photographers shamed us before ourselves and all the world. Compare cities that have grown up with a reference master plan and those (Third World villages-become-infrastructureless-megacities, and, to be fair, many a European medieval city as well) that suddenly mushroomed like cancerous weed patches.

### **Basic Principles**

An outpost is more than an architectural complex that we are going to put there, snap its picture, and then leave as a monument. It is presumably a nucleus from which long term “operations” will flow. These operations will impact the site. We need to give as much thought to fitting operations to site as we do to the design of the bent metal of the outpost itself.

At the same time, it would be naive to assume we can accurately pre-glimpse the full range of activities that will characterize our lunar presence down the road, as base becomes outpost and outpost becomes village and village becomes a settlement town. Our site management philosophy and game plan must necessarily be amendable. What we need is something to start from, a handbook of “how not to paint ourselves into a corner”. And that is not that tall an order.

Perhaps others will have something to add to this recipe for a lunar beachhead site management masterplan, but at least a first stab at it would seem to indicate we need to make room for the following:

- (a) Terrain to be left relatively undisturbed, for scenic and esthetic reasons;
- (b) Roadway approach corridors;
- (c) Sites for auxiliary equipment: electric power generation, heat rejection radiators, communications equipment, spaceport, garaging of vehicles, etc.;
- (d) Storage and warehousing of surplus equipment, wastes and potentially recyclable trash, cannibalizable packing & shipping materials;

- (e) Areas where the regolith can be “mined” for useful elements;
- (f) Initial industrial park set-aside; last but not least,
- (g) Vectors for expansion of the residential and other structural parts of the outpost itself.

As/if our presence expands by orders of magnitude, the site plan for the perimeter of the base will have to give way to newer plans that embrace ever larger and larger peri-pherial areas. No problem – if the original plan has good genes.

### **Esthetic Zoning Protocols**

While many a technician or scientist or engineer lucky enough to be part of the original short term crews may not care, the morale both of those who will come for longer stays, and of the millions of supporters at home who will per over their shoulders electronically, vistas out the windows of the outpost observation domes (or whatever) ought to show both human (thoughtfully) transformed areas as well as broad expanses of “magnificent desolation” that are minimally disturbed (or restored). In planning the site, we need to be aware of what areas are in sight from outpost “windows” and what areas will be within the horizons of those coming and going between spaceport and outpost. We need to know which areas of high ground will be broadly visible, as well as which areas will be hidden from view of the window ports of either outpost or spaceport coach. Some of this can hopefully be left in its undisturbed state, visitable from sinter-paved walks or trails. Other parts of the perimeter, necessarily disturbed in the base erection and deployment process, or in base expansion, can be “restored”, regraded and raked. Additional handsome areas can be Japanese style sand and rock gardens, or sculpture gardens – the start of uniquely lunan urban/rural “landscaping”.

Scenic “easements” cannot be left for afterthought, even in latter expansion of the site. Making provision for them will not make setting up our base or outpost any more expensive. It will simply require a bit of timely patience.

As mining operations begin, the availability of large volumes of tailings for the creation of man-made hillocks or embankments to shield storage and equipment areas from casual view will create new options. That we are fairly certain such activities and opportunities will develop, we can take the availability of tailings into consideration in devising the scenic provisions and easements of our overall site plan and its subsequent revision as the base-to-settlement unfolds itself.

Thus we will have both natural and human-landscaped areas. For either, the availability of cleared boulders, shards and other debris becomes so many opportunities for the lunan landscape architect.

Lunar “parklands” and scenic preserves need to be part of every expansion of the radius of operations. With such a philosophy, travelers, visitors, and vacationers will never need to be assaulted with the ugly exposed entrails of our industrializing impact on our adoptive new home world.

Storage and warehousing areas, mining and industrial can be out of sight behind scarps, crater walls, ridges (natural or manmade), hills, berms, in lava tubes, under ramada sheds, etc. The same goes power generation, heat rejection, and other necessary systems, unless architecturally complementary to the moonscape. After all, we will need to be visually reassured of the presence of both the technical and biospheric support eco-systems for maintenance of our presence on this, of itself, alien world. We need to see both the undisturbed beauty, and evidence that we are supported in our needs. The point is that the latter need not be presented chaotically and in disordered fashion. A basic set of esthetic zoning protocols will do the trick. The up-front cost will be minimal. Down the road, such foresight may become a definite economic plus.

The idea of lunar “landscaping” should be taken seriously by Earthside supporters with ready creative instincts and experience. We can’t go around planting “evergreens” or other trees, bushes, and flower beds. But we can do something analogous, assist in the “blooming” of the lunar soil, by bringing into being various human-midwived extrusions of surface materials.



This is not so unlike what Nature does as it brings out various life-midwived extrusions of the geological elements on our own planet.

With mining tailings and other material leftover from road grading, cutting passes through ridges or crater walls etc. it will not be impossible to create what until now have only been fantasy mountainscapes of craggy peaks etc. In lieu of flower beds, we can boulevard or “tree-line” our main settlement approaches with crystal glass snowflakes, ceramic stalagmites, and other roadside sculptures meant to be panned in passing. Roads can also be curbed with split and possibly polished breccias and other lunar “rocks” displaced in the grading process. Nor are we stuck with a palette of grays. We can whitewash with lime (Calcium Oxide) or with Titanium Dioxide, even Aluminum Oxide. We can collect the iron-rich orange soil found first at Shorty Crater, and more recently all over the place by Clementine, and use it in concentrated form to give areas various tints from rust to orange to cantaloupe. And a sprinkling of sulfur could provide a yellow.

Sculpture forests can be planned so that they take on whole new aspects as the Sun slowly marches across the lunar dayspan skies. Trees? Why we have already made trees of aluminum and aluminum foil for Christmas time. Why not sculpture “trees” which are outgrowths not of life, but of the inner potential of aluminum, iron, magnesium, and glass? They could be made stiff and immutable, but why not also with fairy gossamer “leafage” to flutter in the “breeze” of changing sunlight angles and mutual shading interference. “Trees” and “bushes” can be modular in construction using controlled “natural” randomization to vary size and branching patterns and nature-like deviations from symmetry. They could be laden with glass prism fruit to cast an ever changing pattern of rainbow colors. Let your imagination soar. This won’t happen all at once, but give it time!

At night, UV and Neon lighting will eventually be lunar supportable options. Even passive electro-fluorescent lighting, driven by the sun angle and or occasional solar flares – to give an ever changing ambiance – is a possibility.

Road embankments can be dressed with cast basalt or ceramic tiles with various textures and designs. “Pebbledash” panels are also a simple option.

In short the resources of the future lunar “landscaper” know few bounds. The point is leaving thoughtfully saved zones and sectors for him or her to give creative expression.

#### Other Zoning Protocols

Last month, in our article on “Dust Control” [MMM #89 pp. 5–6] we discussed the wisdom of sintering (lightly fusing the surface grains to a load-appropriate depth) aprons around airlocks, and of sinter-paving areas of regular traffic (roads) and areas of regular, routine activity such as areas where exterior systems are placed, or exposed or sheltered “lee” space storage areas for items needed on a frequent basis – the purpose being simply dust control. This can be guaranteed by carefully drawn up zoning protocols and guidelines.

#### Storage and Warehousing Protocols

We will discuss this topic at length in the article that follows. The old adage, “a place for everything and everything in its place” is the guiding philosophy we must devotedly pursue if we are to keep chaos at bay. Do not provide each category with a storage place of its own and voila, you have instant unrecoverable disaster, a good example of which is the Manifesto office where this is being written..

#### Growth Vectors – the Site Plan

While surely we will add new modules to the original outpost complex, it is unlikely that, as we move from outpost to pre-settlement village, and then on to settlement town, that we will just keep adding on. We may want to identify areas of the surrounding Moonscape for starting afresh, for example, once we are able to use made on site building materials to take care of the bulk of our expansion needs. In time the original imported outpost transplanted from factories on Earth may be decommissioned and transferred to other uses: a spartan ‘hotel’ for early visitors, or preserved “as is” as an “historic park”.

Any new “village” or “town” needs to have a plan for expanding residential, agricultural, commercial, industrial, service, educational, administrative and other zones, properly separated, properly intertwined and interspersed, neighborhood after neighborhood, as we grow. We certainly do not need to set out from Earth with such a City Plan already brainstormed in detail. We simply need to be armed with a plenary set of principles, if even in library form.

#### Exclave Concessions

We should not think of the Moonbase Site as encompassing a single contiguous area of set radius from our starter outpost. Depending on the legal regime(s) that may apply, our “concession” or “charter” may designate a fairly generous radius, more and more of which we will occupy and transform as time goes on.

But if we are to move in the direction of providing for an ever larger portion of our material needs as well as export potential through the use of resources indigenous to the Moon, then we may want/need to range further afield to access special deposits of minerals not found within the original site radius.

If we pick a “coastal” site, astride a boundary between highland and mare terrain, this will give us immediate access to the two major regolith soil groups. But we will still need to have access to KREEP (potassium, rare earth elements, and phosphorus) deposits such as those represented in the splash-out from the formation of the Mare Imbrium (Sea of Rains) basin over three billion years ago. Central peaks of larger craters represent a fourth suite of minerals. And then we may find Sudbury like astroblemes rich in asteroid-impact-donated lodes of iron, nickel, and more importantly, copper.

Thus we will need to set up “Exclave Concessions” as well and provide and maintain traffic corridors to such out-sources as well as to other destinations like additional (rival or secondary supportive or dependent) outposts and settlements. Each will need its own Site Management Plan. MMM

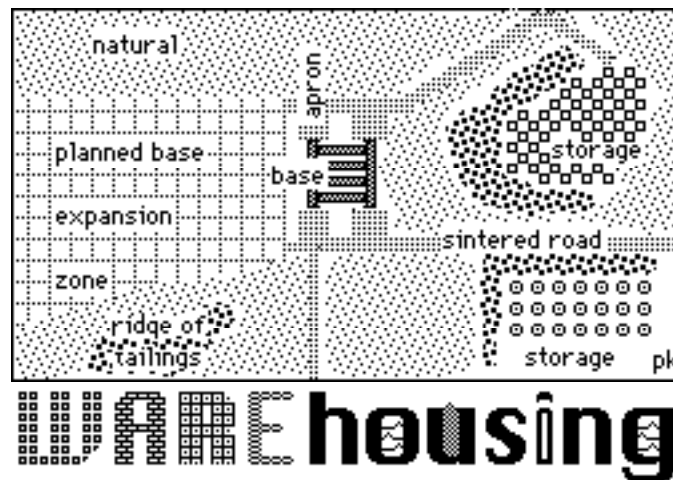

## WAREHOUSING: Avoiding chaos takes a strategic masterplan

By Peter Kokh

### Relevant Reading from MMM back issues:

[Republished in MMM Classics #3] – MMM # 23 MAR '89, pp. 5–6 “TAILINGS”

[Republished in MMM Classics #4] – MMM # 32 FEB '90, pp. 5–6 “Port Nimby”

MMM # 34 APR '90, pp. 5–6 “The Fourth ‘R’” – MMM # 37 JUL '90, p 3 “RAMADAS”

MMM # 38 SEP '90, p 4 "PRIMAGE" – MMM # 40 NOV '90, p 4 "Cloacal vs. Tritreme Plumbing"

[Republished in MMM Classics #6] – MMM # 55 MAY '92, p 8 "SHANTYTOWN"

[Republished in MMM Classics #7] – MMM # 65 MAY '93, p 8 "STOWAWAY IMPORTS"

### **Inbound Storage**

From the very outset, in the first days when the lunar outpost is little more than a very elite group home, it will make rewarding sense to have in place a system of keeping track of everything. Pressurized storage space will be at a premium, woefully inadequate. It will be necessary even from day one to begin using the seemingly endless outvac as closet, attic, basement, shed, garage, and warehouse.

There will be stuff coming in from Earth, hopefully faster than it can be used — reserves. Reserve hydrogen, nitrogen, and carbon (possibly in the easier to store form of methane, CH<sub>4</sub>, and ammonia, NH<sub>3</sub>). Other volatiles and industrial reagents where necessary in the various processing operations. Volatiles, gasses and liquids, will be stored in tanks, and the beachhead site will sport a growing "tank farm" from the first or second landing onwards.

There will be co-imports: packing / crating materials, hopefully strategically made from cannibalizable materials that will become essential as lunar industry gets started in earnest and begins diversifying: copper and brass; stainless steel; poly-ethylene and polyurethane and other easy to remold polymer materials. ("Stowaway Imports", Back Issues reference above).

#### **There will be equipment, lots of it. Capital machinery**

to carry on early mining, materials processing, manufacturing and fabrication operations; equipment needed to set up electric power generation and thermal equilibrium maintenance; equipment needed for recycling wastes.

Many an item on ship manifests will need at least temporary storage outside. Where? First, of course, there will be an off-loading area at the humble spaceport. From there, it will be logical to move items to staging areas near where they will be used in industry, agriculture, construction, etc.

### **Byproduct Storage**

The next broad classification of items needing storage will be that of byproducts of human activities on the Moon. Mining and processing operations will produce veritable mountains of "tailings". As these may be enriched sources of yet other elements, not yet processed, it make strategic sense not to lump all tailings together but keep separate those from each separate type of processing and ore beneficiation operation. Those tailings not especially enriched in anything, can, along with regolith moving surplus loads be used in landscaping operations as suggested above.

Manufacturing byproducts and quality control rejects should be carefully sorted each kind from the rest, against the day when they will become valuable feedstocks for industrial processes and entrepreneurial endeavors not yet begun, even not yet imagined.

Canisters of human fecal wastes can be stored in permashade where they will remain frozen and inert, against the day when they may be an invaluable source of fertilizer in food production and agriculture in general. Prior to storage, these wastes could spend some time in quartz covered trays in full dayspan sunlight, allowing solar ultraviolet to sterilize them thoroughly and effectively.

Finally, "miscellaneous" garbage and trash need to be stored in sorted form according to the nature of their primary and secondary recyclable content. If there has to be some residual Miscellaneous Storage Area, a catch all for everything we cannot yet see a need for, then, nonetheless, each item needs description, qualification, and recording. As a master computer program senses a building accumulation of a particular type of material or stuff not yet separately stored, a new distinct storage area can be set aside, and we will know just where to get everything that can be moved thereto.

How? We use the Double Entry Barcoding Inventory system devised for Mir by John Voigt of Lakeshore Computers in Cleveland, WI. Each item is given a barcode, as is each storage location. As an item is stored, its barcode and that of its location are read as a pair. Nothing ever gets lost anymore.

### **Production inventory — Items awaiting export**

Early export products will include liquid lunar oxygen, LOX or LUNOX for short, and possibly other fuels such as Silane, SiH<sub>4</sub>, both mainly for rocket fuel. These can be stored in the tank farms. If we practice “primage” (every time we move regolith, in road building or construction we heat the soil to extract the precious volatiles), we will begin accumulating gasses that may be useful someday: hydrogen, carbon, and nitrogen; garden variety helium and helium-3; neon, argon, krypton, and xenon. Someday these gasses will be the feed-stocks of new industries, the springboard for a second wave of lunar industrialization and diversification. If need be, the primage extract can be stored as an undifferentiated brew, leaving separation of the various gasses for a later effort.

### **Maintaining Quality of Stored Product**

It may be wise to protect some of these stored materials under ramadas or shed-canopies, to protect them, not from the vacuum, but from attack from the lunar skies: UV, cosmic rays and solar flares, micrometeorites, and bimonthly shock of alternating thermal extremes. Periodic tests should show if any degradation is operating, and accordingly if some items should be depreciated with storage age. Conversely, economic conditions and new entrepreneurial, industrial, and export opportunities, as well as import difficulties could work to appreciate the value of many items.

Some stores we may want out of sight. Yet an orderly storage yard in full sight, as an eloquent testimony of thoughtful self-providence, may be very reassuring. In contrast, the sight of a storage area in helter skelter chaos would be rather disquieting, let alone an eyesore. The yardmaster’s job will be important. It is a job that must be filled, filled with the best.

### **A Lavatube – the ultimate warehouse**

Lavatubes, of whose existence we are confident from indirect evidence (rilles with natural bridges, strings of rimless collapse pits, analogy from terrestrial shield volcanoes made of similarly non-viscous lava), and whose likely scale and size dwarfs known Earthside analogs, present themselves as ideal warehouses. They keep everything out of sight and out of harms way from the celestial elements.

They may not be used for that capacity right away, however, because it would seem that access could present some initially discouraging obstacles. We may need to either erect industrial elevators or grade negotiable access ramps down rough and rugged talus slopes from cave-in entrances. Yet certainly, their great volume and its weather free character will guarantee their use for storage as soon as they can be found and access provided.

“A place for everything, and everything in its place.” It’s not just for closets and desks anymore! It’s a philosophy that will bode well for our future on the Moon, if we abide by it, providing an eventual industrial and entrepreneurial bonanza. Equally it is a philosophy which will spell out our sentence, if we give it but lip service. We can look at it as a sort of “Real Accounts” ledgers, in which we are dealing with real items, not just financial values.

Again, the operative condition is that we start such housekeeping practices from day one, for, as we have warned, chaos, once it has its foot in the door, takes on a life of its own, setting up conditions from which it will be extremely difficult to recover.

**MMM**

## EXPANDING the OUTPOST

### EXPANDING THE OUTPOST

By Peter Kokh

The provident architect, in designing a building – be it a residence, a factory, a school, an office, or a corporate head-quarters – will take into consideration the possible downrange need to expand. For if the tenant of the premises prospers, the structured interior space of the original construction may soon be outgrown. If no provision has been made for easy and orderly expansion, the original site may have to be abandoned, and a new facility built on adjoining or distant property.

Much like the would-be architect using Lincoln Logs or Lego blocks, and even more like the think-ahead Scrabble player, the architect of the original lunar outpost will want to leave a number of opportunities for expansion. His grounded options must provide for changing needs in a flexible way. “Expand EZ” features will mean minimum disruption and disturbance of, and other inconvenience to, ongoing operations

This is the philosophy behind using multi-port nodes as airlock modules, for example. We don’t have to give up a point of access to expand. Spacing of such expansion/access nodes must also be considered. The module or other pressurized space to be added may or may not be of comparable size to the starter module or modules. If connecting ports are arranged at angles to one another, as for example in a cross-T, hex, octagonal or other radial pattern, this provides more sizing flexibility than does an initial configuration with expansion ports arrayed side by side.

Expansion ports should be indifferent to the nature of the added space: hard-hulled payload bay sized modules brought up from Earth; “telescoping” or otherwise unfolding hard-hull modules which allow more usable volume; or inflatable structures. Of these, the cylinder can offer the same or greater volume than the sphere for the same or lower height. And the torus offers a more stable footprint as well as room for built-in features in its “donut-hole” [cf. MMM # 50, NOV ‘91, pp. 6–8 “Hostels: Lowering the Threshold to Lunar Occupancy: Part IV, Hostel-Appropriate Architectures” – MMM C #5]

We have recently touched on another topic which will greatly affect the ease or difficulty of outpost expansion: the manner in which we apply shielding mass made of regolith. If we apply it directly, a certain amount of tedious, gingerly delicate, and messy excavation may be necessary to expose the expansion point decided upon. If we apply our shielding indirectly, as in a hangar shed arch roof over the outpost site, then this shielding will not be in our way when we need to expand, and, as a bonus, the workers affecting the expansion can work in a safer, radiation and micrometeorite free “lee” vacuum under the hangar shed.

The layout of the site must also be considered, and we won’t want to pick a site that unduly constricts opportunities for expansion with too close scenic but in-the-way features like crater walls, rille shoulders, scarps, etc.

#### **Expansion for what?**

We will want to expand our outpost in a timely fashion to provide together both more living space and more operations space. In expanded living space will be additional private quarters for more crew, more and better furnished common space, more recreational and leisure space, more space for added life support and food production, even garden space.

Expanded operations will include: exploration and in-the-field prospecting, mining, material production, manufacturing, expanded sample and product testing laboratory, product fabrication facilities, inside storage, etc. Obviously, reason exists for considerable expansion, stage by stage.

Planning for expansion must be flexible. Some of the things we think we can do and do well enough on the Moon may not work out or present engineering and prerequisite difficulties that mandate putting them off until later. Other unsuspected opportunities for useful and profitable activity that can be supported early on will emerge. The exact sequence of diversification into iron and steel, glass and glass composites, ceramics and cast basalt, and lunar concrete, should be kept provisional and open to unfolding realities of need and ability. Expansion must then be both flexibly preplanned and opportu-nistic. This is in fact how things unfold on Earth. It will be no different on the Moon.

### **Addition of “Out-Facilities”**

Initially, the outpost will be quite compact and integral with the only peripheral installations being solar arrays and radiators, antennae, tank storage farms, the space pad, power generation and storage etc. But he time will soon come when we will want to move industrial operations that have passed their field trials out of the ‘incubator’ space within the original outpost complex into new, more spacious, and more rationally designed industrial quarters more or less nearby. Such indus-trial space may be connected to the outpost by a pressurized corridor tube or “cunicula” of some sort, or it may be accessed, also in shirt sleeves, by a docking personnel transport coach. However, if the facility uses a lot of raw materials “mined” at some distance, the whole industrial operation might better be placed at a suitable site handier to the source.

Another unconnected complex likely to arise early on is a “Port Operations” facility at the Moon base spacepad site, as the pace of expansion increases and with it the amount and frequency of traffic between base and Earth and/or Earth orbit. Additional “exclaves” may be at an astronomical observatory installation within logistical support range of the outpost, and even a sort of getaway recreational retreat, say on the scenic rim of a large not-to-hard-to-reach crater or rille. ‘Androgynous’ dock-locks will make such actually separate installations functionally contiguous allowing easy, safe, and comfortable passage from one to the other. Keeping pace with all this will be an expanding road network, reworked as need be to handle more frequent and heavier traffic loads.

### **Room for Visitors**

At first, there will be no room or provision for “non-working” visitors. As the outpost expands, spare quarters for guests may be set aside (possibly the original, now outmoded crew quarters). Only as the outpost expands to the point where potential income from visitors outweighs the “bother” that looking out for them will cause, will a real ticket-purchasing visitor influx begin. The outpost will then have a dedicated hotel, a tourist excursion coach, and an itinerary of visitable sites. And outpost population will have grown quite a bit. 🇺🇸

**MMM #92 - February 1996**



A “PERMANENT” OUTPOST?

**Permanence has to be earned, not proclaimed**

By Peter Kokh

“Permanent!” You would think its is a cut and dried word. But like all adjectives, its denotation can be justified in degrees. Sure, it’s not at all what we mean when we use the term with reference to our presence on the Moon, but in a sense our presence is already permanent. Even if we never return, indeed especially if we never return, the Apollo astronauts will have left a relatively “permanent” human presence on the Moon. Their bootprints, tire tracks, and assorted left behind equipment and paraphernalia [lunar museum hope chest] should outlast all of us individually, outlast, indeed the most long-lived of the current family of terrestrial nations. It will simply take that long for the process of micrometeorite rain to “garden” the surface at the landing sites to remove all traces.

But that’s not what we mean. The Apollo crews were just on “scientific picnics,” our happy campers taking their lunar module “tents” with them when they lifted off. The next “small step, giant leap” (to use the slogan of the upcoming New York International Space Development Conference – you all come , now!) is for the next returning crew to leave behind a habitable structure, protected from the elements by a blanket of moon dust (regolith) shielding. That goes much further to merit the description “permanent presence.”

Let’s quibble no more. What we all mean, want, is to plunge into a new era, one in which from that day forward, there will never again be a sunset on a moon without humans working and living there somewhere. For the more easily satisfied, the less expectant, that means no crew will ever return to Earth without first being replaced.

But to the rest of us, this is a wooden nickel. What we mean, want, by “permanent presence” is real settlement communities in which a significant part of the population has come to (and someday been born on) the Moon fully intending to live out their lives there, raising families, having children, working for their livelihood, and doing the whole spectrum of human things we call living. Now, in that sense of the term, we are talking about an era of much more ambitious activity on the Moon than are those folks happy to have an Antarctic style government/science outpost with rotating crews.

Our point in this essay is that we can’t get to this higher realization of the term “permanent” from day one of our return with a habitat module, without the right set of plans, without the right official (government, multi-national industry, or private undertaking — i.e. the chief responsible party in charge) “philosophy.”

Philosophy, shunned as irrelevant or useless by self-styled pragmatists, is, whether its principles are sound or loony, the most powerful force on Earth. Everyone operates with an implicit philosophy, even criminals and misfits. As hard to pin down as it may be, as difficult to agree upon as we know it is, is still the ultimate fuel that powers and drives (steers) everything in human activity and history. So it is worth paying attention to, worth trying to get it right, appropriate, and productive of results.

We must sell, and buy, “the ladder” of permanent presence on the Moon, as such — as the whole ladder. It has been, is, and forever will be, a failure-guaranteeing philosophy to attempt to neutralize potential opposition by selling the dream one seemingly innocuous rung at a time.

Why? When we do so, the rung gets designed by a committee with many of the players oblivious of the nature of the rung to serve as a step to another rung, and on and on. Look at our recent past. First, not to alarm anyone, we sold the idea of a space shuttle. That in place we introduced the idea of a space station. That now seeming to finally have a momentum of its own that will lead to its at-long-last realization, many of us are beginning to agitate for a return to the Moon and a first expedition to Mars.

The trouble is, the space shuttle we ended up getting was designed by a committee many of whom did not consider the need to maximize its design so it could best serve as a shuttle to a station. Repeating our mistake, the station, in each of its design iterations, has again been designed by a committee, most of whom have not considered it important to maximize the station as a platform whose primary function is to serve as a springboard for deep space missions beyond LEO and GEO to the Moon, to Mars, to the asteroids.

And so we have an ultra expensive shuttle with which we have to make do, and will get an even more expensive station downward looking in design and function (an easier sell to those to whom we were too timid to close the real ladder).

If we follow suite, the first lunar outpost will be an end all in itself, poorly designed for expansion, or to support the kind of ambitious experimentations and demonstrations needed to properly design expansion phases. If we do sell the outpost, once again it will become “a self-halting step forward.” We will indeed have gained only an inadequate high tech shelter that will be abandoned at the next budget crisis. So much for “permanence” – a permanent “ghost townlet,” eventual “ruin.”

That’s why it is difficult to see the sense of political space activism, aimed at programs rather than at legislative facilitation. “The political process by its very nature cannot produce anything intelligent. “

A commercial, industrial undertaking has much more of a chance, even with myopic MBAs running the show. A for profit enterprise or multinational is far more likely to design and plan in a way that leads to growth – and real permanence. Who has the deepest pockets is an irrelevant consideration. Rather the question is who has the drive, the persistence, the absolute need to succeed?

“A government operation would put primary stress on science while doing token experimentation in the practical arena of learning to live off the lunar land. It will have saved money up front, and the resulting “mule station” will indeed be sterile, in no way pregnant with the future.”

So agitate not for a “permanent outpost.” See to it instead that legislative and treaty roadblocks are removed, that economic incentives are in place. Then we will get a town built brick by brick, settler by settler for the long haul. Not just a permanent ruin-to-be.  
MMM[

## MMM #94 – APRIL 1996



### The “Middoors” – Making do without the “Outdoors”

By Peter Kokh

#### Relevant Readings from Back Issues of MMM

MMM # 5 MAY '87 – “M is for Middoors” – MMM # 8 SEP '87 “Parkway” [MMMC #1]

MMM # 37 JUL '90, p 3, “Ramadas” [MMMC #4]

MMM # 55 MAR '92, pp 4–6 “Xity Plans” – [MMMC #6]

MMM # 74 APR '94, p 7 “Sun Moods” – [MMMC #8]

MMM # 89 OCT '95, pp 3–4 “Shelter on the Moon” – [MMMC #9]

If the principal theaters of lunar life and activity will be subterranean (in lavatubes) or sub'lithic (under the [rego]lith blanket), the supporting roles will be “out on” the surface. Using the Australian experience as a model of sorts, in which their great relatively barren continental “back yard” is known as the “outback,” we’ve coined the phrase “out-vac” for the lunar surface. The out-vac will be a place visited and a medium of passage rather than a place lived in. Most Lunans will never don a spacesuit except in “decompression drills” reminiscent of our fire drills.



Vehicle to vehicle and vehicle to habitat “dock-locks” will allow people to travel anywhere on the Moon in “shirtsleeve environments.” There will be the geologists or selenologists, the prospectors and explorers, and the overland truckers and others whose jobs keep them in the out-vac for long periods. And there will be the self-elevated rugged individualists who throw themselves into various out-vac “sports” such as out-camping, out-cycling, out-climbing, etc.

Shielded ramada canopies will offer protected “**lee vacuum**” for those with regular work duties just outside the airlocks and dock-gates of the town or outpost. In such areas only pressure suits, not hardened space suits, need be worn.

But for most Lunans, the hostility of the out-vac will threaten a wholesale forsaking of what on Earth are “outdoor” activities. Without compensation or accommodation, this loss could be demoralizing for a significant cross-section of a normal population. Some, as we’ve just suggested, will find ways to fashion out-vac activities that are reasonably safe and yet satisfactorily thrilling as well as liberating from the all-so-limited confines of even the most spacious and extensive of settlement mini-biospheres. The importance of such a safety valve cannot be overemphasized.

But for the greater part of the population, the answer may lay in the creation of very generous pressurized commons, nature and picnic parks and playing fields and parkways that, while sheltered from the cosmic elements, nonetheless have an airy and supportively verdant feel to them. As opposed to the more confined spaces within individual habitat homes and edifices which they will serve as interconnectors, we have called such sheltered yet open spaces the “**middoors.**” The middoors lie between the doors of private spaces and the airlocks and docking gates of the settlement proper.

The more generous and more high-ceilinged spaces of the Lunan middoors can be offered by several architectural devices. Pressurized cylinders carrying vehicular traffic can have a radius generous enough to support green strips with hanging gardens, trees, walking and jogging paths, even meandering trout and canoe streams. Spherical or ovoid or torus structures can serve as more self-compact nonlinear park and nature space. Farming and food production areas can provide for public footpaths and picnic oases.

Solar access can be provided more conservatively by bent path “sundows,” by optic fiber shielded “sunwells,” or more radically, as Marshall Savage suggests, by water-jacketed double domes. [See the illustrations in #74 article cited above.]

Well-designed middoor spaces provided in a generous acre per citizen ratio can probably substitute for the open air greenspaces of Earth for a large cross-section of the population. Others will need to come to personal terms with the out-vac. Still others will never be able to leave behind the green hills, the ocher deserts, the blue skies, the thick forests, or the horizon to horizon expanses of ocean deep on the only world they have collectively and individually ever known.

For while we may be able to walk and hike and bike and row and trout-fish in lunar middoor spaces, many other cherished outdoor activities will be difficult to replace: skating yes but skiing and snowmobiling no. Human-powered flight maybe, but powered flight, soaring, and skydiving no. Rowing and canoeing yes, but motorboating, sailing and ocean cruising no. Caving or spelunking in lavatubes yes, in limestone caves no. Berry picking and trout-fishing yes, but hunting not likely.

Each person pondering signing up for the lunar frontier must weigh his or her attachments to cherished activities that may not be supported in lunar settlement biospheres any time soon, if ever at all. And those who take the plunge will owe it to themselves to be politically and civilly active in guaranteeing that the settlement middoors is as generous and diverse and user-friendly as economically possible. Nothing less than the morale and mental health and long-term survivability of the whole settlement is at stake. [REDACTED]

**“Mother Earth?” Of course! But “Mother Moon”?**



**Earth’s Atmosphere › The Moon’s Regolith layer**



**2 distinct, yet analogous types of “Cradle Blanket”**

By Peter Kokh

On Earth we live on the interface of a land–sea surface and a generous atmosphere. At the bottom of this gaseous ocean, temperatures are greatly moderated, and most of the life–frying radiation that permeates outer space is filtered out – in particular solar ultraviolet and the high energy particles of solar flare storms. The atmosphere serves as a protective “cradle blanket” for life on Earth.

Much has been made of the absence of such cradle blankets on other worlds in the solar system. Venus’ atmosphere is crushingly thick, with a surface pressure some 90 times that to which we are accustomed. What’s more, it is extremely hot, sulfurous, and unbreathable.

Mars’ thin atmosphere is enough to support wispy clouds and occasional dust storms, but does a poor job of insulating the surface and filtering out harmful ultraviolet. On the plus side, it is thick enough to allow fuel–saving aerobrake landing maneuvers, even thick enough to allow for aviation to become a major avenue of transportation in the opening of the planet’s extensive frontier, equivalent to the land area of all Earth’s continents. Yet for thermal insulation purposes and UV protection, Mars is functionally as airless as the Moon.

On the Moon and Mars, we will have to live in tightly pressurized habitats, and protect them with thermal insulation and radiation absorbing mass – either in the form of a piled up overburden of loose surface material or by placing our habitat structures in handy subsurface voids like lavatubes.

Fortunately, on both worlds, meteorite bombardment through the ages has built up a convenient surface layer a few meters thick of pre–pulverized material that is readily available for this purpose. This layer is called the “regolith” [Greek for blanket of rock]. Largely rock powder, it contains larger rock fragments and a considerable amount of tiny glassy globes that have resulted from the heat of meteorite bombardments.

While lunar regolith occupies the same physical site as topsoil on Earth, there is an enormous difference. Earth’s topsoil is principally derived from wind and water erosion, which leaves the particles rounded, not rough and angular like the “unweathered” grains in moon dust. Terrestrial topsoils have varying but significant components of hydrates (water–bonded minerals) and of carbon–rich organics (decomposed plant and animal matter). They are also rich in nitrates.

Nor on the other extreme, can regolith be compared to relatively inert beach or desert sands. Sands are mostly silica, silicon dioxide. Lunar regolith is metal–rich in comparison.

In essence, we have to burrow under this rock powder surface blanket. We will live and operate largely not “on” the visible surface at all, but once again on an “interface,” this time between the fractured bedrock substrate and the powdery moondust top layer. Just as on Earth, we will survive and learn to thrive “tucked under a blanket” that provides thermal insulation and UV/Cosmic Ray/Solar Flare protection.

The regolith promises more than that. Its pulverized state makes it a handy and ample pre–mined endowment of the Moon’s mineral resources. Lunar industrial development will build on this ready resource. More, having lain on the surface for eons, the regolith has soaked up incoming solar wind particles like a sponge. So it offers us gaseous wealth as well.

For thermal and radiation shielding, regolith can be blown, dumped, or bulldozed over our habitat structures. We can put it in bags to use for the same purpose but with greater convenience. Vibration compacted and then sintered by concentrated solar heat, it becomes a low performance solid (“lunacrete”) that can be used for paving or as blocks for constructed unpressurized outbuildings, or for decorative interior walls. Flocking regolith on molten glass as it is shaped, or on ceramic greenware before firing may make for an interesting artistic effect. Sifted free of the more finely powdered grains, it may make a suitable soil or rooting medium for both geponics and hydroponics food production.

Finally, regolith will “give up” some of its valuable elements very easily. Pass over it with a magnet to extract all the pure unoxidized iron particles (“fines”). Apply heat and extract all the adsorbed Solar Wind gasses: hydrogen, helium, carbon, nitrogen, neon, argon, xenon, krypton. Other elements (oxygen, silicon, aluminum, magnesium, calcium, and titanium and other alloying ingredients) can be extracted with more difficulty through a number of known processes.

Regolith seems a strange name. Pioneers may shorten it to ‘**lith**’ (‘lith shielding, ‘lith-scaping, ‘lith-moving equipment, etc.) By whatever name, it will play the major role in shaping lunar civilization and culture. For moon dust is another very different yet analogous kind of cradle blanket. It will effectively tuck us in, motheringly, on the Moon. 

## MMM #96 – June 1996

### A Green Security Blanket

How will outpost personnel on the Moon for long tours of duty, and eventually Lunan settlers intending to live out the rest of their lives, cope psychologically with the unending and unrelieved stark and barren moonscapes? Whether traveling on the surface or looking out a habitat view port, they will never spot a stitch of chlorophyll green, of plant life, not even as humble as moss or lichen or slime. We can expect that they will compensate with an unusual abundance of house plants – by our standards.

### The Unending Vigilance for FRESH AIR

Fresh Air 

**“Mini-biospherians will live downwind  
and downstream of themselves.”**

“You can’t just open the window and let in some outside fresh air.” “We can’t go if we can’t breathe.”

By Peter Kokh

#### Relevant Readings from Back Issues of MMM

MMM # 36 JUN ‘90, pp 3–5 “Biospherics,” D. Dunlop – MMM # 51 DEC ‘91, p 3 “Everfresh”; p 4 “Fire Dept.”

MMM # 52 FEB ‘92, p 5 “Dept. of Xity Biosphere”

**The sealed window**

Most of us hopeful and expectant that humanity will indeed spread off planet, have a very unrealistic idea of the difficulties we will have to overcome if we are in fact to be able to successfully engineer and maintain micro- and mini-biosphere environments that work, and work forgivingly, long term. Here on Earth when the inside air becomes polluted from the outgassing of organic and synthetic building materials and from the chemical household maintenance products upon which we have become dependent, we have but to open the window and let in the relatively fresher outside air.

Outdoors, when air quality is bad, we know that sooner or later the wind will bring us relief. In space and on the Moon, even on Mars – anywhere in the solar system beyond Earth's mothering atmosphere – we will not be able to simply open the window, and there will be no outside winds. We will have to deal with the problem, principally by not allowing bad air situations to arise in the first place.

### **Outlawed items**

Not to burden the air with pollutants that may be hard for many to handle in closed quarters, aromatic substances in general may be proscribed in more than subliminal quantities. Anecdotally, this will mean relying on honest hygiene as opposed to masking colognes and perfumes. Even in very small doses, in closed environments where there is no inside-outside air exchange, consciously detectable fragrances may become oppressively suffocating to many.

All materials outgas, synthetic materials especially so. Fortunately on the Moon, there will be little use of such materials for economic reasons. They can't be produced from locally available material stuffs, and importing them, or their stuffs, will be prohibitively expensive. This will make lunar habitat space much cleaner than most terrestrial interiors from the get-go. But that's only the start.

Cooking odors, as much as we love them (save for chitterlings), can also become oppressive when there is no air exchange with the outdoors. Open boiling and frying may be verboten. Microwave and pressure cooker food preparation may be the way to go. If you're on the ball, you just realized this means no more "backyard" or patio barbecues. Restaurants with autonomous closed loop air circulation systems may be permitted an exemption. The cost of such equipment will be reflected in the price of those ribs and steaks, however (as if the cost of importing such meats wouldn't be pricey enough).

### **The "middoors" – fresh air faucet and stale air sink**

Once we begin to construct settlements properly speaking, pressurized spaces will begin to sort out into relatively volume-restricted interiors of private quarters, offices, shops, etc. and the relatively volume-generous pressurized common spaces of streets, alleys, parks, and other commons, on to which the "indoor" spaces open. These pressurized all-interconnecting commons we have dubbed the "middoors." There will be air-exchange between "indoor" and "middoor" spaces, all within the continuous settlement mini-biosphere. That will be the source of some relief.

To make the middoors system work as both fresh air faucet and stale air sink, there will have to be a xity plan ["xity," pronounced ksity, is an MMM-introduced word for an off-Earth (i.e. the x is for exo) community that has to provide its own biosphere, something no city on Earth has to do] that carefully arranges farming, residential, commercial, and industrial areas so as to create an air circulation loop cycling probably in that very order and back again. All mini-biospherians will essentially be living downwind and downstream of themselves, and this area zoning will provide the only limited buffering possible.

How do we do this and still allow for urban growth? The answer may lie in a cellular xity plan, in which each neighborhood has its own locally balanced area zoning and air quality restoring circulation. One happy result of such an integral neighborhood by integral neighborhood (or urbicell) plan is the millennia-overdue reintegration of city and farm, a restoration of the healthier pattern of farming villages. In the xity, as opposed to the city, vegetation will once again host humans, not humans hosting mere token house plants and landscaping accessorizers. (See the following article.)

In addition to the zoning pattern, there will have to be active ventilation and circulation assists in the form of fans. Air circulation need not be strong, nor steady except in an averaged sense. A certain randomizing of velocity and vector can simulate the pattern of natural breezes.

Part of this air circulation / freshness regeneration loop will be humidification in the agricultural areas, with fresh drinkable water coming from dehumidifiers elsewhere. Using water reserves in later stages of treatment for plant misting, water fountains, and waterfalls, will help control dusting and provide pleasant just-after-it-rains air freshness. Negative ion boosters can also be used here and there.

### **Fire and Smoke**

As we learned from Skylab experiments in 1974, fires in orbiting spacecraft spread only one-tenth to one-half as fast as they do on Earth, provided there is no fan-assisted ventilation. On Earth, hot, thus lighter, combustion gases flow upward, and fresh, oxygen-rich air is pulled in to replace them, fueling the fire. In free fall space, there is no 'up', and no buoyancy effect. On the Moon, in still air, spread of fire by convection will be slowed, but still a factor, and fan-assisted ventilation is a certainty.

Far more important in all off Earth situations is the fact that we are dealing with sealed micro-environments. There is no fresh air reservoir "outdoors" and we cannot "open the window" to let out the smoke. While the flip side is that habitat fires will inevitably extinguish themselves through oxygen starvation, this will only occur long after they have resulted in very final casualties wiping out all unlucky enough to be present. In short fire cannot be tolerated, cannot be allowed to happen.

Fortunately, in lunar mini-biosphere environments, we will see extremely limited "gratuitous use" of combustible materials, other than for next-to-skin clothing. Furniture and furnishings as well as building materials will be all but exclusively inorganic and incombustible.

On Mars, that need not be the case, and so fire there could be a much more real danger. Possibly, through the Lunar experience, we will have become sufficiently weaned of the organic stuffs (wood, paper, plastics, foams, fabrics) so easy to provide in the macro-biosphere of Earth, that even though the volatiles-rich environment of Mars will support their reintroduction and our re-addiction, Martian pioneers may choose to forgo these temptations, living much as Lunans do.

### **Questions in search of answers**

The Biosphere II experience gave us some answers to questions we didn't suspect existed, and even more importantly showed us the extent of our ignorance. There were problems maintaining the proper percentages of both oxygen (too little) and carbon dioxide (too much). We discovered some building materials (e.g. concrete) to be oxygen sinks.

Off planet, we don't even know yet what nitrogen oxygen ratio it will be safe to use. Nitrogen may need to be imported, and the less we can get by with the better.

We scarcely know how to build a biologically assisted closed loop air system, much less a principally biologically maintained loop. The Space Station (Mir or Alpha) rely on continual resupply shipments of fresh water and make-up air.

### **A wakeup call**

That will be no way to maintain a lunar outpost. Nor will it be a way to support a Mars mission —not on the planet, not even en route, going or returning! In plain fact, had we the money, we could not go. It's not transportation technology that will hold us up, but budgeting and policy failures to support the programs needed to develop closed loop life support systems. Meanwhile hardware jock space enthusiasts ignore the problem like so many ostriches. This attitude and our lack of involvement have to change!

We can't go if we can't breathe. It's as simple as that. Those who have survived near death experiences tell us that the most horrible way to die is not fire, as I would imagine, but drowning or suffocation – the absolute psycho-logical panic of not being able to draw the next

breath. Fresh air is not a luxury, nor just a good idea. We'd better be sure we know how to maintain it.

MMM

## => => || THE QUEST FOR || <= <= ELBOW ROOM

THE QUEST FOR ELBOW ROOM By Peter Kokh

### Relevant Readings from Back Issues of MMM

[MMM #1] # 5 MAY '87, "LunARchitecture" -

[MMM #3] # 28 SEP '89, p 5, "Sardine Can Fatalism" #

[MMM #5] # 48 SEP '91, p 4 "Hostels: Foreword" - # 49 OCT '91, pp. 3-7 "Hostel Share of Workload" # 50 NOV '91, pp. 6-8 "Hostel Architectures"

[MMM #8] # 75 MAY '94, p 1 "Lebensraum"; pp 4-6 - "Successful Lunar Appropriate Modular Architecture" -

# 80 NOV '94, pp. 9-10, "Stretching Out"

### "Canned" habitat space

If spacesuits are restrictive, so will be "canned" Made on Earth habitat modules. In the beginning, there will be no easy alternative. On the Moon, local building materials and the factories to produce them and use them to manufacture shelter components will be an early "priority," read "not-immediately-realizable." Competing designs for habitat modules to be built on Earth and shipped to the Moon will be judged both on how compact they are and on how light they are. These are unavoidable shipping concerns with all foreseeable transport options.

There is a long tradition behind sardine can space, much of it in pre-nuclear era submarines. That people on short tours of duty a few months long at best can adapt to such cramped hot-racking conditions with minimal privacy or other personal amenities is well established. Anything is bearable if there is light at the end of the tunnel.

### Relief from good human factors design

But a lunar Outpost Interface is not meant to be a military operation. It is a facility that cannot fulfill its mission if it does not foster experimental and even artistic creativity in learning to adapt to an utterly unfamiliar environment with no experience-recognizable assets. The base will have to be much better designed than a W.W.II era sub to foster the high morale needed for success under the challenging circumstances. Pairs of berths used in shift sequence can trade off shared elbow room personal space, via a movable partition. Common areas can be cheerfully decorated and partitioned to create the illusion of more complex, therefore psychologically more generous space. There should be getaway retreats one can sign up to use, and quiet spaces, and noisy gregarious spaces. And there should be rotation of duties, qualifications allowing.

### Hybrid rigid inflatables

Well before "in situ architecture" using locally produced building materials begins to supply substantially more spacious quarters for personnel, activities, and operations, hybrid "rigid-inflatable" modules that compact for shipment, and expand upon deployment, all the works and systems in a rigid attached component (end cap, floor, ceiling, or central core). Such hybrids with their fold down, pop out, snap up furnishings opening into the inflatable space out of the attached rigid works section, will solve the frequent objection to inflatables based on the need to spend much time outfitting them after deployment. [see the MMM # 50 reference above.]

These hybrids will allow more generous, if still tight, personal quarters, and common space for recreational activities which could not previously be supported. more importantly they

will offer space for more storage of equipment, samples, and experimentation — all prerequisites to advancing to more demanding mission tasks in the overall framework of learning how to live and work productively on the Moon. **Time sharing and other tricks**

Time-sharing of all common facilities by a full three shifts will always be essential to getting the most product out of every facility and piece of equipment per dollar spent and time elapsed. On Earth, the part time use of facilities in line with day shift chauvinism is the single most wasteful aspect of all terrestrial economies. Fortunately, on the Moon artificial lighting sequences allows us to engineer out of existence any advantage of one shift over the other, removing all chauvinism and preferential treatment.

Providing the option of duty reassignment and or the chance to be reassigned to other sites, or at least to visit them, will greatly relieve the symptom of feeling trapped and caged. The flip side is that this need will motivate parties involved to open up ancillary sites, making a humble down payment on an interdependent multisite domestic lunar global economy.

### **Made on Luna shelter**

Even with this expanded repertoire of tricks, imported pressurized space will remain at a premium. The flip side is that there will be an equal premium, a reward incentive, for the early development of lunar building materials and an ever expanding suite of shelter components made from them. The options most frequently considered are lunar steel, lunar concrete, and lunar glass-glass composites. The points on which a decision will be made are these;

- ✓ mass of capital equipment for processing, manufacturing, and assembly and construction that must be brought from Earth to realize the capacity.
- ✓ number of man-hours needed to process, manufacture, assemble and deploy equivalent structures in the competing materials
- ✓ diversity and variability of modular plans to which the competing module suites lend themselves

For successful “Lunar Outpost Conversion” i.e. transition from an Outpost Interface to a Settlement Incubator, timely steps must be made to develop lunar building materials and manufacturing and construction methods suitable to them. We must take the plunge, not just talk about it. For more, see the MMM # 75 reference given above.

### **lava tubes – real but limited relief**

The use of spacious lunar lavatubes which provide lots of ready made protected “lee vacuum” are most attractive for the expansion of area-intensive industries and warehousing operations. But in themselves, lavatubes do not address the need for expansive pressurized volume, only the doing away with the need for emplacement of regolith shielding. In lava tubes the same solutions apply: good human factors design and time sharing, the use of hybrid rigid inflatables, followed by the introduction of shelter space built of lunar materials.

Well down the road, if ways are developed to safely seal and pressurize their vast volumes, lava tubes could provide all the elbow room Lunans will want for a long time to come. But that day does not seem to be just around the corner.

### **Altered expectations**

The American expectation of some 750 square feet of housing per person, will not translate well to the Moon, nor should it. In the typical room, many spaces are minimally used. Dining rooms for example. Even bedrooms. The Lunan home architect/planner will need to develop multi-use spaces, with fewer rooms that are in fuller use.

Bedrooms can double as office, sewing room, den, or whatever. How? Back to the Murphy bed and the efficiency apartment idea. A bed that is unoccupied and neatly dressed may look nice, but two thirds of the day is just wasting dearly bought space. Dining will be another function that time-shares space with other activities. And so on. Native-born Lunans who’ve known no other way to live, will look on our homes as expressions of an obscene waste of space. (A four bedroom home to himself, this writer is more guilty than most).

### **The Great Home concept**

This said (on the need for fuller time use of domestic space), opposing considerations demand attention. Families and households do not stay the same in their need for space. They grow and they contract. Our typical response is to move to larger or smaller quarters as appropriate. Or we add on to existing structures as the household grows, building additions.

As the pool of new housing may be in priority demand for new arrivals on the Moon, the mobility index of Lunans could well be much lower. Moving may be a less facile solution. Nor will expansion be easy. In the early era, habitat space is likely to be modular and individually shielded against the host vacuum. That will make construction of additions a much more expensive, difficult, tricky, and even risky proposition than on Earth. It'll be more logical and easier to build a homespace large enough from the gitgo to accommodate the average fully grown family, perhaps even with "mother-in-law space." The "Great Home" concept.

Properly designed, a Great Home's temporarily extra volume can be put to good use. For example it can include a separable autonomous apartment that can be rented out to new couples on a waiting list for their own home, or as bed and breakfast space for travelers. Or it can house a family's startup cottage industry. It will be easier and less expensive to put room space designed for future household growth to good use, than to disruptively construct add-on room when needed.

### **The street**

The pressurized passageways of the settlement will be the glue that holds everything together. Modular individually shielded pressurized units will open onto the street/alley/gallery network, tying everything into one continuous minibiosphere complex. We suspect such passages will also be multi-use social glue areas, with broad enough shoulders for landscaped strip parks and garden terraces, areas for marketing cottage industry wares, wears, and homemade foods, for rummage sales and street entertainers, sidewalk cafes and relaxing park benches amidst the thriving activity of an intensely productive settlement. Like our suburban malls, settlement streets will be the place the place to hang out and socialize.

Well sound-buffered, the streets will be active 24 hours serving a fully three-shift settlement, with no shift having any natural privileges. During the nearly 15 day long dayspan, streets can be naturally sunlit around the clock. During the equally long nightspan they can be artificially lit.

### **Commercial and industrial space**

In similar fashion, shops and stores (those that are not Ma and Pop operations, anyway) and factories will need to justify their expensive pressurized square footage by being open for business and operating around the clock to serve and employ three equal shifts of the population. This will even go for administration, libraries, schools, and parks. Nothing short of this can possibly be justified.

### **Tricks again**

As with domestic spaces, good human factors design can make small spaces seem larger. Important in public spaces will be variety and change of ambiance from place to place. Much as in the Moscow Metro (subway) each station is a totally different work of art remarkable unto itself, street architects and landscapers may be called on to give each individual passage its own personality, probably with strong neighborhood involvement and feedback. Surface finishes can differ. Landscaping patterns and the planting mix can differ. And surely, as a unique expression of each neighborhood, sidewalk-showcased cottage industries will differ. The result will be to make the settlement-as-a-whole seem satisfyingly larger and more "metropolitan" in flavor and complexity than its small population might suggest. That'll be a happy, healthy effect.

### **More than a short term problem**

Some generations into lunar development and settlement, Lunans may begin to move into more Earthlike settings as pressurized megastructures are built within which individual buildings of a type more familiar to us can be built, open to the faux sky blue firmament of a crater spanning dome or rille-bridging vault or within a spacious sealed, pressurized, yet sunlit



lava tube complex. We dare predict space will still be at a premium. For we've been neglecting (rather postponing the discussion of) something vitally important.

### **Mini-biospheres need elbow room too!**

It is not enough to relieve psychological crowding for the inhabitants. If they are to thrive, it is even more important that the biosphere be ample and grow, not just in pace with the population, but well ahead of it. That is it should be the goal to quadruple the supporting biomass as we double the population, so that the per capita biosphere support increases to a more healthful, more Earthlike ratio. Not only will lunar settlements see the return of the farming village, we will want to add wilds and nature preserves, greatly diversify the flora as well as the food crop mix, and continue to work in ever more wildlife. Long term, it is only such a development that can secure a settlement's future, advancing it toward biospheric self-maintenance. Also long term, it is only the hope and expectation of continued real progress in this direction that will make lunar settlements psychologically healthy places for Lunans to live and work and raise families.

**Conclusion:** The quest for elbow room will be a permanent feature of Lunan settlement culture. **MMM**

## **Against the Overwhelming Barrenness of the Moonscape**



A GREEN SECURITY BLANKET By Peter Kokh

### **Relevant Readings from Back Issues of MMM**

MMM # 8 SEP '87, "Parkway"; "Animal Life" – MMM # 50 NOV '91, pp 8–9. "Trees"

MMM # 53 MAR '92, p 6 "Xititech III. Cellular Rhythm" – MMM # 54 APR '92, pp 5–6 "Xitiplans"

MMM # 76 JUN '94, p 1 "Windows, in with a new cliché"

Some of us are house plant nuts, some of us are hobby gardening enthusiasts. But perhaps most of us don't give vegetation, indoors or out, much thought. We don't have to. Given the general luxuriant feel of the outdoors, we get enough of a green-fix automatically without having to concern ourselves much about it. And that remains generally true, even in this era in which the health of the host environment is in question, and living nature under siege from selfishness, greed, and simple carelessness.

On the Moon life is not a given. There is none of that comforting green stuff maintaining itself on automatic. The outdoors is lifeless, barren, sterile – relentlessly so – assertively so – threateningly so. Greenery within the protected confines of the mini-biosphere will become a preoccupation of all but the most soulless personalities.

That a healthy abundance of plants contributes significantly and noticeably to air quality and freshness will be a reinforcing motivation. (NASA-funded studies have shown that the right mix of houseplants can be quite effective in reducing household airborne pollutants.) But we suspect that for most Lunans, the real driver will be the need to use plant life as a security blanket, a psychological filter against the out-vac's life-quenching sterility, much as for smokers, a cigarette makes the world a friendlier place (no, I am not one).

If lunar homes and offices and schools have windows affording moonscape views, inside window box planters of houseplants will take the edge off the life=threat of that magnificent but deadly desolation. But we will find many other nooks and crannies to put plants. Greenery

and foliage will become the mainstay of interior decoration. Everything else will play but a supporting role.

A much higher percentage of Lunans are likely to be home gardeners. They will be aggressive in finding opportunities to add plants. Quite possibly a solar-lit atrium space will become the organizing focus of choice in purchaser chosen home plans. Such a space will afford vegetable and herb gardens or a mini-orchard to help with the food budget and menu variety, maybe a tad of entrepreneurial canning. But it could also be devoted to purely decorative plantings of variegated foliage and flowering plants, song birds, humming-birds, and butterflies. Or it could become a more mystical place, a Japanese style sand and stone garden. For despite the general preoccupation with plant life, there will still be a big range of personal sensitivities, and of lifestyle needs.

Architects in general will look for ways to build-in planters and other cubbyholes for plants, providing also for their illumination. Vegetation will be a new design parameter.

Out in the "middoors" too, every opportunity to tuck in vegetation will be aggressively pursued by architects and users. Middoor streets and passageways, intersections and squares, are likely to become as verdant as they are busy. This can be the concern of the xity administration, or, more health-fully, of rival neighborhood, and street merchant associations, or other stretch-"adopting" clubs.

While green will be the dominant color thus inserted into settlement life (architects and decorators will be motivated to find ways to introduce ambiently lit sky blue ceilings and open space sky blue vaults), settlers may rely on plant life to provide other colors as well. The early lunar art pallet (water-glass-based metal oxide "paints" and ceramics) will be one of generally subdued colors. As helpful as such additions will be, the thirst of the more vivid coloration of flowers (and perhaps birds and butterflies) will be strong.

It is likely that flowering plants will be staggered so that at least something is in bloom every sunth (the lunar dayspan / nightspan cycle). Will flowering plants grow taller on their own in sixthweight? Or can they be coaxed to grow taller? If so, Lunans may be able to savor the delight of floral "forests." These would provide a must-see tourist draw.

Trees are likely to be of the dwarf variety (many fruit-bearing dwarf hybrids are already marketed), more bush-like in size, at least until the cost of imported nitrogen makes economically feasible the construction of higher-vaulted middoor spaces. In the meantime, to fill the void, individuals and clubs may take strongly to the cultivation of bonsai trees, even to the point of growing bonsai forests, again a tourist must see.

The first parks may be interim floral and grassy meadow refuges within agricultural areas. Even if the farm units are highly mechanized assemblages of trays and racks and LED lighting arrays, the sight of so much greenery (and the freshness of the air) will make any kind of food-producing area a mecca for those living or working nearby.

In the previous article, we mentioned that mini-biospheres will guarantee the reintegration of city and farm, the overdue return to farm village roots and a more nature-harmonious lifestyle-paradigm. Already in this century here on Earth, most developed cities have thinned out greatly in density, giving much more space to greenery (even if still more to pavement, in homage to the great god Auto).

Also on Earth, we have seen a general increase in urban and especially suburban wildlife, a welcome turnaround, led by post-human species, species that have learned to thrive in human-dominated environments. We can hope that Lunans will indulge in the luxury (to bean counter eyes) of urban wildlife. We've mentioned birds and butterflies. Surely bees, ducks, swans, flamingos, squirrels, even deer, and more.

In our cities, pockets of life are seen as a concession to nature. In the off planet xity, pockets of humanity will be the concession. Vegetation will play the host. The Xity will be an exercise in symbiosis, man and Gaia reunited. 

**FORWARD:** The lunar “maria” or “seas” (of cooler lava) which are especially extensive on the Moon’s Nearside, constituting 39% of the surface facing Earth are laced with subsurface lavatubes much larger than those on Earth, in some inverse relation to gravity. Many writers have proposed putting outposts and settlements within these “already amply shielded spaces.” These networks have yet to be mapped, but we see their entrances here and there. But building and construction inside a lavatube will bring its own set of challenges. In time, we will surely make use of this amazing resource.



## Brainstorming an Early Lavatube Town

By Peter Kokh

Many of our readers will be familiar with the classical Island II “Stanford Torus” space settlement design [Space Settlements: A Design Study, NASA SP-413, 1977]. Not counting multiple levels, this ring with an overall diameter of 1800 meters and a torus cross section of 130 meters, has a circumference of 5.655 km or 3.5 miles and a usable surface area (lower slopes included) of about 50 acres.

With multiple levels, it was estimated some 10,000 people could occupy 106 acres (Manhattan like sardine packing, i.e. quite dense by modern urban standards of c. 5,000 people per square mile = 640 acres.) That seems overdoing it especially since off Earth settlements wherever they are will first and foremost be farming villages: = lots of plants hosting very few people, not vice versa.

But thanks to the copious artwork that has accompanied the settlement design studies of the seventies, such a torus does give us an assist in conceptualizing a lavatube settlement. Cut it at one point and unroll it, and you have something comparable, if on the small end, to what we might someday see in lavatubes. The average lavatube is likely to be several times wider than the torus of the NASA study.

interior torus view, art by Pat Hill, IBID, p. 90

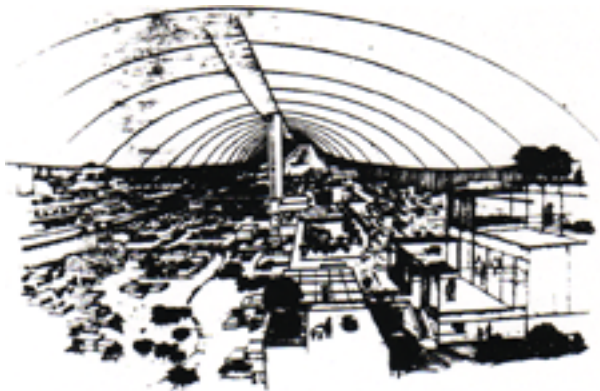

In practical fact, however, this scene gives us more of a goal to hold before us, than a model for feasible near term reality. Sealing a lavatube so as to pressurize it may be easier said than done. If we succeed, filling the immense volume with the usual buffer gas of nitrogen

imported from Earth in a 4:1 ratio with lunar oxygen may be budget-busting. But more on this in an article below.

Near-term, pressurized ceiling clearances will have to be kept to a minimum. We will use lavatubes at first not to escape the vacuum, just to escape the deadly cosmic weather that normally comes with vacuum – on the exposed surface.

The tube ceiling vault functions analogously to the Biblical “firmament” protecting Lunans in their hidden valleys (lavatubes) from cosmic radiation etc. and from the otherwise omnipresent dust. Even if the tube is not sealed and pressurized it may be feasible to spray a high albedo coating on the upper walls and ceilings (CaO lime, or Aluminum Oxide or Titanium Dioxide, all producible cheaply and in quantity, are white. The trick is to make an anhydrous “whitewash.” Unfortunately, bluing this inner “sky,” e.g. with locally-producible cobaltous aluminate would be expensive.

Sunshine could be brought in down simple shafts or through optical cable bundles, to be turned on this sky-firmament, thus providing comfortable daylight type ambient light. During nightspan, nuke or fuel-cell powered lamps on the surface could use the same light transmission pathways. Possibly any whitewash material on the upper vault of the tube could have a phosphorescent component for a night span treat. Imagineering, it is called.

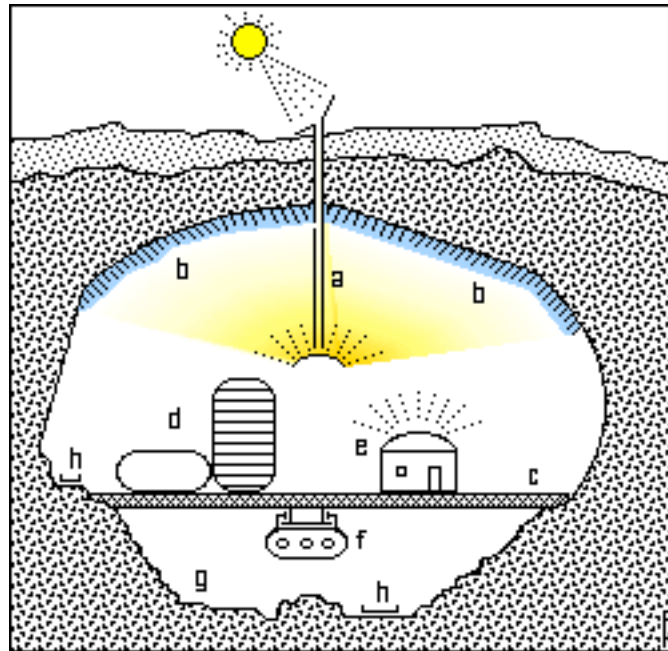

KEY: (a) sunshine access and defuser system; (b) whitewashed “firmament” for best sunlight reflection; (c) “town deck” on tube-spanning beams; (d) assorted structures; (e) “yurt/hogan” type home with translucent dome to flood interior with firmament-reflected sunshine; (f) monorail transit system; (g) lavatube floor left natural; (h) nature walks.

Instead of grading or even terracing the lavatube floor, it could be left natural with the town built on a space frame deck spanning the lavatube shoulder to shoulder. an overhead crane riding rails along the sides of this deck could be useful in constructing/erecting habitat structures. The use of stilt platforms is a possible alternative to the deck span, shoulder to shoulder beams

Elevators to the surface can either be incorporated into “skyscrapers” reaching to the tube ceiling, or be built free-standing to provide great views of the town on the descent from or ascent to the surface.

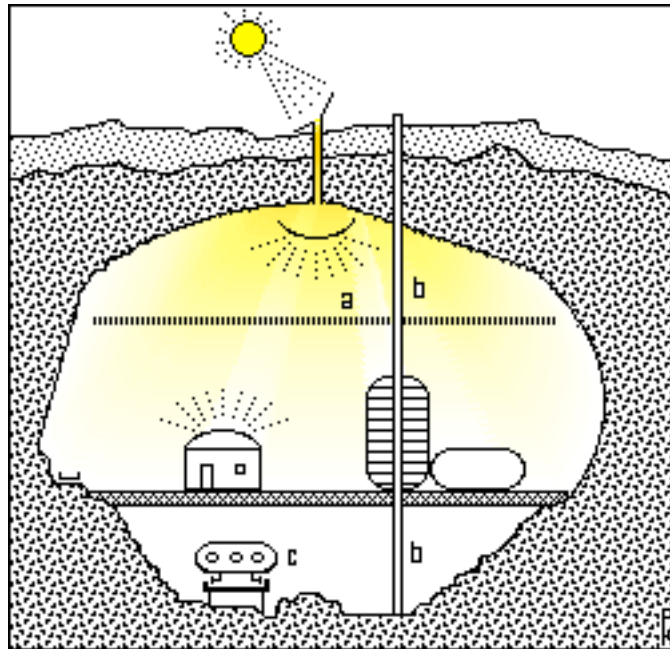

Access to the settlement from the surface is vital. This can either be by freight and passenger elevator shafts or by a ramp road up the talus slope of a nearby natural entrance. We think the first option will bear the brunt of the traffic.

**KEY to illustration above:** (a) sunshine access via suspended “daylux” defuser grid instead of coatings; (b) elevator shaft through “skyscraper”; (c) transit system on stiltway over tube floor.

The tubes are given to us dust-free. Thoughtful engineering of tube access systems will help keep them that way. For example, elevators could have their topside terminals opening not onto the dusty surface directly but onto a suspended platform/launchpad complex.

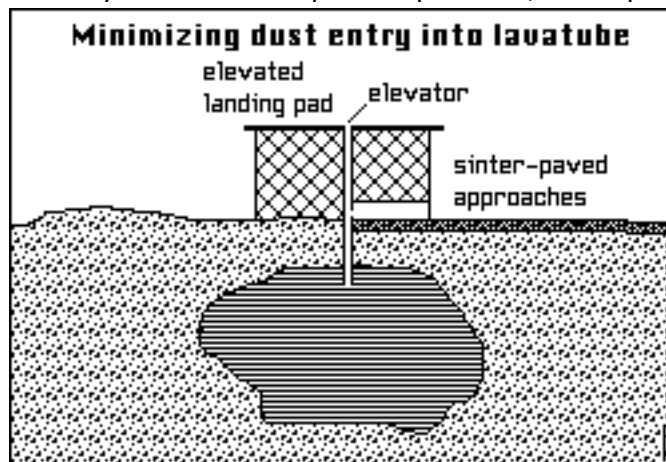

Appearances aside, a vital part of the settlement will be out on the surface and building material and component manufacturing out of “pre-mined” regolith, “the” asset of the surface. Once a processing, manufacturing, or gas scavenging position is past the “dust-using” phase, further processing, manufacturing, assembly, or separation can be more safely and more economically done in the lee vacuum environment within the lavatube. Industrial siting decisions will take into account the degree of involvement of solar power and concentrated solar heating. Operations that are electricity driven and not reliant on moondust, will be the first to move into the tube.

For the lunar architect and contractor, however, freedom from the need to be concerned with shielding is a considerable gain. Tube residences and other structures can have simple windows, and lots of them, through which to behold these nether-world landscapes. The shielded windows of in-surface structures which use mirrors and bent optical paths to thwart radiation, will be a cumbersome relic of pioneer beachhead days, still used where Lunans must live in the regolith blanket surface rather than in provident subsurface voids. Tube structure windows may be characteristically convex, curved in to the pressurized interior, so as to put the panes under compression. Glass and concrete are stronger under compression than under tension. Nor will in tube windows need sacrificial panes.

The subsurface Moonscapes within the lavatubes will be quite different from the surface ones, though sharing one all important, all infecting aspect: their barrenness and sterility. So tubers may share with topside moles the practice of placing plants in front of windows as a psychological filter.

Many architectures are possible. One simple tuber home plan would be a squat 2-story vertical cylinder section topped off by a convex-paned geodesic dome to let in the tube's ambient light. The design type might be called the Yurt or Hogan after the Mongolian and Navaho home shapes it resembles.

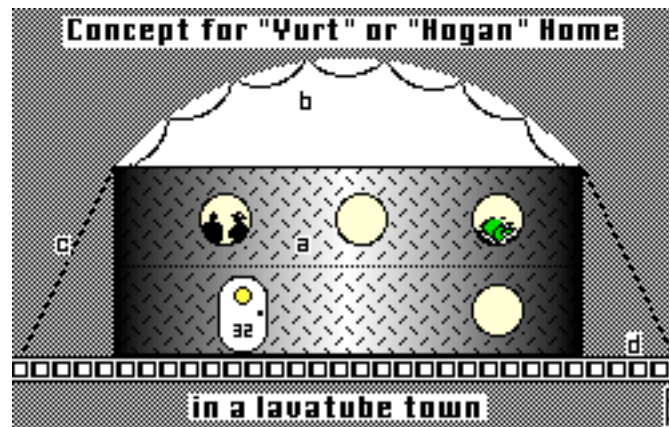

**KEY:** (a) 2-story vertical cylinder section, bedrooms on the lower level; (b) lunar translation of the geodesic dome for a high trans-lucent ceiling vault over the family room and other common areas including a central garden atrium; glass panes are neither flat nor concave, but convex; (c) cable stays prevent internal pressure from literally "blowing off the roof"; (d) the residential deck of the townsite, leaving the tube floor ungraded.

**NOTE:** upscaled, the yurt/hogan design will make a fine church, synagog, or meditation chapel, with the simple use of stained glass convex panes in the roof dome. A shaft of direct sunshine on such a dome would surely help set the mood.

The early lavatube settlement will not be an assembly of individually pressurized buildings, but rather, like the in-surface burrowings, a maze of structures conjoined by pressurized walkways, streets, alleys, and parkways. In the nether-spaces, thoroughfare cylinders can be generously paned with convex windows to flood their interiors with ambient reflected and diffused sunshine and views.



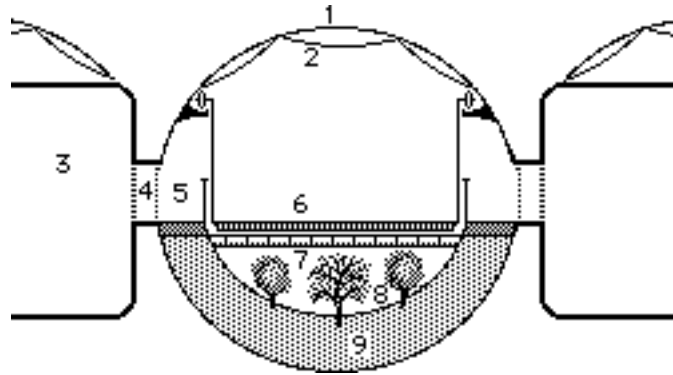

**KEY:** (1) cylinder section; (2) convex-glass panes to let in ambient reflected sunshine and views; (3) Yurt/hogan style homes opening onto street via entrance tubes (4); (5) pedestrian "sidewalks"; (6) rail-suspended goods delivery platform; (7) "crosswalks"; (8) landscaped, concrete free garden strips; (9) dust-purged, conditioned regolith geponic soils.

Along with solar access for reflection off coated upper tube surfaces, there can be some sunshine ports that direct intense pools of light downward, say on the convex-paned lunar geodesic domed park squares. Nothing is so soul-renew-ing as a visit to a pool of strong over-illumination, the feeling of being outdoors in the undiluted brilliance of the unmediated Sun. Directed sunlight, minus the infrared removed by proper glass filters, will also be needed over agricultural areas.

You can see how construction and architecture in lavatube settlements differ from the other types of in-surface settlements we have discussed before. Initially, there will be a strong reliance on inflatable structures and inflatable-rigid hybrids. Here, in lee vacuum, with no need to cover them with shielding, no vulnerability to micrometeorite puncture or ultraviolet and flare and cosmic ray aging, inflatables will have their heyday. All the same, as the costs of new made on lunar building materials and building components come down, and appropriate construction and erection methods are perfected, the bottom line money consideration will move settlement expansion in that direction.

An intermediate phase may involve the use of inflatable structures as slipforms for cold-casting (poured and sprayed lunar concrete) and arch/vault component placement.

As more generous endowments of nitrogen become financially feasible, larger domes over park space commons will make their entrance, affording a more generous "mid-doors" and the more obvious comfort of luxuriant flora and fauna, plants and urban wildlife.

Meanwhile, in the lee vacuum but visible out the abundant windows of lavatube structures will be other extensions of the settlement: sculpture gardens and Japanese style rock landscaping. Electronic displays on the tube walls, even something reminiscent of drive-in theaters, or should we say through-the-windshield theaters? Backlit murals on glass can infuse the citizens with the dream of a Green Luna, not altogether out of reach. And I'm sure sooner or later we'll see some gross examples of tagging by artistically inclined youth without direction or access to approved ways of expression.

Nature walks can educate citizens on the fine points of lunar geology, variations in lavatube textures and formation.

The lavatube settlement will not be a solitary community. To provide around the clock manning of industrial and agricultural facilities owned in common, a string of 3 villages with staggered day/night lighting (the solar access ports can be shuttered after all) will provide a succession of prime work time day shifts. A trio of villages can be separated by some distance along the inside of a lavatube, with intervening light baffle curtains (where convenient bends in the tube route do not offer the same benefit. Mass transit will unit them, and they can share 24 hour around the clock metropolitan facilities and amenities, including schools and parks and other investments that need to earn their peak full-time, or should we say all-time.

Settling the first lavatube should be part of a well-thought out **Outpost Conversion Strategy**. An initial beachhead outpost is succeeded by a surface Construction Camp once a mature set of feasibility experiments leads to the production of on site building materials. Proper site selection will have taken “graduation” to a nearby lavatube into account as an essential ingredient. Finally, after robot exploration and surveying of the proposed first site, will come the erection of lava-tube village one, village two, a metro complex, and village three. Along with warehousing, farms, and industrial park sections – a whole mini urban complex.



"Transcendental" Needs of Lunan Settlers	
surface sites	lavatube sites
<ul style="list-style-type: none"> <li>• Shielding</li> <li>• Pressure Hull</li> <li>• Biosphere</li> </ul>	<ul style="list-style-type: none"> <li>• Pressure Hull</li> <li>• Biosphere</li> </ul>

## Challenges of Sealing & Pressurization

By Peter Kokh

While the volumes available in lavatubes are comparable in cross-section to space settlement designs, especially that of “Island Two,” they may not be so readily pressurizable. Lavatube walls were not formed as “pressure vessels” and have never been pressurized (except for the possibility of comet puncture and vaporization). Whether they could structurally withstand the expansive stresses of full atmosphere is uncertain. After all, they exist in an ambient vacuum. Deeper lava-tubes will have a better chance of maintaining their integrity, more shallow ones a greater chance of “blowing their lid.”

Even though lunar lavatubes have come down to us intact through nearly four billion years of time, that does not mean that there are no fractures in their surfaces that could let an atmosphere eke out slowly but inexorably. And those tubes with entrances provided by past section collapse (illustration on page 4), will have to be closed off somehow. Those without open-vacuum entrances can be many miles long. That means they suck up enormous volumes of lunar oxygen and terrestrial nitrogen.

Of the three principal lunar-scarce volatiles, necessary for life, Hydrogen, Nitrogen, and Carbon, it is nitrogen that is most deficient on the Moon in comparison to the quantities we would like to have. But even if the import cost were no problem, or if we find cheaper extraterrestrial sources (the rocks of Phobos for example) there is the question of the sealants needed themselves.

We could use microwaves of laser sweeps to glassify the lavatube inner surfaces, making them impervious to gas transmission. But introduce water and humidity and we have a problem. Water attacks glass over time. Epoxy resin coatings could not be processed from known lunar materials, and in the quantities needed would pose an astronomical cost.

But if water seems to be the problem, it may also be the solution. For if we saturate the lavatube with water vapor, no matter to what level we manage to raise the inner surface temperatures in the tube, at some point in the peripheral rock, water vapor will form a rock-saturated frozen seal against further loss. Water vapor may be self-sealing.

But this brings up another problem which, all the denial in the world notwithstanding, affects space settlement designs as well – the likely prevalence of permafrost, a serious challenge to our biospheric and agricultural visions.

Suppose we solve most of these “engineering challenges.” For safety sake, both against possible decompression accidents and biological contamination, we may want to develop a system of sphincters that can pinch shut convenient sections of lavatubes if need ever arises.



Yet the dream of recreating some part of the Earthly paradise is a very strong and persistent and infectious one. In a lot less time than it will take to overcome the challenges of terraforming the Martian surface, we will be able to start terra-forming limited lavatube sections. In contrast to the case on Mars, terraforming the Moon's hidden valleys will work to keep the out-vac surface comparatively pristine. For the Moon's dusty surface which has never known water or air, that is important. An attempt to terraform the surface (it is estimated that an Earth-dense atmosphere would hang around for a few thousand years – and that is practical for human purposes), any such attempt is likely to backfire and create a dust-bowl condition that will last some centuries.

The more modest goal of terraforming lunar lavatubes will be a lot like terraforming O'Neill's Space Settlement structures or Dandridge Cole's hollowed out cigar-shaped asteroids (e.g. Eros).

In H.G. Wells' "First Men on the Moon," we discover a native "Selenite" civilization tucked away in caves within the Moon. The idea is not new, and now it is more timely than ever.

### **GOALS of an early lavatube terraforming experiment program**

We can safely experiment on a small scale, sealing off and pressurizing small sections of tube for transformation into metropolitan centers and village parks. If these special urban facilities failed, it would not interfere with the operation of the rest of the close-pressurized settlement maze.

The next step, tried before we risk pressurizing a whole settlement, might be a lavatube "Natural Park(way)" – Designed as a safety valve and as a bit of Old Earth for those who cannot afford or physiologically risk a trip down the maw-throat of Earth's hexapotent (6x stronger) gravity well, our parkway would be visited and toured, but not open to settlement. Here Lunans could appreciate what they might have missed on Earth, and find themselves renewed and inspired to carry forward the great Lunan experiment. Trial biospheres rich in flora and fauna could be developed without risking would-be residents. A place for honeymooners and lovers and students and retirees – for everyone, The Mecca for Lunans.

Next, a more confident, lesson-learned suite of bio-spheric experiments behind us, we will have the confidence to tackle bigger and better projects. Biospherics could come to Garden Suburbs, whose condo-owners would pay the cost of experimental installations. And why not a tube amusement park?

There is another question here. Creation of a biosphere for our terraformed volume. The go slow experiments above will educate us and give us confidence before we risk citizen lives.

**MMM**

## **MMM # 107 – August 1997**

### **Clear Span Lunar Base Structures**

(SEI & Stafford) by Hugh Kelso, Joe Hopkins, et. al.

We present a design for a lunar base that provides a generic, multipurpose environment; the location of which is not dependent upon natural geological features. Clear-span construction creates large open spaces that can be subdivided according to use and need. It could be developed along the lines of an industrial park with the flexibility to accommodate a wide variety of uses while at the same time providing varied services to its customers.

This design is of steel construction and is divided into upper and lower pressure areas. The upper area provides a pressure environment equivalent to two miles above sea level (9.5 psi) for agricultural use while the lower area provides an atmospheric pressure equivalent to one mile above sea level (12 psi) for habitation and work areas. Elevators which service the base also act as air locks between the pressurized areas.

Our design encloses a space 30 meters high and 50 meters square. A layer of excavated regolith would be spread over the top of the base and compacted to a depth of 10 meters. This would serve as both a shield against radiation and as a dead load to counter balance some of the atmospheric pressure within the base. Other uses for the excavated material might include the extraction of iron, oxygen, and hydrogen. The construction process of the base would be similar to that of a building on Earth, and could be repeated as growth requires.

This base concept permits many interior configurations. Services the base would provide include such things as the basic maintenance of the base itself, power, lighting, air, waste disposal, food, living quarters, recreational areas, communications facilities, computer support, and medical services. Modules could be configured to include fabrication and processing facilities, a gymnasium, park areas, conference rooms, media production studios, and whatever else was needed or desired. Heavy industrial processes, such as smelting, and other activities which may harbor health risks would be carried out in modules separated from those that house personnel. <SLuGS: Seattle LUNar Group Studies>

## MMM #110 – November 1997

[“Xity”: a city that must establish its own biosphere]

# “Reclamation” is a Xity’s Charter Function

## Historical Precursors of Reclamation

By Peter Kokh

There are precursors of reclamation, at least of the con-creation of a settlement’s own eco-niche, scattered throughout human history. In many areas throughout the world and throughout history, areas at first unpromising as settlement sites have been transformed by hardworking pioneers into what are now some of the richest, most fertile lands on Earth.

[As we have remarked before, this is an instance of the unsung Beatitude: “Blessed are the Second Best”, i.e. those unable to compete where life is easy, forced to move to less promising outbacks, left to fall back on their own resourcefulness and to make do with less.”]

River-hugging farming villages have succeeded in greatly expanded their productive farmlands by reclaiming adjacent expanses of desert through irrigation. Similar villages on narrow plateaus or in narrow valleys have done the same by learning to terrace the surrounding mountain slopes, thus reclaiming them from barren non-productivity.

In the Netherlands, the Dutch have learned to build dikes to tame the tides, then to drain the backwaters and establish fertile non-saline farmlands, called polders\*. And so they have reclaimed relatively worthless sea bottom and tidal flats. The dike is the analog of the pressure hull, the polder of the modular (or, someday, monolithic) hullplex that contains the settlement’s biosphere. For the Dutch, this ongoing annexation of turf, formerly surf, has continued for centuries. To live is to grow is to keep reclaiming ever more wasteland and transforming it.

The great dike that created the fresh water Zuider Zee from the once saline IJsselmer, a bay of the North Sea, is like a giant sun-shading ramada, in that it creates lee space within whose shelter, reclamation can proceed at an even faster pace. The peat mined from the freshly reclaimed sea bottom lands prefigures the solar wind gases to be scavenged from the lunar regolith during site preparation, building materials processing and construction.

Nor do the Dutch toil just to increase their annexed farmlands, they toil to maintain them, even as space pioneers will have to do. Maintenance and growth have to proceed hand in hand. Eco-niche lands won from the sea bottoms, whether of oceans or of space, must be

defended ever after. Life always strives against entropy. Rest is fatal. Reclamation is the life of the desert oasis, of the mountain-terrace farming villages, of surface settlements on worlds not blessed with oxygen-sweet atmospheres.

[More on the Polder Analog: MMM #38 SEP '89 pp. 10-13 "Polders: A Space Colony Model", by Marcia W. Buxton.]

Because of this "charter burden" these precursor settlements on Earth might aptly be called "xities" (in so far as they are at least biosphere-challenged in comparison to other, at first glance, more propitiously sited towns). And that should give us all comfort and encouragement, we who would establish "xities" beyond Earth's biosphere altogether, not just beyond its more fertile reaches. There is precedent. We have spiritual ancestors. Their success gives us models to follow. We are not alone. What we would do emerges as a natural extension of what the best of men have tried and succeeded in doing before us.

It is the Epic of Life, in which the hero thread continues to be carried by the Second Blessed. We who find ourselves stifled and hamstrung on Earth where life is easy, it is we who hear the call to pioneer where life must be unimaginably harder, where left to our own resourcefulness, we have a chance of living a life more satisfying than any we could hope to live here in any of the genteel soft-edged Baltimores of Old Earth.

Space pioneers will learn to reclaim the sea bottoms of space, i.e. the vacuum-washed surfaces of barren worlds like the Moon, annexing areas bit by bit into growing pressurized modular mazes. Herein they will not have simply enhanced a local portion of a given common biosphere, but created a biosphere from scratch, where not even the seeds of one existed beforehand. As the settlement grows, as more and more of the space sea washed surface is incorporated into it, won from the sterile vacuum and turned into verdant farms and luxuriantly green villages, the infant biosphere will grow in mass, in reserves, in diversity, in resiliency, and in the satisfactions of life it affords its toiling inhabitants. Reclamation is the xity's job, and the xity will thrive as long as it continues to pursue this goal.

Under the aegis of "reclamation" will fall all the major manpower using tasks of the Xity, at least in an oversight capacity: new expansive construction, using export production byproducts for that purpose, pressurization maintenance and repairs, air and water recycling and refreshing, and the food cycle that is part and parcel of those two tasks. It is the indivisibility of its biosphere that gives the xity a charter monopoly on these reclamation tasks.

Reclamation is appropriate in all parts of the Solar System beyond Earth's sweet atmosphere, in free space itself, on Mars and among the asteroids, on Europa and Titan, and wherever human resourcefulness will find a way to establish viable biospheres in which we can live and grow.

Perhaps many a reader has found the name of our society esoteric: The Lunar Reclamation Society. But if "Communities Beyond Earth" are our common goal, then it should now be clear that LRS is right on target in defining the challenges.

<MMM / LRS>

**MMM #111 - December 1997**

## **Lunar Skyscrapers**

*Shattering Low Expectations*

By Peter Kokh

[see MMM # 55 MAY '92, pp. 5-6,

### An envelope-bursting topic revisited

The conventional wisdom is that surface-embedded or surface-burrowing lunar settlements will be monotonous complexes of "mole hills" unrelieved except by docking ports, communications antennae and other systems hardware that must be on the surface or surface-exposed. Yes, we have all seen science fiction artist renderings of skyscraper studded lunar and Martian cities on great glass domes. But that is an eventuality for realization somewhat further down the road, if ever. And as to settlements within lunar lavatubes, some with ceiling heights a thousand feet high or more – why, what we'll have there, are ceiling-scrappers (or even ceiling-touchers). In both these cases within pressurized megastructures, the first man-made, the second provided by nature), the skyscrapers are likely to be conventional copies of what is current construction structure and form on Earth.

But what excited me when I wrote the first article five and a half years ago, was the realization that the starter premise just wasn't necessarily true. We could build fully shielded "skyscrapers" to centralize the downtowns of lunar settlements built the way settlements on Old Earth always have been, the old fashioned way, one structure at a time.

### The "Pent Roof" makes it possible

Egyptian pyramids, Mesopotamian ziggurats, and the Tower of Babel notwithstanding, the practical skyscraper was an urban innovation that awaited two inventions: the steel girder, and more importantly, the first people mover – the elevator. (Yes, we know the Russians have built high rises without elevators, so, what's your point?)

For anyone imagineering a lunar surface settlement cozily tucked under its regolith security blanket for protection from the local cosmic weather and for thermal averaging, the idea of a skyscraper-studded "downtown" just did not occur. How would you shield something like that?



Enter by happenstance, a picture of a Chinese pagoda in some book I was perusing, and a eureka brainstorming avalanche was on its way cascading down the brainslopes of my mind.

A little redesign slight of hand with those pent roofs (pent as in penthouse), and they could serve as overhanging retainers that could hold a couple of meters of lunar regolith shielding – not prohibitively heavy in the light lunar "sixth-weight."

For people on the Moon for long duration or indefinite stays, it is important to be very, very conservative in minimizing accumulative radiation exposure. "Windows" providing the satisfaction of regular views out onto the local moonscape should incorporate broken pathways, using mirrors, so that the observer is protected in every direction by adequate shielding, so that the habitat or moon manor has not "hot spots". The same is true of any type of structure in which people regularly work or spend significant accumulative time.

In comparison, the "pent roof" balcony overhangs would provide safely set back vertically narrow eye level slit windows, and through them, horizontally constrained views of the moonscape. Looking out through one of these, the observer would see just enough "sky" to frame the view, a sky with very few square degrees of exposure to the naked cosmic heavens and its hot delights.

If you wanted to build a pentroofed office building, you would have to tweak the internal layout so that the interior space sporting these view ports was reserved for use principally by visitors, and, compromisingly, for regular office personnel and daily maintenance staff people "on break". The principal break room and lounge areas, however, would be in interior parts of the building that did not sport such direct-view windows). In other words, lunar office towers

would have such slit windows only here or there. The architect could always resort to rows of fake trompe l'oeil windows to create the right external effect. After all, the architect has two goals in mind: an optimum, occupant / user-friendly interior arrangement, with a full suite of desirable function areas; and, a pleasing, readily identified, and positive image-creating external appearance on display for the potential using public passing by.

Such pent roof windows might be used with more abandon in buildings more heavily used by visitors, such as the Luna City Hotel. Even so, for the protection of guest room cleaning staff especially, the architect would want to tweak the internal room layout to minimize the total accumulative fraction of daily time spent in the hot spot pools of naked sky exposure. And hotel management will be constrained by law to rotate staff duties to minimize the chances of anyone getting too much accumulative exposure.

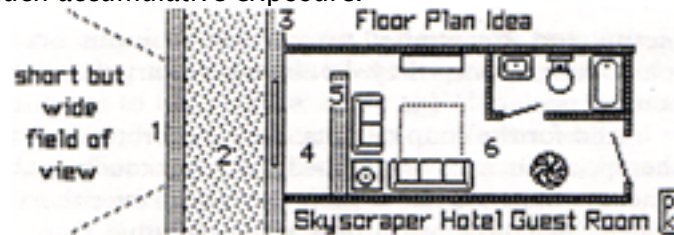

KEY: (1) Outer pent roof retaining wall; (2) shielding; (3) Hotel "Hull" wall, with narrow, high, window slit; (4) Interior, shielded, viewing "balcony"; (5) interior "shielding partition"; (6) Guest Room proper

### A Second Look

In that article we looked at three possibilities: (a) single or multiple vertical cylinders with pagoda like pentroof balconies holding shielding mass, yet which allowed vertically narrow views of the surroundings; (b) Stagger-stacked horizontal cylinders, again with pentroof shielded and windows; (c) a circular pyramid of horizontal cylinder sections of decreasing diameters.

In retrospect, this last design option seems the most strained. Pressurization stresses would make it the most likely to fail. This article offers a radical rethinking of the round pyramid format.

Instead of stacked cylinder sections of decreasing diameter, we now propose stacked torus units of decreasing outer diameter, but of set inner diameter (of the donut hole). And they would be stacked over and around a vertical cylinder which would carry the elevator shaft and service chases for electricity, communications, thermal control, and plumbing. If this seems reminiscent of a popular children's building block toy, it is with reason. Here lies the humble source of our inspiration.

In the design shown below, for illustration purposes only, the upper torus tier would be sized to include floor to ceiling clearance for one floor, The next tier, two floors, the bottom tier three floors. The exposed roof overhang of each torus would be covered with shielding, pentroof style, as illustrated in the previous article, partial pent balconies at each intermediate floor level. Not a very visually pleasing design, however structurally sound.

One possible building top embellishment is a geodesic dome or hydroshield dome (a Marshall Savage idea) serving as an observation area, the later much better shielded. Another obvious topper option is a service core shaft extension to a revolving rooftop restaurant, à la the Space Needle in Seattle (just the first of many copycat structures now highlighting downtown skylines around the world). With possible structures like these, the analogy of the downtown centered Earth city is wonderfully translated into the construction idiom of incrementally growing regolith blanket shielded lunar, or Martian, surface settlements. Marketable uses are for bank office buildings, corporate headquarters, and hotels.

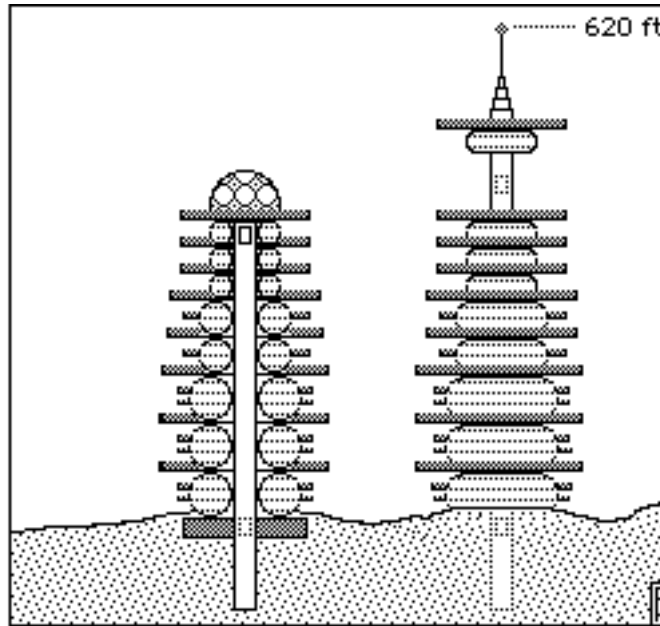

KEY: (left ) see-thru observation dome skyscraper  
 (right) outside view of twin tower with revolving restaurant. Both have 23 occupiable floors.

**From Pent Roof To Caisson**

The illustration effort above yielded rather ugly results. The important thing about the torus - central shaft stack is its dynamic stability pressurization-wise. Why not, for this application, shuck the pent roofs for cylindrical caisson sections holding shielding up against the building. These bulkheads would not be pressurized and can be vertically flat.

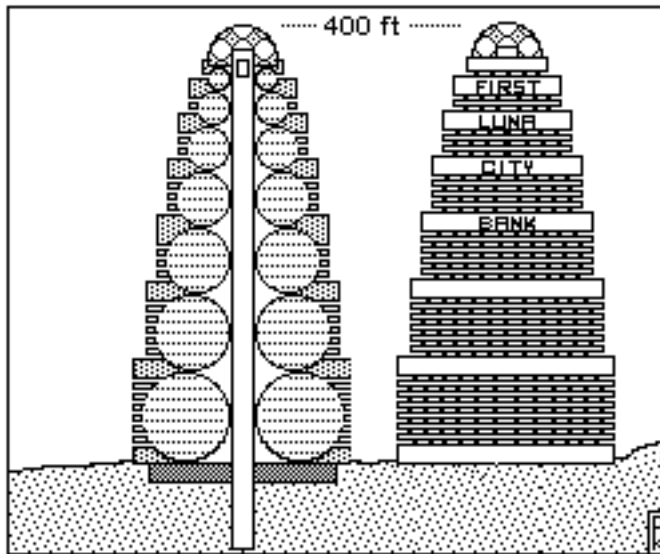

This results in a much more conventional look. These are some ideas thrown out for improvement. We'd like to see now good artist renderings of a downtown-centered lunar urban panorama. <MMM>

# a Approach to Biospherics

## A Modular Approach to Biospherics – Designing every Occupation Unit as an EcoCell

By Peter Kokh

Moving off planet (Earth) is much more than a matter of engineering cheap transportation to space. It means moving out of the Biosphere that envelopes and involves Earth's global surface layers (air, the land, soil, water) and everything in them. It means moving to an area, whether in free space or on the surface of other bodies in the solar system, where we must create biospheres from scratch to live within.

Even the problem of “designing” “stable” minibiospheres seems quite daunting, discouragingly replete with too many parameters to be taken into consideration. The globally followed Biosphere II experiments in Oracle, Arizona were widely reported and still believed to be a failure. Such an attitude angers us and fills us with contempt at those who report or parrot such conclusions. First, nothing is a failure from which lessons are learned. Second, there is no other path to success than a pyramid of so-called “failures”.

But what we did learn from Biosphere II is that finding a successful “equation” is much more challenging a problem than we had hoped it would be. We suggest that that is because we are going at the problem from the top, looking for a centralized solution or equation, rather than from the bottom. In nature, everything works from the bottom up. This means, of course, laying foundations, a step many people hope to avoid, in their impatience for results, in whatever endeavor they embark upon.

That looking for a central topdown equation for a stable self-maintaining biosphere should be an effort doomed to failure, should be self evident. If a solution were to be found, it could only be a “point” solution, a point in time at which just so many factors were in play: x number of species x', y number of species y', z numbers of species z' – and on and on for all the plant and animal and microbial species involves – and for the number of the human population included – and for the land area and air volumes of the biosphere etc. Now what good is a static solution for elements that can never be in stasis but always jockeying for position, as living ecosystems do?

That biospheres cannot be successfully designed from the top down should be no more surprising than that economies can not be so designed, much to the chagrin of those who persist in trying. Nature, it seems, is as democratic as economics. Perhaps, we should start from the bottom.

### HUMAN OCCUPATION UNITS – THE SPECIAL CASE

In Einstein's theory of relativity, the “special case” was much easier to formulate than the “general theory”, preceding it in publication by some nine years, I believe. Similarly, we are here taking a look at one element in the biosphere, but an all-important one, human occupation units. Because these will ever be growing in number, and the volume and mass of the biosphere with it, and because they create the greatest stress on any would-be “equilibrium”, the problem occupation units pose is a paramount one. Coming up with an approach that greatly aids towards a “general theory of modular biospherics” would be an important first step.

By **Occupation Unit**, we mean any structure that houses sustained or intermittent human activity of any type that requires a toilet. – living units (homes, apartments, hotel units), places of work (factories, laboratories, offices, schools, stores and shops, etc.), and places of play (theaters, parks, playgrounds, sports facilities, etc.). Why is this important? Because the toilet is the point-source of one very significant demand on the biosphere's ability to recycle and sustain itself. If, as on Earth, we ignore the problem at the source, and shove it off on



central water purification facilities, we make the problem and challenge of biospheric stability and self-maintenance enormously more difficult. If, on the other hand, we tackle this problem at the source, in every occupation unit in which there is a toilet, then the aggregate problem needing to be addressed on a centralized or regional basis is greatly reduced.

### **THE INDOOR GRAYWATER SYSTEM**

Several months ago, while convalescing with my shattered leg, I was watching one of our PBS channels on a Sunday afternoon and happened to take in an episode of “New Garden” that told about the unique “Indoor Graywater System” of retired NASA environmental engineer, Bill Wolverton. In the 70s, while working for a NASA that expected to put colonies on the Moon and Mars, Wolverton came up with a system that treats 95% of the problem of human wastes at the source, i.e. within each home or occupation unit. Each toilet feeds a long row of planters that accept the waste as nourishment, and in payment, not only remove 95% of the “pollutants” before the residue water exits to the exterior, but renews and freshens the indoor air, and provides an ambiance of luxuriant greenery. The planter sections adjacent to the toilet are planted with swamp varieties, then come marsh plants, bog plants, finally regular soil plants. The plants are content with low light levels – much less than full sunlight.

Wolverton’s system has been operating in his Houston home successfully with no problems for over twenty years. While he invented this to meet then projected NASA needs on a since abandoned space frontier, he continues to work on adapting it to terrestrial needs. For examples, his planter “soil” is extended with “popped” clay pellets that are light weight so that his systems could be used throughout high rise buildings, providing fresh air, the ambiance of greenery, and precleaning the waste water, without adding undue weight loads, floor by floor.

Wolverton’s system runs along the periphery of his home, to make use of ambient direct and indirect sunlight through rows of windows. Artificial light could be used. How could this translate to lunar and Martian or other extra-terrestrial applications?

In the case of surface-burrowed settlements, sunlight can easily be brought in by heliostats or fiber optics, making use of coatings to leave most of the heat outdoors. We have written about such possibilities on several occasions. A modular lunar home, office, lab, shop, or whatever, using filtered dayspan sunlight, and artificial light intermittently through the two week long nightspans, could be combined with Wolverton’s indoor graywater system to produce a home or occupation unit in which it would be a delight to live, work, or play: full of sunshine, greenery, fresh air – the perfect counter-point to the alien, barren, sterile, hostile environment out on the surface itself.

In lunar or Martian lavatubes, artificial light, of wavelengths close to that of sunlight, would have to be substituted. On Mars, where sunlight is only half the intensity of that available on the Moon or on Earth, less filtering would be needed for surface-burrowed installations.

What such a system gets us, applied without exception across the board, is considerable. Each occupation unit becomes in effect a functioning cell of the minibiosphere, something much more than an inorganic construct of building materials. Each home or working unit now becomes an organic system as well as an inorganic one (of pressure hull with electricity, temperature controls, and plumbing). In such a system, we begin to look on the home or occupation unit in a whole new light – not as a foreign intruder in the biosphere that imposes an uncompensated burden, but as a place to live and work that is itself an integral functioning part of the biosphere. The indoor graywater system not only greatly reduces the environmental impact of each occupation unit, it contributes biomass and helps recycle the air, as well as the water, locally. The home or occupation unit thus becomes a responsible citizen of the minibiosphere. Further, the effect of such a system is to make all homes and occupation units much more delightful places to live – an incalculable plus on the space frontier where so much that mentally and psychologically sustains us on Earth – where we take nature and the biosphere for granted – has to be given up. Here is a living unit with a mission, a mission that works.

As we advertised, this is a “special case” start towards a whole new “modular” approach to biospherics, and approach in which we try to minimize the environmental impact of each



element, natural or post-human, by addressing it at the source. This minimizes the residual problems that require regional or central solutions.

The modular approach to biospherics makes sense, because it lends itself to human communities, and their coupled minibiospheres, that can and will grow, naturally, as their economies warrant, addition by addition. Centralized biosphere planning may be narcotically attractive to those who would mega-plan topdown large fixed size settlements such as O'Neill colonies or all-under-one-dome surface cities. But such places, at first underpopulated, briefly populated just right, and then forever after overpopulated are fairy tale dream puffs that cannot deliver the idyllic livable picture postcard environments that artist illustrators have many accepting as the goal.

Modular biospherics is not only a better approach, it is the only approach that can work. Designing frontier homes and occupation units as living EcoCells is a big down payment in the right direction.

<MMM>

Order "Show # 707 Indoor Graywater System" from New Garden, New Braunfels, Texas for \$24.95 - allow six to eight weeks for delivery.

## MMM #120 - November 1998

### **In Focus: Essence of the Frontier: "Readiness to Reinvent Everything"**

Commentary by Peter Kokh

Throughout human history, whenever groups of people endeavored to pioneer new territory, unoccupied or not, they have had to adjust to different conditions than those they were familiar with in their traditional homeland. When there was a choice of prospective new territories, they would, of course, naturally select those that seemed most similar to the one left behind, at least in those respects that mattered most. Steppe peoples favored other steps. River delta people, other river deltas. They would have to make some adjustments, but hopefully not wholesale ones. But nowhere could they expect to find a new home just like the old one in every way. Whether the stress was on finding a new life setting, or on getting out of the old one, except in the case of unwilling refugees, the movers were a group self-selected according to their willingness to start over, their acceptance of the need to "reinvent" many of the givens of daily life to fit the character and available assets of the new home.

Mineral resources, wildlife, vegetation, and climate all affect what the pioneers can make and the methods they might use. On hand manufacturing and craft stuffs will affect home and building styles and construction methods, furnishings, clothing. Sports, games and amusements, even cuisine, will show major or minor adjustment to the new realities.

Those who liked their lives as they were and were willing to change little, stayed behind. Those who left would naturally change as little as possible, but were willing to change and adapt and make do whenever, wherever necessary. As we move into space locations, we are very unlikely to find any places reminiscent of Earth except in trivial ways (the Arizonesque scenery and similar day/night cycle of Mars).

Those not ready to make major and wholesale adaptations will chicken out once they take off their rose-colored glasses. Sure, we've all seen the very Earthlike concave landscapes painted by artist dreamers trying to sell the L5 vision. But if ever such places are built, it may be long after the youngest of us is dead that the extremely high economic thresholds involved are reached. Nearer term, whether on or under the lunar or Martian surface, or in the primitive shielded construction shack space settlements that we might be able to build in coming generations, the frontier's most Earthlike aspect will be ourselves, the plants and animals we bring along, and our characteristic "we can do it" attitude.

Those who find they have to leave behind too many “favorite things” and lack confidence that they can find/make satisfying substitute “favorite things” will choose to remain behind. Never has there been a frontier, or set of them, so challenging, so demanding of our readiness to reinvent everything. It is a task that daunts us, whether we’d go to the Moon, to Mars, to the asteroids, or pioneer the first crude space settlements. There will be a premium on adaptability and attitude. The tasks involved should frighten anyone taking a real look.

Yet there are ways to adapt, to do without, to make happy substitutions. There are ways to hone the rough edges off the early frontier. Taking a look at them, one by one, is just what MMM is all about. That is what the third “M” is all about. A brash, brazen **MANIFESTO** that shouts: “look, we can do it, and these are some of the things we might try to make ourselves ‘at home’ in our new setting.”

If we remain displaced Earthers, we will have failed. We will need to redefine ourselves as fully settled-in Lunans, Martians, L5ers, asteroid ‘Belters’ and so on. We can only do this if we leave Earth behind in our psychological rear view mirrors, and forge unreserved new attachments to our new homes. We need a no-holds-barred readiness to reinvent everything. Sure, some material, cultural, and social aspects of our lives will translate readily enough. But others will require major changes, reinvention, replacement, or sublimation.

If the Frontier is a place where we are forced to start anew, it is also a place where we will have a chance to get in on the ground floor, a greater chance to play a significant life role, where we can leave behind the baggage of examples, customs, habits, and strictures accumulated on Earth. The space frontier will be a rugged place where the status quo, the way we do things, is not a given, but something to be created afresh with our input. And all this is a plus. It is this gain in the potential value and significance of our individual struggles that will make all the sacrifices worth while. It is this promise, the chance to start over when the old life has been found wanting or become unbearable, that has been the beacon, the siren, the beatific vision pulling many a person and family to pioneer in the past.

The deep logistical mutual quarantine of the various space frontier sites will offer unparalleled opportunity for social, political, cultural and religious experimentation without attrition to, and erosion by, a dominant and overwhelming mainstream culture. It is not only political, cultural and eco-nomic anarchists and utopians that will be drawn outwards, but many individuals with more concrete, more personal problems with their current life situations. The frontier will be an unparalleled scene of renaissance, creativity, fulfillment. **PK**

## MMM #122 - February 1999

### Shielding Accessories to Jump-start Lunar Industry

The first lunar outposts, and the first facilities at any subsequent site, even at a lavatube site, will surely be surface ones, requiring shielding from cosmic radiation, micrometeorites, thermal extremes, and solar flares. The first lunar construction “trade” will be shielding emplacement, with accompanying design architectures. In this issue, we delve into some of the options early “moon roofing” contractors may consider. See just below.

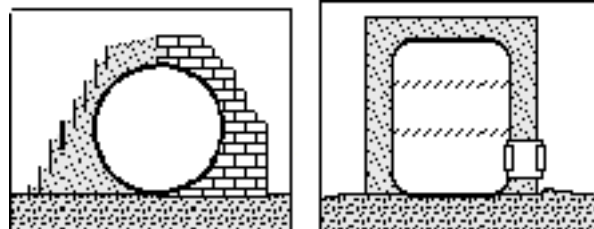



SHIELDING: the “B” Options By Peter Kokh

Everywhere in the universe, not blanketed by a thick atmosphere of some kind, must be shielded from cosmic radiation incoming from all directions, from every point in the sky. Depending on where we settle, we may also need shielding to protect from solar flares, micrometeorite “rain”, and extremes of hot and cold temperatures. Shielding is “Job One” on the Moon, in free space, among the asteroids, on space ships on long journeys – and, yes, even for Mars.

Decisions on how we are going to shield the first Moonbase, its expansion units, and subsequent installations on the Moon (or on Mars) have received a lot of attention – but not enough. This is a nonpostponable task. Some options are nearer term in the sense of requiring less capital equipment and/or less man hours exposed out on the surface. Others are longer term, in the sense of being enabled by early lunar (or Martian) industries.

We have looked at the question more than once, and the reader is referred to these past articles, by myself, unless otherwise indicated:

MMM # 1 DEC ‘86, p 2, “M is for Mole”; MMM # 5 MAY ‘87 “Weather” republished in MMM C #1

MMM # 25 MAY ‘89, p 4, “Lava Tubes”; republished in MMM C #3

MMM # 37 JUL ‘90, p 3, “Ramadas” republished in MMM C #4

MMM # 55 MAY ‘92, p 7, “Moon Roofs” republished in MMM C #6

MMM # 74 APR ‘94, p 4 “Shielding & Shelter” republished in MMM C #8

MMM # 89 OCT ‘95, pp 3–4. “Shelter on the Moon: ‘Digging-in’ for Longer, Safer Stays”,

P. Kokh

republished in

MMM C #9 MMM # 94 APR ‘96, p 14. “Shielding Artemis Moonbase”, Greg Bennett

republished in MMM C #10

**INTRODUCTION – THE “A” OPTION**

This is simple: we ‘plop’ a ready made habitat on some level ground, and then scoop or drag up regolith and pile it up against the sides and over the top. There have been many suggestions how to accomplish this: some rely upon onsite manpower, some rely on remote manpower, teleoperation from Earth, some would involve automatic or robotic equipment. In all cases, the idea is to minimize the mass of equipment needed, not necessarily to get the job done faster.

“Option A” has some serious shortcomings. Piled shielding is crude in shape, defying attempts at design and style. More to the point, it makes add-on expansion difficult, as some

of the amorphous hard-to-handle shielding mass has to be “removed”, and the existing structures “dusted off” to enable pressurized connections to the new expansion units.

### A BEVY OF ‘ B’ OPTIONS

One way I’ve frequently used to brainstorm multiple approaches to a topic or theme is to browse through the dictionary, often just one letter section, and see how many words evoke a fresh insight. In this case, I could have used any letter, but since “bags & bricks” have been the hot item on one of the Artemis mail lists brainstorming Moonbase options, I chose the “B” section of a dictionary. Here are the results, upon which I have tried to impose some sort of order.

#### **Beneficiation** (“Primaged” Regolith)

The first improvement I’d strongly suggest to the point of insisting upon, is that any regolith to be moved in grading the site and/or subsequent covering of habitat hulls be first “primaged” or mined for its volatile gas content (hydrogen, helium, neon, argon, nitrogen, carbon) with which it has been enriched through eons of buffeting by the solar wind. This can be done by simple heating. In the same handling, the regolith can be mined for free (unoxidized) iron fines by passing it under a magnet. While this will only minimally “improve” shielding quality (removal of iron fines will reduce any secondary radiation), the real purpose is to put in place a “habit” that will provide feedstocks for a whole suite of useful lunar industries. See MMM #38 SEP ‘90, p 4, “Introductory Concepts of Regolith Primage”, [republished in MMM C #9]

This said, here are some simple “B” Options that do not otherwise require on site industry. As such they might be considered for initial beachhead emplacement.

**Bi-Hull designs** incorporate a fillable hollow space in the package assembled on Earth. Neat and convenient, allowing “clean & easy” external hookups, but could take up precious cargo bay / hold space unless a special faring was used. The weight penalty would be real but not necessarily major. Lunar regolith would be poured through topside openings on site.

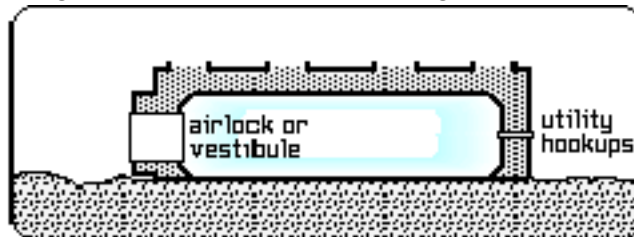

**Bags (saddle-)** use the same ready to fill concept, but address the weight and cargo bay space penalties by using a durable fabric that hugs the hull during shipping instead of a fixed metal outer shell. Such a “bi-hull” concept would work particularly well with multistory vertical cylinder habitats that would otherwise be very hard to shield. A fabric outer hull could be kept in place by periodic ties.

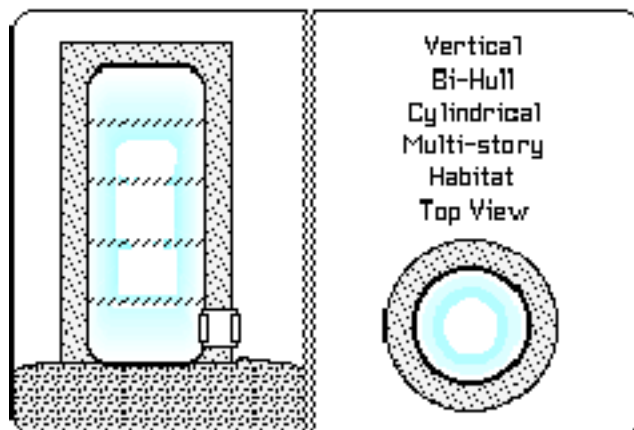

**Boulder Banks** – In many farmland areas, you may have seen rows of piled up stones and boulders that serve as fences. These were removed from adjacent fields during initial plowing. In similar fashion, boulders and rocks removed from a site in grading, could be used as “retaining walls” in shielding.

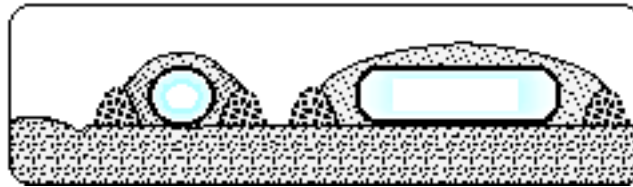

**Bowls** (craters) Using the rims of small craters to impound the regolith shielding might seem to be a good idea. But the ratio of rim-over-floor height to width offers little advantage over flat sites.

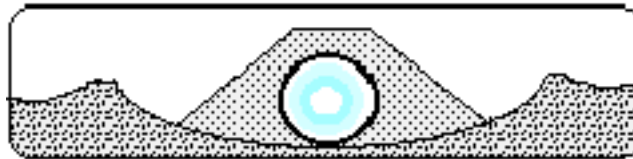

However, a sized-right crater bowl might be ideal for deployment of an inflatable torus habitat.

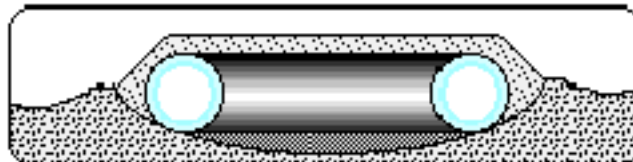

Or, better yet, a multi ring torus outpost, so designed as to use up most of the “donut hole”. The idea is to design the habitat complex to take full advantage of the site.

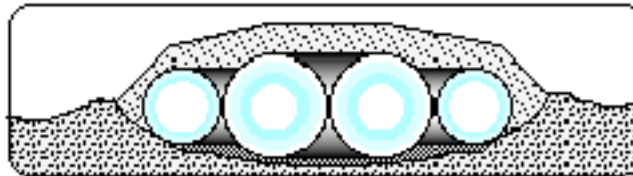

**BETA-SHIELDING** – We can make major improvements to shielding structures by using regolith in conjunction with various products made from materials that have been extracted from it, e.g. iron, ceramic, glass.

Principal significant design advantages to be gained are:

- reducing footprint of the shielded structure so that neighboring structures can be clustered more closely
- making expansion hookups (connection to new units) easier

These goals can be better achieved to one degree or another in several ways:

- vertical retaining walls that incorporate hookup service runs
- containerized removable shielding along vectors of projected expansion
- creating bays of “lee” vacuum, protected from cosmic rays, solar flares, and the micrometeorite rain, through construction of hanger space under which unspecified habitat and lab modules can later be placed and hooked up to one another without the nuisance of “contact” shielding.

Some of the accessory items required might be remotely tele-manufactured on site (along with piles of pre-primaged regolith) prior to arrival of the outpost erection crews. The equipment required for such manufacturing would kickoff lunar industry.

**Baffled, Benched Berms** – Regolith can be bermed in steeper slopes if retainer “risers” made of iron, glass, or ceramic are added to ‘staircase’ the berm. These embedded “risers” act as caissons. This will reduce the site footprint and allow closer positioning of additional modules added at a later date.

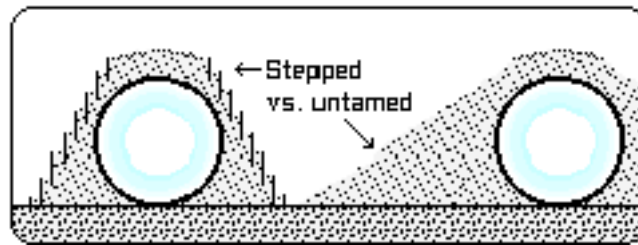

**Bags** – Lightweight but durable sack-bags brought from Earth, or made on the site of felted glass fibers, can be filled with regolith and piled sandbag fashion around the habitat module(s). The advantages would be twofold: steeper slopes and easy disassembly to allow clean connections to expansion modules.

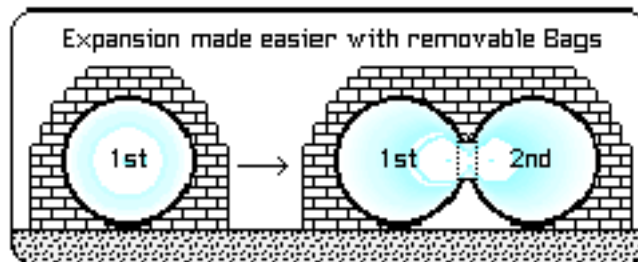

**Batts** – Elongated bags, reduce the number of shielding units to be handled. Or could we manufacture local fiberglass batts in such a way that impregnated them with densifying regolith powder, making them easier to handle and rehandle?

**Bricks & Blocks** These would stack the same way as sackbags, but would have two advantages: no bags to break and therefore less fragile, and no bags to bring from Earth or make of less than durable materials on site. Brick-blocks could be turned out by vibration-tamping regolith in a slip mold while sintering the surfaces with solar heat or microwaves. All that would be required is a few molds and an automated assembly line process that would end in a stacked stockpile, ready to restack around the base modules when the crew arrives. The challenge of both bags and brick-blocks is to find ways to keep out-vac man-hours (crew exposure time) to a minimum.

**Braces & Buttresses** – A retaining wall of sheet iron could be held in place with braces or buttresses dug into the surface.

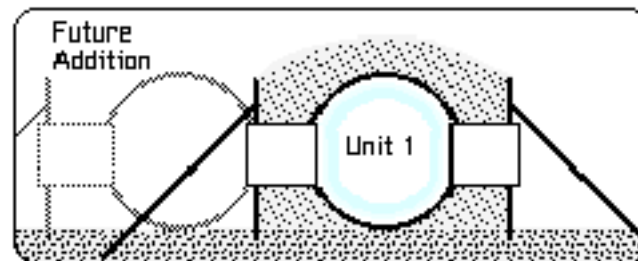

**Bayed caissons** – An unanchored caisson wall could be held in place by using bayed sections, concave to the outside. This is best illustrated in a plan (top view). The individual concave/convex panels could be made of crude cast iron.



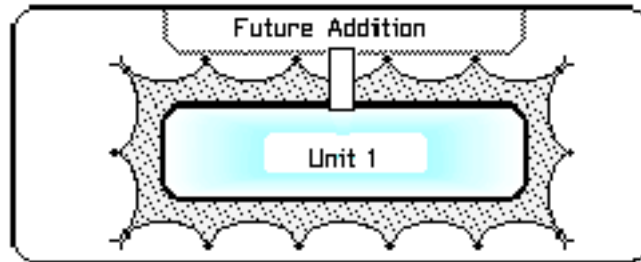

**Beehive caisson** – A Caisson could be built in a hexagon pattern with the leads serving as buttresses. This would favor circular designs for the habitat module or complex within, e.g. a vertical cylinder or perhaps a torus – a rather restrictive architectural choice.

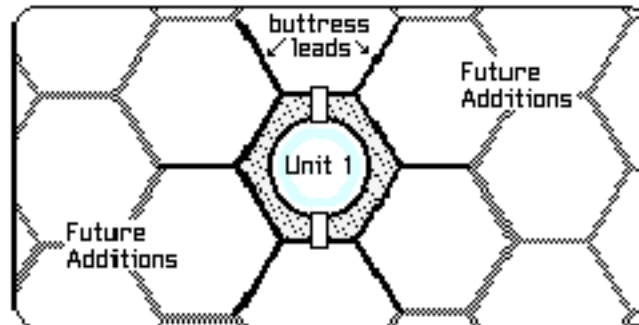

**Belted caisson** – A cable-belted circular caisson may look like a Mongolian “Yurt” or a Navaho “Hogan.”

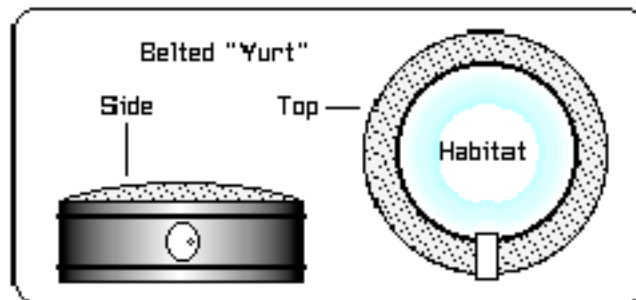

**Barrels, Bins & Bottles** – Open-topped bins filled with regolith could be stacked and unstacked in like manner. Bins could be made on site of ceramic or of sintered iron fines. They would only have to stand up to being handles 2–3 times. Bins of crude fused glass (or cubic bottles, if you will) are another possibility. Empty barrels from Earth that had no better reuse (that does seem rather unlikely) would serve as well.

**Bunkers** – Various structures (Hangers, wide bridges over rille sections, etc.) designed to provide non-contact shielding in the form of “lee” space, spacious bays of vacuum protected from the cosmic elements. In such protected preshielded space, a wide variety of habitat complexes can be built with considerable convenience and freedom within the height clearance provided and overall footprint of the shielded surface.

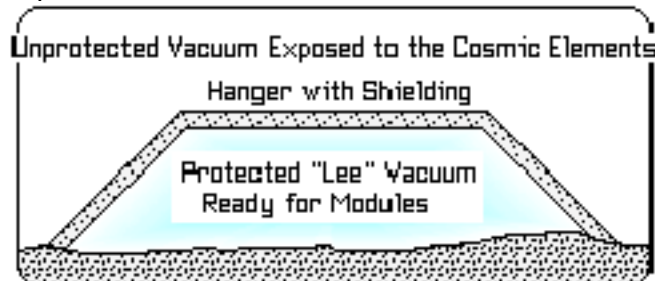

We covered such options and designs at length in MMM # 89 OCT '95, pp 3–4. “Shelter on the Moon: ‘Diggingin’ for Longer, Safer Stays”, by Peter Kokh. [republished in MMM C #9]

**Beam & Post** – A structural system by which bunkers or hangers might be built of iron or glass composite. Later on, aluminum, steel, titanium or magnesium could see service. Sheet metal or panels of fiberglass reinforced glass panes could be affixed to this skeletal structure and regolith shielding deposited on top, creating an artificial space analogous to that provided by lavatubes, but smaller in scale.

**CONCLUSION** – These “**B Options**” likely just touch the realm of possibilities. It is clear, however, that if we are look beyond a one-shot lunar outpost installation with no provision for growth, that architectural accessories for more convenient and flexible placement of regolith shielding will be one consideration in choosing early lunar startup industries. <MMM>

## MMM #125 – May 1999

# A Levittown on the Moon

## First Construction and a Look 50 Years Later

[How it could be built soon on the cheap and how it would evolve from canned uniform housing to a highly personalized settlement.]

By Peter Kokh

Granted, most people who see a human future on the Moon, don’t see much beyond a science outpost of a few to a few hundred people at best. All attempts to fly a one-product lunar economy have failed, of course, and only serve to demonstrate the economic density of those who have promoted them.

### A Diversified Lunar Economy

On Earth, the only “viable” economies are diversified ones. Why should it be any different out there? Given that 90% of most national economies involve production for local consumption, and that exports are needed principally to pay for importing items that cannot yet be produced competitively at home, the three things we need to consider are:

1. Local production of as much total product mass as possible intended for local consumption: housing, furnishings, storage, infrastructure items, food, etc. For this end, they have to maximize what they can do with concrete, ceramics, steel, other lunar alloys, glass and glass composites.
2. Finding external markets for the same or similar items: in short, anything Lunans can produce for themselves, should be marketable to any other “space market” (installations in LEO, L4 or L5, outfitters for Mars expeditions) at a competitive advantage of equivalent items shipped up Earth’s deep fuel-sucking gravity well.
3. Producing products and services specifically for external markets

### Inflationary Population Growth

On this basis, economic break-even should be possible, but only if the Lunar population grows as fast as possible. What Lunans will be able to produce for themselves at any given time will depend on the size of the labor pool. The more hesitation there is in population expansion, the slower will be the progress towards economic self-sufficiency, and the more prolonged the period of economic vulnerability during which the young settlement risks unrecoverable failure. Lunar settlement will not be for cautious conservative temperaments, but a “do or die” affair.

### Constraints on Building Lunar Housing



The greatest product demand by far will be for expansion housing and shelter. The need to use manpower as efficiently as possible means that a properly designed modular housing system will be one that requires an absolute minimum of man hours to put in place and pressurize. Once that stage is

reached, enterprising settlers are free to spend a lifetime of after-hours free time finishing the interiors in a fashion that expresses their talents and personalities. There will be a considerable "after-market" demand for part time artists and craftsmen on the Moon.

### **Aspects of Lunar Architecture & Construction**

We have spoken about Lunar Architecture before and recommend rereading the following articles

- MMM #5 May '87 "Lunar Architecture"
- MMM #75 May '94 "Lunar Appropriate Modular Architecture"

In the second article, we defined a "Lunar Appropriate" Modular Architecture as incorporating these six elements:

1. The smallest number of distinct elements
2. The greatest layout design versatility
3. The most diverse interior decorating options
4. Fabricated with the least labor and equipment
5. Assembled with the least EVA and equipment
6. Pressurizable after the least total crew hours

In the same article in MMM #75, we introduced the concept of the lunar "Great Home".

### **Size of Lunar Homes – the "Great Home" Concept**

We must resolutely and brazenly set aside the notion that lunar settlers shall be forever condemned to endure life in cramped quarters. As long as pre-built shelter must be brought in from Earth, weight limits will work to keep pressurized space at a high premium. Fortunately, by the incorporation of inflatable elbowroom in early expansion phases especially for shared communal functions, "cabin-fever" can be kept at bay.

But once simply and cheaply and easily manufactured housing modules have been designed that incorporate local lunar materials almost exclusively, valid reasons for pioneers to continue accepting constrictive personal quarters evaporate.

If it can be achieved within the labor and productivity budgets of the settlement, there is no reason why lunar settlers should not request and receive homes that are spacious by American standards. Indeed, there are good reasons to err in the opposite direction.

First, considering that lunar shelter must be overburdened with 2–4 meters of radiation-absorbing soil, and that vacuum surrounds the home, expansion at a later date will be considerably more expensive and difficult than routine expansion of terrestrial homes. Better to start with "all the house a family might ever need", and grow into it slowly, than to start with initial needs and then add on repeatedly. Extra rooms can, of course, be blocked off so as not to be a dark empty presence. But they can also be rented out to individuals and others not yet ready for their own home, or waiting for one to be built.

Even more sensible is the suggestion that the extra space will come in handy for cottage industry in its early stages, before the new enterprise is established, matured, and doing enough business to be moved into quarters of its own. At the outset, with every available hand employed in export production, the demand for consumer goods, furnishings, occasional wear, arts and crafts, etc. will have to be met in after-hours spare time at-home "cottage industry." The lunar "Great Home" could meet all these needs elegantly.

### **Levittown, Long Island, New York: 1947–1999**

The recent 50th anniversary celebration for the bold experiment in cheap canned housing that was Levittown brought to our attention a book about the town: "**Expanding the**

**American Dream: Building and Rebuilding Levittown**” by Barbara M. Kelly, 1993, State University of New York Press, – ISBN 0-7914-1287-3 (/1288-1 pbk)/

As I was ten when this venture began, I have been aware of the evolution of Levittown all my life. Might we find in this story templates for a fast expansion lunar town? In three short years, over 17,000 Cape Cods and ranch homes, each in 5 versions, were built in Levittown, which today has a population of 55,000. In the post war (WWII) period, the market for housing was very strong and people bought what they could. The homes were inexpensive starters. Observers were almost unanimous in predicting that the development would become an instant slum. But they did not count on the resourcefulness and determination of the Levittowners.

Over the years they remodeled, rebuilt, customized, and personalized their homes. Today, while you can still see the Cape Cod origins, there is no shortage of diversity and variety. There was room for built-in expansion in the unfinished attics. Unfortunately, another built-in expansion opportunity was passed over in the desire to keep initial costs low: the homes had no basements. New York building codes must be more lenient than those in Wisconsin!

The lots were generous and the yards large. So eventually people added carports, then transformed these into garages, rebuilt these as family rooms and added new garages, etc. Family Rooms, dens, extra bedrooms, and other special activity rooms were the most popular additions.

The original cost spread of the homes was very small, in the \$7,000–\$9,000 range in 1947–9 dollars. Each house came with a kitchen, a living room, a bathroom, and two bedrooms – a start on the American Dream.

#### **On the Moon some needs will differ**

Owning a home gives people a stake. Nowhere will this be more important than on the Moon, where settlers will have made at least tentative decisions to forsake their Eden home planet, probably forever. I fault Robert Heinlein’s vision in “The Moon is a Harsh Mistress”: cramped underground rabbit warrens. On the Moon, lot costs are negligible with as much land as the U.S., Canada, Brazil, and China put together and currently somewhat less than very few people!

Yes, as long as habitat space is pre-manufactured on Earth and brought to the Moon at great expense, people will have to make do cheek by jowl. But once expansion space can be built from local materials, and constructed in assemblyline fashion, there is no need to be stingy. On the contrary, there are these reasons to make “starter” homes spacious:

1. On the Moon, there is no external biosphere, no shirtsleeve-friendly outdoors. People have to put their garden and lawn space indoors, e.g. in a central atrium. This works well with the on site pretreatment of toilet wastes [cf. MMM #116, pp. 9–11, “A Modular Approach to Biospherics” and <http://www.lunar-reclamation.org/page11mm.htm>]
2. On the Moon, with high vacuum outside, it will be much more difficult to “add-on” to established pressurized habitats and all the more reason to include generous unfinished spaces .
3. On the Moon, it will be especially important to give new stakeholders every chance to start cottage industries that eventually will become a strong private industry sector. Expansion space within the “Great Home” will serve as a land grant for such purposes. Those not enterprise-minded can use the space for other purposes.

As on Earth, starter homes will be rebuilt by their owners; there is no such-thing as a standard cookie-cutter family, either in size or in makeup. But people will customize their lunar homes as they have their homes on Earth not only to fit the changing size and evolving makeup of their families but also to express personal tastes in color, style, design, etc. Lunar homes are likely to have customizable façades on the pressurized streetways they front. The rest of the home will be buried in regolith (unless within a lavatube). Even so, some will choose to customize these mounds [MMM #55 MAY ‘92, p 7, “Moon Roofs”].

Lunar settlers need to get settled in large spacious quarters – pressurized, with thermal control, air exchange, electricity, and plumbing. But the interiors do not need to be pre-finished in any other way. All other internal work can be done in whatever degree of labor-intensity the new settlers are comfortable with. Settlers can be simply granted the deed to these homes in exchange for agreeing to settle, or earn them by finishing a set minimum of the interiors.

Levittown on the Moon? Yes, with these differences. We see no other way. <MMM>

MMM #127 – July 1999

# TransHab



## The Architecture & Promise of Hybrid Rigid-Inflatables

By Peter Kokh, early proponent of the concept

[“The Lunar Hostel: An Alternative Concept for First Beachhead and Secondary Outposts” by Peter Kokh,

Douglas Armstrong, Mark R. Kaehny and Joseph Suszynski, Proceedings of the Tenth Annual International Space Development Conference, May 23–27, 1991, San Antonio, Texas. Pages 75–92 (SDC 91–021)]

### Relevant Back Issue Readings in MMM

The Lunar Hostel paper, printed in its entirety in the Proceedings above, was serialized in MMM, issues #s 48–50; {MMM Classics #5} plus other relevant readings

MMM # 33 MAR ‘90 pp. 2–3 “Lawrence Livermore Lab Takes on NASA”

MMM # 48 SEP ‘91 pp. “Lunar HOSTELS Part I: Amphibious Vehicles”

MMM # 49 OCT ‘91 pp. 3–6 “Lunar HOSTELS Part II: The Hostel’s Share of the Workload”

MMM # 50 NOV ‘91 pp 6–7, “Lunar HOSTELS: Part III: Some Appropriate Architectures”

MMM # 51 DEC ‘91, p2 “Hybrid Rigid-Inflatable Structures in Space”; “Camp Millennium Design Competition Proposal”

HARVEST MOON #2 Spring ‘94 p 3 “The Moonbagel™: A hybrid rigid-inflatable Lunar Beachhead Design that promises generous ‘acreage’ for farming”

## **The Problem and the Challenge.**

Outpost crews on the Moon or Mars as well as travelers on long duration space voyages or personnel in space stations and other orbital facilities face months-long stays. If they are to do a good job, make effective use of their precious, expensive time, and maintain productively high morale, they will need one thing that, save for Skylab back in the mid-70s, has been absent so far: “elbow room” – and lots of it.

The Space Shuttle Payload Bay, as well as the payload farings of existing and proposed unmanned “heavy lifters” share two things in common: tight weight constraints, and a cylindrical volume. The space station habitats of the various ISS international partners all have been designed to live with these constraints, and show it. There seems to be no getting away from the now all too familiar sardine “can”.

More generous payload bay space has been on the drawing boards for a long, long time. Without resurrecting the Saturn V, the most promising options are various shuttle derivatives, especially cargo carrying add-ons to the 27.5 ft. wide shuttle External Tank. The ET “Aft Cargo Carrier” has existed on paper for well over a decade, as various proposed ET topper farings. Length for length, modules designed for the wider ET farings would be over three times as spacious. But even that 27.5 ft. wide diameter would seem to impose limits on elbow room from which it would be nice to be free.

The obvious answer is to design a station or base as a complex of smaller modules, as we have done with Mir, and are attempting to do with ISS. This provides an outpost we can grow into, growing the structure itself as we go along. It requires multiple flights and space-suited assembly in an unforgiving and difficult vacuum environment.

For Mars expeditions, there seems to be a hard choice between:

- A single direct, Earth-surface-to-Mars-surface shot with a space station-sized crew habitat
- A long wait for a post-shuttle vehicle with a wider payload bay and a heavier lifting capacity
- An expensive orbital assembly process – the very von-Braunesque/SEI trap that most let’s-open-the-Mars frontier advocates would like to avoid

On Mars especially, where mission opportunities come 25 plus months apart, it would seem crucial not only to provide elbow room on the surface from the gitgo, but to be able to have it en route, so that the crew does not arrive on the scene psychologically debilitated by “caged-rat syndrome”.

For post-beachhead Moon and Mars outposts, we can take the long view and look for larger settlements-in-the-making built on the spot from modules made of building materials produced from local regolith soils. The question is how do we get from the sardine-can present to the spacious future.

### **How about “Inflatables”?**

Back in the late eighties, Lowell Wood of Lawrence Livermore National Laboratory (California) proposed an alternative architecture to the current S.S. Freedom designs and design philosophy. For much less money, he argued, you could deploy a much more spacious space station made out of inflatable modules. Two things popped this balloon:

- Inflatables capable of maintaining pressure in space with all the micrometeorites and man-made debris floating around seemed an unproved concept at best, and dangerously foolhardy at worst – there had been no tests of an inflatable fabric or an inflatable fabric sandwich under conditions simulating such an environment
- Such inflatables would have to be fully outfitted in space and this would require even more man-hours out in space suits than the worst-case prognosis for Freedom type designs

So Wood’s ideas were generally dismissed, no let’s see-what-happens tests conducted, planned, or even considered by NASA. A few space advocates continued to play around with inflatable concepts. And, to its credit, NASA-JSC did try to integrate an inflatable into its Moonbase architecture, a spherical multi-story inflatable to be protected from the harsh elements by regolith-filled bags piled around and on top, igloo style. This provided elbow-

room but again, required extensive post-inflation outfitting, making for a complex and riskier deployment.

But, with Congress adamantly averse to even hearing the word “Moon” no real R&D was done on inflatable fabrics. “Inflatables” seemed to be DOA.

### **Enter Copernicus Construction Company**

Copernicus Construction Company is no more than the whimsical name we in the Lunar Reclamation Society picked to refer to our “Define & Design” fun-activity brainstorming group. In the fall and winter of 1988–89, against expected fierce heavyweight competition from groups like Seattle L5’s Boeing-laden SLuGS [Seattle Lunar Group Studies], we had decided to enter the National Space Society’s Space Habitat Design Competition: Category – Lunar Base for 1,000–5,000 people. Our three village settlement built within a rille and dubbed tongue-in-cheek “Prinzton” for its site near the crater Prinz (SE of Aristarchus) came in second. (The winning proposal did not satisfy all the design criteria, but was that of a single architectural student and therefore a more fitting recipient of the \$2,000 prize.) Eight people from the chapter worked on Prinzton.

As an encore, four of us worked on a paper for presentation at the International Space Development Conference in San Antonio in 1991, two years later. The hook of our paper was the concept of the “hostel”, a “big dumb volume” which could function as a complete lunar outpost when and for as long as an “amphibious” (space/surface) crew cabin, dubbed a “Frog.”

### **Our idea here was to earn multiple savings:**

- The lunar ferry would be designed with its crew cabin underslung beneath the main platform between the engines, with the fuel tanks on top. On landing, the crew cabin would winch down to the surface, it’s built in mobile chassis deployed, and then taxi over to the outpost site. [Note: this concept, outlined in the published San Antonio paper, has since popped up in NASA drawings]
- At the sight, already tele-deployed and shielded, would be some kind of “big dumb volume”, a pressure-holding container with a dock
- The amphibious frog would already possess all the systems needed to maintain human life: air and water recycling and conditioning, thermal controls, communications, first aid medical, computer work stations, etc. Why duplicate them expensively in a sometimes unmanned habitat structure, when the latter could enjoy them when the frog was docked with it?
- We carefully separated “functions” best assigned to the “Frog” and those best assigned to the “Hostel” This “define-what-it-is-we’re talking-about” work behind us, we began brainstorming ways to provide that “Big Dumb Volume”. Six architectural approaches were sketched out in the paper:
- An all-rigid telescoping can-within-a-can – [NOTE that a recent NASA sketch of a lunar lander has an “extra” room telescoping out of the cabin once the craft is on the lunar surface]
- A rigid-inflatable “sandwich” in which the ceiling and floor, both pre-outfitted with pop-out, pull-down, pull-out, pull-up features are joined by inflatable walls
- A rigid-inflatable “slinky” with two works-packed open-ended cans are joined by an inflatable cylinder ribbed with a helical systems-conduit providing plug-in anywhere communications and electrical chases
- A hinged-three-part floor which would open flat with an inflatable “quonset” structure above, the pressure ingeniously reinforcing the stay-flat floor by means of over-pressurized bags alternating right/left 2/3rds hinged sections
- A “Donut” inflatable torus that pops out of the walls of a “hexagonal works-packed” rigid cylindrical structure in the donut “hole”. It was this TransHab prefiguring hybrid rigid-inflatable architecture that seemed to us to be the most promising way to get the most out of the shape/ weight constraints of the Shuttle payload bay – or of an External Tank Aft Cargo Carrier etc.

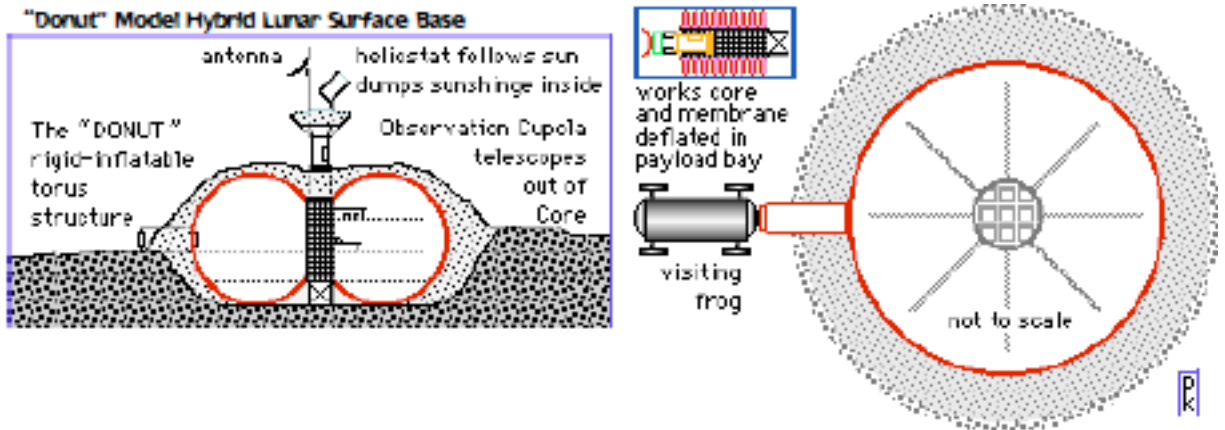

### “Donut” Model Hybrid Lunar Surface Base

The “donut” could be loaded with pull-out built-in features: top-mount central solar, visual, and EVA access, side-wall vehicle docking port, decking parts brought up in the core module’s “basement”, and a peripheral jogging track. The inner surface of the outer side wall could be pre-painted or printed with a 360° panoramic mural medley of Earthscapes and Moonscapes.

Two extra coupling ports in the outer wall at 120° angles we would make possible ‘benzene ring’ clusters of individual donut units for open-ended “organic molecular” expansion potential. Small conventional instrument-packed can modules brought up from Earth and coupled at unused ports would allow endless upgrades.

- A sixth architecture, dubbed the “trilobite” was fleshed out after the paper was sent to the San Antonio conference Proceedings, but was printed with the serializing of the paper in MMM. In this design, the cylindrical works core is designed to be deployed on its side, instead of vertically, with twin inflatable cylinders being deployed out of lockers on either side.
- Also post San Antonio, several rigid-inflatable applications for use in space stations and deep space vehicles were sketched out in MMM # 51

The “donut” has since been more aptly dubbed “the Moonbagel” by LRS at-large member David A. Dunlop. The concept of a vertical works-core tailor-made for a cylindrical payload bay and pre-integrated with an inflatable sidewall torus seemed elegant. Previous writers dealing with inflatables commonly described spheres and cylinders. But on a gravid surface either needed to be stabilized upright – they were per se prone to roll. The torus, however had four considerable and unique advantages:

1. A wide, extremely stable footprint
2. A generous weight distribution
3. The lowest possible overall profile or height, a very important consideration when considering how to apply regolith-derived shielding
4. Together with an integrated works-packed core module, it came pre-outfitted, ready to occupy

As we were interested in the concept first and foremost for lunar (or Martian) surface (or intra-lavatube) applications where there would be no post-deployment exposure either to ultraviolet or micro-meteorites, we did not address the need to “armor” the inflatable wall through layering. We realized, of course, that that would have to be addressed before analogous structures could be deployed in space station or deep space transit situations.

We also did not feel the need to land a pre-deployed structure (we imagined the structure being landed on legs attached to the base of the rigid core module [not to the inflated torus as in the PM illustration at the start of this article], then inflated, then occupied.) This, however, is just the more difficult application for which NASA-JSC has now developed the same

architecture. For a human Mars expedition, we need elbow room not only on the surface after the crew arrives, but in transit from Earth to Mars, simply because the journey will be several months long, not just a few days. So the JSC team brainstormed a structure that would be both a better “Transit Habitat” [thus TransHab] and a lighter weight Mars Hab module. Elegant!

Yet this “amphibious” requirement has had its design result both in constraining the radius of the inflatable envelope and in the banding of its outer wall to a flattened less modest than that possible for a structure deployed only after landing. Thus the volume multiplier (ratio of full inflated size to available payload bay space) is held to just under “three” times that offered by a conventional rigid module designed to fit the same payload space. Without the “transit” (e.g. through Mars’ atmosphere) there is no intrinsic reason that this multiplier couldn’t be as high as 150! (The formula is  $pR^2 - pr^2$  see illustration:)

Whether someone at JSC had read or heard of our San Antonio paper firsthand, secondhand (the appearance in NASA planning of two other seminal concepts from the same paper would lead one to expect this) or not at all, does not really matter. The “PROBLEM” which we started off to address must sooner or later be obvious to anyone who looks at the situation long and hard, and the solution we came up with is in the end equally “obvious,” at least in retrospect. Throughout history, obvious engineering solutions have been independently “invented” by two or more persons or teams on many occasions.

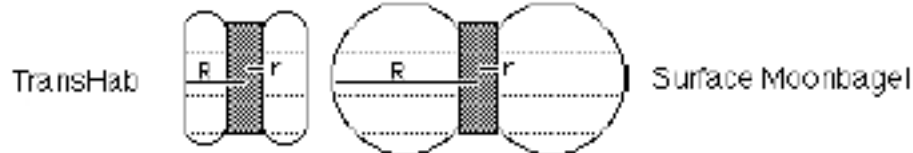

When I toured the NASA TransHab facility at Johnson Space Center on May 29th this year (1999) while at NSS’s ISDC in Houston (thanks to Jerry Smith for the free ticket – Sorry, you couldn’t make it Shirley!), I was filled with a deep excitement to see that our concept was being vindicated by the TransHab engineering team and that many of the design challenges we anticipated had been successfully worked out with practical engineering solutions. After all, we had neither the expertise, nor the resources to further elaborate our seminal concept further.

Indeed, we had wanted somehow to find the money to conduct a national design competition to flush out engineering options to these various design challenges that our paper left untackled. The “Camp Millennium” contest would have had several entry divisions based on sets of problems to be tackled and the various applications (general habitat, laboratory, construction camp, farming pod, hotel/motel, etc.) .

Finding this money was one of several drivers behind LRS\*’ bid to host the 1998 ISDC in Milwaukee. By the time we had realized the needed up front funds to organize and promote the competition as well as the principal prizes, the TransHab team had already nearly completed much of the task. That there is more work to be done we discuss below.

- The (Milwaukee) Lunar Reclamation Society, a chapter of the National Space Society( **Competition, yes! For just an “inflatable,” no!**

One of the considerations that has divided the space community over TransHab is the feeling that “any new habitat space to be added to the Space Station should be commercially supplied.” We have no quarrel with that assertion. Indeed we in LRS wholeheartedly support that as a requirement.

At the same time, it needs saying **loudly** that it is likely that most such objectors have paid no attention to the architecture of TransHab itself. It is **not** just an inflatable. Its virtues spring from it being a Hybrid Rigid–Inflatable designed to make the most of the shuttle’s payload bay capacity, as well as to be fully outfitted. These are two virtues that neither Lowell Wood’s nor Willey Sadeh’s inflatable architectures appear to have exhibited.

On the other hand, NASA could require both these needs to be addressed in any submitted bids. It would not be surprising if in such a situation, our “donut” architecture would

be the principal feature of several, if not most serious bids. One thing is sure – other engineering solutions would be flushed out. Quite possibly some would be better and/or cheaper than those found by the Transhab team. That is the whole virtue of honest competition!

### **Life-or-death considerations?**

Whether the TransHab team is allowed to continue (and finish) its work or not, should not be a matter of life-or death to any space enthusiast, whether the foreseen application is as a space station expansion module, a transit habitat to Mars doubling as a Mars surface station, a spacious cycling cruise

ship habitat area, a habitat deployed within a lunar lavatube or covered with regolith out on the surface. The basic architecture is sufficiently self-evident and elegant as a solution to a general problem that is likely to exist for some time to come.

If the TransHab team had not “invented” this particular hybrid rigid-inflatable architecture (or at least made it their own by all their work), it would inevitably have appeared sooner or later nonetheless. It is too logical an idea for any shortsightedness or objection to the way it is pursued to “nip it in the bud”. It can’t be “outlawed”. It will spring up again.

In the light of the Administration’s (and Congress’s) strong desire that NASA not address a Humans to Mars expedition until the endlessly beleaguered International Space Station is finally a completed reality, the TransHab team had to find another funding home and rationale to continue its research and development. Whether it was Donna Fender’s idea, Dan Goldin’s or someone else’s does not matter. Proposing it as a possible addition to ISS or even as a replacement for the conventional Boeing habitat module already under construction proved to be ill-fated. Leaving the name “TransHab” with its telltale connection with the Humans to Mars program did not help. But perhaps it was all they could do to buy themselves more time and finish the R&D, an indisputable NASA mandate function.

In our opinion, it is a good turn of events that the TransHab effort got as far as it did, and that a great many of the critical key concepts have been validated and engineering solutions found. This R&D provides the essential platform for the entrepreneur to step in. In this sense, if the pro-space objectors to the TransHab project would have rather the project not been begun by NASA, or at least have not been allowed to get this far, they would only have shot our shared commercial space dreams in the foot.



A NASA-JSC illustration of an ISS version of TransHab attached to the space station. The evident teardrop shape seems to this writer to have been a case of artistic license that makes no sense at all and implies that a hard shell had been added.



The idea of testing out the Mars Habitat as conceived by Robert Zubrin by attaching a prototype to the Space Station as a commercially supplied hotel module was proposed several years ago by fellow Wisconsin space activist extraordinaire George French (the man behind the Moonlink™ educational program linked to the Lunar Prospector Mission.) <MMM>

Below: the short, 1-story TransHab prototype at JSC

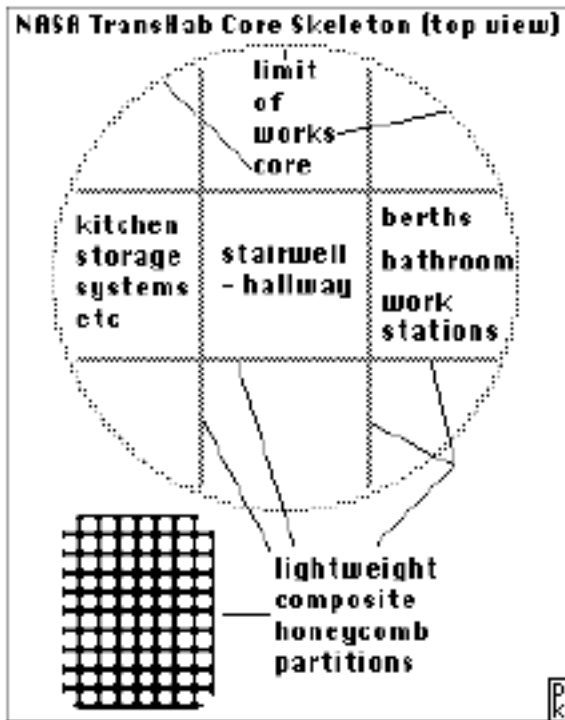

MMM #131 - December 1999

## Improving The Moon

### Part II: The "Developer's" Role:

**The Moon "as is" is not an attractive piece of Real Estate. Putting together a package to attract anchor tenants and a "viable mix" of other clients, splitting costs & burdens, may be just the "accelerant" needed to start Lunar Development in earnest.**

by Peter Kokh, © 2000 The Lunar Reclamation Society

[*"The Developer's Role"* was first published in Moon Miners' Manifesto # 131, December 1999]

### Improved Real Estate

Most readers will be aware of the distinction between "improved" and "unimproved" real estate. "Improved" real estate has on site or boundary access to utilities like water, gas, and electric. The lot may or may not have other "improvements" e.g. drainage grading. "Unimproved" real estate is just raw ground, with no utility access, perhaps not even road access, the kind of stuff Florida and Nevada fly-by-night "developers" want to sell you in the middle of a swamp or desert for a "bargain of a lifetime" price/ Lot's of luck doing anything with it!

### All lunar real estate is "unimproved"

That does not mean that some locations are not better advantaged than others. Polar sites may have access to water-ice reserves. Highland/Mare Coastal sites have access to both major suites of pre-pulverized (read "pre-mined") regolith. Sites along the Mare Imbrium rim

are richer in Potassium and Thorium and KREEP elements. And so on. But these are natural assets. No land on the Moon is man-improved, i.e. with utility access, or with any other kind of location-location-location traffic generating engineered "improvements." This is a daunting, if not intimidating fact facing anyone who has a free enterprise idea for a lunar location.

### **The same can be said of Mars, of course.**

Allen Wasser has proposed a lunar "land grant" program to attract lunar development. But perhaps the only ideal customer for such a real estate regime is the "developer" who will go into the prospect site and make improvements that will render it especially attractive to specialized mining, processing, manufacturing, and other types of private enterprise. The first such developer to "improve" a resource-rich well-situated site, may, in the process be founding the first genuine lunar settlement. Even if there is already a scientific outpost on location, without improvements the "settlement" will not come.

### **The perspective of other interested parties**

The mining company, the manufacturing company, the hotel operator, do not want to have to do such unaccustomed preliminary work as setting up power supplies, providing water, building a space port, providing communication relays, etc. If these things were already in place, ready to "plug into" and ready for "hook up", the location would be immensely more attractive. Industrial and commercial enterprise would not have to assume the extra burden of paying for these improvement costs up front, but would merely tap in, and pay a monthly or annual usage charge: utility bills. This drastically cuts their financing costs as well as the time between arrival on the Moon and first returns on investment. It makes their job in closing a deal at a bank that much easier, more realistic.

### **The Lunar Site Developer's tasks:**

#### **(1) Picking a Site for Improvement:**

The first task is to analyze candidate sites on the basis of "strengths & weaknesses". The developer should draw up an "Existing Conditions Map." This will include the topography within the area, noting potential obstacles and assets for construction. If there is a science outpost already established, any sharable assets (power, communications, roadways, launch pad) should be noted.

Do assets outweigh liabilities? Are there any "targets of opportunity" such as proximity to uncommon but valuable resources, passages through topographical obstacles such as passes through nearby ridges, natural bridges over nearby rilles? Are there known intact lavatubes in the vicinity? What is the ratio of highland-derived to mare-derived soil in the local regolith? Are there scenic highlights in the area? Is there enough flat terrain for emplacement of large solar arrays? Is there a logical location for a spaceport?

What are the liabilities? Lack of easy access to neighboring areas of the Moon? Uneven terrain? A large number of inconveniently placed boulders? Rilles or ridges that are not easily negotiated? Such liabilities must be weighed along with assets.

Next the developer needs to brainstorm this mix of assets and come up with a winning strategy to attract enterprises to buy in the development.

#### **(2) The Site Development Plan**

Site development plans should work with the lay of the land, develop topography suggested transportation corridors in the vicinity. The location must be picked for the spaceport with adjacent surface warehousing and shipping/receiving areas. Will the spaceport provide loading and unloading equipment so that incoming freighters do not have to carry the extra mass of self-unloading equipment? Developing the Port Facility will be part of Phase One. A graded Road Network linking identified industrial park properties and residential and commercial areas and other special identified use areas must be provided. Easily gradable roadways to important nearby off-location resource-rich areas should be identified and marked. Care must be taken that all such identified sites are easily serviceable both by road and by utility providers.

### 3) Financial Considerations:

The proposed development must be

- Market supportable
- Physically doable
- Financially viable

To this end, the developer needs to take on "natural partners" in order to subdivide the task and conquer the load. "Natural Partners" will include:

- A power generation company (solar &/or nuclear)
- An oxygen production facility. Among potentially competing proposals, one that employs processes that produce enriched tailings especially attractive to other potential manufacturers should be given the nod. Such beneficiated byproducts will help identify and attract other clients.
- A water production facility. If the site is not proximate to polar ice fields, and the developer does not wish to co-develop such icefields along with a means of transporting water, or hydrogen produced from it, to the development site, then, if hydrogen produced by heat-scavenging of any and all regolith moved in development of the site does not produce enough to be reacted with locally produced oxygen to meet needs, the balance must be brought from Earth. The only rational way to meet primary water recovery and waste treatment needs is on the spot where the water is grayed. This will be a burden each tenant-client of the development must assume. The development's shared mini-biosphere must be modular both in construction and in maintenance. This means primary treatment at the source of the problem for both water and air.
- A mining processing-building component manufacturer to turn out prefab modular building components to fit customer needs, in order to defray the cost of bringing additional pressurized volume from Earth at much greater expense.

Such a partner building component manufacturer could then enter into a joint venture with the developer to produce "turnkey" factories, ware-houses, commercial and residential properties for other clients on the basis of need and request.

Additionally, such a company could construct "hanger sheds" or space-frames constructed of glass composites or steel, covered with plates of the same material, then over-blanketed with regolith to provide "improved" radiation proof "lee vacuum" for easy set up of modular habitat structures, especially less expensive, lighter, cheaper to ship inflatables and hybrid rigid-core inflatables (on the TransHab model). Such hangers or ramadas might be built as rille-spanning vaults: virtual man-made or more exactly, man-restored lavatubes, which is what most sinuous rilles originally were.

Another joint venture would be to provide improved access (graded ramps and elevators) to any buildable lavatubes in the area. Shafts drilled through the lavatube ceiling/roof filled with fiber optic cables, with sun collector on top and light defuser within the lavatube, would be an immensely attractive improvement, as would be a lavatube floor topographic map. No enterprise will buy space within a lavatube, no matter how many theoretical advantages it offers, without solid concrete information, and prepared access and minimal lighting.

These "Natural Partners" will be the "anchor" tenants" necessary to attract other partners, clients, and tenants to the development. These latter must be identified with special care to create a viable mix of enterprises that will both provide a healthy balance of diversified exports and meet a major portion of the physical needs of the growing community of people locating in the development to run and operate the various enterprises:

- Modular housing, other pressurized structures
- Furniture and furnishings
- Food
- Other basic products

## Summary

This is a plan in which costs are identified and shared in a manner that makes the development

- Physically doable
- Financially viable
- Environmentally compatible
- Politically feasible

It is a prescription for a rational plan to share both equity and debt, to remediate any waste problems, and to share the costs of further improvements useful for all or most parties. PK

MMM #132 – February 2000

## Collapsed Lavatube Make-Overs Recreating Shelter Space inside Rille Valleys

By Peter Kokh

We've talked a lot about the use of lavatubes with their ready made shelter from both the harsh cosmic elements and the harsh surface conditions of extreme temperature swings and insidious moondust. But what about "ex-lavatubes", the collapsed lavatubes whose ceilings were evidently too thin or too weak to stand the test of time? Are these no more than fascinating, scenic, geological ruins? After all, some areas may have rilles but no handy intact Lavatube sections? And even if a site offers both, as is likely, can anything useful be done with rilles?

We got our first and only up close look at a sinuous rille valley when the Apollo 15 crew visited Hadley Rille at the foot of the northern Apennine Mts. which form the SE ramparts of Mare Imbrium and separate that great "sea" from Mare Serenitatis. Hadley is about 150 km SE of the rim of the prominent 75 km wide crater Archimedes. The rille itself is about 135 km [c. 85 mi] long and 1-2 km wide from rim to rim [1,000-2,000 meters or yards]. The small section actually visited was 370 m [c. 1200 ft] deep. We can assume this as typical, with rilles that are both narrower and shallower, and wider and deeper. These dimensions give us a fairly accurate way of reconstructing the size of the original tube. The whole report referred to at right is online: [http://www.lunar-reclamation.org/papers/rille\\_paper1.htm](http://www.lunar-reclamation.org/papers/rille_paper1.htm)

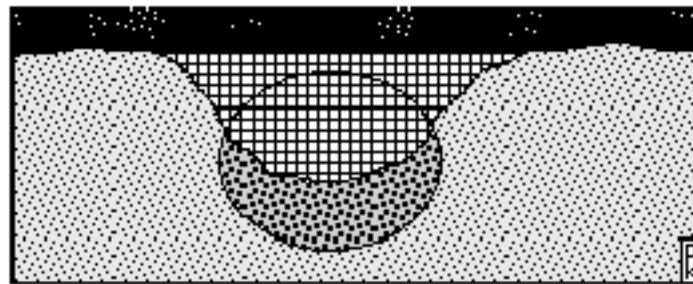

In the illustration above, the current cross-section profile of the surviving rille is cross-checked. The oval represents the size and location of the original tube. The crosschecked area above the lavatube ceiling has collapsed onto the lavatube floor and is represented by the heavily checked area below the current rille floor.

If the mission plan for the chosen site calls for the establishment of a sizable surface shelter, any rille valleys within the site boundaries should be seen as substantial pre-excavated areas that need only be spanned with regolith covered arched roof spans to provide the same protection from the cosmic elements as did the once intact lavatube. A plate covered space frame arch, extending from one wall to the other, partly down both slopes, could then easily be

blanketed with regolith by dragging material down on top of the arch from the rille shoulders above. The arch could be of any length, with an original section extended in either or both directions at a later date.



In the illustration above, a strong, lightweight arch of space frame construction (lunar glass composites) spans the rille valley from one wall to the other, and has been covered with 4–6 meters of loose regolith using drag lines to pull loose material down from the rille shoulders above. The lightly shaded area below, represents the space, still vacuum, that is now in the lee of the cosmic elements: cosmic rays, solar flares, and the micrometeorite rain that still washes the exposed space above the blanketed arch. The floor of the protected space lays above the rubble of the collapsed ceiling of the old lavatube.

### Previous Treatment of the Concept

During the winter of 1988–89, in response to **NSS' 1989 Space Habitat Design Competition**, an eight person team used the idea of spanning a rille valley as the keystone of the Lunar Reclamation Society's second place entry in the category: **advanced lunar base for 1,000–5,000 people**. We were looking far into the future, as the competition guidelines asked, and designed a pressurized two-tiered arched shelter. We published a serialized report under the title "Ventures of the Rille People" in MMM "s 26, 27, 28, 29, 31, and 32. [Reedited

Here we are taking a more modest, near term look at the possible utility of rille valleys and are proposing a simple shielding arch, open at both ends, providing shielding but not pressurization. What we get from this is a spacious calm, lee space anchorage, ideal volume for the erection of a modular base or outpost complex of either hard shell or inflatable shell modules or both, that will not need further protection. Such a protected site, within which construction workers and others need only wear simple unhardened pressure suits, is very attractive.

This idea is similar to the concept of a hanger shed outpost such as we described in MMM # 89 OCT '95, p. 3 "Shelter on the Moon" [ <http://www.asi.org/adb/06/09/03/02/089/shelter.html> ] In comparison, rille valley structures would be both larger and easier to cover with shielding moondust.

### Improving the Lee Space Underneath

While the space underneath such shielding arch hanger would be environmentally benign in comparison to the exposed lunar surface, without further modification, it would be pitch black even during lunar dayspan. There are a number of ways to channel diffused ambient sunlight to the sheltered space below, making it much more attractive. Banks of sun-following mirrors on top of the vault shield could channel concentrated sunlight via fiber optic shafts into the space below.

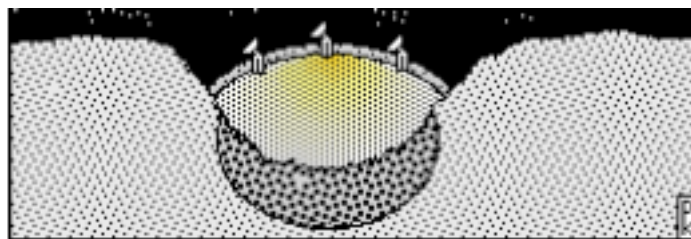

Similar banks on the rille valley floor, fore and aft of the hanger area, could bounce channeled sunlight off the underside of the vault for diffuse ambient lighting. During nightspan, large electric lamps could use the same light delivery systems.

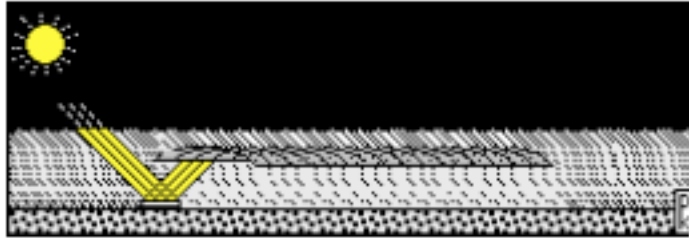

The result would be a benign, construction-friendly, softly lit environment with moderate temperatures. The cost of constructing a vault shield can be balanced against the costs of excavation and unit by unit shielding of alternative surface methods.

That undertaking such an effort implies the establishment of a prior glass composites building materials industry can only be seen as a welcome foundation for an eventually much more diverse lunar industrialization. The time take such a committing plunge is at the outset. Delay in crossing the industrial threshold only extends the period of vulnerability to program cancellation.

### **Future Upgrades**

The initial vault shield can be extended up and down the rille as the outpost-settlement complex grows underneath. "IF" care is taken to secure cables crisscrossed over the top of the structure to bedrock deep into the rille walls, the ends could be closed and the volume within pressurized.

Sinuuous rilles are to be found in mare areas around the Moon, in the same haunts as suspected lavatubes, their surviving sibling features. Why did some tubes collapse? Thin, relatively weak ceilings could easily have been compromised by modest meteorite bombardment. But the rilles' very large size leads this writer to suspect that they may be the ruins of unusually large lavatubes forming from unusually wide and rapid flows of lava, leading to ceilings too thin in proportion to the width spanned. If so, it suggests that most surviving intact tubes will be somewhat smaller in cross-section. For whatever the reason or reasons, these features are there. We might take advantage of some of them, preserving the rest for scenic and geological enjoyment. <MMM>

## *Liquid Airlocks*

### **For Cargo in & out of Lavatube Habitats**

By Peter Kokh

In MMM # 17, July 1988, we introduced the concept of liquid airlocks, not for people but for small import and export items. The aim is to cut air losses through repeated cycling of conventional airlocks.

- Every effort should be made to preserve the high external vacuum of the Moon – priceless both for science and industry
- Even though oxygen can easily be replaced, nitrogen is rare on the Moon The idea is not hard to explain to anyone who is familiar with a barometer, a common device used to measure fluctuations in air pressure as a clue to coming weather changes. A barometer is a bent glass tube, closed at one end, open to the atmosphere at the other end filled with a set amount of a liquid, commonly mercury. Sea level air pressure supports a column of

mercury 76 cm or 29.92 inches high. If you were to make such a device large enough in cross-section, you could run a conveyor belt through it to carry properly sized items out of the pressurized habitat into the surface vacuum, or vice versa. For some situations, this might be ideal.

**Liquid mercury is very dense, 13.5 times as heavy as water.**

This keeps the size of the device compact. For a liquid airlock on the Moon, we would need to import considerable amounts of this liquid metal at great expense. If we use water instead, relatively much easier to source locally, the column needed to keep vacuum out of a sea-level pressurized habitat in one sixth gravity would be significantly higher: over 61 meters or 200 ft. But it is more likely, to minimize both the amount of nitrogen needed and stress on the hull(s), that we would use half that pressure level. That's still 30 meters, 100 ft of water. This height is impractical for conventional subsurface facilities. It seems just right, however, for use with lavatube facilities and rille vault shielded outposts.

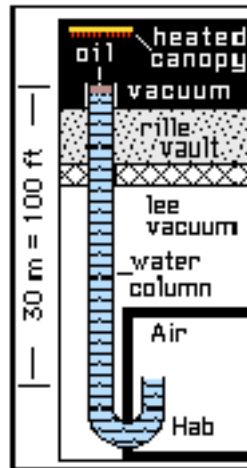

The weight of column of water 30 meters or 100 feet high exerts enough counter-pressure to keep habitat atmosphere at 0.5 Earth normal (42% O<sub>2</sub> , 58% N<sub>2</sub> ) pressure from flowing out the open ended J-shaped tube. A layer of oil, lighter than the water, keeps the water from boiling away into the vacuum while a heated hood keeps the surface warm enough so that neither oil nor water will freeze.

Water has a relatively low boiling point and a high vapor pressure, but both seem tractable. At the surface, a heated hood would greatly reduce the propensity of water to loose temperature to the cold of space, as well as shading the exposed liquids from the heat of the dayspan sun. A layer of oil would minimize sublimation into the vacuum. Goods in transit must be able to tolerate and shed this oil.

Of course, the conveyor belt must not snag, not ever! So the real "invention" here is not the barometric airlock itself to keep habitat air pressure safely inside, but the features that make it work as an avenue for bringing goods from the vacuum above into the atmosphere below and vice versa: the snag-free conveyor system that works well in four media: vacuum, oil, water, and air, and which has to be able to convey a variety of items in some useful range of sizes if it is going to be useful. This "invention" waits to be developed.

#### **Other Liquids? - Gallium & NaK**

Could other liquids be used? Gallium, 6 times as dense as water, would allow a much shorter column of liquid to do the trick and make liquid airlocks practical to use in conventional surface habitats that are shielded with just 2-4 meters of regolith. It is and liquid from 30 to 1983 °C (86 to 3600 °F) and that is very attractive. But on the Moon Gallium is a trace element not economically feasible to produce, so the amount needed (plus loss-make-up-surplus) would have to be imported.



NaK (pronounced knack) is a eutectic alloy of sodium (Na) and potassium (K) at 23% and 77% respectively. It is liquid just a little bit above room temperature up to about 800° C, a very serviceable range, and it has a high thermal capacity. Both sodium and potassium are sufficiently abundant on the Moon. in parts per thousand, to make local production eventually feasible. Discounting polar ice reserves, NaK is potentially the most abundant liquid producible from lunar regolith. But it has a density comparable to that of water so there is no advantage if shortening that 30 meter column is the goal. More importantly, it is nasty corrosive stuff.

### **Conclusions & Spin-up Opportunities**

Twelve years ago, when we first broached this novel idea, it seemed impractical. The density of the working liquid right to fit the needs of surface-shielded habitats was offered only by Gallium. Polar ice seemed unlikely, and NaK did not behave well.

But for the elevation difference between the lunar surface and a lavatube or rille-bottom outpost, polar ice water now seems ideal. Are their spin-up applications on Earth that could drive profitable predevelopment of this technology? Perhaps as a clean conveyor system between the outside atmosphere and closed rooms with special, even toxic atmospheres for special industrial use? <MMM>

## **“Skylight Domes” for Lavatube Towns & Vaulted Rilleplexes**

Like so many “mushrooms” sprouting from underground fungal mats, floral gardens, arboreta, picnic park areas, and restaurants could grace domes capping elevator shafts from below.

By Peter Kokh, with thanks to Uffe Jon Plug at [uffe@ploug.dk](mailto:uffe@ploug.dk) for his suggestion

We have talked several times about solar and visual access for Lunan pioneers who must live under a blanket of moondust to enjoy the same protection from the cosmic elements that we Terrans take for granted from our blanket of air. Periscopic windows, fiber optic shafts for sunlight are one thing for habitats immediately (2–4 meters) below the surface.

But what about providing solar and visual access for those living much deeper below within lavatubes or under rille-spanning regolith covered vaults? There will be elevator access for both goods and people as a matter of course. So why not add a few more elevators, at intervals, that open up on the surface within pressurized domes, more generously flooded with sunlight and affording expansive views of the surface. Cosmic ray shielding afforded by such domes would be minimal, so no one could live there, or even habitually frequent such delightful places.

What about operating personnel – gardeners, restaurant waiters, and others? What might work is for each exposed surface facility to be “sistered” with several other places offering similar employment down in the lavatube or under the rille shield. For example a surface restaurant could be part of a chain, the others all being in fully shielded surroundings.

Waiters and other personnel would then take turns – for example working one day a week up above, and even that on a volunteer basis. That way, accumulated exposure could be managed. But even then, one would want to limit the years spent in such a pattern.

Even if one visited such surface facilities on the same frequency that city dwellers on Earth may go to the local arboretum or a botanical gardens or to a tower top special occasion restaurant, just having such places to go to would relieve the psychological pressures of living below surface.



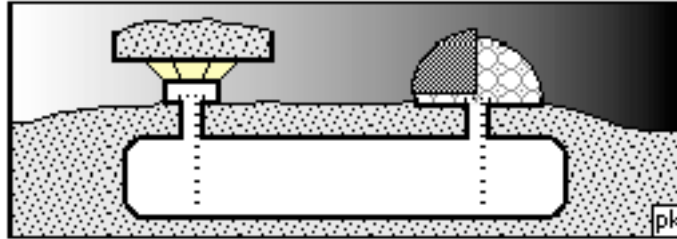

As glass is much stronger under compression than tension, geodesic domes will have convex panes, curved inwards, to help manage the considerable forces of pressurization. If the facility serves mainly as an observation area, it could be built more like an airport control tower than a dome. a row of windows with panes sloping outwards at the top could be covered with a generously shielded roof with wide eaves. This would reduce exposure to cosmic radiation to the few degrees hugging the horizon. A movable shield could protect windows facing the sun when it was near the horizon, as on the day of dawn or the day of sunset or very near to the poles.

On the right, a glass dome, with a rotating half shield facing the Sun. On the left, a top-shielded observation tower, reminiscent of an airport control tower. Exposure to radiation coming from all directions of the sky is minimized by the shielded top cap. The base of the tower could have a pedestrian EVA airlock. Non-public areas in which personnel spent any appreciable percentage of their time might be fully shielded: the kitchen or the access area to the dumbwaiter if food is prepared and dishes washed below; bathrooms, utility rooms.

The ultimate would be a dome within a dome, with the space between filled with 2 meters of water. The “hydrodome” would provide soft filtered glare-reduced ambient light and considerable radiation protection. The “devil lies in the details” of all the plumbing and water circulation tricks needed to keep the water between freezing and boiling at all times.

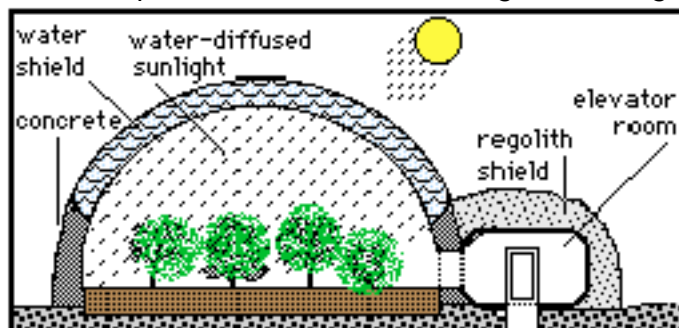

Such “escape valve” facilities must complement, not replace, more conventional ways to channel abundant dayspan sunlight, via mirrored shafts or fiber optic cable bundles, into the general habitat areas, to provide warm ambient light, accent-focus light, or both. Access to sunlight should be provided not just on special occasions, but as a matter of course. Yet lush surface dome gardens, picnic spots, and moonscape observation perches can provide more special treats. Lunans, and Martians as well, will have given up very much to earn a chance to pioneer new worlds. Every effort must be made to keep them as comfortable as possible and their lives as full as possible, and to minimize the sense of loss of Earth’s incomparable outdoors. <MMM>

MMM #134 – April 2000

## Lava Tubes: the “Developer’s Role”

By Peter Kokh

In MMM #131, DEC, 1999, pp. 10–12, we considered the “Developer’s Role” in “improving” a potential Moonbase settlement site to make it more attractive and marketable to would-be entrepreneurs. In this issue, we want to take up the topic again with specific application to lava tube sites, something the first article touched on briefly.

“Another joint venture would be to provide improved access (graded ramps and elevators) to any buildable lavatubes in the area. Shafts drilled through the lavatube ceiling/roof filled with fiber optic cables, with sun collector on top and light defuser within the lavatube, would be an immensely attractive improvement, as would be a lavatube floor topographic map. No enterprise will buy space within a lavatube, no matter how many theoretical advantages it offers, without solid concrete information, and prepared access and minimal lighting.”

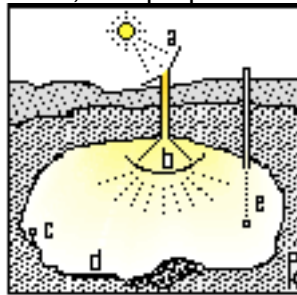

Here we want to expand upon these points. In MMM #100 NOV '96, page 6, we wrote about remote mapping methods, with radar “flashbulb” impacting probes to detect subsurface voids and side-looking orbiting infrared detectors to spot exposed lavatube entrances. In the next article, pp. 6–7, we wrote about on site robotic exploration and surveying techniques.

A surface crawling drilling rig, using high resolution orbital radar lavatube location data, finds its initial drill point over an indicated tube site. Given the repetitive nature of the tasks involved, a highly automated remote monitored operation will be ideal. It would:

- **Drill and stabilize** (a sleeve? side-wall fusing lasers?) a hole through the surface, penetrating the lavatube ceiling some tens of meters down. The hole might be only a few inches in diameter.
- **Winch down** through the shaft a radar-mapping instrument and/or CCD optical camera down to a height midway between lavatube ceiling and floor (determining that position is task one). A flare is released. The radar mapper and camera pan 360°, and from near vertical up (zenith) to near vertical down (nadir). The instrument pod is retrieved. A latitude/longitude/altitude benchmark is then lowered to the tube floor directly below.
- **Winch down** to the same point a length of fiber optic cable, securing the top end to the collar of the shaft hole below a solar concentrator passively gathering available dayspan sunshine, channeling it into the optic fiber cable. At the bottom end a diffuser scatters this light, so future explorers can find their way with night-vision goggles.

The drilling rig would then move on to the next position along the lavatube, guided by the data from the previous drill as to direction and distance to provide a continuous overlapping mapping. Now both the internal topography maps produced and the minimal light shafts produced in this effort can be considered an improvement. This would enable future manned science expeditions but only tease would be users. What can be done to really “improve” the site?

- **Enlarge and multiply the number of light shafts** to provide significant “naked eye” lighting
- **Feasibility and cost analysis of various ways to provide a high albedo “sky”** within the lavatube for maximum eye relief and ambient lighting, e.g. with direct coatings or suspended grids.
- Providing a **graded vehicle-worthy ramp down an entrance talus slope**, if there is one.

- **Provide a surface supported elevator shaft** through the tube ceiling/roof, the cage lowerable to the floor by cable winches (no guide structure within the tube). The cage should be of freight capacity able to lower vehicles and modules.
- **Topographical maps** of the floor with suggested grading using minimal (5–10%), moderate (15–30%) and major (above 40%) shifting of existing floor debris, and making use of “benches” and other features that may or may not be present. This would include recommended floor “road” corridors in each case. It would also locate recommended locations in each case for placement of modules and structures of various sizes.
- **An engineering test of the ceiling** at intervals to find its capacity to support suspended weight
- **A minimal line of sight communications relay system**, built into the “benchmarks” mentioned above using antenna when the benchmark is in a low spot, or into the light diffuser system.

Some of these “improvements” would entail nontrivial investment in the site, especially the freight elevator. A developer might be able to market the site on the basis of the less expensive of the suggested improvements in the site, along with a contractual commitment to provide the rest upon receipt of good faith money/down payment by the proposed customer. These further improvements might include minimal floor grading to provide a continuous travel corridor through–out the length of the tube, further grading up to the user.

Lavatubes offer immense volumes safe from surface temperature extremes, sheltered from radiation and other hazards of cosmic weather, and relatively dust free. That said, they are raw assets that require basic “improvements” to be useful. MMM

## MMM #135 – May 2000

### Cast Basalt: Startup Industry With Two Great Tricks

There is a growing, newly reinvented cast basalt industry in Germany, Spain, Britain, and the United States that is producing two types of products that will be very useful in the early lunar settlements: abrasion-resistant pipes & material handling (think regolith-handling) equipment [LEFT]

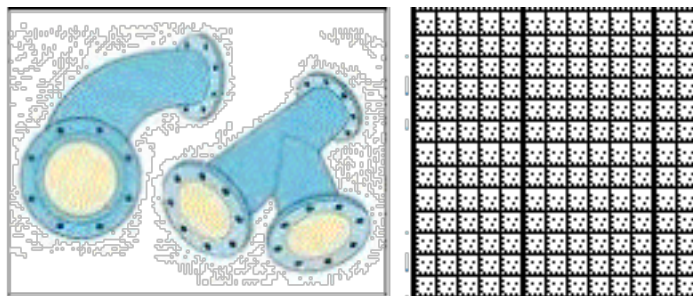

as well as countertops, and decorative wear-resistant floor and wall tiles [RIGHT]. These talents make a cast basalt industry a top priority. For more, see below.



### CAST BASALT: An Industry Perfect for a Startup Lunar Outpost

By Peter Kokh

Perhaps a decade ago, I read a one-liner in an encyclopedia about a “cast-basalt industry in central Europe.” Immediately the need of early Lunan settlements to hit the ground running with appropriate-technology industries came to mind.

Basalt! There is plenty of it on the Moon. The great flat lava flow sheets that fill the maria basins are essentially basalt. The regolith surface of these “Seas” is but meteorite impact-pulverized basalt.

There is plenty of basalt on Mars as well. The whole Tharsis Uplift area (Arsia Mons, Ascraeus Mons, and Pavonis Mons) is basaltic, as is Olympus Mons. And there are other lava sheet and shield volcano areas on Mars rich in basalt.

The idea of just melting the stuff with a solar concentrator furnace and then pouring it into molds to make useful products seemed a no-brainer. Even if cast basalt had (an assumption) low performance characteristics, there would be plenty of things needing to be made in the Moon settlements for which high performance would not be an issue. Table tops, planters, paving slabs came to mind.

But for years, I could find nothing more than that teasing one liner. Five years ago, I asked friends in the basalt-rich Pacific Northwest if they knew of any such industry in their area. This did not turn up any new leads. That was then. Today we have the Internet, and I finally returned to the issue and did a simple web search. Voilà! There is a thriving cast basalt industry here on Earth, and like most “materials” industries these days, it is vigorously reinventing itself. “And the envelope, please!”

#### **Cast Basalt’s Abrasion Resistance**

Casting basalt in itself is not something new. People began to experiment with it in the 18th century. Industrial manufacturing with this material began in the 1920s when Cast Basalt began to be used as an Abrasion-resistant, Chemical-resistant lining. The material is crushed, and heated until it becomes molten at 1250°C [2280°F], then cast in molds (e.g. tiles), or centrifuged into pipe shapes. The cast items are then heat treated so that the material crystallizes to take on extreme hardness (720 on the Vickers scale where mild steel is 110; 8-9 on the Mohs scale where diamond is 10). The density is 2.9 g/cm<sup>3</sup>. Two companies in Europe produce abrasion-resistant items for use in material handling (think of handling abrasive regolith moon dust on the Moon!): pipes, pipe fittings, cyclones, conveyor parts -- the list of applications is quite long. Both companies ship worldwide.

- **Kalenborn Kalprotect**, Vettelschoss, Germany <http://www.bulk-online.com/YD/Data/Co/09254.htm>

This company’s trade name for its cast basalt product is ABRESIST “one of the most tried-and-true materials for wear protection. It is high sliding, has a low coefficient of friction, good impact resistance, and very good chemical-resistance. More than 1 million of meters of pipe have been lined by Kalenborn with fused cast basalt.” Kalenborn also makes specially resistant products out of other materials such as fused cast carborundum (a form of Alumina, Al<sub>2</sub>O<sub>3</sub>) and high alumina ceramics, both of which can also be derived from the lunar regolith.

- **Antidesgast, S.A.** Barcelona, Spain <http://www.antidesgast.com/english/castbasalt.htm>

This company makes a similar line of products under the trade name of Basramite, “the world standard for ash slurry pipework at fossil fuel power stations. An all round cost effective, adaptable lining material, extending the life of equipment subject to erosion.”

#### **Abrasion-Resistant Materials on the Moon**

One of the strongest misgivings frequently expressed about the feasibility of industrial operations on the Moon is the very abrasive and “hard to handle” nature of regolith or moon dust. Cast basalt as a material up to the job of handling moving regolith in industrial and construction operations seems a “lunar” solution made in heaven.

Are there any qualifications? The chemical analysis of the basalt used by Kalenborn includes the expected aluminum, silicon, iron, and titanium oxides, but a higher than

typical percentage (on the Moon) of manganese, sodium, & potassium oxides. These elements are found on the Moon, however, in parts per thousand, not in parts per hundred.

What we need is a lab test of the performance characteristics of a similarly melted, cast, and annealed small Apollo sample of real lunar mare basalt regolith. This research would make a great thesis for a student majoring in inorganic materials.

An early lunar cast basalt industry producing abrasion-resistant pipes, troughs, and other parts of sundry regolith-handling equipment would seem to take priority over everything else. We have to handle regolith to produce oxygen, to produce iron and steel, to produce aluminum, to produce ceramics, to produce glass. Regolith-handling equipment will be necessary to emplace shielding, to excavate, to build roads. It will be needed to handle regolith being heated to harvest its gas load of hydrogen, helium, nitrogen. Yes, we could use imported items for this purpose. Yes, we could use nonresistant items and keep replacing them as they break down and wear out. But that does not seem to be "logical." If we are to diversify lunar industry in a logical progression, cast basalt seems the place to start, with an in situ demonstration as task # one.

### Cast Basalt Flooring Tiles

Two companies, one in Britain, one in the U.S., use cast basalt to make "durable but decorative" flooring tiles in a variety of shapes.

- **Greenbank Terotech Ltd.**, Derby, UK <http://www.greenbanktl.demon.co.uk/>
- **Decorative Cast Basalt Sales, Inc.** Webster Springs, WV <http://www.decorativebasalt.com/>

Greenbank Terotech and DCBS import Czech basalt to produce "Volceram [volcanic ceramic] Flooring Tiles" of "natural beauty and practicality." Cast Basalt is now being used extensively by architects and designers for use both as a industrial floor covering in heavy industry and as decorative flooring in commercial, home and retail settings. The skillful 16–21 hr annealing process brings out all the natural beauty that gives the basalt tiles a unique appeal and a natural shine without added glazing.

For commercial and industrial use, their hardness ("four times harder than rock, one of the hardest ceramic materials known") and imperviousness to acid and chemical attack make the 25 mm (1") thick tiles very attractive. They "take a beating," retain their appearance, require little maintenance.

This nonporous "industrial strength" tile is nearly nearly indestructible, and chemical-resistant. Yet in the annealing process they acquires a natural beauty that rivals more common ceramic tiles that have to be glazed. This makes them equally perfect for kitchens, bathrooms, halls, patios, etc. Tiles are produced in standard squares, florentine, charlotte, hex and other shapes, and in several sizes to allow a great diversity of floor and patio patterns.

### Role of Tiles in Lunar Settlements

Modular habitat structures, will have to have circular vertical cross-sections to distribute the stresses of pressurization equitably, whether their overall shape be that of a sphere, cylinder, or torus. This means a flat floor will have to be constructed over a bottom cavity. this dead space could be used for storage, water reservoirs, utilities, and utility runs, etc. -- an efficiently compacted "basement".

An open-spaced flanged-grid subfloor, of some no rust alloy or of glass composite, could rest on metal, concrete, or glass composite joists. The thick cast basalt tiles could then be set into the grid without mortar, as illustrated below.

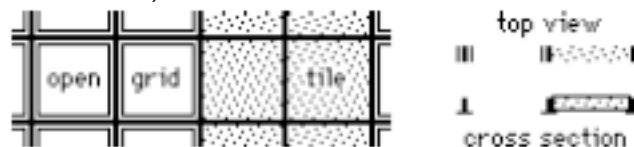

Larger cast basalt tiles could be used for floors of factories, commercial enterprises, schools, etc. And why not also outside, set upon a graded and compacted bed of sieved

regolith, to serve as a sort of porch or deck at EVA airlocks, both personalizing such entrances and helping curb import of dust into the interior. One can think of many uses!

### Cast Basalt Tiles for Walls and More

The floor tile possibilities and applications seem endless. But cast basalt tiles could be used for more than flooring. Without wood for the customary “woodwork”, plain, textured, and/or decorative tiles could be used, in the role of jamb, casing, baseboard, ceiling cove moldings, even wainscoting. In MMM #76, June, 1994, we suggested the use of “ceramic” tiles for these applications:

In the illustration below, ceramic tiles are used to provide trim borders. While the seemingly endless variety in color, pattern, and glazing now available on Earth could not easily be produced on the Moon, a variety of hues from the lunar palette (regolith grays, oxide colors, stained glass colors) should be available either unglazed or in soft satin glazes. Tile in contrasting sizes, and coordinated colors and patterns, would make a good companion wall finish, as would simple whitewash or waterglass-based paint.

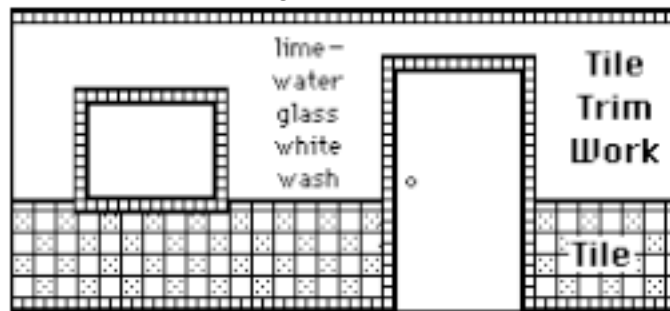

Cast basalt then seems to be the right material with which to kick-start diversified lunar industries. On the Moon, where the regolith particles are quite sharply angular because they’ve never been subject to water- or wind-weathering, we will need a family of abrasion-resistant regolith handling items before we launch our lunar concrete, ceramics, metal alloy, our glass, and glass composite industries. Cast Basalt looms as a cornerstone of lunar industrialization.

Once we have advanced to the processing and manufacturing of these other building materials, we will be able to start providing habitat expansion space from made-on-the Moon materials. Then once again, cast basalt, this time molded into durable and decorative tiles, will help in furnishing the interior spaces of these new “elbow room” modules. Cast basalt will be a cornerstone lunar industry. <MMM>

MMM #136 – June 2000



## NIGHTSPAN LIGHTING: Sulfur Lamps & Light Pipes

By Peter Kokh

Getting through the 14.75 day long lunar nightspans successfully means having enough power to maintain both comfortable living conditions and productive activities. A successful “overnighting” program thus entails these elements:



- available nightspan power either from a power source that is not sunlight-dependent or one that involves a suite of ways to squirrel away overabundant dayspan sunshine for nightspan use.
- finding a way to separate out as much of the energy intensive work load chores to undertake during the dayspan and as much of the energy-light, labor-intensive workload chores to get out of the way during the nightspan. This allows us to get through the nightspan productively with much less power than we use in dayspan.
- designing power-needing systems to be as energy-efficient as possible, thus lowering the threshold for success even further.

One of these "power-needing systems" is nightspan lighting. Using fluorescent bulbs instead of incandescent ones is the sort of thing we have in mind. But now, suddenly, in the past two years, a wholly new lighting technology has begun to come online that can cut the power demand for lighting to only a sixth as much as even fluorescents demand! It is an astonishing development, all by one Maryland company, and one that is ideally suited to a lunar application. Sulfur Lamps working in concert with Light Pipes. It is something to get excited about. Sulfur Lamps – <http://www.sulfurlamp.com/>

- Full Spectrum, like the sun
- Very Stable, both in color and brightness
- Very low UV and minimal IR / heat in beam
- Very Efficient, most efficient source available
- Long-lived, with minimal service requirements
- Environmentally safe, just sulfur and argon
- Quick to start, 100% in 25 seconds
- Operable in any position
- Dimmable to 20%, and maintains color
- Very consistent in performance, from unit to unit

The light source is an electrodeless sulfur lamp, invented in 1990 by scientists working for Fusion Systems Corporation in Rockville, Maryland. This technology is now being developed exclusively by a new company, Fusion Lighting, also of Rockville. In the next two years, the lamp is expected to find its way into a wide variety of applications: large interior spaces (factories, warehouses, arenas, shopping malls) as well as for architectural and security lighting. Two lamps and a single light pipe at the Forrestal Building are replacing almost 300 conventional lamps, ballasts, and fixtures.

At the National Air & Space Museum, overall light level has been increased fivefold, unwanted ultraviolet cut to almost zero, shadowing reduced, and color improved -- all with a 5/6 ths reduction in energy consumption. Given their small size, sulfur lamps are ideal for use as "light engines" for special fiber-optic uses as well as general lighting.

The negatives appear to be low. The system uses sulfur rather than the mercury used in all other high-wattage lighting systems. The disposal of the bulbs will be no problem for the environment. The bulbs may never need to be changed. Because there is no filament or electrode, there is nothing to burn out or break. The magnetron used to power the lamp will need to be replaced after fifteen to twenty thousand hours of use. The lamp is designed to make this changing easy. But the expectation is that these will be superseded by solid state devices to give the lamps an almost indefinite useable life.

What about lunar agriculture applications? The lamp has been well received by Agriculture Dept. scientists looking for ways to use this energy-efficient source to grow plants in the laboratory. One big advantage here is that the sulfur lamp has bright, full-color characteristics just like the sun. Fluorescents and other high-intensity discharge lamps, emit only bits and pieces of the full color spectrum. In a graph of light output versus wavelength (color), the output from the sulfur lamp coincides closely to sunlight over most of the visible spectrum.

Truer sunlight quality may also be invaluable for frontier psychological health. Indeed, there has been high interest in sulfur lamps from Scandinavia where the winters are long and dark.

How do they work? Argon gas in the bulb is ionized by the microwave field and absorbs energy which is then transferred by collision to the sulfur molecules which, in turn, are heated, excited and emit light. Krypton would also work. The lamp is rotated to cool the bulb and also to mechanically stir or mix the plasma. The bulb weighs so little that only a very small motor with negligible power draw is required to spin the lamp.

The argon and sulfur do not dissipate with time. Nor does the light deteriorate as with fluorescents or HIDs. The most popular fluorescence put out about 81 lumens per watt. The current sulfur lamp is at 95 LPW at the wall plug with new ones over 125 LPW available soon.

You can't go out and buy a sulfur lamp just now. The LightDrive 1000 and the Solar 1000 models used in tests to date have ceased production. The next model is still in R&D with no scheduled release date. According to Fusion Lighting, the future will bring even better all around performance.

### Light Pipes

Light pipes are a delivery system not unlike "drip irrigation." Their whole function is to deliver light wherever needed, in the amount needed. Use of light pipes greatly reduces bulb replacement labor.

The 3M Corporation has taken the lead in developing and commercializing light pipe systems. We had reported on the usefulness of the new technology on the M (354 hours of guaranteed cloud-free dayspan sunshine) in MMM # 66 p.7 June 1993, "Let There Be Light: light delivery systems for lunar settlements need to be rethought."

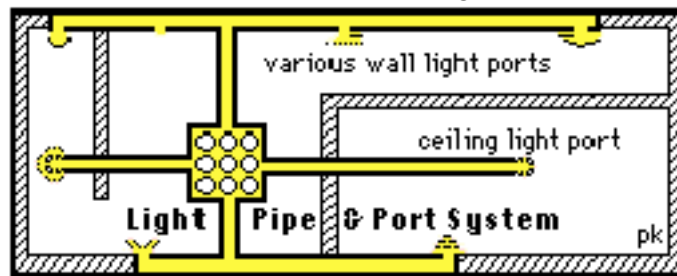

The recent development of Light Pipe technology suggests an altogether different approach to indoor lighting on the Moon. Instead of a multiplicity of individual lamps and light fixtures, a network of Light Pipes whose rib-faceted inner surfaces channel light without appreciable loss to locations remote to the light source could be built into each building, ending in appropriately spaced and located Light Ports.

A central bank of efficient high-pressure lunar-appropriate sodium vapor lights could feed the network during nightspan, sunlight feeding it by dayspan, to form an integrated light delivery system, part of the architect's design chores.

Delivery Light Ports could be concealed behind cove moldings to produce ambient ceiling illumination or end in wall ports that could be mechanically variably shuttered or dimmed from full "off" to full "on". If the reverse side of such shutters were mirrored, the 'refused' light would just go elsewhere and not be lost. A low voltage feedback loop could match supply, the number of central bank lamps "on", to the number of Light Ports open.

Wall and Ceiling Light Ports could then be fitted with any of a growing choice of consumer purchased and artist designed decorative plain, etched, or stained glass; pierced metal diffusers; or fiberglass fabric shades. Such a system might allow the number of types of bulbs that need to be manufactured to be minimized, allow the use of the most efficient bulb types, appreciably reduce the amount of wiring needed, and still allow wide decorator choices.

The exciting good news is that now, all of a sudden, we have a much better option than the "high-powered sodium lamps" suggested above. The sulfur lamp bulbs deliver much more



light from a much more compact golf-ball sized source. The smaller the bulb, the easier it is to mate with light pipe distribution systems. Light pipes driven by sulfur lamps are suitable for low and high bay uses requiring high quality, low shadow light such as factory floors, sorting facilities, inspection bays, and limited access areas. The new sulfur lamps have been used with light pipe installations in post offices, train stations, clean rooms, large freezers, auto manufacturing plants, aircraft hangers, and highway signage.

Advantages of light pipes are low maintenance cost and the nonintrusive nature of lamp maintenance. This is still a new technology and improvements in performance and lower price can be expected.

### Other Useful Light Delivery Systems

Another way to deliver intense light evenly over a large area is to use a central kiosk under an arched ceiling or to a special overhead diffusive reflector which provides uniform illumination to the floor area. Other installations in Sweden use wall mounted lamps that direct light to specially placed specular reflectors for general and special lighting needs. Directing light toward a reflector is best for low maintenance, limited access installations that need good efficiency.

### For us, the Bottom Line

Both sulfur and argon will be reasonably easy to process from lunar regolith, and that will make lunar self-manufacture possible when settlement growth makes it economic to do so in comparison to continuing importation. The new sulfur bulbs have only very long lasting components and are so efficient that lunar nightspan sulfur lamp lighting systems will only need a fraction of the energy we had previously expected to have to devote to this purpose.

As nightspan power generation is very much an “uphill” effort, the fortuitous development of these two well-matched systems is thus very encouraging. Men have never “overnighted” on the Moon. Now we have less reason to “fear the dark.” <MMM>

### The World's Largest Sulfur Lamp [www.af.mil/news/Sep1998/n19980921\\_981433.html](http://www.af.mil/news/Sep1998/n19980921_981433.html)

Hill Air Force Base, Utah (AFNS) 21 Sep 1998: After years of planning, a demonstration of the world's largest sulfur lamp installation opened here. It features 288 energy efficient lamps with a 10 year life expectancy, covering a work area in a hangar the size of two football fields. The base expects to realize a savings of \$57,000. The project's biggest benefit is expected to be a better quality of life for the employees who work in the hangar under the softer, more sun-like light.

PK

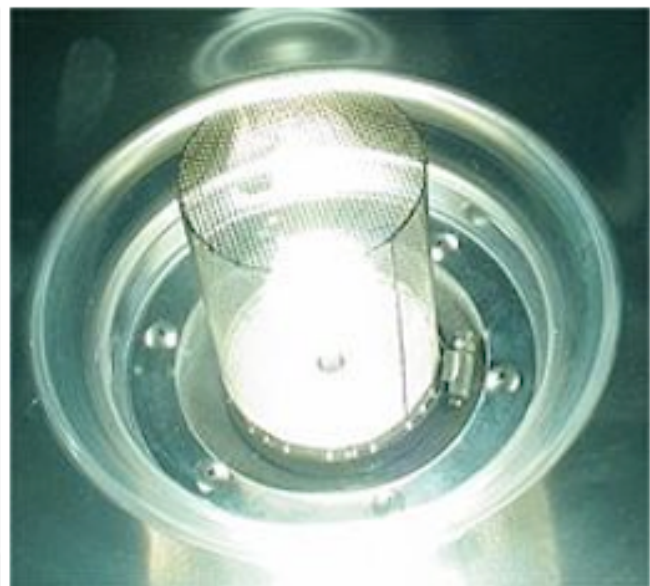
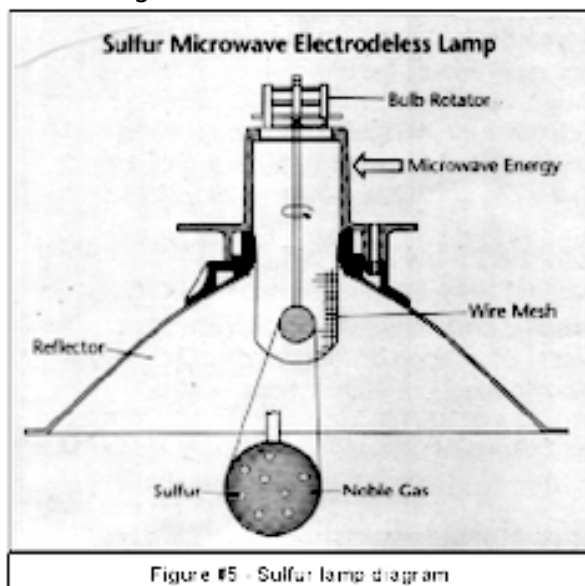

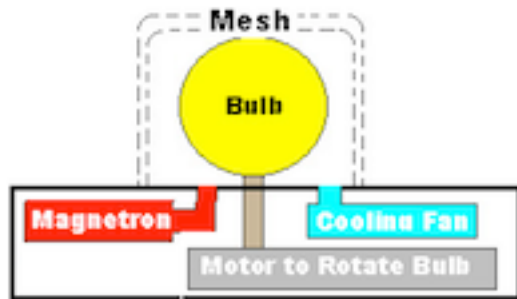

## MMM #137 – August 2000

### Escape from “Mole Hill City”

Modular construction with interlinked regolith-shielded units (L) seems the best way to grow a lunar settlement in open-ended fashion. But how do we graduate from “Mole Hill City” and reclaim the surface? For a fresh architectural approach (R), see below.

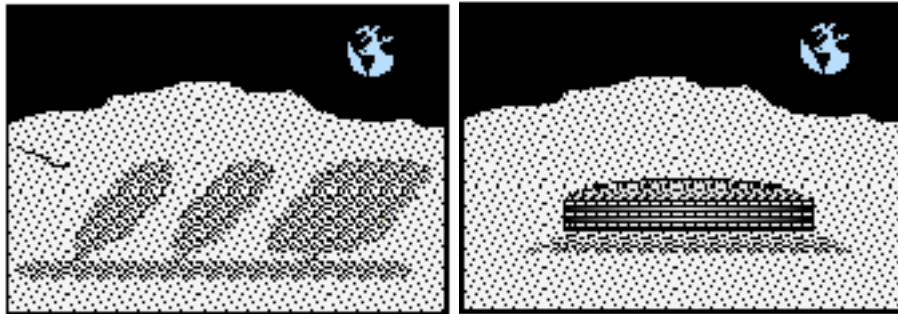

## Taking Back the Surface: Above Surface Architectures for Moon and Mars Habitats

By Peter Kokh

### Background Readings from MMM Back Issues

- MMM #1 DEC '86, p 2, “M is for Mole”  
– [http://www.moonsociety.org/chapters/milwaukee/mmm/mmm\\_1.html](http://www.moonsociety.org/chapters/milwaukee/mmm/mmm_1.html)
- MMM #55 MAY 1992 p 5. “Skyscrapers on the Moon?; p 7, “Moon Roofs”
- MMM #75, MAY '94 pp 4–7, “A Successful Lunar Appropriate Modular Architecture”
- MMM #109 OCT '97, pp. 3–11 “Luna City Streets” specifically, pp. 7–8 “Custom Frontages”
- MMM #111 DEC '97, pp. 4–5, “Lunar Skyscrapers: shattering ‘low’ expectations”
- MMM #122 FEB '99, pp. 5–7, “Shielding: the ‘B’ Options”
- MMM #125 MAY '99 pp. 3–4, “A Levittown on the Moon”

### Foreword:

The spirit of the “Manifesto” in MMM was born the instant I walked inside an innovative earth-sheltered home, “Terra Lux,” some 30 miles NW of Milwaukee in the rolling glacier-carved Kettle Moraine countryside of SE Wisconsin in the Spring of 1985. Eight feet of soil and grass covered the concrete ceiling, and only the garage door was exposed. Yet I was standing in pools of bright sunshine and looking straight ahead out onto the green meadows through picture windows in the walls. The sun came in through mirrored shafts. The views also were channeled down a shaft via a pair of very large mirrors on a 45 degree slant. That you could use

devices like this to bring the joys of surface life down underground with you was a revelation. On the Moon and Mars, exposure to the waves of cosmic ocean weather pounding on the barren global coast meant refuge under a blanket of moondust or Martian regolith. Yet we could be comfy.

But the regolith serves as a blanket with this difference. While we live below a blanket of air on Earth we still live above the visual surface. On Moon and Mars, the surface of the regolith blanket IS the visual surface. It is one thing to find ways to enjoy access to the sun and views. But perhaps many Lunan Pioneers will still regret, even resent, the “loss” of the surface from which radiation, solar flares, and other cosmic inclemencies would seem to exile us. The rebel cry will be to “take back the surface.”

In these pages we have tried to sketch a rich and varied menu of supportable “out-vac” activities including sports. And we’ve suggested ways in which our settlements could still have “skyscraper”-jeweled centers. And we’ve illustrated how lavatube settlements could boast elevator shafts to surface observation areas and surface-side restaurants.

### **Inspiration in Utah:**

It was early afternoon on a hot summer day in Utah. I had been immensely enjoying my window seat view of the Colorado Rockies and the Utah rock scapes along Interstate 70, this past July 20th (2000.) This treat of exploration was a fringe benefit of going by “covered wagon” -- Greyhound -- to the Las Vegas opening of the Moon Society Organizing Conference. Colorado’s Glenwood Canyon, and its feat of Interstate engineering was fresh in my mind as the scenery started to get fantastic again west of Green River, Utah.

Following on my road map, I imagined myself on Mars as we cut through the San Rafael Reef (where there had been no road at all prior to I-70). Then we entered a broad valley with sweeping views -- Castle Valley between I-70 exits 100-114 (approximately). I didn’t have to wonder long at the origin of the name. To right and left there appeared one butte or mesa after another, each of them with rusty ochre rock cliffs bearing a very pronounce horizontal stratification along with texturing vertical lines cut by falling water and erosion. The tops were covered with desert soil. And a fairly uniform talus slope of erosion debris gently bermed these “castles” so they seemed to be extruded from the valley floor itself. I could imagine the geology that created these features and will make it a point to research that in detail.

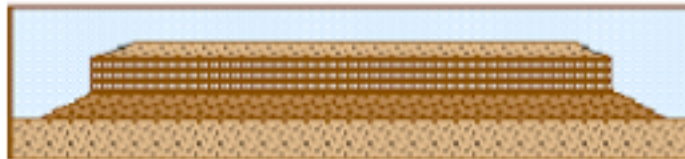

As the majority of my fellow travelers slept or read or looked the other way in inexplicable boredom, I was cycling between visual ecstasy and brainstorming imagineering of fully shielded surface homes on Mars and the Moon. The vertical walls with their strong horizontal character were retaining walls taming the regolith that safe-hid homesteads inside. We could transcend the mole hill, and reclaim the surface -- with strong architectural character!

In MMM # 122 FEB '99, pp. 5-7, “Shielding: the ‘B’ Options”, I had talked about one similar way to contain and sculpt regolith shielding mound.

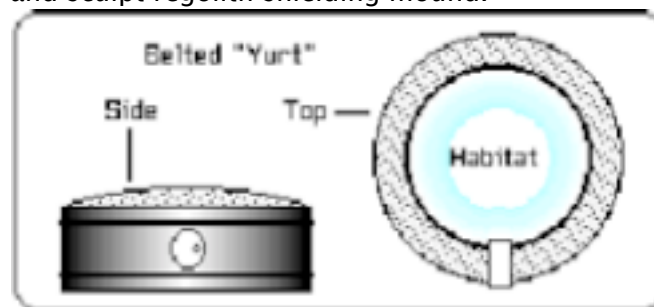

While the structure of what I was now seeing so vividly in my mind's eye was much the same, the idea of the retaining wall being made of rock or cast basalt or concrete forged out of the local regolith, paying homage to that origin in its coloration, and being so strongly textured as to give equal testimony to the host planet and to the intelligence that now adopted it as "home" -- that vision was fresh flash.

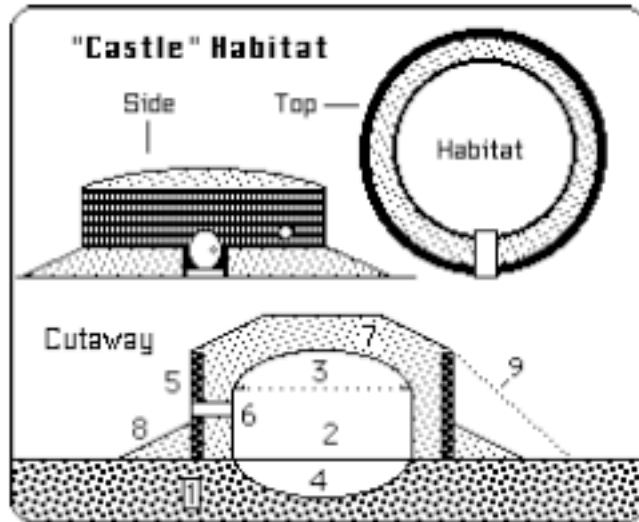

**KEY:** (1) surface, minimally excavated to nest the rounded bottom of habitat hull; (2) Habitat Hull, in this case a squat vertical cylinder with round end caps; (3) vaulted, cove-lit ceiling; (4) "basement" area for utilities and systems and extra storage; (5) the "castle" rampart retaining wall; (6) shaft for "window"; (7) regolith shielding and (8) berm slope of shielding without a retaining wall

The retaining wall is shown above with a berm of regolith around its periphery. This berm is not dictated by either structural or shielding considerations, but rather by aesthetic ones. Without a berm, the habitat appears to be a foreign object alien to the Moon (or Mars) and just "dropped or set out upon" the surface. With the berm, the habitat appears to be a natural extrusion from the surface, just as the castle rock outcrops in Utah seem to be (and are) a natural part of their valley. And that is the whole point. Our goal is an architecture that "takes back the surface" without "assaulting" it: "selenophylic" architecture for the Moon; "areophylic" for Mars.

In some areas the lunar surface has been "gardened" into regolith by eons of micrometeorite bombardment to a depth of up to five meters (16 ft.) In other areas the loose moon dust gives way to broken bedrock only a few feet down. In terrain like that, this surface "castle" shielding construction method might actually work more "with the grain."

### Openings to the outside

This type of surface construction lends itself more easily to individual home air-locks and vehicle docks to the surface, though one could still choose to rely on public access points, e.g. along pressurized city streets. What about windows? In "castle wall" construction, the habitat is actually at or above eye-level with the surface. The "periscopic" picture windows suggested for "buried" habitats might seem out of place (even given the higher vantage point. Friesen talks about an alternative movable shutter system that might work well for our "above surface" castle homesteads. Yet one might still opt for dumb (no moving parts) sight path shielding via a "sideways periscope." An illustration of a horizontal zigzag light shaft is shown at left, below:

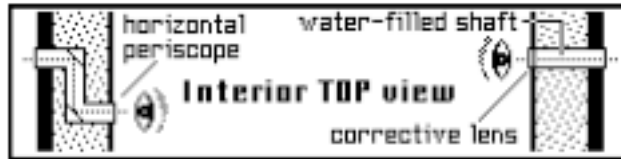

Right, above: Advanced possibilities include a water-filled shaft, with active thermal and density management to maintain structural integrity.

**“Castle” Retaining Wall Materials:**

A showcase vertical retaining wall can be built of various “lunar” or Martian materials:

- Metals: cast iron (rust free in vacuum), magnesium (nonoxidizing in vacuum), etc.
- Concrete: fiberglass (or basalt fiber and/or basalt “rockbar”) –reinforced steam–cast cement
- Sulfur Cement (no water or steam required)
- Sintered Blocks (easy to make but requiring more assembly even with a mortarless lego–type shape)
- Cast Basalt

Metal and Composite panels (e.g. fiberglass reinforced cement and sulfur cement) can be made thinner without sacrificing strength. In light gravity, the outward pressure on the regolith retaining wall would not be especially great.

At first, the components would be made to order by a manufacturer. The first customer might be a wealthy individual (and his/her architect) or, more likely, a major homestead builder–developer who wants something special and distinctive. If and when the settlement begins a major population expansion, manufacturers might arise for whom a variety of such retaining wall panels are a major product line.

**Assembly method**

The ideal “castle panel” is something easy to produce and which requires a minimum of assembly. Arc panels short enough to stack easily and light enough to handle, yet long enough to keep assembly to a minimum, could be “keyed” for easy connection. Below is just one type of “key” design.

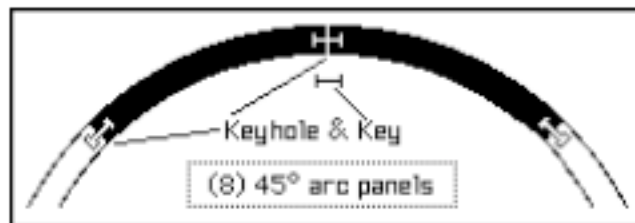

**Appearance: texture, pattern, color, etc.**

A one–step and thus very attractive option would be to cast the panels in textured molds, a common enough practice on Earth for cement façade panels. Such panels could be cast with smooth or rough, vertical or horizontal ribs, each option with a distinctive overall “look” in texture and shading.

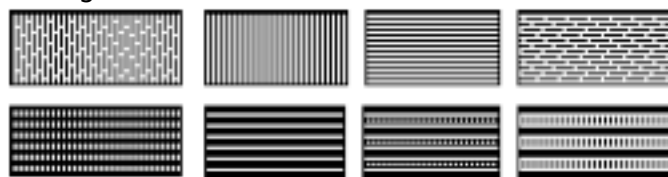

Cement panels and sintered block would take color hues and shades that complement the regolith from which they are made. But they would stand out from the regolith shielding mounds both through their manufactured texture and from their vertical orientation and the play of sun shadows.



Cast Basalt and Cast Iron panels would be rather black; Magnesium silver metallic; Sulfur Concrete a pale yellowish grey. Ochre panels could be made from cast iron panels steam-rusted on the face side in the factory before assembly. It might pay to experiment with various rough texture surfaces to try to find some that would “hold” a dusting of white calcium oxide (lime). A whitewash of lime in sodium silicate would be a more expensive option and may not prove durable under constant thermal stress from dayspan/nightspan/dayspan temperature changes. Concrete retaining slabs could also be cast “smooth” for covering with decoratively glazed ceramic or cast basalt tiles if either the developer or intended homeowner so desired. Possible patterns are endless. Here is but a small teaser sample:

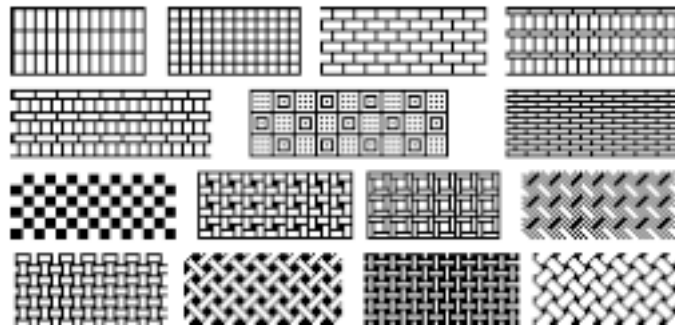

If a non-regolith color palette is used, the color combination options are likewise vast, even if limited to Moon-sourced metal-oxide glaze pigments. These will include black, graytones, and rust shades at first. Later, green, white, blue, pale yellow, and various blendings of the above will be available. Bright red, yellow, and orange would be unlikely.

Preferably, each panel would be “tiled” in the pressurized factory, allowing quick installation with minimum EVA. To put up plain tile-backer panels, pending a later greater selection (e.g. as more color pigments and glazes become available) would allow quicker initial assembly but then look a bit ugly for an indeterminate amount of time. The calculated risk is that custom finish cladding is a “postponable” expense and may never be completed. Perhaps the smooth tile-backer finish could be minimally textured to be presentable ‘as is.’ We want to personalize our homes, not just the sanctuaries inside, but their public faces as well. We previously discussed how their entrances upon the city’s pressurized streets will create opportunities for personalized expression.

In “Moon Roofs,” we described ways people could customize and style the surface of the regolith mounds that protected their habitats. “Castle wall” construction offers us welcome new ways to personalize our homestead “exteriors.”

### **Variations on “Castle Home” Shapes**

This surface-exposed “castle-panel” architecture is not limited to the simple one or two story vertical cylinder type habitat. Go for the layout you want! Then erect a retaining wall that outlines the exterior wall footprint, or one that disguises it.

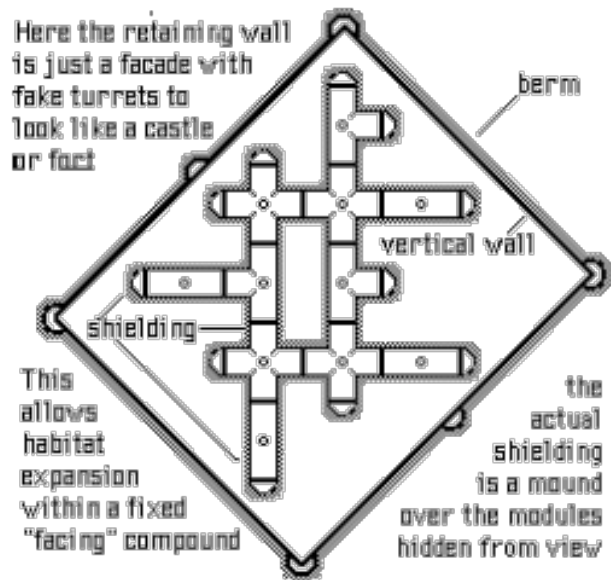
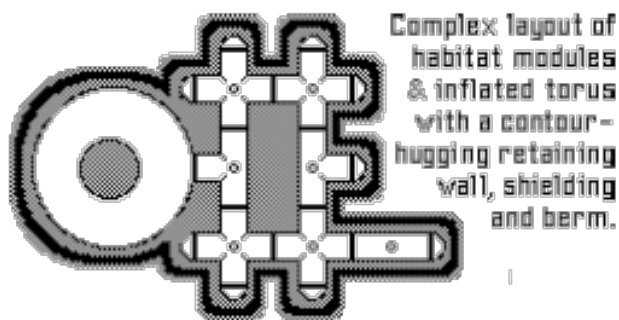

### Doing a whole Settlement or Neighborhood:

Just one residence designed in this manner might look out of place. A whole town of habitats built with similarly textured retaining walls would be rather striking, much as are the Spanish tile roofs of the University of Colorado at Boulder, or the red brick colonial buildings of the Univ. of Kentucky in Lexington, or the adobe buildings of the University of New Mexico in Albuquerque. Keeping to a uniform architectural "language" can yield visually impressive results but yet suffocate the individuality of those who must live in them. In our case, if all the retaining wall elements are similarly textured and colored, this would quite defeat the whole purpose of including a personalizable public facade to one's dwelling – a seeming Catch 22. Somehow I think that the similarity of "above surface bermed homes" will prevail and give the settlement a distinctive feel even if patterns, textures and colors, as well as footprint shapes vary widely from home to home as they should in a healthy and vigorous settlement.

Standards of "conformity" should be very generous in their interpretation. Neighborhoods might well vary in the styles that are characteristic of them. The Home is the very essence of personal expression. It is very important to allow this personality to be expressed on the public exterior as well as in the interior.

Managing shielding "with style" in this fashion might first appear in "upscale" settlement neighborhoods. Or perhaps it will first appear in the isolated inter-settlement and off-road reaches of the endless global boondocks. Indeed, isolated outposts may put a premium on "standing out" against the moonscape, yet "being one" with it. "Castle wall construction" in all its possible varieties should appeal to the hardier breed of "rural" pioneers.

Whether set out on a broad plain or on high ground commanding views in many directions, hotels and inns, general trading posts, and other types of country outposts built in this fashion would catch the eye from afar, welcome tired travelers, and signal the pride within. Wherever it takes hold first, we can expect a lot of experimentation within this paradigm.

### There's more to a town than homes:

Variety versus conformity is not the only issue. "Castle" homesteads must still be connected by pressurized, shielded thoroughfares. These also could be minimally set into the surface with bermed walls taming the shielding mounds.

That might be taking the architectural idea too far, detracting from the homesteads themselves. On the other hand, public architecture could be used to "set the theme" and example for privately built individual homes. That is something Lunan architects and the people who hire them must work out for themselves. And a non-trivial issue is that such features for public assets come with an additional price tag -- additional taxes.

### Conclusions

In the previous articles cited (“Moon Roofs,” “Skyscrapers on the Moon”, “Lunar Skyscrapers: shattering low expectations”, “Luna City Streets”) we had already laid the grounds for considerable diversity and individuality. Both articles dealt with ways Lunar and Martian settlements could escape dismissal (“Once you’ve seen one molehill city you’ve seen them all!”). In this article we’ve tried to develop additional architectural options. Combine that with further options such as lavatube settlements and cities within megastructures, and it becomes quite clear that while all Lunar and Martian settlements will be recognizably Lunar or Martian respectively, it will not be true that once you’ve seen one, you will “have seen” the Moon or Mars.

Earth cities are recognizably “Terran” – they are outdoors in a planet wide biosphere. Yet variety and diversity abound. We think that as the lunar and Martian frontiers develop, initial monotony and uniformity will in time give way to a quite surprising creativity and innovation of expression.

Variety is the spice of life, and we will not lose our need for it by transplanting ourselves to other less motherly worlds. The Moon and Mars similarly challenge us with their lack of breathable atmospheres and exposure to the waves of the cosmic ocean. But there will be more than one solution or set of solutions to those challenges. The easiest is but the first.

Architectural diversity encourages tourism. Visitors from Earth will have several settlements on their itineraries. But it will also be healthy for the settlers. They will have attractive and interesting places to visit, or escape to if only for a badly needed change of scenery, on their new home world.

External shapes and forms are but one vector of cultural diversity. They will be complemented with a diversity of arts and crafts, clothing fashions, performing arts, sports, and more. It’s about making both the Moon and Mars whole new Worlds, “capital W,” each with a “world-full” of variety and diversity to forever delight. The limited diversity of the stark and lifeless landscapes will work to encourage special attention to all these other avenues of making places special and unique.<MMM>

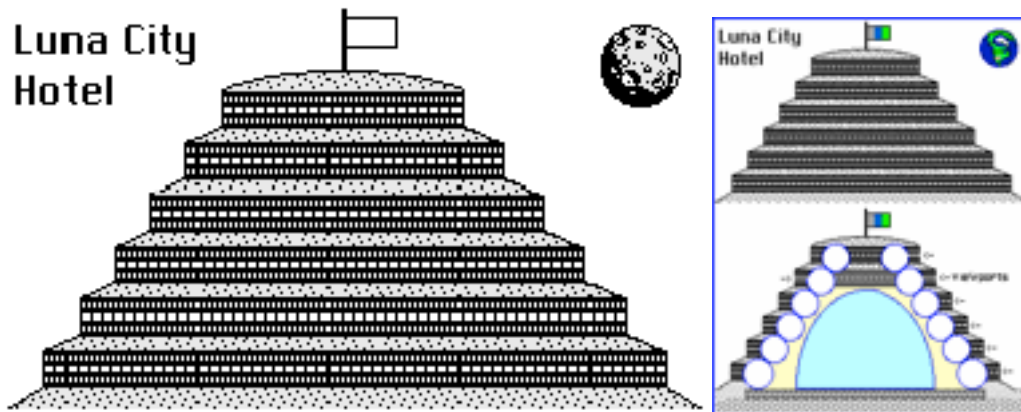

[Behind each textured retaining wall are six 1-3 floor pressurized “donut” rings, envisioned here as encasing a biosphere “garden dome” - illustration by Peter Kokh]

MMM #138 – September 2000

The Black Sky "Blues"



# Coping with “Black Sky Country”

THE BLACK SKY “BLUES” – By Peter Kokh

## Foreword

On Earth we enjoy a brightly illuminated sky. If it isn't clear and blue, the clouds are bright. The darkest storm cloud is far brighter than pitch dark.

On Mars, the sky seems to be “salmon” hued, though there is one researcher who insists that this is only the case during and after dust storms. The point is that on Mars, as on Earth, the daytime sky is a source of diffused ambient light that makes viewing the landscapes easier. Earth and Mars are “bright sky worlds,” a gift of their atmospheres.

On the airless Moon, however, the sky is pitch black during dayspan. In the glare of the unfiltered Sun the naked eye cannot see even the brightest star. During the near-side nightspan, Earthlight will cast a glare from up to eighty times as bright as that of full moonlight on Earth. Even a partially lit Earth will also blot out most of the stars. Only on the lunar farside, forever turned away from Earth, do the stars come out during nightspan – and with a brilliance we cannot imagine. But at no time anywhere on the Moon is the sky itself “bright.”

We've all grown up with the night. We don't mind it. Nighttime darkness is only temporary. With dawn comes welcome visual relief. On the Moon, that relief never comes. Our pioneers will be transplanting themselves to “Black Sky Country.” And that can have long term psychological consequences.

With the black sky even at “high noon”, the contrast volume between surface and sky is intense. Shadows are bottomless visual pits. This will cause some eyestrain. Of course, this will be more of a problem for those who spend a lot of time out on the surface – in the “out-vac”. But it will affect those who spend most of their time in pressurized spaces as well: in what they see through various types of “windows” – vidscreens, periscopic picture windows, etc.); it may affect “skylights” as well.

## Coping with Black Skies

To the extent that the “Black Sky Blues” do become a subtle morale problem, and this may differ from individual to individual, ways of providing deserve serious attention. Here are a few, we can think of for starters (and we invite readers to send in additional suggestions):

- **Electronic Windows** – Whether we call them telescreens, visiscreens, or something else, electronic images of the surface scene outside offer, for good as well as mischief, the opportunity to be manipulated. The viewer may be able to select a sky color and brightness to his or her liking. The viewer, much like an Internet browser, would then “interpret” the black areas at the top of the picture accordingly. Pick a light gray to go with the moon tones, or a smoky blue. Or, if you're a visiting Martian pioneer, a dusty salmon. Those homesick for Earth can pick a brilliant blue. The idea is not to deceive oneself but to prevent eyestrain – if it has become a personal problem.
- **Spacesuit Helmet Visors** – Would it be possible to give the visor some differentially reflective coating that would “brighten” the sky, even if just a bit, without interfering with clarity of visibility of the moonscape? We throw out the challenge. If this proves feasible, could we do something similar with regular windows and periscopic picture windows (Z-views)?
- **Skylights & Clerestory Windows**; On Earth, water vapor in the atmosphere scatters the sun's rays so that light seems to come uniformly from all directions. Our atmosphere is a natural “diffuser” with a bluish cast. For those windows meant to bring in light but not necessarily the views, could we produce some sort of frosted and translucent, but not transparent, glass pane that will not only let in sunlight but appear itself to be bright, giving the illusion of a bright sky beyond? Again we but throw out the challenge. One might experiment by holding up various kinds of existing glass and diffusers to a streetlight against the dark nighttime sky.

Windows, skylights, and clerestories of this type will be desirable not just for private homes but for sunlit pressurized streets and other “middoor” spaces, sports facilities, highway waysides,

etc. Passive light scattering panes to the extent that they present a satisfying illusion of a bright sky could become standard, or at least common.

Without real experimentation, we would not pretend to guess what will work best. But we should be trying a lot of things, including foamed glass, aerogel, special coatings or laminate layers, etc.

Meanwhile, this standby: Some may not want to wait for such *tromp d'oeuil* developments, or disdain them as dishonest. And it may turn out that none of these suggestions will be possible to realize in a truly satisfying way.

There is another, simpler way. Pressurized habitat structures and modules will commonly have curved surfaces. We'll need to install flat floors, of course, but the curved ceilings of spheres, cylinders, and toruses present an opportunity. Finish them with a light-absorbing matte texture and illuminate them with cove lighting. Give the finish – or the light source – a subtle blue cast, and *Voilà*, the appearance of blue sky. That these vaults offer greater ceiling height will only enhance the effect.

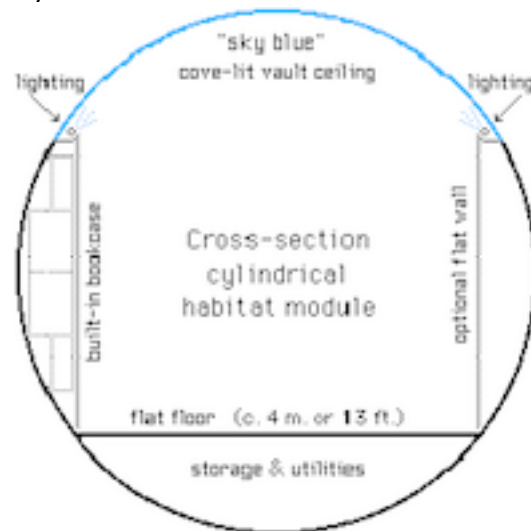

We can in effect, recreate the familiar blue sky indoors on the Moon. On Earth, where all we have to do is step outside, this hardly seems like a worth-while extra expenditure. On the Moon, suggestively bluish cove-lit vault ceilings may become the norm.

Cove lighting, especially if it is really “sky-bright”, will reduce the need for other lighting: floor and table lamps, wall sconces, and especially ceiling lights and chandeliers. Strong indirect ambient light reflected everywhere off the vault ceiling from cove light strips hidden from view will create a positive psychological “atmosphere”.

It's understandable if some residents might prefer the flat, white ceilings they are familiar with on Earth and to get their daily dosage of blue skies in common “middoor” spaces such as pressurized roadway tubes. Below is a suggestive illustration from MMM # 53 March 1992.

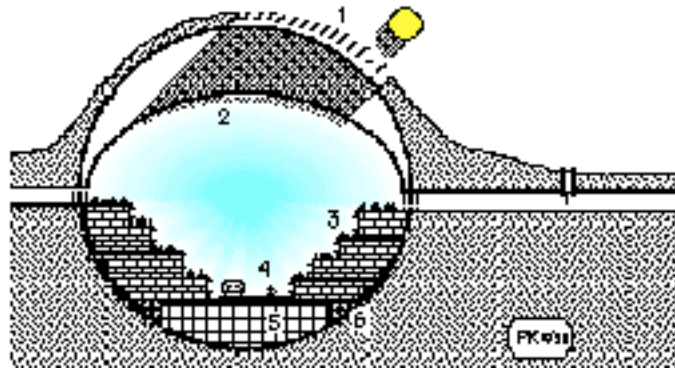

### THE RESIDENTIAL STREET ('HOOD) AS THE MODULE

#### Cross-Section of cylindrical module 40m x 700 m:

[1] shield louvers let in sunlight; [2] suspended sky-blue diffusing "sky"-air pressure same on both sides; [3] terraced residential housing with rooftop gardens; [4] thoroughfare running the length of the (neighbor)'hood; [5] light industry, shopping, offices and schools; [6] conduits for utilities.

At first, roadway tubes will be of a much more modest scale, of course. But other "mid-door" spaces (pressurized common spaces neither inside private quarters nor "out-vac" on the surface) such as school recreation spaces, public squares, sports arenas, and "park and picnic areas within agricultural modules all are prime opportunities for faux blue sky ceilings. During the two week-long nightspan daylight (on an artificial 24 hour schedule) could be simulated by using electric cove lighting aimed at such vault ceilings. During the equally long dayspan, sunlight could be indirectly channeled by mirrors to reflect on the vault-ceilings full-time, or shuttered to simulate night conditions on a 24 hour schedule.

#### Blue Sky Simulations Out-vac

What about simulating blue skies outside the settlements, out on the surface? This might be very desirable for frequent inter-settlement travelers, truckers, and others whether they spend a lot of time in such conditions or not. Certainly, one could design emergency solar flare shed vaults and other covered roadsides, even if unpressurized, lit from below, thus providing "bright skies" of a sort, whether they be blue, white, or light gray.

One can foresee a day when many thousands of people live on the Moon in several settlements. There might then be one or more heavily traveled surface corridors. These could be covered with shielding vaults lit from below, open to the vacuum. Such lunar "superhighways" would make for safer, more comfortable driving conditions, day or night.

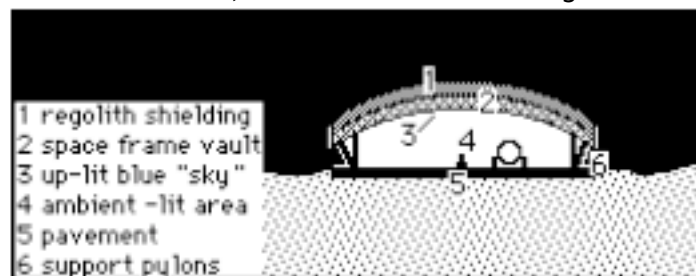

Someday, settlements may be built within great megastructures with soaring ceilings. These too could be designed to offer bright blue skies. But meanwhile, the use of cove-lit vault ceilings in habitat and other interconnected settlement modules will go a long way to shake those "Black Sky Blues" or at least help inoculate the settler pioneers against the accumulative visual deficits of the "magnificent desolation" of the lunar terrain.

But hopefully, someone will pick up on the other challenges we've put forth, of individually tunable "browser-like" video screens, special light scattering glazing options, and smart helmet visors.

The "Black Sky Blues" is something we need to take seriously. It poses an acculturation challenge unique to the Moon and other airless worlds which future Martian settlers will not have to face. <MMM>

MMM #145 – May 2001

## Murphy Beds & More on the Space Frontier

### Multi-Function Living Spaces in Space Frontier Private Quarters

By Peter Kokh

At the current "toe-in-the-water stage of "space settlement," "personal quarters" are spartan to say the least. Aboard the shuttle orbiters, sling hammocks attached to a handy wall are as coddling as they get. Aboard ISS, telephone-booth-sized personal berth cubicles are still just a promise, given the recent cancellation of the U.S. Habitat module.

Crew tolerate such conditions well for the relatively short periods of time they are on location. Given ample experience in submarines and other naval ships, that comes as no surprise. Yet astronaut duty is not supposed to be military duty, and morale is not served by lack of private quarters for people on extended tours. We are each private persons and need periods of time and reserved spaces in which to escape from duty and communal life.

"As soon as it is practical to do so," spaces each can call his or her own should be provided. Places one can decorate with items of personal value and fitting personal taste. Places in which one is king or queen – cubbyholes in the world which are extensions of ourselves. Places in which no one else is welcome uninvited. Places which are not common.

At first the mini-berths planned for the ISS habit modules will do. Indeed, they will be an enormous improvement. At the other extreme, long down the road of maturing space settlement, we may someday be able to provide ample living spaces for pioneers built in modular fashion from locally produced building materials. Here, on the Moon or Mars, as expansion of pressurized structures is difficult, it will be wise to provide at the outset, all the square footage a large family might want, growing into it over time, finishing it off as needed, renting out unused space being an option.

While this should be the carrot we hold before ourselves, we are not going to reach that state right away. Living Spaces will be much smaller than current North American standard (750 sq. ft. per person). This may take some revolution in the way we handle floor space today. It is common in American homes for each function to have its own dedicated space or room, whether that function is exercised for several hours a day or infrequently. It does not concern us that most of the space in our homes is unoccupied most of the time. It is there when we want it. That is the kind of luxury which we are unlikely to be able to afford on the early frontier.

#### **The Size of Lunar Homes – the "Great Home" Concept**

MMM #75, MAY, 1994, pp. 4-6. "A Successful Lunar Appropriate Modular Architecture", page 4: [republished in MMM Classic #8]

Considering that lunar shelter must be overburdened with 2-5 meters of radiation-absorbing soil, and that vacuum surrounds the home, expansion at a later date will be

considerably more expensive and difficult than routine expansion of terrestrial homes. Better to start with “all the house a family might ever need”, and grow into it slowly, than to start with initial needs and then add on repeatedly.

Extra rooms can, of course, be blocked off so as not to be a dark empty presence. But they can also be rented out to individuals and others not yet ready for their own home, or waiting for one to be built. The extra space could come in handy for startup cottage industry before the new enterprise is doing enough business to be moved into quarters of its own. At the outset, with every available hand employed in export production, the demand for consumer goods, furnishings, occasional wear, arts and crafts, etc. will have to be met in after-hours spare time at-home “cottage industry”. The lunar “Great Home” could meet this need elegantly.

Time for an attitude change! Take a look at the various rooms in the usual types of homes or apartments. Part of the floor space in each room is occupied by items that make

- Beds, etc. in bedrooms
- Cabinets and appliances in kitchens
- Water closet, sink, shower/tub in bathrooms
- Table and chairs in dining rooms
- Sofa and easy chairs in living rooms, etc.

The space not occupied by such furniture and furnishings is for walking around and through. In the “efficiency apartment” or “studio”, in which some of us have paid the dues of our “independence,” the idea is to provide the furniture in compact interchangeable ways, sharing common floor space, in a multifunction space. The room will have a day bed, a futon, a sofa-bed hideaway, that provide living room seating by day, reasonably comfortable sleeping by night. The kitchen will be all on one wall, or at most, a small “galley”, enough for one at a time use.

In short, an efficiency is a single room or room and a half with bath, in which all the walk-around space is shared, and the furniture is either compacted or multifunctional. One space serves as bedroom, living room, dining room, etc. Perhaps the epitome of efficiency living is the Murphy Bed\* or “wall-bed”, a full-size bed which pulls down from a wall-cabinet or closet. When not in use, it is out of sight, taking up only hidden space.

There are also dining room sets which fold up into small consoles that can be used as desks. It is this kind of inventive multi-functionality that may shape frontier private quarters in the early periods. By today’s standards, such compact “efficient” living, hardly meets “dream home” standards. But in fact, compacted multifunction living space just takes a little getting used to. It provides privacy, supports all one’s at-home activities, and becomes a sanctuary in which we can express our personalities.

Call it 3-shift usage of space. Where space or equipment involves high capital cost, the only way to make it affordable is to see that it is used as in as time-intense a manner as possible. Thus on the space frontier, we’ll need to shed our current unexamined dayshift chauvinism to arrange living, work, and play patterns so that facilities as factories, schools, parks, and other common spaces are in use around the clock.

That brings down their per hour cost of use to a third. Or, conversely, we then need only a third as much factory capacity, school rooms, parks, etc. For our private living quarters, it may be our only affordable option to adopt a similar philosophy of squeezing the most livability out of minimal space. We are used to efficiencies for singles. Adapting the concept for families will take some doing.

Pushing the concept to the fullest, each wall would hold the collapsed elements to serve a particular room usage. These would extend, pull out, or pull down to turn the common floor space into a specialized living space. There would be a bedroom wall, an office-den wall, a living room entertainment wall, a closet/storage wall, plus a semi-separate “necessary room” pullout.

A vertical cylinder shaped module could have an internal hexagonal shape with six “roommaker” wall units (not of wood!) Exercise centers and additional guest bedroom walls are options. Not every efficiency home need be the same!

One thing is sacred. To serve as a home a dwelling must be able to express the personality of its occupants. It must be customizable both as to its external façade and as to its internal decor. In that respect, homes on the frontier will be no different.

**Habitat module end cap options from MMM # 75**

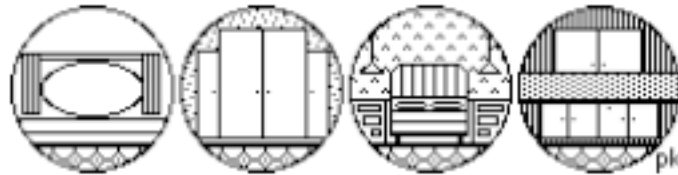

Some of these ideas may prove impractical or only be realized in less than satisfactory fashion. Nonetheless, this may be one direction in which early pioneers will have to exercise their resourcefulness in search of some of that “home sweet home” contentment and satisfaction. From time immemorial the humblest of homes have been homes nonetheless, serving to anchor the lives of those it harbors.

On the Moon and Mars we must start somewhere. How could those going first be ‘pioneers’ without some great hardship to describe to their grandchildren? <MMM>

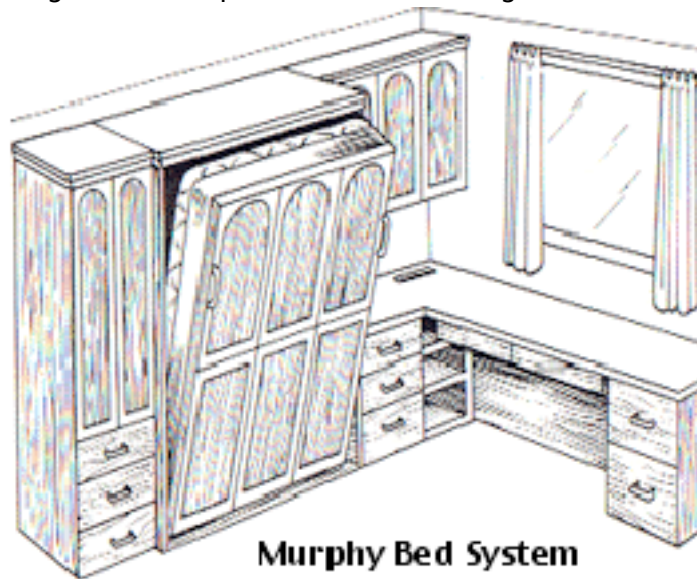

**Murphy Bed System**

<http://www.murphybedcompany.com/history.html> - <http://www.wallbed.com/images/bav6.gif>

**MMM #146 – June 2001**

**Urban**  **& Settlement Style**  
URBAN LOFTS & SETTLEMENT STYLE By Peter Kokh

## **Part 1. Decorating Styles common in Urban Lofts May offer us a Preview of Lunar Habitat Interiors**

“Lofty Ideas” is a weekly program (hosted by Katherine Stone) on Home & Garden TV (HGTV), a cable station offered by many cable networks. For those contemplating moving into an “urban loft” in a recycled old factory or warehouse, and for those just intrigued by the idea, this show gives a fascinating look at how a new generation of “urban pioneers” are making themselves very much at home, thank you, in the heart of cities once being abandoned in droves by residents not up to the new frontier challenges. Lofts characteristically retain the relatively high ceilings of floors formerly given to manufacturing and warehousing. The interior surfaces of outer walls of lofts commonly consist of exposed brick, concrete, concrete block, and other “industrial” materials, unfaced with plaster or drywall or paneling – those more “civilized” interior surfaces all-but-universal in more “traditional” residences: single family homes, town homes, condominiums, apartments, duplex flats, etc.

Floors are commonly concrete or refinishable wood plank with a healthy hint of industrial wear and tear character worked in. As purchased by their new occupants, lofts also most commonly boast exposed heating ductwork, plumbing pipes, and electrical wiring. And most new loft dwellers choose to keep it that way. To this shell which most lovingly accept, they may or may not add dividing walls (seldom full height), partial step up floors (a loft within a loft, e.g. for a bedroom) window and floor treatments and furniture and accessories. The extraordinary amount of highly personal creativity demonstrated in the half hour episodes of “Lofty Ideas” week after week is utterly amazing. For loft-aficionados, this is where it is at.

### **What has all this to do with future frontier settlements on the Moon?**

It occurs to me, that some of the “styles” we see emerging in this new residential medium, will also prove to be the most appropriate, the most efficient, and the most economical, once we are manufacturing modular housing shells on the Moon, for pioneers to turn into “home sweet home” oases in this magnificently desolate new setting. The reason is simple. Adopting the “as is” inner surfaces left by construction of pressure hull habitat modules removes the labor-intensive burden of giving them a faux finish, e.g. plaster or wall board plus paint or paper or paneling. The settlers need to save their free time for where it counts.

### **Let's take a look The Shell (or hull)**

The Moon is well-endowed with the all four of the so-called engineering metals: iron (steel), Aluminum, magnesium, and titanium. Metal alloy pressure hull modules are a primary option for the lunar architect and module manufacturer. Lunar concrete, reinforced with steel rebar or glass fibers to give it strength under tension is certainly another. Glass fiber/glass matrix composites are a third. Surface treatment options available to the architect depend both on the character of the material, and on the manner in which the pressure hull is fabricated.

If the hull material is poured wet, and/or hot, into a prepared mold, its surfaces will take on the character of the surfaces of the mold into which it comes in contact and by which it is constrained. Molds can be smooth, textured, embossed, or carved to create surfaces with special design characters.

In the case of concrete, if coarse aggregate is used, and the surface of the cured cement abraded somewhat, the aggregate with all the character and variation it may have, is brought to the surface. If this is not done, character can be imparted by the mold itself. You may have noticed the clear telltale imprint of plywood forms on poured concrete walls. If the form, of whatever material it may be, is given deliberate texture or pattern – and the possibilities are virtually endless – that texture or pattern will be transferred to the surface of the cured concrete.

This option can be used to endow surfaces with random or repetitive design patterns. I have seen a basement wall of poured concrete that looks like brick, thanks to the pattern worked into the pouring forms. With two inches of styrofoam bonded to the outside, the result is an instant “recreational-worthy” surface. Surfaces with leaf patterns, coarse cross sawn wood patterns, almost any kind of pattern is possible with concrete. Colored concrete sidewalk pavers



with embossed patterns are also appearing. As are concrete shingles that look like cedar shakes. It seems that concrete can mimic almost anything.

We can speculate how we might fabricate habitat pressure hulls from glass composites, but until we have proven, debugged methods and options, we can only guess at the design possibilities. That we can texture the surface seems likely. We may be able to etch it, applying resists and sandblasting. We might be able to color, even grain glass composites, by embedding colored glass fibers in either a random or “raked” pattern in a clear glass matrix.

Metal plate and sheet can easily be embossed, but perhaps only coarse pattern can be imparted to poured metal by mold forms. These uncertainties aside, the use of mold forms in habitat module fabrication and manufacture are a primary opportunity for textural choices with the goal being to use the resulting interior surface as decor in itself, not as a substrate for some hiding faux surface treatment.

Construction-processed surfaces might then subsequently have any mold imparted patterns or textures enhanced by several means.

- Wall washer lighting can enhance textural shadow patterns
- Colored bulbs or colored glass diffusers can wash textured surfaces with color tints.
- Time-based whitewashes or Titanium Dioxide should soon be available to beat the concrete gray blahs.
- Perhaps “stains” using metal oxide pigments might be used to highlight textural surfaces in directional patterns, depending on means of application

What we are talking about is principally the interior surfaces of the exterior pressure hull. In one-story modules, that includes the ceiling, which, if of concrete, may commonly be whitewashed.

Our point is that here is a method of instant “direct decor” in which the architect and purchaser have many options to choose from, simply by allowing the character (the “grain” as it were) of the chosen hull material to give an “encore performance.” By choosing any of these direct decor options, the lunar habitat is finished and ready for occupancy much sooner. Then any sweat equity required or volunteered on the part of the frontier homesteader can be postponed, saved for other things and features to be added as time, energy, and funds are available.

On the Moon we cannot afford to have housing units “under construction for months.” The ideal groundbreaking to occupancy-ready interval should be much shorter, week at most, but with the ideal of “in one day” ever the target. Construction in vacuum is a risk-involving activity and we want to do it in as manhour-light a manner as possible, reserving man-hour-intense activities for optional interior customizing at leisure.

### Hull Details

“Trimwork” (akin to our “woodwork”), if any is desired on interior hull surfaces, can be of sheet metal, ceramic tile, or glass composite, depending on the hull material (alloy, concrete, glass composite.) This trimwork can be of colors and shadings that blend in, compliment, or contrast with the substrate. Glass and ceramic glazes are made with metal oxide pigments, many of which are lunar-sourceable. Steel trim could be rust-finished or even stainless.

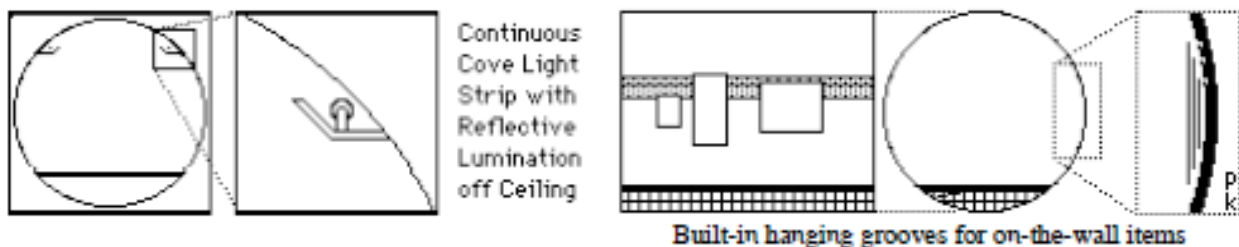

Built-in hanging grooves for on-the-wall items In addition to surface texture, pattern and detail, functional features can be built into exterior hulls, such as coves to hold ceiling

wash lighting, chases for electrical wiring or conduit, and well-placed purchase points for hanging shelving, wall art, etc. The built-in features also serve to shorten the construction to occupancy interval. Even bench or banquette style seating can be provided as desired.

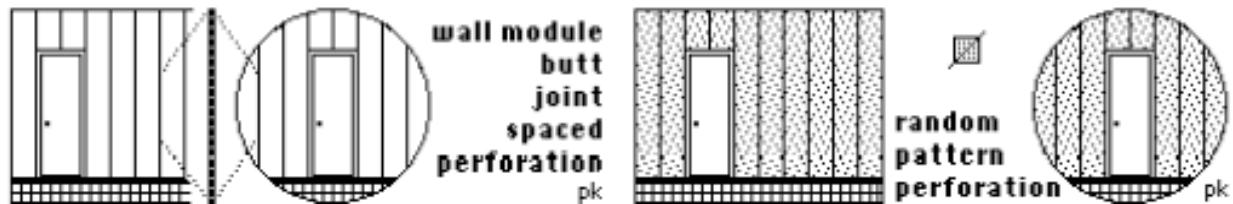

### Interior Wall and Floor Stuffs

Interior walls and surfaces of interior ceilings (i.e. another floor above) are also likely to be manufactured, fabricated, or constructed with materials that can provide an acceptable surface. Logical interior wall options are:

- Modular half meter sections with steel frames covered with steel panels: finished through a controlled rusting process to introduce relief from gray monochromes, or of stainless steel. They can be variously textured or embossed
- Custom built on site using steel studs and Duroc™ panels (a familiar item: half-inch thick fiber-glass-faced concrete sandwiches): the Duroc surface can be accepted as honest direct decor, possibly whitewashed, or stain-washed. Trimwork and/or wainscoting can be of ceramic tile.
- Glass block walls – transparent, translucent, or opaque; of clear glass, frosted or sandblasted, or crude formula lunar glass of gray-black tones.
- Steel framing “upholstered” with stretched fiberglass fabric cover foil-faced fiberglass batting Interior walls too, even though made of harder materials than we are accustomed to using on Earth, can be pre-fitted with purchase points for hanging wall art and shelving. Consider this: We wrote about wall options in MMM #76, June ‘94, p. 4. “Inside Mare Manor: Interior Walls.”

### Exposed Ductwork

Another commonplace in urban Lofts are exposed ductwork for heating and air-conditioning. Using Systems to Decorate has become a flagship feature of the “industrial” style for many public buildings in the past two decades. Ductwork can be designed to have a simple comeliness of its own, adding interest, not ugliness. The original motivator, of course, is the substantial cost savings of not having to “hide” such systems with false ceilings.

The same is often true of conduit carrying electricity throughout the loft or building. With a little forethought, the design of conduit and other “working” electrical and plumbing elements can be enhanced for eye appeal without compromising utility, and at nominal extra cost. Routing such systems offers another opportunity for input from the interior space designer. Slight changes of placement or routing cost little. All one needs to do is pay attention to the decor effects of various options – an attention that is not ordinarily given, but can be.



### Light Pipes

On the Moon, where we have a chance to start fresh on many fronts, one significant opportunity to do things differently is lighting. Light pipe technology has been advancing steadily. Light pipes are passive systems that deliver light efficiently from concentrated sources (solar concentrators, sulfur lamps, etc.) throughout interior spaces, in both straight runs and around corners, to places where the light is needed. Light ports in the pipe/duct system can then be decoratively enhanced by the choice of diffuser or lampshade analog. They can also be shuttered to “turn off the light.” We reported on light pipes in MMM #66 p.7 June ‘93, “Let There

Be Light: light delivery systems for lunar settlements need to be rethought”, and on Sulfur Bulb technology in MMM #36 JUN 2000 p 3. “Nightspan Lighting: Sulfur Lamps & Light Pipes.”

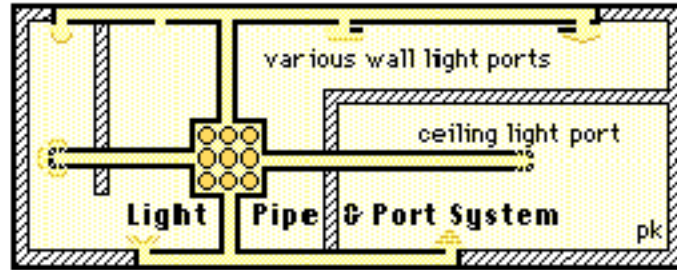

### Flooring

Pressure Hulls have to have curved surfaces to avoid stress points along surface “intersections” that would be prone to fracture, and hence pressure loss. Thus for most hull designs, flat flooring has to be added later. So we will not discuss that here except to mention some of the obvious choices: cast basalt tiles, ceramic tile, glass-composite sheets, concrete pavers, and embossed steel sheeting.

### A Frontier Primary Color Palette

The reliance on “direct decor” – letting the honest character of construction materials provide the setting for added furniture, furnishings, and accessories will result in a naturally lunar, frontier palette of hues, shades, and tones to be played to in monochrome, complementary, or opposite suites. Concrete gray tones can be easily “tinted” by washing them with colored light (bulbs, diffusers, etc.). Eventually, as locally produced sodium silicate and metal oxide pigment powders are produced, applied color “washes” may become an option. Lime or titanium dioxide “whitewash” will surely be the first of these to appear and become popular, on walls and ceilings alike. Metal oxide pigment stains might be used to give highlights to the texture relief.

Tile “trimwork” can accent the concrete, with glaze colors that play to or enhance the natural lunar grays. Steel and aluminum silvers, rust-cured steels or rust-cured steel trimwork can also add accent. Enamels for steels may not come soon. Natural raw frontier glass will be of variegated moon tones ranging from blacker to lighter. If regolith is routinely sifted for glass spherules which are then automatically sorted for color, crude glass with orange and green tones should soon be available. Mirrors hung on moon tone walls can also capture and “import” the brighter colors of added furnishings. Lamp shades, ceramic glazed items, art glass, and, of course, abundant foliage and flowers can add all the “pop and punch” colors one could want. The “industrial” “loft-like” host decor of lunar frontier habitat modules need not be drab. The great creativity and amazing variety of ways in which our urban loft dwellers make spaces with industrial histories very homelike gives us not only insight into the future of lunar frontier homes, but confidence.

**It’s a wrap!** – of course, those who can afford it will find it chic, appropriately pretentious, to bury the construction-processed surfaces with faux facade treatments of one sort or another. But our purpose here is to show what an “everyman’s frontier decor” might be like. <MMM/>

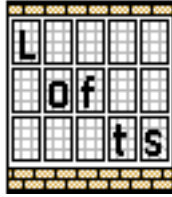

## Urban Lofts & Settlement Style

URBAN LOFTS & SETTLEMENT STYLE By Peter Kokh

### Part II: More Clues from Loft-Living Styles

In the MMM #136, JUN '01 issue, we tried to sketch out what the “feel” of lunar settlement interiors might be like, taking pages from the urban frontier’s “Loft” decorating trends.

Loft styles have been called “industrial” and that is fitting considering the origin of loft spaces – former factories and warehouses. But that origin is really incidental and does not get at the essence of the style, which I would prefer to call “direct decor” -- accepting the surfaces of construction materials (e.g. brick, concrete, steel, ductwork, etc.) as they are, not as a substrate for adding layered faux (false) surfaces such as plaster or drywall (sheet rock in some parts of the country) or paneling for walls and ceilings.

In a Lunar, or Martian, frontier setting, use of “direct decor” would allow faster occupancy, and showcase native materials instead of let’s-pretend-we’re-still-on-Earth “secondary” surfacing. Thus in addition to having modular habitats ready to occupy much faster, this type of transplanted loft style will go a long way to create unique and genuine Lunar and Martian home decors. But we have not exhausted the list of “Lofty Ideas” worth transplanting.

#### Open Floor Plans for Common Spaces

In the prior article, we suggested a number of ways interior walls could be built to be direct-decor friendly. At the same time, it would be beneficial to pioneers eager to occupy their homesteads quickly, if the amount of interior wall structures needing to be built was kept to a minimum. Of course, such walls could always be added -- and moved -- later as desired with evolving life styles and family needs.

Urban Lofts commonly preserve as much of the “wide open spaces” feeling of their host shell as possible. Interior walls, often not extended up to the ceiling, are provided only where privacy is needed, and then commonly only to interrupt sight lines rather than to provide complete enclosure -- for bathrooms and bedrooms.

To be sure, “great rooms,” “keeping rooms,” and other open floor plans for “commons” areas of the home are also growing in popularity in conventional new home construction and also in older home remodeling. The open plan fits today’s life styles.

Yet many “compartmentalized” older homes, such as my own, have floor plans that resist being “opened up.” They serve well enough, however.

On the lunar and Martian frontiers, homestead construction is likely to consist of various assemblies of pre-manufactured modules. In MMM #75, May '94, pp. 4-6 [republished in MMM Classic #10] “Lunar Appropriate Modular Architecture” we showed how a “language” of only a few basic module types would permit quite a variety of “expression.” Use of modules provides spaces that have identities, even if the passage from one to the other is unrestricted. Such an architecture allows interflowing common spaces easy to individually dedicate to special uses: kitchen, dining, family, library, garden atrium, etc. It also minimizes linear footage of privacy walls needed for bedrooms and baths.

Below are some illustrations from that issue altered to show which module seams are open, and which are fitted with walls and doorways. Again, the layout options are endless -- these illustrations are meant to give the reader a general idea only.

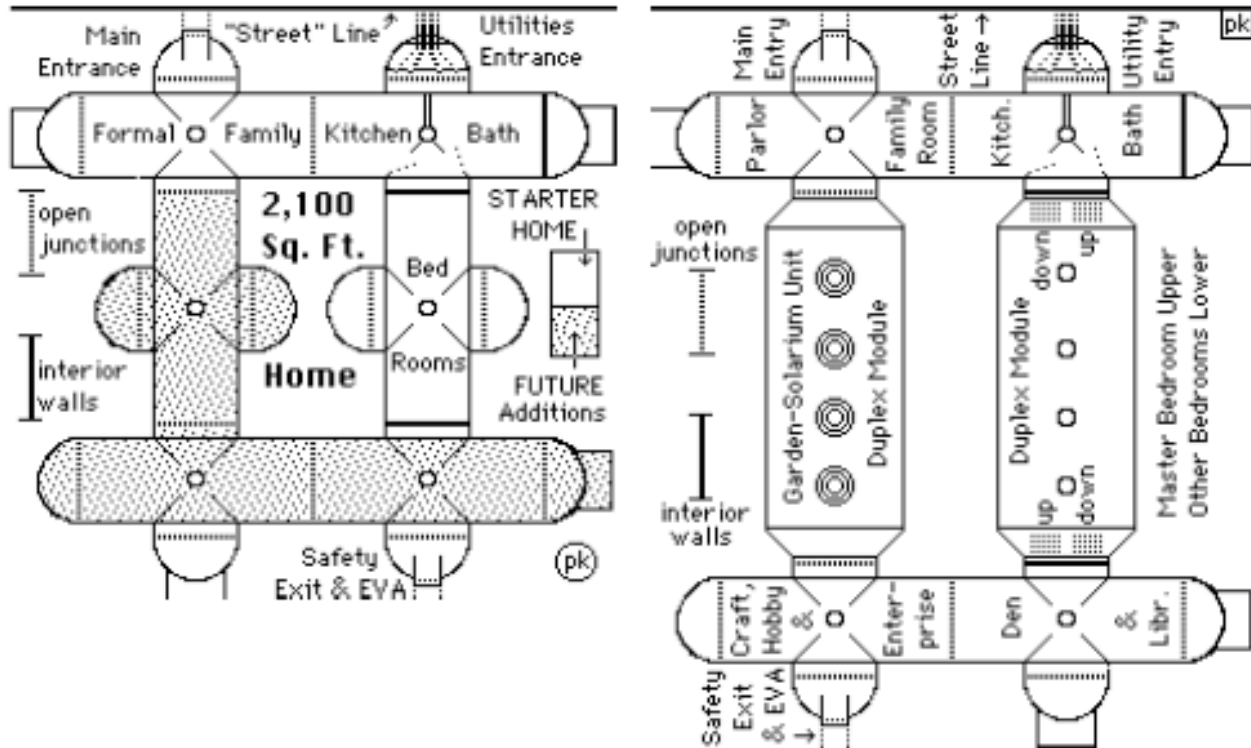

For a more expansive floor plan (of the Lunar Reclamation Society's tabletop Moon Base) see: [http://www.moonsociety.org/chapters/milwaukee/mmm/moonmanor\\_plan.gif](http://www.moonsociety.org/chapters/milwaukee/mmm/moonmanor_plan.gif)  
 Photos of this display are at: [http://www.moonsociety.org/chapters/milwaukee/msmo\\_displays.htm](http://www.moonsociety.org/chapters/milwaukee/msmo_displays.htm)

### Working with the open floor plan

As is clear from the floor plan samples above, the space within each of the interconnected modules is already “distinctive” by its shape, how it meets or intersects with adjoining modules, and possibly by customer-chosen mold-impression texturing. Each of these is a bonus not all terrestrial urban lofts offer. With this built-in distinctiveness, it is easier to give each space its own ambiance and personality.

**1. Distinctive Flooring:** While pioneers can elect not to build interior walls where privacy is not an issue, they cannot elect not to add flooring unless they wish to confine their walking to a narrow strip along the bottom. This is so because pressurized modules in the full or near vacuum environments of the Moon and Mars must be either spherical, cylindrical, or toroidal to avoid critical level stresses on their structures from interior air pressure. Thus they “come with” curved bottoms. We must add flat flooring. A framing platform of metal alloy or glass composite members must be installed, in which can be set tiles, slabs, or other types of floor panels.

The choice of metal alloy panels restricts the amount of decorative freedom somewhat. Different surface textures can be used, along with contrasting color (i.e. a different metal alloy) “inlay” borders or stripes might be possible.

We wrote about using cast basalt tiles, especially wear and abrasion-resistant, for flooring in MMM #135 MAY '00, p. 7-9 “Cast Basalt: industry perfect for a startup outpost.”



Cast basalt tiles are self-glazed -- there is no opportunity to “add” color by glazing. However, there may be room to vary the shading of gray-tones by choice of basalt feed stocks.

That color range will be very subtle at best. Perhaps the best option here is to impose distinctive surface textures by varying the mold shapes. One could also vary the size and shape of cast basalt tiles and create patterns in that way.

Once we start producing metal oxides for use in producing better alloys, we will be able to use many of those same oxides as colorants for stained glass and ceramic glazes. That will open a wide range of decorative possibilities.

Panels made of glass composites can be made in various “moontones” by varying the mix from which the matrix glass is formed. Once we are able to cast clear or transparent matrix glass, then we could add color by using metal oxide powders to dope the glass batches used for making the glass fibers that give the composite its strength. Then we might also play around with combing or otherwise arranging the glass fibers in the matrix to give distinctive “grain” or other patterns to the composite. Nothing like this has yet been tried as glass composite research has been stuck in the lab, totally ignoring a potentially tremendous Earthside market for products like boat hulls, architectural elements, and high end case goods furniture items (where appearance, not price, is important.) We wrote about that line of terrestrial R&D in MMM #16, JUN '88 “Glass Glass Composites.”

**2. Arrangement of Furniture & Furnishings:** even if we pass on the opportunity to create extra distinctiveness of continuous areas by playing with flooring options, we can easily create distinctive “room settings” by simply clustering furniture and furnishings into cozy groupings. Creating a focal point for each setting will help. We are used to doing this here on Earth. Focal points can be a picture window, a fireplace, a catch-your-eye painting or sculpture, or a beautiful area rug. In time, Lunan pioneers will create enough home grown options to do likewise. If there is a generous “heirloom allowance,” allowing each settler to bring along one personally special item from Earth within certain reasonable weight and volume restrictions, then a painting, a rug, or as piece of sculpture from “Old Earth” could be used for such “focal points.”

**3. Using Accent Colors:** On Earth, many homemakers in recent decades have chosen to go with neutral or monochrome color schemes. Some even go so far as to profess a certain “superiority” for such choices. That is a very euphemistic way of diverting attention from their fear of being able to handle color in a non-gaudy way. We humans see in a full range of colors, and enjoy them. Not to play to that pleasure within our homes is a personal self-inhibiting choice but hardly a mark of higher culture.

On the Moon and Mars, where the exterior landscapes are so extremely monochromatic to begin with, almost everyone will feel the need to use abundant colors indoors, especially those not to be found out on the surface. Pioneers will cultivate their green thumbs to an extent unusual on Earth.

With no life at all outdoors, abundant green foliage and flowers will be welcome and pursued with dedication. Other coloration options will come slowly as we learn to extract specific elements and element combinations from the regolith. On the Moon, true white (calcium oxide = lime, aluminum oxide, titanium dioxide) and true black (ferrous oxide, manganese dioxide) will help “bookend” the gray-tones with classic emphasis.

Among the first real “colors” will be ferric iron oxide or “rust”. Sulfur provides a pale yellow, chromium oxide a green. The holy grail will be the isolation of cobalt: cobaltous aluminate produces the brilliant “cobalt blue.” These oxides can be mixed to produce in between colors and shades. There seems to be no lunar-sourceable inorganic source of either brilliant yellow or true red. We’ll have to satisfy our appetite for these colors with flowers, and maybe birds. See also MMM #63 MAR '93, pp. 10–11 “Color the Moon anything but Gray.”

Once such colorants are available, they can be worked into the decor scheme as stained or art glass (including lamp shades or light diffusers), fiberglass fabrics, ceramic objects, “regolith impressionism” paintings, and other ways. Giving each “room setting” a different accent color or suite of accent colors will help create special areas.

**4. Dividers:** on Earth we frequently resort to “room dividers” to subdivide large rooms or create special settings in great rooms and lofts. Dividers can be made of anything, and be either freestanding or suspended from the ceiling. One attractive option for use on the Moon especially is suspended carpets. Carpets, and fabrics in general, are very useful for acoustic sound deadening. The problem on the Moon is twofold: first it would be prohibitive to produce carpets (or other fabrics other than for clothing or towels) from the usual organic or synthetic organic fibers. That pretty much leaves us with glass fibers. We have been producing fiberglass draperies for years and they work well for one reason: very little wear and tear. We do not walk on them or sit on them. Fiberglass is not very wear resistant. Happily, on the Moon with its light gravity, the natural cushioning of our feet and buttocks may be enough. We can still make fiberglass carpets, possibly of unlimited color and design options, if we put them on walls or if we suspend them from ceilings. Carpet dividers will be a – great way to subdivide inter-module common spaces.

**5. Accent & Mood Lighting:** Another way to create “room-like” settings in larger open spaces is with controlled, discriminate lighting. In the past, one often had only one choice: ceiling light fixture or table/floor lamp -- each at one set level. The introduction of three-way lamp bulbs, then of dimmers created many more options. Today with all new light bulbs (especially, halogens and folded fluorescents) and new recessed lighting options, the possibilities for controlled accent and mood lighting are endless.

It is too early to say which light bulb types are best suited for local manufacture on the Moon. One option is to keep light sources, and the heat they produce, on the surface and use fiber optics and light pipes to deliver light where needed in homestead interiors. Movable shutters can throttle the amount of light delivered to any one spot. Working in special diffusers will multiply the special lighting effects available. Shades can be made of glass, ceramic, and punctured sheet metal. Light diffusers of stained glass can lend color to the whole surrounding area.

Take two identical pioneer homesteads: same floor plan, same furniture, same furnishings. Give one only full-on high level general lighting. Install full control lighting in the other so that one room can be fully lit, another have just task light by an easy chair for reading, other areas just enough light to find one’s way without stumbling. In the first, the colors are fixed. In the second, you can alter the colors to suit your mode just by switching colored diffusers. Obviously if it is a comfortable home that we want (and we need to prevent gross defections back to Earth,) providing a full range of lighting options is important, not just to defining interior spaces but to the level of comfort and satisfaction.

### **Open Shelving**

Another choice one sees in some Lofts -- it is by no means common, however -- is to scratch the high expense of wall cabinets for kitchens and other areas by using open shelving systems, which can be built in a number of ways. Doing so involves a deliberate choice to let the shelf contents provide decoration. In kitchens this is relatively easy if one has tableware and utensils worth showcasing. One can choose to do this elsewhere as well, in bedrooms and bathrooms for example. Here, if decoration is a goal as well as simple storage, one can either sort items by color (sweaters, towels, blankets, etc.) or arrange sundry items into pleasing “vignettes.”

In MMM #76 JUN ‘94 p.8 “On the Wall” we described ways in which the curved walls of habitat modules could be designed to make shelving easy. On the horizontally concave outer walls of cylinder modules, only the central portion is suitable to hold things flat so that both top & bottom of the object ‘touch’ the wall.



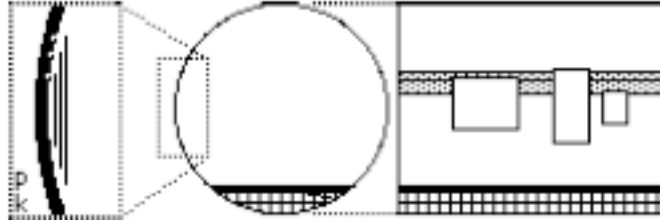

A series of built in hanging strip grooves is a solution that may work, and even presents decorative possibilities, i.e. as broad horizontal striping. Objects can be hung anywhere along the length of the wall, utilizing the hanging groove that best suits their individual height. While the result may be that pictures and other objects are hung slightly below the customary “eye-level”, the hanging groove stripe, perhaps differentiated by texture and/or color from the rest of the wall, will be at the top of this range, serving as a visual corrective of sorts. Shelving is cheaper and easier to provide than furniture-quality cabinetry. So this is yet another “Lofty Idea” with appeal to frontier pioneers. <MMM>

## MMM #149 – December 2001

### In Focus: Distributing Risk - Lessons from September 11, 2001

“Those who do not learn from history are condemned to repeat it.” One of the things that jumps out from the kamikaze airliner attacks of September 11th, is the very different results between the two targets: total destruction of the World Trade Center towers, relatively minor damage to the Pentagon. Yet both facilities were of a similar order of magnitude in total square footage and occupancy numbers.

The towers were essentially **vertical structures where a local failure at any height inexorably doomed the entire structure**. Gravity acted on cue to cascade the initial local damage throughout. Here **the “Failure Mode” risk was shared**.

Additionally, in each tower there was only one escape route, and when that route was severed by the invading aircraft, those above that point were doomed. The Pentagon is essentially a horizontal structure where gravity worked to collapse only the local sections damaged. In this case the Failure Mode risks were distributed. Additionally, the Pentagon is essentially a loop-type structure, with **escape routes in either direction** (clockwise, counterclockwise).

The use of large airliners loaded with both people and fuel as piloted missiles was something unexpected by the architects in either case. Yet even so, air accidents have always been at least a remote possibility. Too remote to design for, perhaps.

On the Moon or Mars, where there may be no one to pick up the pieces or come to the rescue of possible survivors, and where impacts from the sky cannot be ruled out even though the odds are low, **it would be insane to design a settlement megastructure with a shared failure mode: failure anywhere dooms everyone**. The popular artist-inspired vision of lunar and Martian cities under glass domes are an example of fate-tempting architectural bravado. Puncture the glass “firmament” anywhere and poof!

On the other hand, settlements built of interconnected modular elements, would, if connections could be sealed, distribute the risks. Some, perhaps most, would survive all but the most unlikely strike. This is not to say that we won’t see any domes at all. Domes anchored to bedrock in order to resist the outward push of air pressure could someday appear over parks and city “squares.” Such domes would be quite local, and surrounding sections could be sealed off if the dome’s integrity were compromised.

Given that it makes sense to go modular in the first place because that is a method of construction that suits growth patterns, a modular settlement may select from any number of overall plans.

A linear plan of expansion along a spinal transportation corridor might be highly efficient. But given the lessons from the Pentagon event, such a plan risks cutting the settlement into two mutually isolated sections if there were a breach anywhere. But any “urban plan” which provided multiple inter-connectivity between various sections, a loop being the simplest of these, would preserve the continuum of the settlement, no matter where compromised.

Building architectures are not alone in their vulnerability. In human chain of command / information structures, strictly vertical chains risk collapse if there is a failure at any level. Communist party “cell” architecture, with its multiple connections, is an early 20th Century parable worth learning from.

### **Decentralization and Polycentric Infrastructure**

On the Moon and Mars, the integrity we need to protect includes the pressurization “hull-plex” and also the utility systems: fresh and waste water lines, fresh and stale air ducts, electrical power and communications. Again multiple connections will serve us well whereas an efficient and cheaper linear settlement plan would magnify any catastrophe.

In MMM #53 March 1992 pp. 4-6 “Xities and XITY PLANS: settlement layout options” [“xity” being our word for any settlement that has to provide and maintain its own biosphere], we suggested that it might work much better to design neighborhood scale utility systems. Instead of one central plant for each utility system, we would simply build additional plants as we added additional neighborhoods. Our intent was to accommodate variable growth patterns and, not to commit the settlement to soon outmoded systems. If the settlement’s utility structure was also modular, newer areas could have the benefit of improved systems when available. MMM

## MMM #152 - February 2002

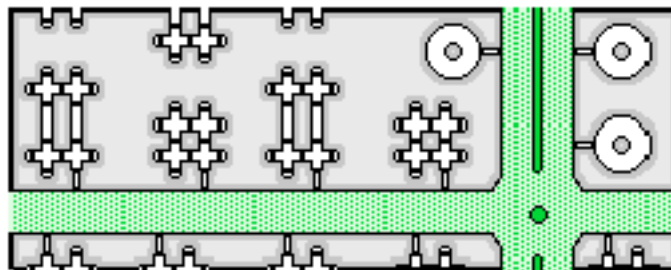

### **The “Middoors” as key Biosphere Component**

In a modular settlement, allowed to grow as need be (not a fixed size megastructure based on someone’s guesstimate of future needs), modular habitats and other structures are connected to pressurized residential/commercial “streets.” These “commons” will contain the bulk of the settlement’s biomass and biosphere. See “Being able to go Outside” below.

## **Homes “at home” on the Moon : Thermally Self-Regulating Lunar Habitats With Backup Off-Grid Power Systems**

By Peter Kokh

Impossible? We will feel more “at home” on the Moon if our homesteads are designed to play the lunar thermal cycles so as not to depend totally on any outside heating or cooling inputs. A power grid may be essential, but power grids fail. On Earth this is a matter of inconvenience: bundling up if it’s cold, meat spoilage if it’s hot. On the Moon a temporary power plant outage could be a death sentence for many, if not all, if there are no back up systems. And building a modular back-up capacity into each unit will certainly provide the best security of all.

We are talking about thermal equilibrium as well as electric power generating capacity. This goal is not something new. There are a small but growing number of homes in this country whose architecture and construction materials attempt to achieve an analogous “environmentally tuned” balance, first as to thermal management, second with respect to off-grid power generation capacity. On the Moon, this may well be a goal that will not be achieved without a an even greater amount of trial and error experimentation. The time to begin brainstorming is now, however, as our security and survivability will be tenuous and fragile from the gitgo -- until we can start building in this fashion as a matter of habit. The reward will not only be safer settlements but the feasibility of small isolated rural outposts wherever they are needed -- and they will be needed!

### Thermal Storage Systems

Paper studies of possible thermal storage systems can help to get a first read on the merits of competing approaches, the comparative difficulty of installation and the engineering and technical challenges of each. On Earth, architects and builders have come up with a variety of passive and active systems. Some of these may suggest analogous solutions that will prove workable on the Moon. Other solutions will prove to be uniquely terrestrial. But we should not limit our brainstorming to the exploration of the adaptability of schemes we have tried here. It would be rather surprising if we did not find some uniquely lunar solutions. But to prime the reader’s imagination, here are some of the more common thermal management techniques tried on Earth:

- super-insulation to keep out both excess cold and excess heat. On the Moon, that may not be enough, even if the stress of more extreme dayspan heat and nightspan cold is met. Daily living activities may produce a net heat excess that must be radiated to space to prevent steady heat buildup. Super-insulation with radiators are one approach

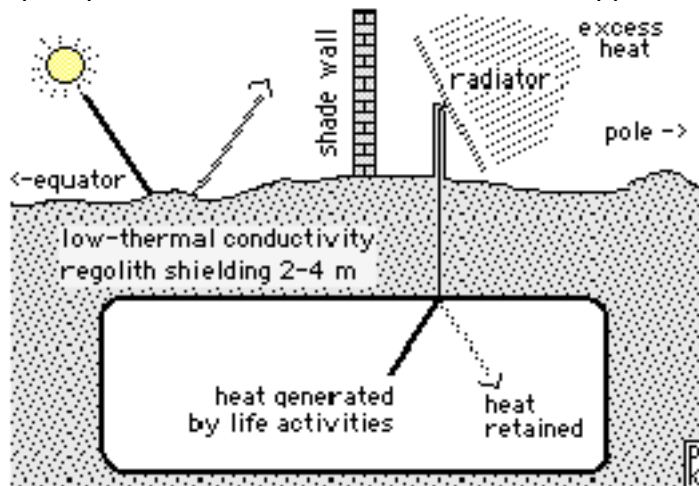

ABOVE: regolith shielding acts both to keep solar heat out of the habitat, and to keep heat generated by life activities within, Excess heat buildup is handled by shaded radiators shedding heat to the black cold sky.

- **passive solar** – allowing some solar heat to enter during the dayspan through periscopic windows and sun pipes that filter out most infrared wavelengths. This heat could be stored

in massive reservoirs (cast basalt floor tiles, concrete hull, massive interior walls, water reservoirs etc.) for use during nightspan. A radiator system would still be needed to handle any net excess.

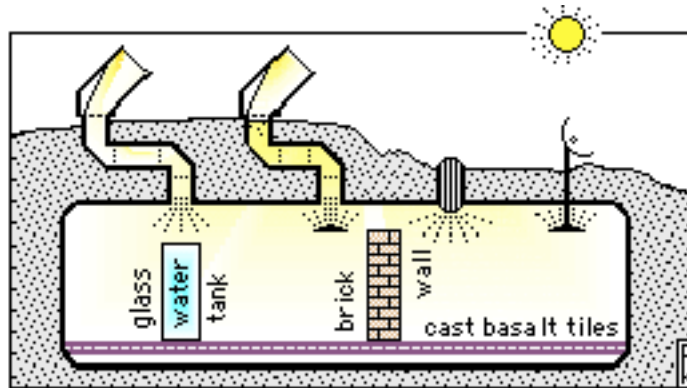

**SHOWN:** Controlled Passive Solar Inputs (heliostats and sun pipes with two types of light diffusers) and Thermal Storage Systems to radiate stored excess heat back into the habitat space in nightspan (massive floors, massive walls, and water reservoirs).

- **active systems** using water reservoirs to store cold as ice. Water is an ideal heat storage medium in itself, the more so because we will need to have an ample amount of it for biospheric stability. A water reservoir, connected to the homestead but exterior to it and insulated from the sun by two meters of more of soil, may be part of the solution. To shed excess heat, radiators may be needed. Want more of a challenge? Integrate semi-autonomous point source pretreatment of waste waters.

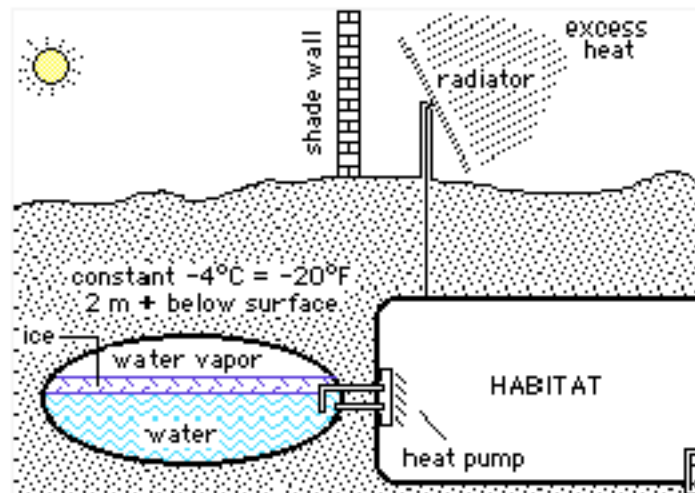

- **active systems:** magma-based. If nightspan heating proves to be a greater problem than heat build-up, one system that could provide nightspan heat and power too, would use excess solar power capacity to melt regolith during dayspan, store it in a refractive alumina-lined cavity underground, and tap its heat (steam-powered generator) during nightspan. David Dunlop came up with this idea, and it may be more realistic for a neighborhood-scale habitat-cluster implementation.

### Translating systems that work on Earth to something that will work on the Moon

We have but a layman's knowledge of thermal management engineering issues. Our purpose is to encourage those with the expertise and terrestrial thermal management experience to brainstorm how we might engineer stand-alone self-regulating lunar habitat spaces attune to the lunar dayspan/nightspan rhythm that will function autonomously and worry free off-grid, should there be a power interruption. Not all of the great variety of schemes

that have been tried on Earth with some success will successfully translate to unique lunar situations. But they are a starting point for brainstorming and we offer these ideas not to close discussion and experimentation but rather to begin it.

### **Electric Power Generation: Cluster or Neighborhood Solutions:**

In search of safety and security, we should look not only at individual pressurized structures but at the structure of the utility grids themselves. Centralization concentrates risk. A decentralized “cellular” grid structure with a “neighborhood by neighborhood” approach has advantages. By decentralizing power generation, building modular power generation plants so that each serves a cluster of pressurized structures or neighborhood, we provide a great deal of redundancy and resiliency. The fruit will be greatly increased “at home” peace of mind.

Whatever tricks we can master to maintain thermal equilibrium ought to include power generation survival systems that can operate off-grid for an appreciable amount of time, if not indefinitely. There are plenty of risks to pioneering the Moon. We need to minimize them, not increase them by over-dependence on centralized utilities that should be used to go beyond the minimum, not to provide it.

### **Off-Grid Electric Power Generation**

If and when architects and structural systems engineers come up with plans that works to minimize the need for grid power to maintain a livable interior temperature range, we'll still need to address the question of providing autonomous off grid power systems for lunar homesteads for back-up insurance and safety for other electric uses besides heating and cooling -- communications, refrigeration, food preparation, etc. Every pioneer home should be able to operate as if it were a small isolated rural outpost.

Each habitat or pressurized space should have solar power panels of some type. These could be sized to provide a more than minimum power needed during dayspan -- enough extra to electrolyze waste water (thus recycling it at the same time) to run fuel cells for nighttime power and fresh water. This equipment should be a standard part of any habitat electrical system and a requisite for grid hookup.

### **Minimizing the problem: Dayspan and Nightspan in the home**

Even while the settlement power plants and grid are operating normally, pioneers may get in the habit of living at a different pace in the alternating two week long stretches of abundant sunshine and unbroken night. Even with a nuclear power plant, there will still be more energy available in dayspan when solar panels and concentrators are also at work.

Production operations will concentrate on power-intensive tasks during dayspan, leaving manpower-intensive tasks for night, when and where feasible. Within their homes, on their own time, it will make sense for Lunans to organize their household chores in like fashion, again where feasible. These go-with-the-flow practices and habits will provide extra resiliency in case of a grid power emergency, putting less strain on domestic backup systems.

The Reward -- In preparation and resiliency lies security, and a sense of being “at home”.

### **Reading from MMM Back Issues**

#7 JUL '87, “POWERCO”

#43 MAR '91, pp. 5-6 “SUNTH Dayspan, Nightspan”

<MMM>

## **Being “at Home” is Completed by Being able to go “Outside” The Concept of the “Middoors”**

[A synopsis from past MMM articles. See list at end.]

By Peter Kokh

No matter how cozy the home, if you are a virtual prisoner inside, your sense of being “at home” will be most uncomfortably limited. But “outside” on the Moon means out on the vacuum-soaked, radiation-washed surface -- or does it?



Thanks to the appearance in recent decades of enclosed climate-controlled shopping malls, the idea of something in-between the indoors and outdoors (a distinction as old as man) is now familiar to most of us. The “midoors” [i.e. between the doors of homes, offices, shops and the doors to the

natural outdoors] is also prefigured in the landscaped, sunlit atriums in new hotels, office buildings and even cruise ships. The beachhead science outpost will be simply a pressurized indoors up against the outlocks vacuum, the “outvac”.

Whether in a government outpost or in an early company mining town, the construction of the first spacious atrium solarium garden will introduce a new kind of space – a space external to individual quarters, lab modules, and other work and function-dedicated pressurized places, yet still keeping out the life-quenching vacuum beyond the airlocks and the docking ports. What we have called the “midoors” will be born.

From this humble beginning, airy, spacious, verdant middoor spaces will grow to eventually host the greater part of the settlement’s atmosphere and biomass. And with it, the hoped for “biospheric flywheel” will become much more of a reality.

It is within such spaces that longer, wider sight lines will appear, offering postcard views and vistas, to dull the edge of early day claustrophobia. The settlement will begin to take on the trappings of a little “world”, a continuum of varying horizons. The effects on settler morale will be considerable.

In Lunar cities, except to enter and exit those industrial facilities which for safety's sake must keep their air unmixed with that of the city at large, it will be possible to go most anywhere without donning a space suit. Homes, schools, offices, farms, factories, and stores will exit, not to the airless, radiation-swept surface, but to a pressurized, soil-shielded, indirectly sunlit grid of residential and commercial streets, avenues, and parkways; parks, squares, and playgrounds; and pedestrian walkways.

While the temperature of “indoor” spaces could easily be maintained at “room comfort” levels, that of the interconnecting middoors of the city could be allowed, through proper design, to register enough solar gain during the course of the long Lunar dayspan and enough radiative loss during the long nightspan to fluctuate 15 °F on either side, for example from 55–85 °F during the course of the lunar sunth.

Midoor spaces could be landscaped with plants thriving on this predictable variation. This would be invigorating and healthy for people, plants, and animals alike, providing a psychologically beneficiate monthly rhythm of tempered mini-seasons. Of course, the middoors could be designed to keep a steady temperature. Oh how boring that would be!

For perhaps the greater part of the population, the creation of generously-sized pressurized commons, nature and picnic parks and playing fields and parkways will satisfy everyday needs for the “outdoors.” Sheltered from the cosmic elements, such spaces may nonetheless have an airy, supportively verdant feel to them. Such public common spaces form a matrix within which the indoor spaces of homes, offices, shops, schools, and factories can literally “breathe”.

The more generous and more high-ceilinged spaces of the Lunan middoors can be realized by several architectural devices. Pressurized cylinders carrying vehicular traffic can have a radius generous enough to support green strips with hanging gardens, trees, walking



and jogging paths, even meandering trout and canoe streams. Spherical or ovoid or torus structures can serve as more self-compact nonlinear park and nature space. Farming and food production areas can host public footpaths and picnic oases.

Sunshine ingress can be provided by bent path heliostat “sundows”, by optic fiber shielded “sunwells”, or more radically, as Marshall Savage suggests, by water-jacketed double domes. These are designed not to allow views of the outside, but solely to flood the interior with soft water-blues sunlight.

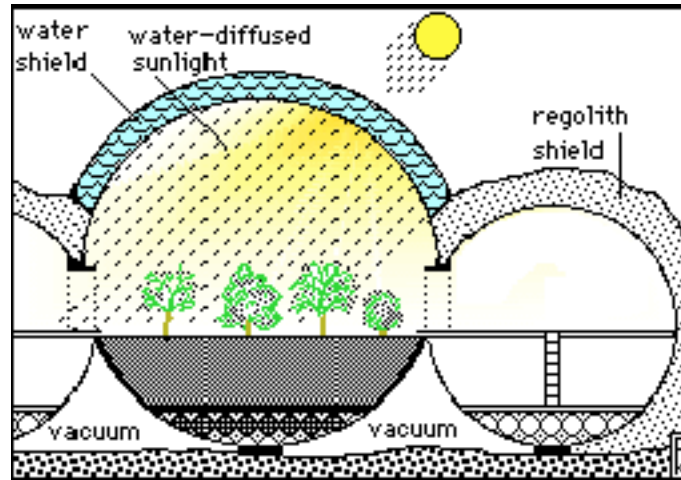

Well-designed middoor spaces in a generous acre per citizen ratio can probably substitute for the open-air greenspaces of Earth for a large cross-section of the settlers. Others will need to come to personal terms with the out-vac. Still others will never be able to leave behind the green hills, the ocher deserts, the blue skies, the thick forests, the horizon to horizon expanses of ocean deep of the home world. We will be able to walk, hike, bike, skate, row and trout-fish in lunar middoor spaces. Cherished outdoor activities that are more challenging to replicate but seem eventually doable include skiing and tobogganing in pressurized tubes positioned on the slopes of craters (see “Skiing the Moon” MMM #115 MAY ‘98).

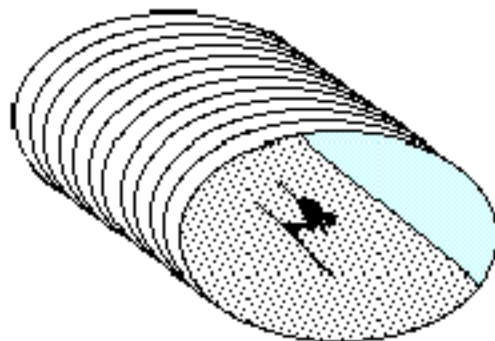

Also doable is manned flight. Out of the question, at least in the early days of settlement are activities like powered flight and soaring, skydiving, motor-boating, sailing, ocean cruising and hunting for example. We’ll be able to go caving or spelunking in lavatubes, but in pressure suits. Each person pondering signing up for the lunar frontier must weigh his or her attachments to cherished activities that may not be supported in lunar settlement biospheres any time soon, if ever at all. Those taking the plunge will owe it to themselves to be politically and civically active in guaranteeing that the settlement middoors is as generous and diverse and user-friendly as economically possible. Nothing less than the morale and mental health and long-term survivability of the settlement is at stake.



While tightly climate controlled “indoor” spaces may vary but slightly from comfortable “room temperature” and humidity levels, the middoors may be designed to swing freely from a late pre-sunset dayspan temperature that is tolerably warm and humid, to a late predawn nightspan temperature just enough above freezing not to harm the various plant-forms within. “Sunthly” “weather” patterns will add welcome variety and spice to day-in, day-out life.

That favorite conversation-making unpredictability of terrestrial weather, however, may be hard to program in. If temperate food plants are desired, perhaps an annual hard frost might be arranged one nightspan a year, as part of a partial cleansing freeze out of accumulating atmospheric pollutants and impurities. It’s a thought. And depending on ceiling heights of the street vaults, any gradual increase of humidity levels beyond a certain point might trigger mist-making condensations, say sometime after local sunset. At any rate, such middoor “weather changes” will help keep the populace healthfully invigorated, as well as supplied something innocuous to complain about. A fringe benefit will be a whole new cottage industry to create fashionable “outerwear.”

PK

## MMM #157 – August 2002

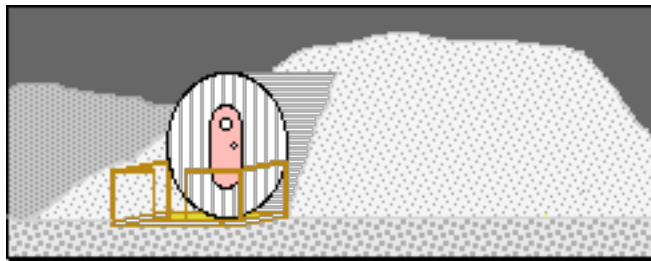

### PORCHES ON THE MOON?

By Peter Kokh

The Inspiration for this essay was a 7-28-02 HGTV Cable TV special “Americans & Their Porches”

Dictionary

**Porch:** 1. an exterior appendage to a residence, forming a covered approach to a doorway. 2. U.S. a verandah.

#### A brief ancient/modern history of porches

The porch or portico is an ancient amenity going back at least two thousand years. Porches became a common feature of homes built in the 19th Century in America, offering a middle ground between the inner sanctum of the home itself and the outside world, specifically the neighborhood beyond. They have served several functions:

- greeting neighbors and passersby without having to invite them inside, thus enjoying the pleasures of civility and neighborliness
- enjoying the weather within reach of shelter; sunrises and sunsets, approaching storms, breezes
- nature watching: sunrises and sunsets, trees and gardens, birds and other wildlife
- storing paraphernalia used outdoors
- shedding dust and mud before entering the home

Porches began to disappear from both new and old construction after World War II. New housing was needed at the lowest no-frills price possible. In old housing, porches were converted to extra indoor rooms (bedrooms, 3-season rooms) for growing families more cheaply than by building an addition from scratch. Television was new and proved to be an addictive lure away from porch-sitting (people in general seemed to become more self-involved.) Air conditioning made indoor relaxation more appealing. Small town USA was not immune to such changes, but seemed to hold on to porches

longer. The pendulum is swinging back. Boredom with the TV/Cable boob tube passive wasteland, a purposeful reemergence of neighborliness, a rediscovery of the pleasures of relaxation and real weather -- all these are luring more people to their own bit of outdoors. There is a growing "new urbanism" that is rediscovering the city (as opposed to the suburbs) and the greater opportunities afforded by higher density and diversity to enjoy the pleasures of more frequent contact with neighbors. "Porches build community."

### Functions of Porch Analogs on the Moon

The essence of a porch is an interface between "home/habitat" and "world." On the Moon. In pioneer settlements, the opportunity to establish such an interface occurs on three levels:

1. outside the airlock (if there is one)
2. outside a door opening onto a pressurized public passage
3. inside adjacent to an indoor "yard" or solarium garden space or "Earthpatch"

### Out-vac "Porches"

Our illustration above may seem whimsical. But an airlock-connected "porch" could be useful:

- provide a place and the means (a special "doormat") to shed troublesome moondust before entering - we talked about ways to do this in MMM #89 OCT '95, pp. 5-6 "Dust Control" (design of a special turtle-back suit and mated airlock)
- a place to store equipment used outside
- if roofed, shade from the glare of the sun
- relief (if the roof-canopy has a sufficient regolith blanket) from micrometeorite rain and cosmic ray exposure while doing routine outdoor chores like changing out fuel tanks - this is the concept of the "Ramada" which we talked about in MMM #37. JUL '90 pp. 3-4 and in MMM # 89, OCT '95 pp. 3-4 "Shelter on the Moon"
- an opportunity if so desired, to customize the out-vac entry to their personal family haven

Here is an illustration of the porch canopy concept from the MMM #89 "Shelter" article:

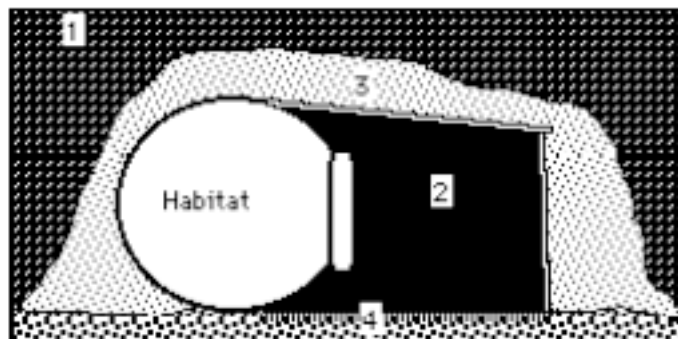

**Illustration above: Directly Shielded Habitat with Carport/Service Area Shed:**

KEY: (1) Exposed Vacuum; (2) Sheltered Vacuum; (3) compacted and sintered floor of carport, part of dust control strategy.

Another way to achieve the same sort of protection is to place habitat structures within or under a shielded hanger-like shed. Another illustration from the same article:

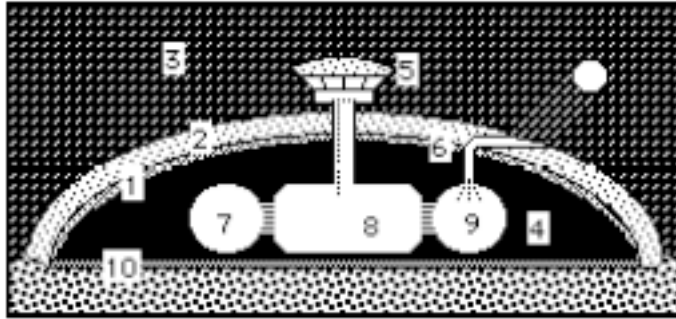

KEY: (1) Space Frame Arch, Fabric Cover; (2) 20 cm or more regolith dust shielding; (3) exposed vacuum, radiation, micro-meteorites, UV, solar flares; (4) protected lee vacuum service area; (5) observation cupola with ladder shaft to habitat space below (7, 8, 9); (6) broken-path solar access via heliostat and fresnel lens diffuser; (10) compacted, sintered hangar apron

Ways to customize one's out-vac surface entrance (color, texture, and design options) were discussed in MMM #55 MAY '92, p 7, "Moon Roofs." [reprinted in MMMC #6]

### Middoor Porches

The concept of the "middoors" is simple. In lunar settlements, there will be pressurized climate-controlled shielded spaces "outside" individual habitats and work structures but "inside" as opposed to the vacuum and radiation washed exterior surface "out-vac."

Recently, we wrote about the role of these middoor spaces in supporting a large portion of the settlement biosphere: MMM #152 FEB '02, pp. 5-6. In this concept of the modular settlement, growing naturally a module at a time, each residence unit has an airlockable entrance on to a pressurized residential thoroughfare.

The street frontage serves as the interface through which individual-private and shared-public worlds meet. Thus that entrance façade will probably be a more popular canvas for a distinctive statement. "I'm unique and proud of it." Here is an illustration of some possibilities from MMM # 109, OCT '97 pp. 3-11 "Luna City Streets." [reprinted in MMMC #11]



### Sidewall section of a residential street, suggesting how homedwellers might customize entrance façades.

Now these "middoor" entrances provide an architectural opportunity to do more – to provide a "porch" enabling setback or easement on the residential street. These can be left empty or unstructured, but may eventually entice home dwellers to use them as semiprivate, semipublic spaces where they can relax and enjoy opportunities to socialize with their neighbors and passersby. Such a "porch" will also allow them to enjoy the less controlled middoor climate -- in the middoors, temperatures might be allowed to swing in natural dayspan-nightspace (29.5 day) cycles as well as seasonal cycles fitting for the kinds of plants (and wildlife) desired. It will also provide "at home" relaxation space from which to enjoy any settlement "urban wildlife": birds, butterflies, squirrels, etc.

The Middoor porch would probably not have a roof or canopy, sharing the protection of the unpressurized street itself. But railings, hanging pots and planters, swings and gliders and other seating and tables might become a common sight.

The pioneers will have other opportunities to socialize and bond, to be sure: at school, at work, and in voluntary group activities. But there is something special about the

unprogrammed unstructured opportunities for “neighborliness” that a “curbside” porch brings. It is an easy place to be, within reach of one’s inner sanctum on a moment’s notice or whim. An “at home” place to enjoy living in a settlement.

It is not enough to build the settlement physically, nor enough to provide an ample and varied modular biosphere. It will be essential, if a human presence on the Moon is to truly endure and not be just another false start leading to history’s most expensive “ghost town” to aim beyond those two goals.

We have to do what it takes to build the settlement as a community . The “midoor porch” may have a strong supporting role to play in this effort.

### Solarium Garden Patios

One of the noted pleasures of porch-sitting, enjoying the surrounding trees, shrubs, and flowers, to be sure does not require street-facing placement. A backyard patio will do as well. On the Moon, homesteads are more likely to “interiorize” any private “yards,” that is, to have garden space or “Earthpatch” atrium solaria in which they can garden away to their hearts’ content. See MMM #148 OCT ‘01 pp. 3-6.

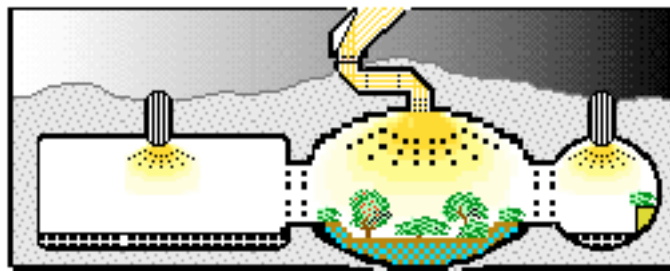

If you have such a pleasant space within your home, full of greenery, flowers, fresh air, fragrances, and sunlight, why not have a place along its perimeter to sit and relax and commune? It is not a matter of choosing to have a curbside porch and an interior atrium patio -- lunar homesteaders can have both. But depending on the architecture, they could have both in one. In other words, put the atrium solarium to the front of the house so it opens onto the street scape as well. The MMM #89 article illustration shows the both options.

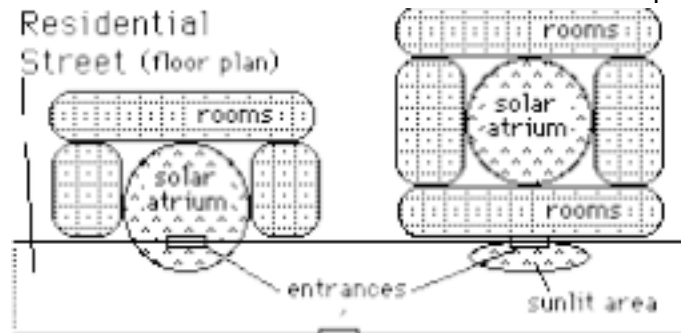

Strange as it sounds at first, the “porch” may become a commonplace of lunar pioneer life. <MMM>

## MMM #160 – November 2002

### Will Settlement Change The Moon’s Appearance?

By Arthur P. Smith and Peter Kokh

Thoughts on a Controversy & Artists to the Rescue

Arthur P. Smith <[apsmith@aps.org](mailto:apsmith@aps.org)> 10-27-02

A couple of thoughts I had:

## 1. Surface Changes and Developments

We've had this slight bit of controversy the last six months or so [in the Moon Society discussion lists] about "development" of the Moon, and how that could spoil it for all the Moon lovers down here on Earth. I think some images showing the potential for transformations of the face of the Moon in future might gain us a lot of good will. The Heinlein cover with split Earth/Moon that Ian [Ian Randal Strock, Editor] ran on Artemis magazine recently is an example of the idea –

### **Would the Moon not be more beautiful if it was endowed with the colors of life, rather than its current grayscale desolation?**

You could start from a full-Moon image as it is now, focus in on, say, Mare Anguis and a Lavatube development, making at first almost no perceptible change in lunar (surface) appearance. What change in fact would it make? The shimmer of solar panels? Radiators hidden from the sun? A variety of mining vehicles, and a landing/launch facility on the surface... Would any trace of the inner life seep through a "skylight"?

Then fast-forward a few decades – the shimmer and skylight effects spread, new structures rise above the surface; a "mass driver" or two are installed for transport of lunar materials elsewhere; lunar solar power stations covered with solar panels and dotted with radio telescope-like transmission antennas appear. But all of these would be close to invisible from Earth – what would such changes in relatively tiny patches of the Moon (less than 1% of area, more on the edges than in the center) look like from that enormous distance?

Development then spreads further – craters are enclosed, some locations become highly desirable, others less so. Clusters of blue-green-brown appear amid the gray. What would our moon look like, with tiny flecks of color, concentrated here, sparser there?

## 2. Subsurface Activities.

At first a lot of what is done will be underground [within lavatubes and/or under mounds of moondust shielding], for radiation protection and thermal stability. How will agriculture and industry mix beneath the surface? Lighting and temperature in an ambient –20 C environment. Lots of mushrooms growing in the dark? Chickens, rabbits, pigs on a farm? Giant sulfur lamps lighting acres of growing wheat and corn? Algae growth pools and drying facilities. Workshops where bulk lunar metal is forged, and united with electronics and light machinery imported from Earth. Sports arenas. Homes that are some cross between a cave and a modern cottage. And some airlocks, barriers, and other safety devices to guard against loss of atmosphere.

There's lots of things an artist could work on, fleshing out the vision we have of lunar development. I'd love to see it happen!

### **Changing the Moon's Appearance: & Reality Checks**

Peter Kokh <[kokhmmm@aol.com](mailto:kokhmmm@aol.com)>

Near term, I doubt that we could do much that was noticeable. If we did widespread harvesting for surface volatiles, that "gardening" operation would tend to raise the albedo a bit for the areas covered, making them brighter.

Surface Night lights from the settlements might be noticeable in telescopes, but a settlement would have to be pretty humongous for its surface lights to be noticeable from Earth. Most of the activities that are supported by outdoor lighting on Earth would take place indoors or middoors on the Moon. Surface roads would be fewer in number than the subsurface ones at least in urban areas. That said, I'm all in favor of a lighthouse beacon on the Moon at the intended settlement site before the first Moonbase module is landed. Green light is supposedly the most visible, and also the least disconcerting. Green signifies "life," "okay," "go."

Most changes would be so gradual, that no one would really notice. In stark contrast, the changes we have wrought on Planet Earth as visible from the Moon over the past century must be startling! The bright light clusters from urban areas and gas field burn offs are

something new in the past century for prospective observers on the Moon. But I think most would see that a beauty, not pollution.

There are concerns, but I think less about mining activities and other physical alterations that might change the appearance of the Moon to lovers on Earth. I worry about something else, something more difficult to fight, something much more insidious.

If our habitats were leaky and there were enough of them, there might be some slow faint rusty gray patches around settlement areas as some of the free iron fines were oxidized by traces of humid air. As more and more volatiles are pumped into the vacuum from rocket exhaust and leaky airlocks and seals, the longer it will take to dissipate into space. In time the extremely tenuous lunar atmosphere would be come progressively less tenuous. There would be more and more rusting, and someday, even occasional dust clouds.

We have written about dock-locks, snuglocks, barometric airlocks, turtle back suits, iron fine burning rockets, and other contraptions that might help conserve air, slow leakage losses, and slow vacuum degradation. The lunar vacuum is a priceless scientific-industrial resource. We shrug our shoulders at its slow contamination to our ultimate irrevocable loss. Inefficiency is always costly in the end. The settlers will have an uphill battle as it is first to achieve economic import-export breakeven, then to steadily be in the green in gross trade with Earth and other solar system markets. They will be highly motivated to "do it right from the start."

<PK>

P.S. In another article we show that most mining will be simple sifting of surface moondust and that the effects of this should be invisible to Earth, even through powerful telescopes.

## MMM #166 – June 2003

### Designing Surface Structures for Moonscapes & Marsscapes

By Peter Kokh

#### Introducing a touchy topic

Not all persons interested in a permanent human presence on the Moon and Mars share the same sensitivities when it comes to design with respect to site context. A bridge is a bridge is a bridge, say some, no matter where you plunk it down. No, say others, any structure should take in mind its visual environment when fine-tuning design details, or even in choosing between major design options.

Living in a 120 year old neighborhood in which a new replacement police station and library have recently been built without any visual allusions to the neighborhood context, as if they were dropped on site by some gigantic helicopter, I tend to side with the latter view. At the same time, to impose a narrow set of allowed styles can be quite suffocating. Variety is the spice of life, and vive la difference!

So where is a reasonable middle ground? In plain fact, if there is to be a free enterprise economy, there will have to be some latitude in design constraints for structures that are visible on the surface of the Moon and Mars.

#### Relevant Readings from Past Issues of MMM

MMM # 55 May 1992 p. 5, "Skyscrapers on the Moon," p. 7, "Moon Roofs"

MMM # 111 December 1997, p 4, "Lunar Skyscrapers: Shattering Low Expectations"

MMM # 137 August 2000, p 5, "Taking-Back-the-Surface Architectures: 'Blend in' or 'Stand Proud?'"

One fight we can expect is between those who will insist that any structures built on the surface of the Moon or Mars – bridges, towers, signage, etc. – be designed to blend into the moonscape or marsscape, so as to appear "to rise out of it" so to speak, and those who believe



that we should be proud of our achievements, and our surface structures should “stand proud” of the host landscapes. There would seem to be legitimacy to both points of view and we can expect to see examples of both come to being.

In the articles cited above, the very use of locally produced building materials, and the need to preserve radiation shielding integrity for all pressurized structures, does per se confer a language of distinctively lunar or Martian forms, shapes, and color schemes. If we build to address the economic need to work with local materials, and the life threats of the host alien environments, this level of “blending in” is almost assured.

In “Moon Roofs” we detailed a number of ways of “dressing up” the regolith shielding mounds that cover our habitat structures: lime or titanium dioxide whitewashes, rust iron oxide, black ilmenite; cast basalt slabs, molded lunar concrete, etc. In the two articles on skyscrapers, we suggested individually shielded “pentroofs” for each floor, pagoda style, if you will. While such high rises would clearly bust the horizon, they would do so with shapes that would be distinctively appropriate for the planetary context.

That, of course, does not address the question of whether or not they should be built at all. But we are sure that they will be, sooner or later. And in our opinion, this will be fine.

They won’t be towers of stainless steel and glass, Mies van der Rohe style, after all!

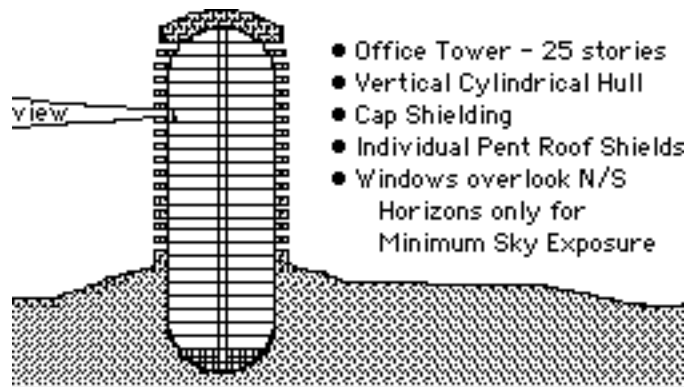

Pentroof Skyscraper on the Moon, from MMM # 55, p 5



Shielded building on Mars' surface, from MMM # 137, p. 6

### **Bridges, communications relay towers, tourist observation towers, utility poles, road signs, and, yes, billboards?**

Clearly, when designing habitable structures on the Moon and Mars, the cited considerations will tend to result in buildings that “belong”, yet “stand proud,” a happy result. But what about other structures: bridges, communications relay towers, tourist observation towers, utility poles, road signs, and, yes, billboards? With no need to pressurize and shield, would not “form follows function” and the “most economic use of available materials” rule? One’s first inclination may be to plunge into this debate adrenalin pumping and ready to fight. Let’s do some background work first.

### **Just the facts: Available Materials**

On the early lunar frontier available metals and alloys will include cast iron, low carbon steels, aluminum, and magnesium. Magnesium may become a favored material of architects and builders, given that in the lunar vacuum, oxidation will not be a problem, and it takes less energy to



produce than aluminum. Stainless Steel would seem unlikely.

Cast iron, the darling of the early industrial age on Earth in Victorian times, could be a staple for lunar architects and perform quite well in low lunar gravity. No protective paint would be needed. Exposed metals would lose their shine over time from micrometeorite bombardment. Designers will be keeping this in mind. Given these facts and considerations, a “language” of out-vac exposed metal use in bridges and towers may emerge that will be characteristically “lunar.”

On Mars, high carbon steels should also be an economic choice, possibly stainless steel as well. Micrometeorite bombardment will be greatly reduced, wind-borne sand and dust abrasion being the greater problem. Here too, oxidation will not be a factor. Steam treated cast iron with rust coating could be used by designers and architects where “blending in” does not compete with a need for high visibility for safety reasons (structures that could become driving/flight hazards if not easily picked out by the eye.)

Sintered regolith and regolith blocks would retain the coloration of host materials on both worlds. Concrete, being based on lime cement, tends to whiten the sand and aggregate also used. Untinted cement would blend in quite well on the Moon, less so on Mars. That would be a safety plus for concrete paved roads on Mars. On the Moon, a row of cleared rocks and breccia along the shoulders, or maybe straight down the median strip, would be enough to clearly mark the route.

Cast basalt will be economically available in many areas of both Moon and Mars and retain the basic coloration of the original materials. Raw (no special formulation) glass or glassified blocks would do likewise. Tinted glass cladding, modern skyscraper style, would seem to be a foolish option, given micrometeorite rain on the Moon and sand abrasion on Mars. Durable cast basalt tiles, slabs, and sheets may be the best choice when “shine & sheen” is a design goal for the structure in question.

### **Economic Choices: the Bottom Line**

On the Moon and Mars, as on Earth, the “bottom line” is something not to be dismissed. Sometimes designers have a “luxury allowance” for visual impact, especially when designing structures intended to become corporate icons, or urban “signature” edifices such as the Sydney Opera House, the Seattle Space Needle, St. Louis Gateway Arch, and the Milwaukee Art Museum’s new Calatrava addition on the Lake Michigan shore. ([www.mam.org/site/photos/images/mam8.jpg](http://www.mam.org/site/photos/images/mam8.jpg))

Such icon and signature structures will appear on the Moon and Mars as well, and I, for one, welcome them. Yet even here, among competing designs, economic choices may force solutions that favor use of materials that tend to blend well with the host environment. Form is a different question, and especially for icon and signature structures, “standing proud” is likely to win any battle with “blending in” when both cannot be achieved together, as ideal.

### **The Mundane and Utilitarian**

We will need road and railroad bridges, pipelines, utility poles, and communications relay towers. Economic motives are likely to be paramount. When will it be cheaper, and safer, to bury utility lines than to erect miles of posts? The solutions to those equations on the Moon and Mars, may not always be the same as they are on Earth. One consideration is Right of Way. Mars and the Moon are wide open, and right of way easements are unlikely to pose a problem or to constrain design choices and options.

When utility lines and pipelines follow highways, it would make sense to design each with the other in mind, if not in combination. Doing so might promise better visual results. When they do not follow roadways or passenger rail lines, but traverse seldom visited terrain, spending the extra buck to make them “blend in” will be unlikely.

Another consideration will be to balance the up front cost of construction alternatives with any lifetime maintenance costs. It has been common on Earth to discount the latter, i.e. for builders to “take the money and run.” Hopefully, building in to up front costs respect for lifetime costs will receive much more attention on the frontier. It will cost so much more on the

frontier to build anything, that the need to build right the first time should appear to be paramount to all. Cutting corners and costs are a hard tradition to break!

We intend to do separate articles on Horizon breaking superstructures on the Moon, and out-vac Signage. Designing with respect for the Moon is not a case of the Moon's sensitivity. It is an inanimate object. Rather it is a case of our own sensitivity and our own inner need to feel connected, of respect too for the adopted world's aloofness and mindless hostility to life. It is out of our desire to belong to the Moon, and to be her children as we have been those of Earth. Not all people are sensitive to such things, but we think that the desire for connectivity will be quite common among those who choose to forsake Mother Earth to be pioneers and settlers. The same for Mars.

### The Reds, the Grays, and the Greens

Kim Stanley Robinson coined the word "Reds" as a Martian frontier counterpart to our own "Greens." The "Reds" opposed terraforming, and wanted to preserve the character and integrity of Mars while finding ways to live on their new frontier in harmony with it. One can expect that on the Lunar Frontier, there will arise a "Gray Party" similarly concerned with maintaining a human presence on the Moon that pays respect to our new home. <MMM>

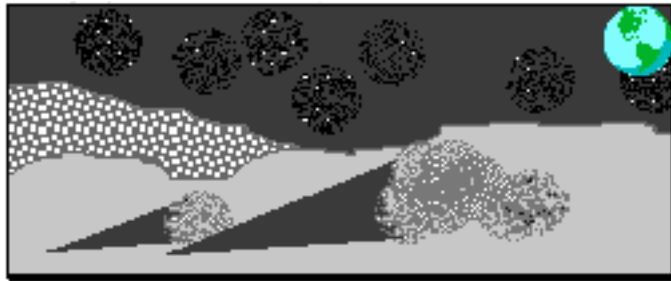

Nightspan Life — Out on the Surface!

"It was the nights before sunrise, and all through the town, moon folk kept cozy and busy deep down. But out on the surface, not a creature was stirring, not even a miner." Not!

As forbidding as it may seem to be out on the surface during nightspan, some Lunans will venture out there for work, others for play and recreation. It's all part of learning to be at home on the Moon.

## MMM #178 – September 2004

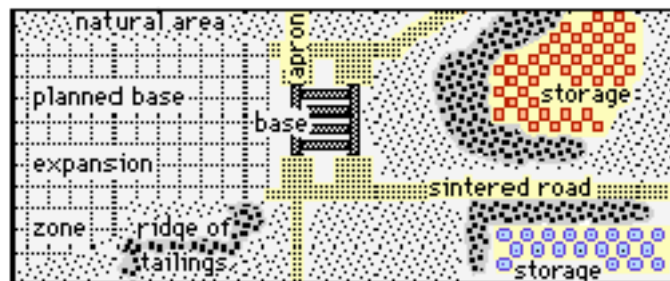

### Frontier Storage Chaos Solutions

In MMM # 90, November 1985, two articles, one on "Site Management," the other on "Warehousing" took a first stab at the problem. In this issue, we take up the topic afresh in "Storage, Storage, Storage, below. Tackling the storage problem will help lift up frontier settlements "by their bootstraps," improving their viability and survivability.

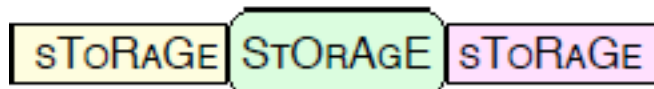

## STORAGE, STORAGE, STORAGE By Peter Kokh

**Definition:** The art and science of putting everything where it can be found and retrieved in good condition, suitable for use, reuse, or put to a new application.

Too many “full steam ahead” fans of progress and development, Green Peace is a dirty word. This counterproductive attitude arises from inborn human impatience. We want to get things done. We are impatient with “collateral casualties.” Over the long haul, that impatience can only bite us in the butt, to put it colloquially.

Green Peace is the activist environmental organization that is known the world over for its efforts to save the whales, disrupt French nuclear bomb tests in the Pacific, and much more. The organization has also concerned itself with changing public policies and business practices that have led to marked degradation of water quality in the Great Lakes.

But how many know of its work in Antarctica. In a fact-finding (busybody, some would say) mission to the main U.S. outpost at McMurdo Sound, Green Peace found a real mess. As our Antarctic operations expanded at this location over the years, the area became an unsightly sprawl of outbuildings, storage areas, and dumps – all with little or no preplanning. While our operations on the ice-bound continent had expanded markedly, the visual effect was one of a “trashed environment.” While the impact on local living systems may have been negligible, the impact on operational efficiency was major. We didn’t know where everything was: there was no rhyme nor reason to where things were stored.

The negative impact on our operations was clear. Our lack of well-thought out storage policies (or philosophy) led to things not being stored in a way that they could be easily found and retrieved in good condition, suitable for use, reuse, or put to a new application. We had not thought ahead to develop a sound storage management plan. The “trashing” that Green Peace found was but the tell-tale “symptom.” To the government’s credit (and Green Peace’s!) this situation was corrected. We are all happy campers now.

### **Lessons for future Outpost frontiers on Moon and Mars**

This is not off-topic. Without careful, thoughtful pre-development of a sound storage philosophy and management systems, we could end up with trashy surroundings. Much worse than the embarrassing publicity sure to be generated, we would be self-saddled with outpost operations that cannot function, much less expand, efficiently and in a timely way. Many of us are all too familiar with disorganization syndrome on a domestic level. We had tackled this general topic in two articles in MMM # 90 November 1995, “Site Management” and “Warehousing on Luna”:

[www.asi.org/adb/06/09/03/02/090/site-management.html](http://www.asi.org/adb/06/09/03/02/090/site-management.html)

[www.asi.org/adb/06/09/03/02/090/warehouse.html](http://www.asi.org/adb/06/09/03/02/090/warehouse.html)

### **Things we need to store**

Our first step is to develop an open-ended list of the things we may need to store outside our outpost proper. These things will fall into the following general categories:

#### **Incoming from Earth**

- Consumables from Earth: fuels and other chemicals;
- Food reserves and rations; initial and backup water reserves
- Replacement parts for structures, systems, and equipment
- Manufacturing supplies
- Modules to be installed, vehicles on standby
- Other items not needed yet accumulated on Location
- Samples (for mineralogical analysis and other scientific study) and for use in processing experiments
- Sorted samples by class: highland material, mare material; mantle material, KREEP soil (potassium, rare
- Earth elements, phosphorous); asteroid fragments
- Tailings from processing operations
- Other manufacturing or processing byproducts
- Assorted trash and detritus of operations including discarded and broken items & things no longer needed

- Human wastes and gray water
- Standby storage for items needed intermittently
- In transit from/to Earth or in space usage areas
- Locally produced fuels (liquid oxygen, silane, etc.)
- Manufactured products & sales inventories
- Artifacts created by local artists and craftsmen
- Incomplete assemblies (waiting for parts, etc.)

**“Cross-classification” by storage requirements:**

- Items that can be placed on the surface, out in the open, exposed to vacuum.
- Items best placed under a ramada or canopy to protect from solar UV, micrometeorites, or constant cycling between dayspan heat and nightspan cold.
- Items already carefully sorted that should be placed in bins or containers to avoid cross-contamination
- Items that should be stored in pressurized conditions
- Items requiring temperature controlled environments

**“A place to put everything and everything put in its place”**

It should be clear from the brief analysis above -- we make no claim that it is exhaustive -- will convince anyone that we cannot make do with just “a” storage location, and “additional overflow locations” as needed. While proper double bar-coding procedures can find anything no matter how disorganized the storage areas, witness the eventual remedy for Mir’s storage nightmare, efficiency in retrieval will obviously increase if things are physically stored in segregated locations, each with substantial room to grow.

Site Management will identify areas, out of sight of regularly used trafficways, where things can be properly stored. Then double bar-coding, of the item to be stored, and of the storage location or bin, will make everyone smile.

**Unique locations for storage**

Some natural surface features offer scenic segregation (though not from overflying craft) such as craters and the shadows of East-West running escarpments. Polar “permashade” areas offer permanent “out-of-sight conditions as well as stable very low temperature storage, ideal for items subject to decay at higher temperatures. Lava tubes offer all this and one thing more, an environment protected from the cosmic elements of cosmic rays, thermal extremes, ultraviolet, solar flares, and meteorites.

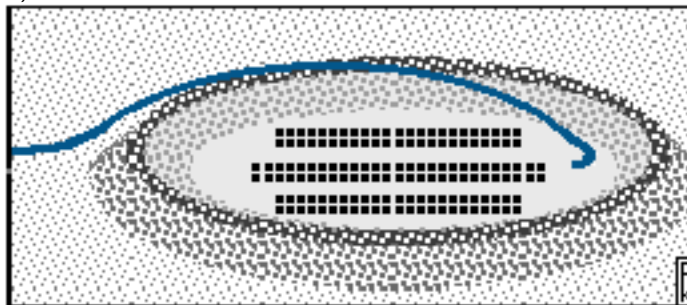

A graded road climbs up the shoulder of a stadium-size crater, across the rim and slowly ramps down the inner wall to the relatively smooth crater floor. Crater storage is attractive to hide stored items from view and also for storage of radioactive wastes. With no atmosphere to worry about, only line-of-sight radiation would pose a problem, and the crater walls would block that.

A similar “lee” or “soft” vacuum environment can be created by building ramada canopies or hangers for storage where lightweight, unhardened space suits can be worn, and glare-free, bright sky conditions maintained. “Underyard duty,” if one can call it that, will be much more pleasant and less stressful than similar duties out on the exposed surface. Ramadas can be built immediately adjacent to the

outpost complex (inyards) ideal for storage of routinely needed supplies, and in more remote locations (outyards.)

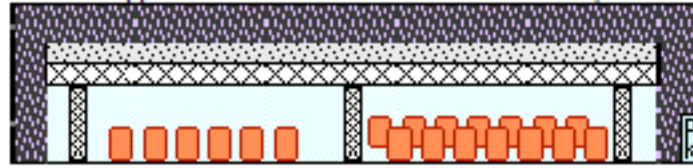

Here a space frame canopy covered with a meter or two of regolith provides protection from the cosmic elements of lunar “weather” including cosmic rays, solar flares, ultraviolet light and the incessant micrometeorite rain as well as providing thermal equilibrium -- protection from the monthly cycling of high dayspan heat and low nightspan cold -- all the while leaving the space underneath this “ramada” open to the vacuum. Ramada storage facilities will be ideal for items needing such protection, too sensitive or valuable to be left fully exposed. Ramadas extend that same protection to any storage management workers involved. In addition to ramadas, well away from the equator, block walls can provide dayspan long protective shade.

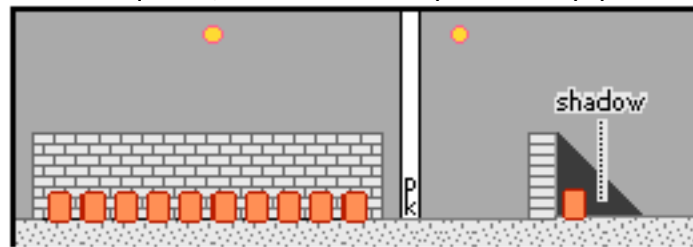

In this illustration, drums containing liquid and sludge wastes remain frozen and inert behind an east-west shade wall. This idea will work in the Moon’s “temperate” zones, north or south of the equator, where the sun is never overhead (the Moon’s axial tilt is negligible, 1.5°, the seasonal variation of the shadow angle is very low.)

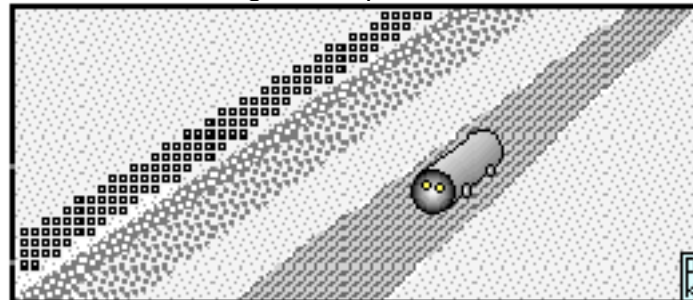

A berm along a highway provides both out-of-sight storage and the convenience of highway access.

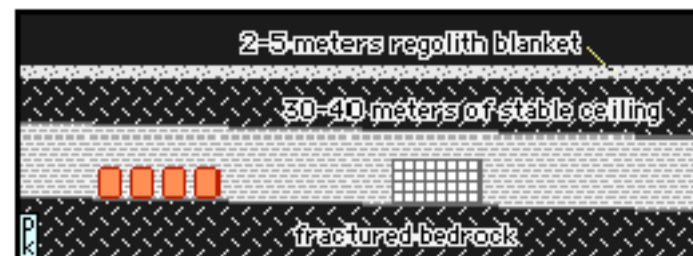

Storage in a stable lavatube with its gently sloping profile is the ultimate in lunar and Martian storage options. Enough protected and stable storage volume for all of the storage and warehousing needs for frontier civilization for generations, perhaps millennia to come. Even enough room to completely archive all of human history and civilization in a setting that should remain stable for billions of years to come.

Freight elevator shaft access from the surface would do the trick. Lavatube storage is also the ultimate solution for radioactive materials, toxic chemical wastes, and virulent biological pathogen collections. The Moon's lavatubes are an asset rivaling anything else the Moon has to offer, including farside radio silence and helium-3. Lavatubes are a naturally occurring feature in lava sheet flows such as the Moon's maria or seas, and in shield volcanoes. On Mars, storage immediately behind walls built perpendicular to the prevailing winds, will provide some harbor. Properly designed, they will reduce the accumulation of fine dust and sand.

### **Preventative measures**

On the Moon, with resupply windows virtually open around the calendar, the need to maintain a large inventory for replacement parts, equipment, and commodities will be much less severe than on Mars, where windows open up every 25–26 months. On the Moon, a “just-in-time” inventory system should be doable. Not so on Mars.

When it comes to inventories of reusable materials embodied in discarded items, “having it in storage” is not the same as “having it ready to fetch and use.” Whether it is a discarded appliance or vehicle or anything else manufactured of multiple, individually reusable parts, it makes sense to maintain a “just-in-time” inventory of disassembled items, properly sorted by material ready to reuse. Whether it be a routine chore of youngsters after school or on the local equivalent of Saturday morning, or of universal service work corps, the pioneers would do well to be handling the proper disassembly of discarded products as it comes in.

On the frontier, a lot of things will be in short supply, and losing track of things, or having things misplaced, or mixed and unsorted only exacerbates the problems and greatly handicaps the “resourcefulness” that is the pioneers’ main trump card, the “ace up the sleeve.” Honing their resourceful abilities be a frontier preoccupation. Storage Management starts with a philosophy, capsulated in a vision statement, and a comprehensive organization and logistics strategy, summed up in a vision statement, with periodic reviews and adjustments,

- Common sense – its where you put it when you need it – organization & logistics & efficiency & resourcefulness
- Respect for the environment, lifeless perhaps, but with a beauty not to be marred senselessly, but with art & plan.
- A plan for what should be stored, and stored separately so that it is a resource, not a waste nor a loss

On the frontier, the necessity of making the most of everything will be the mother of invention in storage, tracking, and fetching systems. One can even foresee a Byproduct Trade Exchange, all computerized and bar-coded, integrated with fetching & shipping systems, and automated order/import just-in-time software & distribution systems.

### **Incentives to help maintain discipline**

The most brilliantly crafted system is only as good as the discipline with which it is followed and respected. Tax and fine incentives are a time-honored way to increase the percentage of compliant “good behavior.” While on the Moon, where nothing can be taken for granted, citizen awareness of the need to exercise individual responsibility for keeping things working will be high. Yet the temptations of laziness, combined with probably all too frequent inconvenience of making the needed effort are sure to also guarantee that compliance will slack off with time. Help from the tax and fine codes might not be bad insurance. For individuals and companies alike, one good idea might be a tax on undisassembled discarded items, no tax on things properly separated and sorted. For companies with a need to remove byproducts and processing and manufacturing wastes off the premises, there could be a prohibitively steep fee for illegal “dumping,” a medium fee for taking to an approved storage location for unsorted materials, and no fee at all for storing items and materials properly sorted. To work, the fees would have to be higher than the costs of employing people or equipment to do the proper sorting and/or disassembly. Mechanization, containerization, and computer software will ease the burden and minimize both full- and low-exposure man hours. Promoting reuse and use of sorted materials. And the GST “Gross Settlement Throughput” Index

If there were a tax or price paid by manufacturers and processors on all use of virgin regolith, but no or a significantly lower fee or price for using tailings and other stored byproducts and any beneficiated materials or wastes, the total “throughput” or gross natural material consumption index of the settlement would be lower. The lower the ratio of virgin raw materials used to new products produced, the more efficient a civilization is in minimizing its impact on its host world.

Our impact on the lunar or Martian environments, while certain to grow, would grow more slowly in comparison to population growth. Again, prices have to be set at a level to encourage the desired corporate and individual activities, and should be adjusted regularly to fit changing conditions. Making sure Government policies do not work unless they affect individual behavior. It is the net change in total individual actions that makes a difference one way or another. Incentives are helpful, but not enough.

“Correct” action has to be made easy, easier in fact than lapsing into the behavior we are trying to remedy or eradicate. Nature, human nature too, tends to follow the path of least resistance. Individual economic decisions rule. Here is where most well intentioned official policy legislation falls down and becomes ineffective.

Thus a properly designed storage management system and coordinated recycling program must avail itself of helpful tricks. Color, pattern, and texture coding of the various receptacles will make choice of the right one easier. A computerized “Yard Guard” that recognizes a correct placement and notes that on the record of the person making the drop, rewards effort to “do it right.” Docking pay, or hours, for wrong choices will help too. “Anything worth doing, is worth doing right.”

#### **Implications for early frontier industry**

##### **The “Storage Industries”**

To begin this program at the outset of operations of the first outpost, all that will be needed is a vehicle that can pick up items to be stored, take them to an initial storage area that has been identified, and set them on the ground in an orderly fashion, separating them by type, and using a bar coder to tag both item and exact storage location. Such barcoding had been in use for at least a decade on Mir, with great success.

Then as each new industry comes up to speed, iron, steel, aluminum, cast basalt, glass, ceramics, glass-glass composites, and concrete it can use slack time from producing products for domestic consumption and export by making drums, bins, boxes, and stalls to hold items, especially regolith samples, and sorted discarded items, in a way that helps prevent cross-contamination.

Tailings from materials processing can be put to work in storage by piling them up as berms to visually fence off storage areas as they expand. Regolith that needs to be moved out of the way can be tamped into molds and sintered into construction blocks to make shade walls. Eventually, as we are able to make spars for space frames, probably from glass composites, we can start making hangers or ramadas covered with shielding for storing things that could be damaged by prolonged exposure to the cosmic elements, but do not need pressurization. In short no “new” industry is needed to get this program going.

##### **University Involvement**

Long before the first outpost-becoming-a-settlement sprouts an infant university, a University of Luna – Earthside will have become involved in brainstorming the industrial and commercial expansion and diversification of the settlement, endeavoring to keep several steps ahead of reality, lest growth be haphazard. The University, first from Earth, then on location, will take the lead in Storage Management Science, recycling systems, shepherding new storage related enterprises, aggressively developing new products that can recycle the many types of discarded items and materials, and working on marketing strategies. Marketing the storage management systems, know-how, and software that the University has developed and licensing of the manufacturing of field-tested storage related equipment and systems to other settlements, and to municipalities on Earth as well, help provide the University with some research and development income.



## Employment

On any frontier, “there are always more jobs needing to be done than people to do them. The Moon and Mars will be no exception. When it comes down to priorities the nod must go to jobs that produce saleable exports to earn credits to buy what cannot yet be produced locally, and for production of domestic goods, so that such items no longer need to be imported. That means, that as important as our storage endeavor is, we will need to rely as much as possible on mechanical and robotic systems for placement and retrieval of storage items, the cost of that equipment being far less than the real cost of diverting manpower to these task. People that must be involved will use automated and teleoperated equipment.

However, some tasks involved will be automation-resistant, such as disassembly of items so that individual components can be properly sorted and stored according to material composition. Some of these menial chores can be assigned to the settlement youngsters as after school or California Closets Goes to the Moon? Think of a disorganized storage area on the Moon as one big outdoor closet, jam-packed with assorted stuff in helter-skelter fashion, with no real way to find anything inside. The all-too-common domestic version of this chaos is what gave birth to the California Closets Company, the brainchild of a seventeen year old California youth who was soon employing both his parents. The company’s many novel solutions have all had their budget imitators, of course, many of them designed for the do-it-yourselfer. But this kind of left-to-itself disorganization is precisely the market on the Moon, Mars and other space frontiers for well-thought out and practical storage management systems.

## The Holy Grail

The Holy Grail of Storage Management and Reuse Systems is “to landfill nothing.” But once we adopt the principle and experiences some real time benefits, pioneers will be encouraged to reach new heights. Items that remain on the discard pile represent a loss of the energy invested in their original production. Replacing them means using ever more fresh regolith, when that may not be necessary. Of course such a goal will never be reached. But “we must aim high to hit the mark.

Meanwhile, what would have been landfill becomes organized invested storage. Properly done, little energy will be required to maintain this stored potential wealth indefinitely. Nor will the cost of land be a problem for some time. We’ll plan ahead for our storage islands, our “storage parks” integrating them into the planned frontier urban landscape, just as we do industrial parks. Properly screened with pleasant berms and other devices, storage parks will be good neighbors.

## The Upshot

Useless Diversion or an “investment in resource availability for the future? Nothing less than the settlement’s viability and survivability are at stake. Storing things so that they can be efficiently put back into use is but a concrete application of our pioneers “lifting themselves up by their bootstraps.” Not with the plan? Stay home!

Storage is not just about efficient housekeeping. It has environmental and economic significance. Establishing and maintaining the viability of settlements will be a constant uphill battle. The settlement that has its storage act together, will stand a better chance of still being around generations and centuries to come. < MMM >

**MMM #179 – October 2004**

**The Black Sky "Blues"**

**THE BLACK SKY “BLUES” Part III: Faux Skylights & Clerestories**

By Peter Kokh

**Previous: MMM #138 SEP 2000, p 4. The Black Sky “Blues”**

MMM #176 JUN 2004, p 7. “Black Sky Blues” Revisited

The skies of Luna will always be black and the uncomfortable glaring contrast with the overly bright sunlit surface will always be harsh. On Earth, water vapor in the atmosphere scatters the sun's rays so that light seems to come uniformly from all directions. Our atmosphere is a natural “diffuser” with a bluish cast. In the first article cited above, I floated this suggestion: “For those windows meant to bring in light but not necessarily the views, could we produce some sort of frosted and translucent, but not transparent, glass pane that will not only let in sunlight but appear itself to be bright, giving the illusion of a bright sky beyond? Again we but throw out the challenge. One might experiment by holding up various kinds of existing glass and diffusers to a streetlight against the dark nighttime sky.” The simple set of experiments is still worth making.

It might require dual panes set some distance apart. But even if this worked, it would introduce the problem of breaching the shielding blanket.

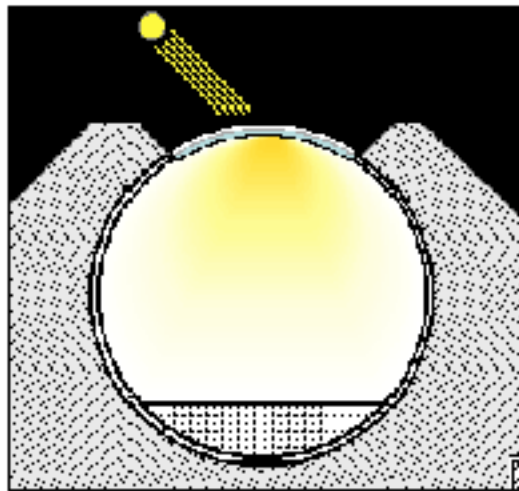

This breach creates an intolerable situation. This type of skylight could be permitted only in locations rarely visited, such as honeymoon hotel suites. Proper shielding should be preserved in all regularly occupied structures. But there are other ways to fool the eye with the desired uplifting effect. A shielded vault section could be suspended over a transparent glass skylight, its underside painted a bright matte blue. Sunlight would be funneled by mirrors to reflect on the underside of this outer ‘sky vault’ creating the illusion of a bright blue sky within the habitat.

These are admittedly very crude illustrations (in the absence of the services of a good illustrator, services MMM has lacked from the outset.) The engineering would differ from location to location depending on the latitude above or below the equator and the path of the sun across the sky. In this illustration, a vault, covers & shields, all vision angles through the skylight. Mirrors are shaped to scatter sunlight evenly via a fresnel lens.

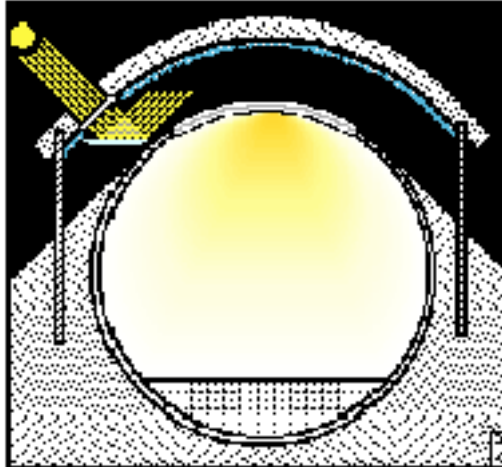

The skylight, as shown, follows the cylindrical or spherical shape of the module it is in. But in practice, the curvature should be inward, towards the pressurized interior as glass is much stronger under compression than under tension. During nightspan, an exterior sulfur lamp could take the place of the absent sun, using the same pathway. The skylight could also be shuttered as desired.

A properly done matte blue finish would seem to put the faux blue sky at an indefinite distance, increasing the illusion. Only reflected sunlight would enter the habitat area through the skylight. It is common practice on Earth to place skylights in north facing roof slopes (in the northern hemisphere) so as to feature the bright sky, not direct sunlight. So this arrangement would follow that practice.

Faux sky vault facing skylights could be installed in high end homesteads over a library, family room, or garden area. They might be more common in lunar settlement hotel atriums, in restaurants, and in corporate office foyers.

Future Lunan Pioneers will not give up access to sunlight and outside views. Neither will they long choose to do without bright blue skies. There is more than one way to skin this cat.  
<MMM>

## MMM #187 – August 2006

### Cities “Out There” (Xities) – Bringing Home the Difference

By Peter Kokh

In MMM’s 6th year, issues #s 51–60, December 1991 – November 1992 [republished in MMM Classics #6 available as a PDF file download from [www.moonsociety.org/publications/mmm\\_classics/](http://www.moonsociety.org/publications/mmm_classics/) one theme dominated the year: the vast and rather radical (root-deep) difference between cities as we know them, all within Earth’s biosphere and taking that biosphere for granted, and cities out there -- anywhere out there (other than planets around other suns, if those planets have a breathable atmosphere.)

MMMC #6 begins: .... **“defining how different city life would be beyond Earth’s cradling Biosphere. Cities out there, whether in free space as Gerald K. O’Neill envisioned, or on the surface of the Moon or other on worlds would be radically different. They would have to establish their own mini-biospheres, no longer something to be taken for granted, then learn to sustain them and live within them. This will change everything!**

“So radical will be the way cities out there will be built and run, that we cannot appropriately use the same word for them as we do for our familiar cities on Earth: whether

they be primitive prehistoric towns, third world megacities or the affluent cities in prosperous countries. They all get to take the biosphere for granted.

“Out there, our settlements will have to reprioritize everything. We need a different word for this different species of urban entity. **We call it the Xity:** X for “exo-terrestrial, not just beyond Earth, but beyond Biosphere I, Gaia.

“We pronounce it not EXity (it’s not ex- anything) but KSity, city preceded by a hard K, for the hard hull/shell that contains the manmade biosphere that pioneers now must nourish and care for as if their lives depended on it. for indeed, their lives will!”

We encourage readers online to download this volume of the MMM Classics and read it. Those not online may be able to access it at to a local library.

In these articles we discussed a lot of things: new departments of xity government tasked with maintaining the integrity and livability of the man-made mini-biosphere and pressure hull complex; with short-cycle air and water recycling; with education to help citizens do their part: how xity-architecture and urban planning will play key roles . We discussed Xities on the Moon, then on Mars, on Europa and elsewhere in the Outer Solar System, even aerial (aerostat) Xities high in the clouds of Venus.

We tried to illustrate the difference between city and xity from many points of view. Having just reread these 13-14 year old articles, however, new ideas for bringing home to the reader the crucial and definitive city/xity differences have occurred to us. Read on!

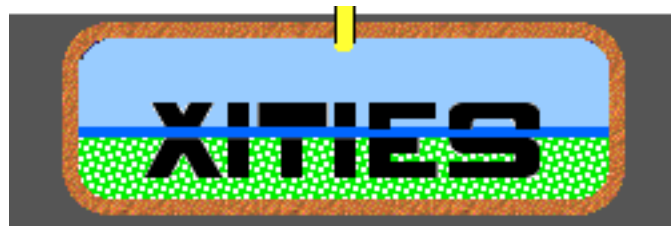

Xities beyond Earth’s Biosphere will be founded on a new contract between Man & Nature, a reintegration of urban and rural, of residential and agricultural, in which both humans and nature are much more immediately interdependent for survival. There is no more “downwind” and “downstream.” There is no more “somebody else’s backyard.” There is no more putting problems off to future generations. In contrast, “Responsibility” and immediate “self interest” will be one, not two in conflict. Making it work will be everyone’s job, not just the community fathers. There will be no room for “politics.” Survival will always be problematic. Alert status: maximum.

By Peter Kokh

Here on Earth, we have since time immemorial taken the global atmosphere, hydrosphere, and biosphere for granted. While destructive weather and locally catastrophic geological burps are problems, by and large, earth is a human-friendly place to live with lot’s of shoulder room, although through our rabbit-like reproductive instincts, this last feature is rapidly coming to a close.

When we invented agriculture and started domesticating edible plant species and animals, our farms and hamlets were close-coupled. In time cities arose populated by those engaged in other pursuits than agriculture. Farm and settlement entered a period of evolving disengagement, with many urban dwellers never experiencing farm life and food production activities. Cities became places where nature was present only as a landscaping token. Urban “parks” while helpful, are nonetheless still token. Citizens of denizens of cities grow up with a vastly distorted view of how much plant biomass is necessary to sustain fresh air, much less the food supply. Cities became places in which people kept houseplants.

**Symbols of Disengagement:**



Earth's atmosphere is vast: global and seemingly topless. Before the scientific age, most people imagined (some still do) that the atmosphere pervades all of space. That it is a finite blanket in which only so much can be dumped is just starting to be taken seriously, by some. Whether we are just heating our homes, or using heat in manufacturing, the nasty residue can just conveniently be dumped "downwind." Curbs on this practice are recent.

In Xities that contain and maintain a very finite atmosphere, there is no downwind. Everyone lives downwind of themselves. If you use a chimney or other exhaust device, what it pumps out you must inhale. Oops, we better do something drastically different. We can no longer count on the winds, the rain, the seas, and the forests to gradually cleanse our smoke and other dirty exhausts by the time the global winds bring it back around to us weeks later.

In xities, the long term recycling provided by nature on earth will not be available. We will have to use smoke-free, gas-free heating and manufacturing processes or find ways to scrub the exhaust before it leaves the confines of its generation. This will make xities out there radically different from cities down here.

**Symbols of Disengagement:**



It was way back about 2,500 B.C. in the Indus River valley (now Pakistan) in the settlement we call Mohenjo-Daro that urban sewage systems were first built. That made an immense difference. People were not wallowing in their own body wastes. What we have today is but a more sophisticated elaboration of this ancient prototype, a means of transporting the undesirable to somewhere else. Now, of course, we are mandated by law to treat sewage before it is allowed to enter nature's waterways. But Earth's hydro sphere being so massive and vast, "clean enough" is still far from clean. We rely on nature to finish the job.

In settlements out there, settlements that contain mini-biospheres that they rely on totally, there is not enough biomass and water reserves to "finish the job" of sewage treatment. We must devise more comprehensive systems. The water we flush will be the water we drink, much sooner than we think. There no "downstream" out there. Unlike citizens, xitizens will live immediately down-stream of themselves.

It seems to us that treatment must begin immediately, with in-home treatment of toilet wastes. The Wolverton graywater system, in which wastes are flushed into tanks inoculated with microbes to breakdown the pathogens as well as the solids, and which feed successive tanks and beds of first swamp plants, then marsh plants, bog plants and soil plants, continuously cleansing the water while the plants cleanse the air, is the way to go. Check out:

<http://www.wolvertonenvironmental.com/>

Every unit or module that has a toilet, be it residential, office, school, workplace, recreation area, etc. should be so equipped. That will greatly reduce the burden the xity waste treatment facilities must handle in order to produce water for agriculture, industry, hygiene, and drinking. It will also increase the amount of biomass able to keep the air fresh and sweet. Water in advanced stages or treatment can do double duty for landscaping, park streams and waterfalls, boating, etc.

**Symbols of Disengagement:**



Not long after the dawn of agriculture, cooperative farming began. People lived in farming villages, surrounded by their farms. Village and farm were separate but fully integrated. As cities developed to support marketing and trade, their integration with agriculture was less direct. As manufacturing arose, including the manufacturing of farming implements, the separation intensified. Nowadays it is common for city people to have never spent time on a farm, to have only a foggy and distorted idea of what is involved in bringing food to their table.

Because on the space frontier, cities and their farms must share the same contained atmosphere and mini-biosphere -- it will be the farm areas that keep the city's air fresh and sweet -- this separation will end. Unlike the aloof and separate city, the city will be fully integrated with the farms that support it. We will have come full-circle, back to the days of farming villages surrounded by their village-owned farmlands.

Forests and other natural planted areas will also be part of the city. The amount of vegetation mass needed to clean the city's air naturally is great. We can opt for chemical means, but that puts us at the mercy of engineered systems prone to breakdown. No city biosphere will ever have the guaranteed flywheel recycling system that Earth/Gaia enjoys, but the further we advance in that direction, the greater will be the City-Biosphere viability and security.

#### Symbols of Disengagement:



City dwellers simply have no concept at all of how great the support ratio is of hydrosphere to vegetation mass to people mass is. Not only cannot we live with the help of a few potted plants, we cannot live without the analog of an ocean. In a hull-limited biosphere volume, we cannot, of course have anything like an ocean. On the other hand, the "ocean" of Biosphere II, while at the time a bold step in the right direction, was pitifully inadequate and symbolic.

Having ample water reserves will provide security, greatly ease water recycling system engineering, support recreation, and provide a thermal flywheel to help even out internal dayspan-nightspan temperature variations.

Rain which helps cleanse and sweeten the air as well as water vegetation and clean paved surfaces, is unlikely to occur naturally in a mini-biosphere. It may need to be provided by ceiling sprinklers, or at best coaxed out of air that has become too humid -- not a comfortable prospect. Fountains and mists may be a workable substitute.

#### Symbols of Disengagement:

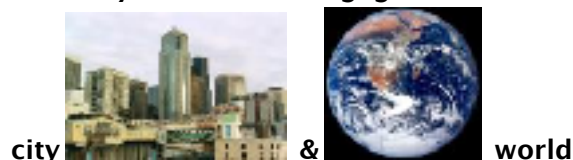

The ultimate disengagement here on today's Earth is that between the city and the living world at large, aka the global biosphere, personified as Gaia. On the space frontier, city and biosphere must be one and the same, united against the barren and inhospitable surroundings. Unlike citizens, citizens have no global biosphere to take for granted. They must create, nourish, and sustain one inside their own urban space. World, as livable, as nourishing, as enabling and supporting must be one with the city.

## Consequences

We talk these days about “permanent outposts” on the Moon and Mars, about putting down roots and staying. No small outpost can have a sustainable biosphere. We will not be on the Moon, or Mars “to stay,” all intentions, declarations and legislation to do so notwithstanding, until we build xities with a genetically diverse population of settlers, with a rich and diverse biota, with systems in place that will allow us to live immediately downwind and downstream of ourselves. That expertise will be a licensed export to Earth.

More simply said, humans cannot settle the space frontier -- not alone, not without taking Earth-life along to re-encradle themselves. In the process our civilization which now is a mess of disengagements of things that must naturally thrive together, will become whole again. Like a symbiote, we cannot live without our partner life system. Humanity and Gaia together will establish joint pockets beyond Earth. In contrast, “men bearing houseplants will go nowhere.” except to lay the foundations of future ruins.

We will, of course, have outposts, rural boondocks towns supporting mines, tourism, and other “parts” of global economies on new worlds. But long term, those smaller exclaves of humanity will not survive without supporting xities within practical reach. The same goes for spaceships spending long times “at space” between ports. Their food growing areas will be token and fragile. Without ports of call with established biospheres, they can probably not ply the space lanes for long. It follows that for rural outposts and spaceships alike, the bigger the better, because needed plant life requires acreage and volume. Think grand! “Larger” will be much less expensive in the long run. But we can expect that to be a hard sell to budget-minded myopic officials and administrators.

Our goal must not be to establish a “permanent outpost” on the Moon, or Mars, or anywhere else. It must be to establish Xities, not exocities, but miniature encapsulated Earths, viable populated biosphere systems.

Our cry is “Ad Astra!” Well, Xities come first. So let’s build Xities then. <MMM>

## From Outpost to Settlement: Telltale Signals of Passage

By Peter Kokh

We all realize that a tentative, toe-in-the-regolith base/outpost/beachhead must come first before real settlement can begin. There may be a public policy decision to go for “the next stage.”

But the transition could come by itself, in many seemingly minor changes of procedure and policy. The baby does not become an adult overnight, after all. Here are some of the things that will give us a clue that the process is underway.

- Operations transition from “mission-driven construction & exploration” to outpost growth and development
- Rigorous sterilization and quarantine procedures are abandoned as unnecessary ritual
- Operations slowly transition from “by the book” to experimental pragmatism -- individual initiative is allowed, then encouraged, in experimentation with processing, manufacturing, even with arts and crafts using local materials to give the outpost a “down home” facelift.
- Crew members are given permission to go outside alone
- Deaths occur from natural causes, and burial (of the body or cremains) is permitted
- Crew members are permitted to “re-up” indefinitely, giving them “vested rights” so to speak
- Relationships between crew members are tacitly accepted, even if official policy is unchanged.
- Permission for pregnancy is given after the fact and the pregnant crew member is allowed to carry the fetus to term without having to return to Earth.



- Someone “retires” from official duties, but is allowed to remain on location and tinker to his/her heart’s delight.

We welcome your suggestions to other “subtle” clues that the transition is underway. Such a shift in gears may not be planned. It will happen on its own, in due course.

### Anecdotal Signs

- The first MacDonalads, Starbucks, Walmart, etc.
- The first Lunar Olympic Events
- The first Lunar Soap Opera broadcast to Earth

It is fun to list things that will broadcast that the outpost beachhead “has arrived.” These things will come in time. But we are looking for the subtle first signs.

**Critical Mass** – The indications that the outpost-in-transition has become a settlement with “critical mass” to support “ignition” such as population size, diversity of factories, tools, vehicles, talent pool, reserves, etc. and the amount of vital needs and supplies in storage is another question. Here we are just looking for those first easy to miss clues that a historic phase shift has begun. < MMM >

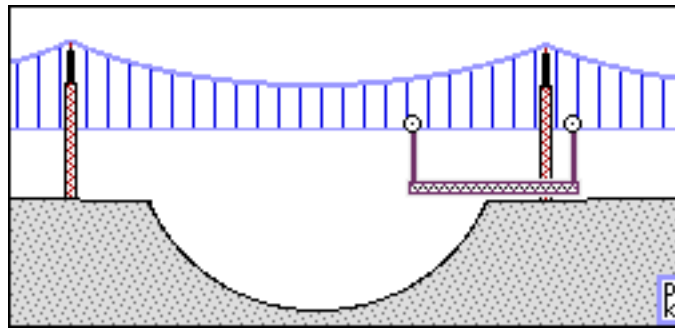

### “Bridging” Rille Valley Chasms Before Traffic Warrants Building a Bridge

By Peter Kokh

While the Moon has no water-filled rivers, it does have river-like valleys and chasms that present potential obstacles to road builders wanting to take the most direct route. Someday, we may find ourselves building bridges on the Moon, and Mars too, for the same reasons and in very similar situations.

While the maria are lava plains, much more easily traversed than crater-saturated highlands, they frequently incorporate lavatubes as part of the process by which the lava sheets spread across the basin. And lavatubes not sufficiently deep below the surface will have ceilings thin enough to have failed and collapsed resulting in a chain of pits or even continuous rille valleys. These valleys could lay astride otherwise logical transportation routes, presenting an obstacle. Detouring around the shortest section of the tube might detour involve extra drives from tens of miles to a few hundred, all out of the way: a lot of time and fuel would be wasted. At first there will be little choice. But as “traffic” develops, the incentive for some way to “bridge” or “ford” the gap will gain enough priority to trigger action.

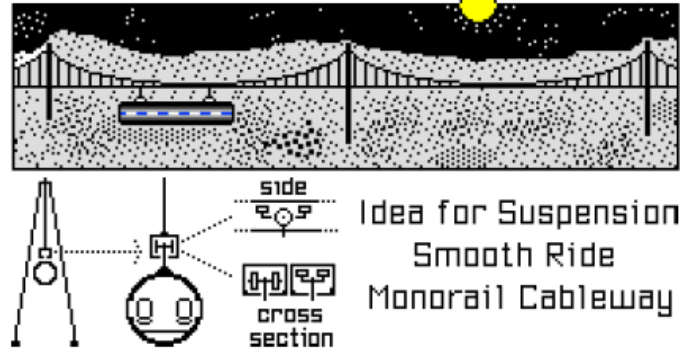

[MMM #169, October 2003, "Early Frontier Highways on the Moon"] Lighter, crater-pocked highlands surround darker and flatter lava flood plains, the 'maria.' But a mare may have several deep rille valleys (left) and flow front escarpments (top) and a few younger craters.

### Road building solutions

Switchback roads, carefully zigzagging down one valley wall to the bottom, then carefully winding its way back the other side might seem the simplest solution, involving not much more than one heck of a lot of grading. But in soil that is poorly consolidated, and prone to slides, this would be dangerous work for human-crewed road building equipment. Teleoperating such equipment would be safer for the pioneers, but involve no risk reduction for expensive equipment. It is not an ideal solution, the more so the steeper the valley slopes.

Of course, on the Moon where rights of way are of little concern, one could engineer a single long ramp down one side and another single ramp up the other, avoiding switchbacks which are accidents waiting to happen.

"Cut & fill" is a more ambitious and elegant solution is to do a procedure to build a direct and straight road across the gap by moderating the slope changes.

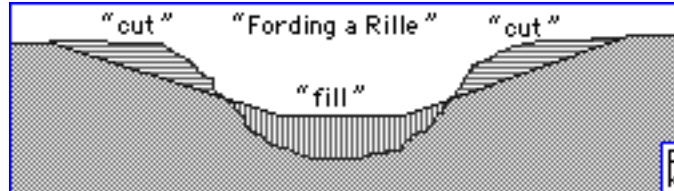

[ibid. p.6] "It may be some time before bridges and tunnels are built. 'Cut & Fill' is easier, less expensive, low-tech: ideal for a small population with limited industry. The lunar surface is bulldozable down to a depth of 2-5 meters (6-16 feet). Below that lies fractured bedrock. So major 'cuts' will need the assistance of dynamite or other explosives."

### Lighter Touch Solutions

It may well be much more expensive and require more materials and man hours of labor to build a bridge than to cut & fill a landfill causeway. Yet there may be reasons why we want to, or decide to, tread with a lighter foot on the lunar landscapes, preserving them as integrally as we can in their natural state.

The problem is the cost. Does the foreseen growth in traffic warrant that expense? That a bridge is more convenient is not the point. Where the valley is deep and the slopes steep and treacherous, making traditional road-building approaches more difficult and dangerous, the bridge will loom more attractive.

Yet the expense of building a bridge could be a lot for the young frontier government to handle. We'd like to suggest a step-at-a-time bridge building approach by which key elements are built first, other elements phased in as the growth of traffic warrants.

### The Proto Bridge

There are a growing number of types of bridge architectures. While the earliest bridges may have been fallen logs over small streams and brooks, or carefully placed stepping stones in a shallow river bed, the early true bridges were supported from below by a masonry arch, or if needed, by a series of arches: this method was elaborated further to build aqueducts and their close cousin, the elevated canalways of Britain. The wooden trestle bridges of the early railroading days also are supported from below. But this is as much an incursion on the vallescape as a cut & fill causeway, even if more appealing to the eye.

The suspension bridge and its more recent take-off, the cable-stay bridge, are products of the industrial revolution with the heavy use of iron and steel. We think that the suspension approach is ideally suited for the Moon. Once the towers are in place and the cables strung, traffic can hover above the otherwise undisturbed moonscapes allowing them to remain more natural and rustic. We have already talked about using cableways for tourists in especially scenic areas, along valley shoulders, crater rims, and mountain ridges. By having the cable car ride a second cable -- or a box beam -- below the support cable sagging between towers, a more level ride can be provided.

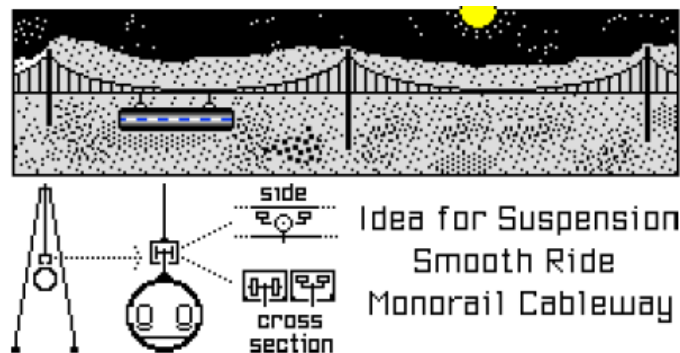

### A "Ferry Crossing"

While we may well see cableways continue over rille valleys, the idea here is to build a "ferry crossing" using elements of the above-described suspension cableway system. Two towers and two anchor points are needed, one of each on each rille valley shoulder. A single suspension cable is slung from anchor to tower top to tower top to anchor. From it is suspended a box beam in which a pair of trolley boogies can ride, holding up a flatbed car, built to carry land vehicles from side to side.

The ferry parks on one side, the destination side of its most recent traverse, waiting for customer traffic. It is fully automated, so that it does not matter if the wait is minutes, hours, or days. If a vehicle approaches from the side on which the ferry waits, it drives on and uses the appropriate radio frequency to activate the controls. Once on the other side, the vehicle driver tells the flatbed ferry to wait in park mode, and drives off the other end to continue its journey. If a vehicle approaches from the side opposite to that on which the flatbed ferry is parked, the driver signals the ferry to cross so that it can be boarded.

### From single to double suspension ferry to full bridge

Such a system postpones the erection of a second twin cable and suspended box beam as well as of a roadway supported between them. As traffic becomes more frequent the second suspension cable/box beam pair can be built so that two flatbed ferries can cross in the same or opposite directions at the same time. Now the stage is set for building a true bridge roadbed when traffic becomes so frequent as to warrant it.

If traffic never grows beyond the capacity of the first phase, nothing is wasted. And that is the beauty of the Suspension Ferry system. It is self-sufficient, but can be the start of a full-fledged roadway bridge.

### The role of Bridges in the history of civilizations on Earth

Many major cities have grown up around the junctions of roads and rivers. Bridges were built where rivers were narrowest and most easily spanned. Bridges have united communities

that had sprung up on both sides (Buda + Pest => Budapest being but one example) and have allowed other cities to expand to the “other side.” ... and on the Moon (and Mars)

More importantly, bridges are logical pinch points for transportation. Traffic funnels from various angles on both sides to the Bridge crossing, and thus into and through the city built around the bridge. This is true even where, in advance of a bridge being built, a regular service ferry crossing is established. River cities have become major gateways to virgin lands beyond (e.g. St. Louis) The pinch point inevitably becomes a major regional center of trade, commerce, culture, and recreation.

Cities grow up around other seeds, of course, such as where river meets shore or at entrances to mountain passes. We discussed how the lay of the land and transportation routes would determine where thriving settlements would spring up on the Moon in MMM #140 November 2000.

Suspension Ferry Crossings that provide shortcuts across mare rilles and similar obstacles will attract convenience travel centers, and possibly settlements. Thus, erection of a cable suspension ferry crossing will appeal to entrepreneurs who want to get in on the ground floor of a potential successful new settlement and market center. It could well be an enterprise that builds the first such system rather than a frontier government. Of course, a frontier government led by forward thinking leaders might well start the ball rolling by seeking suitable enterprise partners. After all, what’s good for business is good for taxes!

Not all river crossing, river–spanning cities have names that reflect that fact. But some do: Harper’s Ferry, Bridgeport, Rockford, Sioux Falls, Grand Rapids, etc. It is possible that some future lunar towns will be named in part for there valley spanning function.

#### **The Moon is more than a gray, monotonous rubble pile**

The more one gets familiar with the lunar globe and maps, the more the nuances which make this gray rubble spot different from that one begin to suggest a world of possibilities – indeed, a human world of possibilities! The idea of suspension ferry crossings that span rille valleys is just one example. The more really familiar with the Moon you become, the more concrete the potential of settlement will loom. <MMM>

## MMM #191 – December 2005

# ALUMINUM WINDOWS

### **Safer Windows for Spacecraft & Surface Vehicles? A Solution for Some Lunar Architectural Challenges?**

[sources: Google.com: ALONtm]

By Peter Kokh

Well, windows of a **new ceramic aluminum oxynitride rather than aluminum alloy**, actually. Trade named ALONtm [no, that’s not ALON™] this new material is being tested at Army Research Laboratory at Aberdeen Proving Grounds, Md., and University of Dayton Research Institute, Ohio adjacent to Wright–Patterson Air Force Base. The driver here is to come up with a superior transparent window for hummers and other vehicles at high risk in Iraq. But the implications for safer vehicles and structures in space are what interests us.

#### **ALONtm research to date**

ALONtm is a ceramic material with high strength under compression, superior impact resistance, and superior abrasion resistance. It is lighter weight than traditional multilayered glass windows with which armored vehicles are now being outfitted.

Lighter, thinner, stronger, longer lasting – is there a downside to this new miracle material? Cost is currently a problem. \$10–15 per square inch as compared to \$3 for multilayered glass now in use. But that should not be of concern to anyone familiar with the downward cost curve of any newly introduced product. As more efficient ways are found to process the material, and mass production is introduced, costs should fall substantially. After all, and this is something few of our readers under 70 will be aware of, when the commercial products made of the new miracle alloy “aluminum” first appeared, they were astronomically expensive. Aluminum is now very affordable, no longer in the Platinum cost range. In fact, it is now a “common” material.

#### **Drivers for development of ALONtm**

The need for protection from road side bombs in Iraq, and from terrorist threats in general, is driving this research. That the R&D is being done by the military means that all the money needed to be thrown at it, will be.

We can feel confident that this technology will be available commercially without too much delay. Armored vehicles used to transport millions of dollars in gold bullion or paper currency between banks, are logical early users. Once the cost becomes competitive, if not lower than armored multilayer glass, more commercial applications will appear. Wherever wealth or political clout makes someone a target, there will be a premium on “the best protection.” But we see a big market for ALONtm windows and portholes on the space frontier.

#### **ALONtm windows on tourist craft and orbital hotels**

Sometimes, the enemy is none other than ourselves. This is certainly the case with the growing problem of space debris in low Earth orbit, almost all of it avoidable for the cost of a few added measures and procedures. [See MMM ##31 DEC '89, “Space Debris: cleanup & prevention” p1 – included in MMM Classics Vol. 4 available as a free PDF download from [www.moonsociety.org/publications/mmm\\_classics/](http://www.moonsociety.org/publications/mmm_classics/) Larger, safer ALONtm windows in tourist spacecraft and tourist hotel complexes in orbit will be demanded by both would-be tourists and the insurance industry. The cost of minimizing risks will be more than made up by the overall fall in ticket prices by a greater volume of tourist traffic driven by the realization of higher safety levels, less risk.

Yes, it is true that the likelihood of an impact from a debris particle of size sufficient to cause vehicle or structure decompression is low, it is getting ever less so. It is clear that the public regards the 1 in 50 chance of losing a shuttle too high, and the first such debris-impact decompression fatality will have a very chilling effect on the infant space tourism industry. Commercial vendors and fliers of tourist vehicles will be happy to pay any extra cost that reassures potential customers. A century ago, had we the technology to go into space without the current culture of risk-aversion, no one would have hesitated. But these days, the public believes everyone should be guaranteed to live to a “ripe old age.” That’s nonsense, of course, but that is the depth of cowardice to which we have now fallen. It is going to be difficult to populate a frontier given this culture.

The risk of a debris or micrometeorite decompression accident beyond low Earth orbit falls substantially, but once it is common practice to equip space vehicles and living spaces with ALONtm panes, they will become standard. Even where there is a low incidence of risk, the cost and great inconvenience of changing a window out in the open, as opposed to inside a pressurized “garage” would make the higher protection worth additional cost. Apart from greatly improved failure protection, the fact that ALONtm is significantly more abrasion resistant will make vehicles so equipped very attractive, especially on Mars where wind-driven dust is expected to be a real problem. ALONtm windows remain clear, glass gets sandblasted to a state of translucency without transparency.

#### **ALONtm windows for habitats and other structures on the Moon and Mars**

We personally, have always believed that television screens and monitors are no substitute for actual vision when it comes to keeping in touch with the outside world. Electronic devices can always be fed a misleading signal, and they just do not convey the same sense of immediacy. Our interest in such devices as periscopic picture windows had a lot to do with the

birth of Moon Miners' Manifesto in the first place: our belief that "Lunans may have to live under-ground, but they won't have to live like moles. They can bring the views and the sunshine down underground with them." [Cf. MMM #1, December '86, now online, fully-illustrated: [http://www.lunar-reclamation.org/mmm\\_1.htm](http://www.lunar-reclamation.org/mmm_1.htm) ]

Many articles have appeared since then in MMM in which the use of windows was central. Here are but a few:

- # 74 APR '94, p 6. Visual Access; p. 7. Sun Moods
- # 75 MAY '94, p 4. Lunar Appropriate Modular Architecture
- #124 APR. '99, p 4. Windows Focused on Earth
- #132 FEB. '00, p 8. Skylight Domes for Lavatube Towns

Also see: [http://www.moonsociety.org/chapters/milwaukee/mmm/mmm\\_1.html](http://www.moonsociety.org/chapters/milwaukee/mmm/mmm_1.html)

Realizing that exposed glass would lose its transparency over time due to micrometeorite and dust abrasion, we postulated a loose "sacrificial" pane in front of the window, that could easily be replaced. But the superior qualities of ALONtm would make such replacement much less frequent. Even if ALONtm was used just as a replaceable weather shield, its value would be significant.

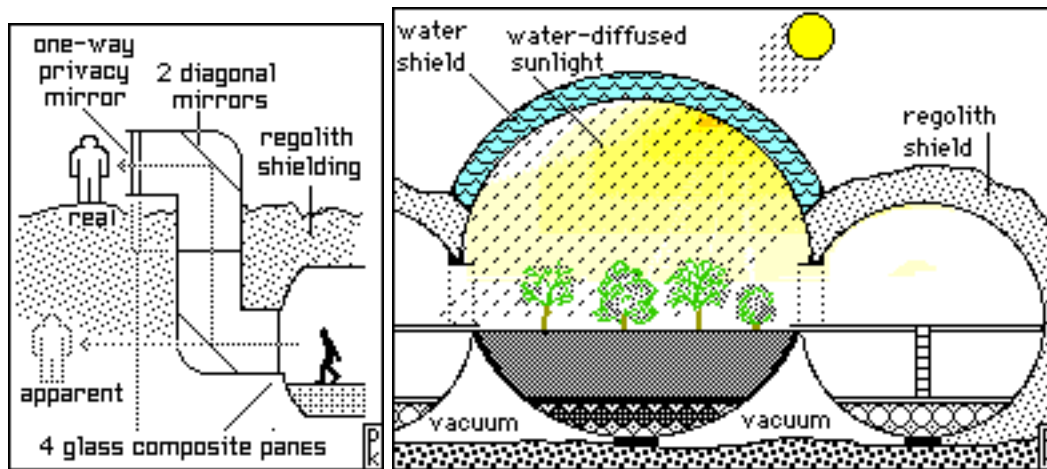

If costs every plunged to the point where ALONtm panes could compete with ordinary glass, then they could be used for the convex facets of a lunar geodesic dome type skylight. Convex or inward curving panes would take advantage of the fact that ALONtm is stronger in compression. However, any direct path visual or solar access, unless seldom used by any one person, would provide severely insufficient shielding against cosmic radiation and solar flares. That's why the periscopic window illustrated, at left above, makes use of a zigzag pathway. Why not store water overhead, within a double layered glass dome, as translucent shielding? This is a suggestion of Marshall Savage (Millennium Foundation).

You will notice that in the illustration above on the right, while from the outside, it looks like a dome, the true nature of this structure is a sphere which better handles the pressure loads. Now this is a neat idea, but the water would have to be circulated to prevent freezing or boiling (in lunar versions). Thermal management will be a major part of any such design, and a lot of homework and trial and error prototype demonstrations need to be done here on Earth with sun/heat/cold loadings that simulate the proposed environment (Moon or Mars). And now that both the domes "glass" layers could be made of ALONtm instead of glass, makes this suggestion somewhat more practical, provided that the plumbing systems to manage the thermal swings can be perfected.

Can we have translucent shielding without water? Glass, if it is thick enough, or in enough layers to provide shielding (6-13 feet!) loses its transparency and even its translucency. It would be interesting to see how much light is lost per mm or cm of ALONtm as compared with the same thickness of glass. If ALONtm is a sufficiently more efficient transmitter of light, it might make some new architectural options possible.



Recently, a form of concrete has been produced that is translucent, not transparent (you can see someone's silhouette but not make out the details). Read about it at: <http://optics.org/articles/news/10/3/10/1>

"Thousands of optical glass fibers form a matrix and run parallel to each other between the two main surfaces of every block," says inventor Áron Losonczi. "Shadows on the lighter side will appear with sharp outlines on the darker one. Even the colors remain the same.

All these new wonder materials will in time open up exciting new options for lunar, and Martian architecture, just as they are sure to do sooner, here on Earth. In ALONtm, we have what could be a wonder material whose further development and application will be abundantly funded by both military and civilian consumer interests. The offshoot will be a safer, and perhaps more pleasant life for those who pioneer worlds beyond Earth's life-supporting biosphere. Windows, skylights, solar access for homestead gardens and greenhouses, revolving restaurant observation towers over Luna City or Marsport. Ceramic aluminum, made of everyday elements, has a role to play.

A lesson that younger readers can take away from all this is that all the excitement is not in propulsion science. A career on the new frontiers of Materials Science can help as much or more open the space frontier. The Rocket guys can get us there. It will take the Materials Science guys, the chemical engineers, the experimental agriculture people and others to help us find a way to stay on that frontier, and to make it just as much our own as has been the planet of our birth. Plus, there's money to be made advancing materials science right her and now. <MMM>

## **MICROWAVE OVEN TECHNOLOGY**

### **For Road Building on the Moon and for much, much more!**

By Peter Kokh based on a report online at:

[http://science.nasa.gov/headlines/y2005/09nov\\_lawnmower.htm?friend](http://science.nasa.gov/headlines/y2005/09nov_lawnmower.htm?friend)

#### **A matter of perspective**

Sometimes, quite often in fact, the problem is its own solution. It's a matter of looking at it right. "If some-thing seems like a disadvantage or a liability, you aren't looking at it from the right angle!" is a bit of wisdom from my Mother that I have found to be the key to paydirt many a time. Moondust is insidious. It gets into everything, and it is everywhere on the Moon, the product of four plus billion years of micrometeorite bombardment.

Larry Taylor, Professor of Planetary Sciences at the University of Tennessee, as he has a habit of doing with everything (including a bar of Irish Spring soap), put some moondust from NASA in his microwave oven, and within seconds, even at low power setting, it fused into a glob.

You see, one of the omnipresent ingredients of moondust is microscopic particles of iron. We all know well enough not to put metal in a microwave! The iron in the moondust absorbed the microwaves, heated up, and fused all the moondust! Eureka! The brainstorming began!

#### **What can you do with microwave-fused moondust?**

Well suppose you put your microwave magnetrons on a wheeled carriage and drove it (in person, or more likely, telerobotically) over the terrain?



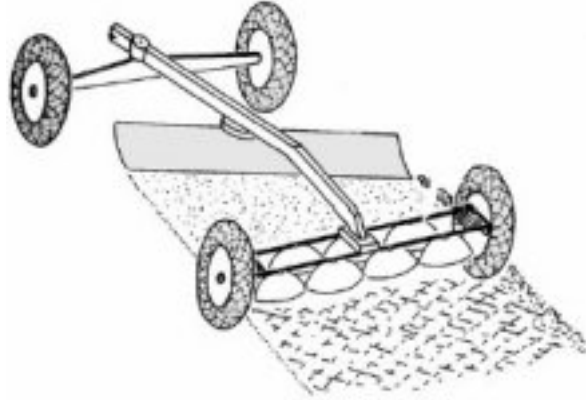

Cartoon sketch by Larry Taylor, U. Tennessee

“With the right power and microwave frequency, an astronaut could drive along, sintering the soil as he goes, making continuous brick down half a meter deep--and then change the power settings to melt the top inch or two to make a glass road.” Taylor calls this the lunar lawnmower, though that implies an operation that has to be done often.

**Send us your suggestion** for a more appropriate metaphor? email us at [kokhmmm@aol.com](mailto:kokhmmm@aol.com)

Taylor suggests that bricks could be made this way and that we could even fuse the inner slopes and floors of appropriately sized craters into reflective bowls that would serve as Arecibo like radio telescopes.

**A family of applications** – (suggestions by this writer)

A device like this could **“fix” the “apron”** surfaces around docking ports and airlocks, lessening the chances that moon dust would get carried into the pressurized areas. That’s really “job one” in road building. To paraphrase an historic quote, “all lunar roads begin and end at an airlock.”

One can imagine a **hand held unit** that one would wave briefly over one’s space suit, especially arms, gloves, legs and boots, fusing the dust into clumps that would shake off, and do no harm even if carried inside. But the settings would have to be low enough to cause no accumulative damage to the human inside. We all know that microwave ovens won’t work with the door open, and there is a very good reason for that!

Inside, a takeoff on the hand held unit above would be magnetron-equipped **vacuum cleaners attachments**. The fused dust would be more easily and thoroughly sucked up.

Such a process might have architectural applications as well. Consider the lunar settlement’s surface appearance as a collection of inter-linked molehill mounds – the regolith shielding piled on top of habitation structures being the public face of the settlement from outside. An affluent person could have his “mound” fused, and maybe in some pattern forged as the mobile fuser’s route could be chosen for such special effects. As the microwaves can reach some distance down, a mold of some neutral iron-free material could be placed and tamped on the mound section by section and the soil fused beneath it. The mobile unit would then raise the mold, wheel to the next area, tamp the mold down, fuse, etc.

Mold fusing could become an inexpensive way to produce many products for both domestic and commercial use, for both lunar and off-Moon markets – where performance was not a critical issue. How brittle would such artifacts be? How susceptible to cracks? How susceptible to corrosion and decay by exposure to water, or even to humid interior atmosphere? We don’t know the answers to those questions. How much experimentation can be done here on Earth (with lunar simulant?) and how much corroborating experimentation will have to be done on the Moon? All we can do is carry terrestrial experiments as far as we can.

Can you see a terrestrial application of such technology? Why not develop the technology for profits here and now, while putting a needed lunar technology “on the shelf,” the research paid for by terrestrial consumers?

## An invitation to brainstorm

What other possible applications are there? “The only limit is imagination,” says Taylor. More importantly, the answer is really up to those of us who can take it to the next step. Might that mean you? <MMM>

MMM #198 – September 2006



## Technologies Needed to Break Free

By Peter Kokh

Despite the best of current announced intentions, it is politically and economically predictable that NASA’s lunar outpost (even if is “internationalized” by taking on “partners” in a contract) will be stripped of any and all features seen as “frills” or “extras.” Consider how the planned 7-man International Space Station was summarily slashed without partner consultation in the stroke of a presidential pen to a 3-person one: 2.5 persons needed for regular maintenance and a half-person is available for scientific research. It can and will happen again, unless ...

It becomes our cause, the accepted challenge of those of us who owe it to our own dreams, to do every-thing in our power to get the outpost built, outfitted, and supplied on a more rigorous and stasis-resistant path. The/a lunar outpost must be designed with expansion in mind, with a suite of easy expansion points, expressing an architectural language that is expansion-friendly. No all-in-one “tuna can stack,” please!

To this end, we must reexamine every aspect and angle of setting up a lunar outpost.

### **I. Transportation System Architectures: Designing cannibalizable items for strategic reuse in Earth-Moon Transportation Systems.**

**NOTE 1:** The author is not a rocket scientist, engineer or architect. The examples given below may not all be feasible, but we hope that those that are not, will suggest other possibilities that are worth exploring.

**NOTE 2:** We do not expect NASA to embrace any revolutionary space transportation system architectural turnabout. But it is something that commercial space transportation providers might do well to study.

**NOTE 3:** Those in the business may be quick to insist that these ideas are all impractical. So be it. They are not part of the solution. We are looking not for those who say “it can’t be done,” but for those who say “we’ll find a way to do it anyway!” If it were not for the “Young Turks” in various fields, we would all still be swinging from the trees. We must find the hidden, unsuspected pathways!

Way back in MMM #4, April 1987, we pointed out that Marshall McLuhan’s dictum that “the media is the message,” might be transposed to “the rocket is the payload.” Of course, you can only push this so far. But this daring architectural philosophy offers the best way to escape the imagined, unnecessarily self-imposed tyranny of the mass fraction rule. “Of the total

weight, 91 % should be propellants; 3 % should be tanks, engines, fins, etc.; and 6 %t can be the payload.”

<http://www.allstar.fiu.edu/AERO/rocket5.htm>

We are not talking about exotic fuels or better rocket engines, but ways to include the 3% “tanks, engines, fins, etc.” into the payload.

In the case of the Shuttle, the mass of the vehicle is much greater than the mass of the payload, so we do not come close to the ideal. At the time (the April 1987 article), I offered this simple example. In the shuttle space transportation system, the payload that gets to stay in orbit is a needlessly small portion of launch vehicle mass.



Adopting philosophy “the rocket is the payload” we could, if we so dared, deliver much more to orbit.

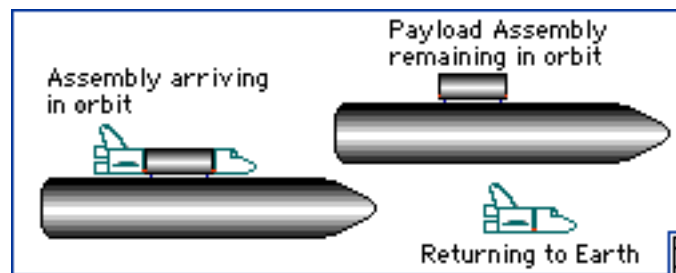

In the suggested alternative, the orbiter has a fore and aft section: Crew Cabin and Engine pod with much smaller wing/tail assembly. There is no payload bay. A much larger payload, with a lightweight faring if needed, takes its place. The External Tank is also placed in orbit as part of the payload. A stubby shuttle is all that returns to Earth. Savings include not just the payload bay section but the much lighter smaller wings and tail. The article referred above to is reprinted in MMM Classic #1, p 10, a freely accessible pdf file at:

[www.moonsociety.org/publications/mmm\\_classics/](http://www.moonsociety.org/publications/mmm_classics/)

Again, don't waste time writing MMM with all the reasons this couldn't be done. Instead, consider yourself challenged to figure out how we could do this anyway.

This is only one suggestion of how we can “cheat” the mass-fraction “rule.” The shuttle system will not figure in the establishment of a lunar outpost. So it is not these details, but the spirit behind them that we are trying to get across. Attitude, attitude, attitude!

### **Terracing the way back to the Moon**

It seems unlikely that the Lunar frontier will be opened with vehicles that depart Earth's surface, make the entire trip out to the Moon, and land on the Moon's surface directly. So what we have to examine is all the various parts:

- Earth surface to LEO (low Earth orbit) transports
- LEO to Earth Moon L1 or Low Lunar Orbit ferries
- Lunar orbit to lunar surface landers

At each phase, if the vehicle addresses the design challenges, material and/or useful assemblies and subassemblies can be deposited at the next. Whether it be all in one ride, or by a succession of waves, more payload gets delivered to the Moon's surface, and/or more robust way stations are constructed in LEO and LLO (low Lunar orbit) or at the L1 Lagrange point. No opportunity is missed. See “The Earth-Moon L1 Gateway” MMM #159, OCT 2002.

We would be remiss if we did not point out that one of the most brilliant components of the **Artemis Project**<sup>™</sup> Reference Mission architecture involved just such a mass-fraction cheating device: reduction of the portion of the landing craft that “returns” to the open-vacuum

“space motorcycle” I think it can be shown that most objections to this design as vulnerable to micro-meteorite impact are baseless. Micrometeorites strike the Moon, and spacesuited astronauts!, on the surface, with velocities much higher than the velocity such a craft would need to reach lunar rendezvous orbit. It was the incorporation of this feature that allowed the Artemis Project™ ferry to deliver the relatively massive triple unit SpaceHab-based outpost core to the surface.

Whether the Artemis Project™ Reference Mission will fly as designed is not our topic and irrelevant. The point is that it demonstrates, at least in this instance, the kind of breakthrough paradigm-scuttling innovation that alone will get us to the Moon “to stay.”

### **Stowaway Imports: smuggling more to the Moon**

Another article we wrote that suggests ways to “smuggle” more useful material and items to the Moon is “Stowaway Imports” in MMM #65, May 1993. This article is republished in MMM Classics #7, freely downloaded at [www.moonsociety.org/publications/mmm\\_classics/](http://www.moonsociety.org/publications/mmm_classics/)

The idea here, is that it is inevitable that there will be structural, outfitting, or packaging items aboard craft landing on the Moon that are not needed for the return to the vehicle’s base, be it in LLO, LEO, or Earth itself. The cost of getting these items to the Moon is prepaid as part of the cost of getting the payload consist to the Moon, whether or not they remain on the Moon or not. So if we leave them there, these items are a bonus.

Packaging containers, stuffing, dividers, etc. can be made of items not yet possible to duplicate on the Moon: some Moon-exotic element such as copper, or an alloy, some reformable plastic, biodegradable materials useful as fertilizers, nutritional supplements, whatever. Everything not absolutely needed for the ride back is game for scavenging. On crewed vehicles this can consist of everything from tableware to bedding, to appliances and even cabin partitions.

Some items can be thoughtfully predesigned for second use on the Moon as is. Others will be melted down or reformed for the useful material they contain. It’s all free, or at least at less cost than replacing them for the next outbound trip to the Moon. Only the “squeal” need return!

Designing moon-bound craft to be cannibalized in this fashion will require resourcefulness, and exploration of a lot of options, some more promising and less difficult than others. Stowaway imports are a way to supplement what personnel on the Moon will be able to produce or fabricate for themselves, thus leading to swifter development of a more diversified lunar startup economy.

Cargo craft landing on the Moon might be designed for one way use only. Fuel tanks will be prize imports, landing engines may be reusable for surface hoppers. The idea is to build these craft cheaply and in numbers, much in the mold of WW II “Liberty Ships.” If some crash or go astray, the loss will not be critical.

In our Lunar Hostel’s paper (ISDC 1991 San Antonio, TX – [www.lunar-reclamation.org/papers/](http://www.lunar-reclamation.org/papers/)) we introduced the “frog” and the “toad” – Moon ferry under-slung crew cabins that could be winched down to the surface, lower its wheeled chassis, and taxi to the outpost: amphibious space/surface craft. The “frog” would return. The “toad” would be designed to spend the rest of its service life on the Moon as a surface transport “coach.”

### **Modular Transportation**

One of the more outstandingly successful innovations of modern transportation is the pod. Cargo in uniformly sized and shaped pods is transported on trucks, flatbed railway cars, and ocean going cargo ships.

The space transportation industry, especially the commercial sector, would do well to develop standardized pods, not waiting upon NASA clues which may never come, simply because the need does not arise in the very limited NASA lunar outpost mission plan. There may be more than one pod design, however, depending on the nature of the cargo. Liquids and aggregate materials (a load of wheat, for the sake of an example) may require container constraints, for shipment through the vacuum of space, that large assemblies do not.

The pod agreed upon would have significant repercussion for modular systems shipped to the Moon: modular power plants, modular water recycling systems; modular regolith processing systems; modular food processing systems; modular hospital cores; the list of possibilities is endless. No one size is ideal for all applications. However, we suggest that the current modular factory system serve as a model and size guideline, as it has proved remarkable successful. See MMM #174 April, 2004 “Modular Container Factories for the Moon.”

Such a pod could also deliver inflatable modules to the Moon, which could then be outfitted on location, with cannibalized components and/or items manufactured by startup lunar industries. The result would be quicker build-out of the original outpost structure.

### **Transportation Systems Architecture Upshot**

If we intend to expand the outpost into a real industrial settlement on an “inflationary fast-track” – the only way it can be done economically – the Earth-Moon transportation system must be so-designed from the gitgo, down to the last seemingly insignificant detail. A missed opportunity could spell the difference between success and failure. Our purpose in giving the examples above is less to fix attention to our examples than to get across the spirit. Spacecraft architecture, systems architecture, industrial design for reusability as is or with minimum processing effort, choice of materials, etc. And all vehicles at every stage should be designed this way.

Again, these lessons will be lost on NASA as its objectives are strictly limited: to deploy a moonbase in order to prepare for manned exploration of Mars. “.” But commercial providers are likely to look for more extensive use of their products, for other more open-ended markets. It is with them that all hope lies. Those that adopt the above philosophy as a cornerstone of their business plans are more likely to survive and thrive long after NASA’s government-limited goals are met.

## **II. An Expansion-friendly Modular Outpost Architectural Language, and Construction/Assembly Systems Design**

### **Back Reading:**

MMM #5 May ‘87 “Lunar Architecture”, MMMC #1

MMM #75 May ‘94 “Lunar-Appropriate Modular Architecture” MMMC #8

MMM #101, Dec. 96 “Expanding the Outpost”, MMMC #11

This is one area in which the **Russians** and **NASA** with its various **contractors**, have already done considerable research and have acquired invaluable inflight/in use experience in the **Mir** and **International Space Station** programs. Happily too, a commercial contractor, **Bigelow Aerospace** is now making groundbreaking contributions with inflatable module technology, borrowing heavily on NASA’s Congress-aborted TransHab project. The prototype one quarter scale inflatable **Genesis I** is now in orbit and rewardingly performing well.

Modular architecture developed for the micro-gravity of Earth orbit will certainly have applications in the return to the Moon effort. It will apply directly to any way station developed at the L! Gateway point or in lunar orbit. But applications to the design of lunar surface outposts will need some rethinking for four reasons:

We are now talking about a 2-dimensional environment stratified by gravity, not the any-which-way dimensions of orbital space. The 1/6 Earth normal gravity environment mandates an established up-down orientation, no “swimming” through the air to get from one point to the other. This is minor.

Egress and ingress portals need to be designed to minimize intrusion of insidious moon dust. It would be ideal if spacesuits were rethought with this challenge in mind, but NASA has already signaled its intention not to explore that route for money reasons. One more sorry instance of a “stitch in time, saves nine.” NASA operations on the Moon will be far more expensive to maintain than the relatively trivial expense of wholesale spacesuit redesign even at

multimillion dollar expense. Commercial contractors may be the Knights in Shining Armor here as the NASA approach would be indefensible in any business plan.

Outside the safety of the Van Allen belts, radiation protection is required for more than short stays. The lunar surface station must be designed to sit under a shielded canopy, or to be directly covered with a regolith blanket. An added benefit will be thermal equilibrium.

While NASA, its contractors, and the Russians have a head start, it should never be assumed that they have explored all the options. Modular architecture is very much structured like a language: it has nouns (the various habitat and activity modules), conjunctions and prepositions (the various connector nodes), and verbs (the power system, the Canadarm and other associated assembly and arrangement tools). The idea in constructing a “lunar-appropriate modular architectural language” is to come up with the most versatile, yet economic in number, set of modular components to support the most diverse and varied layouts and plans. The idea here is to maximize the options for expansion, without prejudging what needs will be accommodated first in the buildout.

We think that this concept is important enough to put to a design competition. NASA, contractors, the Russians can all advise on interface constraints and other design features that must be incorporated. Then let the would be Frank Lloyd Wrights of the lunar frontier have at it. We predict some novel suggestions that NASA and commercial contractors may want to adopt.

We have suggested in Part I of this article, that modules should fit (yet-to-be-)standardized Earth-Moon shipping pods. The cheapest way of providing maximum elbow room, in the era before modules can be manufactured on the Moon out of lunar building materials, will be inflatable modules. Easy to deploy “outfitting systems” for these inflatable units are another area worth exploring through the device of an international design competition. The inflatable manufacturer can set the constraints which will include interior dimensions, purchase points, and ingress opening sizes. Then let the contestants exercise their varied inspirations.

Onsite manufacturability of needed components would be a design goal: maximum use of low-performance cast basalt, glass composite, and crude alloy items should be the preferred contest category. This way, expansion develops hand in hand with early startup industries, and becomes a strong incentive for their earliest development, saving substantial sums over importation from Earth.

Expanding on this theme, even equipment in hard-hull modules arriving fully outfitted from Earth might be limited to subassemblies of components not yet manufacturable on the Moon. A very simple example would be cabinets, tables, floor tiles, even chairs without horizontal tops or seats. These could be made of cast basalt, saving some weight in shipment. Many more possibilities of this compound sourcing paradigm are worth exploring: wall surfacing systems, simple utensils, appliance chassis, etc. See MMM #18, Sep. '88, “Processing with Industrial “M.U.S./c.l.e.” reprinted in MMM C #2.

We mentioned the need for shielding. The development of simple canopy framework systems that can be locally manufactured, then covered with regolith, would be invaluable. Such canopies could protect stored fuel and other warehoused items that need to be accessed regularly, so that personnel could do these routine chores in less cumbersome pressure suits as opposed to hardened spacesuits. Such canopies could also serve as flare shelters out in the field at construction sites or at periodic points along a highway. An easily assembled (teleoperated?) space frame system with a covering that would hold a couple of meters (~yards) of regolith should be another design contest goal.

### **Modular Power Generation, Storage, and Heat Rejection Systems**

This is a suggestion that NASA may well not bother considering. The initial outpost power generation and storage systems and heat rejection systems should be designed with modular expansion in mind. NASA will not be reflecting on the needs of expansion because its government mandate does not extend to expansion, unless space advocates force a change,

even if “just to leave the door open for commercial developers who may follow.” We think such activism is worth the effort.

### **Introducing Load-based Modular Biospherics**

In our opinion, NASA’s performance in developing life support systems has been hit and miss. Chances to incorporate a higher level of recycling on the Space Station were passed up in the name of up front economies, even though such systems will be absolutely vital on the Moon and Mars. To its credit, the agency does have the BioPlex project in full swing in Houston. But we worry that the outcome will be a centralized system that will work for the designed size of the lunar outpost, and not support further expansion.

The centralized approach to biospherics has a famous precedent: Biosphere II. We think centralized approaches are not the way to go. Instead, we should develop load-based decentralized systems. In this approach, wherever there is a toilet – in a residence, a workspace, a school, a shopping area, a recreation space, etc. there should be a system to pretreat the effluent so that the residual load on a modular centralized treatment facility is minimized. The Wolverton system is what we have in mind.

If all outpost modules with toilets have built-in pretreatment systems, then, as the physical modular complex grows by additions, the “modular biosphere” will expand with it. Expansion will not race ahead of the capacity of the contained biosphere to refresh itself.

Another essential element of modular biospherics is having plants everywhere. A phone-booth sized salad station will not do. Useful plants can be grown throughout the lunar outpost: they can provide additional salad ingredients and meal enhancers: peppers, herbs, spices, even mushrooms. Even decorative foliage and flowering plants help keep the air fresh as well as provide a friendly just-like-home atmosphere. Plants in front of any window or viewing portal would filter the stark and sterile barrenness outside.

Plants must not be an afterthought. We cannot long survive, let alone thrive as a species that hosts houseplants. We are a species hosted by the lush vegetation of our homeworld. We should never forget this. We cannot go with the attitude of “let’s build some cities, and a token farm here and there.” Rather we must go to build a new vegetation-based but modular biosphere which will then host our settlements.

City dwellers all too easily discount the farm. We have houseplants as botanical pets. That paradigm won’t work. Designing all habitation and activity modules to house plants as an integral feature will help allow the biosphere to grow in a modular way along with the physical plant. It will be a more enjoyable place to live as well.

NASA is unlikely to pay these suggestions a glancing thought. We hope that commercial contractors, whose long range plans are not limited by governmental myopia are more farsighted. Modular biospherics should be part of their business plans for any industrial settlements or tourist complexes on the Moon.

### **Teleoperation of construction & assembly tasks**

So far we have been talking about architectural considerations that would prime any startup lunar outpost for expansion, no matter how restricted its mandated goals. But expansion, as well as original deployment, requires construction and assembly. To the extent that individuals in spacesuits are involved in this work, it will be dangerous and risky. Human manpower hours on the Moon will be expensive to support. Loss or incapacitation of just one person in an outpost construction accident would be a major and expensive one.

In order to maximize crew usefulness and productivity as well as health and safety as many tasks as possible should be designed for remote operation by persons safely inside the outpost or construction shack, or by teleoperation by less expensively supported people back on Earth. The latter option may be more technologically demanding but it is far more preferable. Every construction operation tele-controlled from Earth frees personnel on the Moon for things that only personnel on site can accomplish. The result is progress is surer,



safer, and yet quicker. The outpost is up and running in less time, with everyone healthy and ready for real duties.

In the following article, page 7 below, we take up this fascinating topic of pushing the limits of teleoperation, surely a prime area for engineering competitions.

### **III. Locate for local, regional, and global expansion options**

The writer's position on moonbase siting is well known. We have no problem with being all alone in seeing a lunar south polar outpost as a dead end. But we hope that commercial contractors will be more farsighted. The problem is that we need to plan not just one outpost, but an outpost that can be a center from which an industrious human presence will spread across the lunar globe.

In their very well brainstormed proposal outlined in "**The Moon: Resources, Future Development and Colonization**", David Schrunck, Burton Sharpe, Bonnie Cooper, and Madhu Thangavelu present a comprehensive plan for establishing such an outpost at the south pole and for spreading out from that center across the globe via an electrified lunar railroad. We certainly support the latter idea and have written independently on the feasibility of electric lunar railroads.

But we fear that south pole advocates have discounted the dangers of operating in a polar environment, in mountainous terrain, where the sun is always at or just below the horizon or immediately above it casting constantly shifting "blackhole-black" long shadows. We also suspect that the difficulty of deploying a solar power tower system in mountainous terrain is not addressed. That the nearest highland/mare "coast" where resources of both terrain types needed for industrialization are accessible is 1,300 miles distant is another overlooked disadvantage. That sunlight is available 86% of the time does not erase these drawbacks.

Water-ice exists at the poles. But hydrogen is everywhere on the Moon in the regolith, ready to harvest. As much as we need water, we will use far greater tonnages of other materials. Do we bring Mohammed to the Mountain or the Mountain to Mohammed?

There is, it seems, an unstoppable bandwagon for the South Pole. Commercial contractors interested in developing lunar resources and/or tourist facilities, are likely to take a second look. Our hope lies with them.

A NASA-International lunar polar outpost may survive, minimally manned to tend astronomical observatories in the area. If we mine polar ice preserves it makes more sense to do that in the north polar areas. If the observatories go unsupported, one day, lunar tourists may visit the historic ruins at the South Pole.

### **Parts IV & following, Next Month**

In next month's installment of "**The Outpost Trap: Technologies Needed to Break Free**" we will talk about ISRU, In Situ (onsite) Resource Utilization, processing the most common elements in the regolith and producing building materials. We cannot thrive on oxygen alone! Any effort to do so will end in outpost termination.

We will also explore the ways to get lunar industrialization off on the optimum path to a logical diversification that will build upon itself and reach import-export expense-income breakeven as quickly as possible.

Lastly, we will explore the demands of the most critical of all moonbase systems, without which all the rest, no matter how well designed, will collapse, or at the very least totally preclude civilian expansion of the kind most of us want to see: "the human system". This is the system currently being viewed with the most rusty-hinge horse blinders, and not just by NASA.

#### **Meanwhile, a parting thought**

While no one has ever established an outworld outpost before, we humans have certainly had plenty of experience in establishing new frontiers. There is a substantial reservoir of experience here throughout human history and in many human cultures, on which to draw.

Establishing an outpost, whether or not new and complex equipment is needed, is much more than a matter of nuts and bolts, of engineering and rocket science. To rely solely on the insights of experts in those professions will only gain us an expensive collection of hardware on the Moon. It will not gain us the open-ended establishment of a civilian, resource-using presence bent on making itself as much “at home” on the Moon as we have always done, over and over, everywhere that we have pioneered new frontiers on our home world.

In a sense, this will be a second Cradle Breakout. We are, you see, already an infraplanetfaring species. We have already settled new “worlds” in our “Continental System” beyond home continent Africa. The next step is only a continuation. But we must rely most of all on our instinctive cultural wisdom based on millennia of experience by endless waves of pioneers who have gone before. The upshot is that NASA and other agencies must fit in our plan, rather than we in theirs.

Much of the expertise needed will have to be developed or at least rethought. Here we need to rely not solely on those “tasked” with working on the project. After all, it is our project, not theirs, and no government has the right to exclusively appoint any set of specialists to the task. This frontier like all others, will be pioneered by rebels, by those unhappy with the status quo, by Young Turks who dare to look at old problems in a fresh light, by people who are willing to dust off the countless pages of abandoned research, looking for promising turns in the many “paths not taken.”

And we need the entrepreneurs who will develop these new technologies now, for profitable terrestrial applications, but ultimately to put them “on the shelf” just in time where lunar pioneers can find them when needed.

As a Society tasking ourselves with doing what we can to make it happen, we need to seek out “adventurous expertise”, well researched but yet open minded persons who will make the breakthroughs, large and small, that will help realize the dream. <MMM>

## MMM #199 – October 2006



### Technologies Needed to Break Free

By Peter Kokh

#### IV: ISRU, In Situ (on site or on location) Resource Utilization

NASA's announced intention is to begin a modest program of ISRU, in the form of oxygen production from the regolith. A major problem with the plan has emerged, however: NASA is designing the Lunar Ascent Module to use fuels that do not include oxygen! Yet oxygen is not only needed for life support, if transported to Low Earth Orbit, it can be used on the next run out to the Moon, saving the major expense of getting oxygen-prefueled vehicles up from Earth into LEO. We hope that NASA is not dissuaded from going ahead with its modest and limited ISRU project, however, as it will be just the beginning, the first step in using “on location” [Latin “in situ”] resources. [Since this was written, BASA has indeed scuttled its ISRU oxygen production plans.]

**First, the basics**

We need to begin with basics, such as cast basalt and sintered iron fines collected with a magnet. These can provide abrasion-resistant chutes and pipes and other items for handling regolith, and low performance metal parts respectively. Then we can handle regolith more effectively to feed additional ISRU projects.

### Composite Building & Manufacturing Materials

Long before we can produce iron, aluminum, magnesium, titanium and workable alloy ingredients, we can make useful building materials out of raw regolith and minimally enhanced regolith. processing elements and building materials from the regolith. Using highland regolith with a higher melting point to produce glass fibers, and mare regolith with a lower melting point to produce glass matrix material, we can produce glass-glass composites on the analogy of fiber reinforced resins (fiberglass). But to make this work we need to bring down the melting point of the mare glass matrix material further by enriching it with sodium and potassium. (A study funded by Space Studies Institute recommended the expensive import of lead as a temperature-reducing dopant!) This gives us an action item: isolating sodium and potassium, or sodium and potassium rich minerals.

If we can also isolate sulfur, we can experiment (and yes, why not here and now?) with fiberglass-reinforced sulfur matrix composites. Simpler yet, we can make many low-performance household items from “dishes” to planters to table tops and floor tiles from crude raw glass and cast basalt, no processing needed other than some sifting.

We will bet that glass composites, sulfur composites, cast basalt, and raw basalt glass will all find profitable terrestrial applications which may make the predevelopment of these technologies attractive to entrepreneurs, thus putting at least a close analog of technologies needed on the Moon, “on the shelf,” in a reverse of the usual “spin-off” sequence. We call this “Spin-up.”

### Metal Alloys

Using **ilmenite** (we can now map ilmenite-rich mare deposits on the Moon) we can use this iron, oxygen and titanium mineral to produce all three elements. It is the first ISRU Suite to be identified. We need to identify more such "suites". Lunans will not live by oxygen alone!

**Aluminum**, abundant though it is, might be the hardest to produce, magnesium, somewhere in between. The catch is that for all four of these “engineering metals” the elements we regularly combine them with in order to produce workable alloys are rare on the Moon. For iron and steel we need carbon. For aluminum we need copper, and to a lesser extent zinc.

The action item here is for metallurgists down here on Earth to dust off old alloy experiment records. Some pathways, while doable, promised less superior results, and may have been abandoned. If they involved alloy ingredients that are economically producible on the Moon, we may have no choice but to go down that route to see where it leads. We need to do research now on lunar-feasible alloys that will perform in a “second-best” manner. Second best is better than nothing.

At a minimum, we need to be able to isolate, or produce, not only the four engineering metals, present on the Moon in parts per hundred, but all the elements present in parts per 10,000. See middle square below

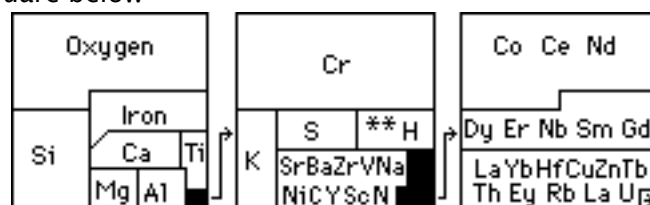

Read: “Beneficiation” MMM #63, republished in MMM Classic #7, [www.moonsociety.org/publications/mmm\\_classics/](http://www.moonsociety.org/publications/mmm_classics/)

NASA page: <http://ares.jsc.nasa.gov/HumanExplore/Exploration/EXLibrary/docs/ISRU/00toc.htm>

## **Agricultural Fertilizers**

From past NASA experiments with the Apollo Moon samples, we know that regolith has about half of the nutrients needed for healthy plant growth. Using gas scavenging equipment on board all earth moving vehicles (road construction, shielding emplacement, material for processing and manufacturing) we can use the harvested carbon and nitrogen and hydrogen to make fertilizer supplements. Potassium we will find in KREEP-rich deposits around the Mare Imbrium rim. Other elements hard to produce on the Moon can be used to manufacture cannibalizable shipping containers and packaging materials, to “stow away” on a ride to the Moon.

### **Let there be color!**

Combine humidity, likely to be higher in pressurized habitat spaces, with the iron fines in regolith and we get rust for a splash of color. Titanium dioxide produced from ilmenite will give us white. Combine rust and white and we get a pink. Black, many gray shades, white, rust and pink. The rest will be harder. Metal oxide pigments will be a secondary goal in our processing experiments.

### **Using the Slag and Tailings**

Slag and Tailings are in themselves “beneficiated” stuffs from which we can probably make many low performance household items and construction elements. Doing so will reduce the “throughput” of our young lunar industrial complex. By treating these byproducts as resources rather than as waste (“wasources”) we reuse the energy that was used to form them. This will work to greatly reduce what the settlement “throws away” – the goal being “nothing!”

### **Export Potential**

Killing two birds with one stone has always been a desirable strategy. ISRU products from oxygen to metal alloy and non-alloy building and manufacturing materials will reduce the need for expensive imports as Lunan pioneers learn to make more of the things they need to expand their settlement and outfit it in a livable manner.

But for long-term economic survival it is essential to go beyond reducing imports. There will always be some things the settlement is not large enough, and its industries not sufficiently diversified to produce. There is a need to pay for these imports. We cannot rely on any long-suffering generosity of terrestrial taxpayers. We can pay for our imports with credits from exports. Now in addition to proposed energy exports, and various zero-mass exports ranging from communications relays to broadcasts of unique lunar sporting (and dance) events to licensing technologies developed on the Moon, there is an area of real material exports.

As long as one thinks of Earth as the Moon’s only trading partner, this prospect seems outrageous. Shipping costs would make lunar products very expensive. On the contrary, it is shipping costs that will be the settlers’ trump card, if there are other markets developing side by side in space. For example, while lunar building and construction materials and outfitting products may seem crude and unrefined to us on Earth, if they do the job, we can deliver them to low Earth orbit commercial space stations, orbiting industrial complexes, and orbiting tourist hotel complexes at a definite advantage over any competitive product that has to be boosted up from Earth’s surface. It’s not the distance, but the gravity well difference. For any product we make, as far as in space markets go, Earth will not be able to compete.

We have to think of the future economy as including not just Earth and the Moon, but other areas in nearby space that will become areas of human activity. This market will continue to work to the advantage of the rapidly diversifying lunar economy and growing lunar population as the population in orbit continues to grow, and as Mars begins to open up. It can only get better. But ISRU, not just of oxygen, but of many elements, and materials made from them, is the key.

### **ISRU and Rare Elements on the Moon**

Dennis Wingo, in his recent book [Moonrush](#), sees the Moon as a potential source for platinum needed for fuel cells to make the forecast Hydrogen Economy work. None of the samples returned by the six Apollo landing missions and the two Soviet Lunakhods showed this

element to be present in more than parts per billion. Now you can say that we only sampled eight sites. Not quite true when you consider that at any given location on the Moon, only half the material is native, the other half having arrived as ejecta from impacts elsewhere on the Moon. In that sense the areas of the Moon samples are somewhat representative. Wingo argues that platinum-bearing asteroids had to have bombarded the Moon. We do not quarrel with that. But it is likely that the infinitesimal smithereens are scattered all over the place with no enriched concentrations anywhere. Now we'd be happy to be proven wrong.

Geologist Stephen Gillett, University of Nevada-Reno, and an expert on lunar geology, now thinks that the way to beneficiate (increase the concentration of) scarce elements is to feed regolith to bacteria in vat cultures, the bacteria having been bioengineered to feed preferably on given elements.

Dr. Peter Schubert of Packer Engineering in Naperville, Illinois outside Chicago, has developed an on-paper process, patents pending, that would use shoot regolith into a 50,000 degree (C or F?) laser beam and separate out the various elements and isotopes and direct them to separate catching containers. This is, of course, the ISRU process to end all ISRU processes. We are not qualified to estimate what is involved in development of a working demonstrator, or at what scales this process would operate most efficiently. It does seem to require a considerable energy input, perhaps from solar concentrators. It offers a glimpse of the future, when lunar settlements are shipping megatons of sorted elements for construction projects in space. (L5 revisited.)

### Summing Up

- ✓ **We cannot thrive on oxygen production alone!** We need to concentrate on other ISRU goals, especially ISRU Suites or Cascades in which more than one element results.
- ✓ **We need to enable with research now, early industries** that fill needs and defray imports – Building, Construction and Manufacturing materials
- ✓ **We need better, higher resolution global lunar maps**, that show not just where we will find regolith enriched in iron, calcium, thorium, and KREEP (what we have now, at least at poor resolution.) We need orbiting instruments to indicate the richest concentrations of many other elements we will surely need. **Action item:** suggest to NASA in detail, the kind of instruments it should fly on planned orbiters.
- ✓ As this information comes in, keep **reducing the long list of settlement locations to a short list**. What we have noted already, demands, if we truly want lunar industries and industry-based settlement, to look elsewhere than the highland-locked poles. What we need is a Highland/Mare Coast, near ilmenite and KREEP deposits. That would give us access to all the major and most of the lesser abundant elements present on the Moon. But we may have to establish a number of settlements, each in differently endowed locations. After all, one settlement does not make a "world!"
- ✓ We must **research reuse options for pre-beneficiated tailings** as building materials with lesser performance constraints. On Earth, there is no shortage of abandoned piles of tailings with which to experiment. Entrepreneurs, like artists, love free materials.
- ✓ **Many experiments are possible with obvious terrestrial applications** which may prove profitable.
- ✓ We need an **organizational machine that will work to identify all these research needs** and attract effective attention to them, serving as a catalyst to get the work done.
- ✓ **The goal, if we choose to accept this mission, is to return to the Moon, ready to start building-out the first resource-using settlement**, so that the NASA Outpost can do science for a while, then retire to become an historic lunar national park site. In short, our goal is "Escape from the NASA Outpost" – returning to the Moon with the tools needed to avoid the "Outpost Trap."

## V: Industrial Diversification Enablers

### 1. Accepting the dayspan-nightspace energy challenge

It is not enough to develop the technologies needed to turn on-location resources into products for domestic use and export. We have a little quirk in the way the Moon does its own business, rotating in and out of sunlight every lunar “day” that presents a considerable challenge. The Moon’s “day” is almost 30 times as long as the one we are used to.

The challenge is to find ways to store up as much energy as we can during the 14.75 Earthday-long dayspan as potential energy, to keep us running on a lower but still productive level through the 14.75 Earthday-long nightspan.

Yes, that’s why so many lunar advocates are drawn like moths to the eternal sunshine of very limited and rugged areas at the Moon’s poles. But if you read the last two pages, you will know that except for water ice, the resources needed to build an industrial lunar civilization lay elsewhere. We will have to ship the ice to the settlements just as we ship the oil from Alaska’s north coast to California.

There is no way to avoid taking on the dayspan–nightspan challenge. Turn aside from the challenge and we may be limited forever to tiny ghettos’ at the lunar poles. Accept and win the challenge, and the Moon is ours, all of it.

The options for dayspan storage of energy to use during nightspan are treated in other articles. See: MMM # 126 JUNE ‘99, p 3. POTENTIATION: A Strategy for Getting through the Nightspan on the Moon’s Own Terms – This article has been republished in MMM Classics #13 as a free download pdf file at: [http://www.moonsociety.org/publications/mmm\\_classics/](http://www.moonsociety.org/publications/mmm_classics/)

## **2. Accepting the reduced nightspan power challenge**

We might think of the pioneers waiting out the two-week long nightspan playing cards, writing their memoirs by candlelight, and making love for want of something else to do. But if we successfully meet the dayspan power storage problem, the pioneers will have enough energy to continue being productive by focusing and concentrating on less energy-intensive and perhaps more manpower-intensive tasks and chores, leaving manpower-light and energy-intensive processes for the dayspan. Inventory, scheduled maintenance, product finishing, packaging and shipping, etc.

The challenge is to take every operation and sort it into the two kinds of tasks or steps stated above. Not every industry is going to lend itself easily to an equal “division of scheduled labor.” Some will need more man-hours during the dayspan and have few assignments to keep as many people busy during dayspan. Other industries may present the opposite situation. One can see arrangements where some employees work for company A during the dayspan and company B during nightspan.

Can we come to a plan whereby everything evens out and everyone is kept busy all “sunth?” (the Sun appears to revolve around the Moon once every 29.53 days, whereas the Earth does not, i.e. sunrise to sunrise marks the period we know as new moon to new moon, “month” for us, “sunth” for them. I digress.) We have stated an ideal. In reality, a lot of trial and error and the steadily increasing diversification of lunar industry predicts an ever-shifting employment situation. Our purpose is to suggest the process management research that we need to undertake now, industry by industry, business by business if we are to have any hope of making ourselves “at home” in the lunar dayspan–nightspan cycle. At stake is the success of lunar industrial diversification, and the competitive market cost of lunar export products.

## **3. Accepting the radiation challenge**

“The Moon is a Harsh Mistress,” blares the title of one of Robert A. Heinlein’s best-known science-fiction novels. Part of that harshness comes from seasonal solar flares of great intensity. Part of it comes from incessant cosmic radiation from all quadrants of the sky. Part of it comes from the Moon plowing through space rivers of meteoritic dust left behind by comets.

All of these dangers call for shielding. The most used lunar resource of all is going to be plain regolith, piled up above habitation and working spaces, directly, or indirectly, that is over hanger-type frames with habitat structures and vehicles safely inside.

We understand the challenge, and the many options. We are prepared to meet the challenge for people in place. But what about for people in transit? A solar flare can hit the

Moon with insufficient warning to allow vehicles more than a few minutes from base to return in time.

We need to give attention to the architecture and building systems to deploy at the least expense, effective wayside flare shelters at regular intervals along roadways. Whether they are lightly or heavily traveled makes a difference not in the spacing and number of shelters, but in how capacious or large such shelters are.

The Moon, like any new frontier will remain hostile and unforgiving only until we have mastered the ways of dealing with the new environment as if by second nature. The need to cover our bodies from the rare but hard to predict solar flare is one we must take seriously. Lunar industry must anticipate this need.

Working out–vac (in the surface vacuum) in spacesuits will be cumbersome and tiring. For routine tasks such as accessing out–vac utility systems or outside storage items needed on a regular basis, it would make sense to place all these items under a shielded unpressurized hanger, shed, or canopy. Then a lightweight pressure suit will do, and that will greatly reduce stress, fatigue, and discomfort. The architectural systems for this everyday out–vac shelter system are the same as those needed in the event of solar flares. We can meet this need now by university–level architectural and engineering competitions, with ease of deployment and of shielding emplacement above the frame all being part of the challenge.

#### **4. First industries first**

It will be a challenge in itself, just to decide which industries to deploy first and just which of many possible paths lunar industrial diversification will take. As in picking a college course, one has to give attention to “prerequisite” courses. Likewise, some industries presuppose others in place beforehand, and in turn enable yet additional industries. Some industries will be viable only if developed side by side, step by step. Now there’s a doctoral thesis for someone!

We make no pretense of being able to sketch such a tree of industrial ancestors (prerequisites) and descendants (dependents) , but would like to start with some notes about what we need to break out of the Outpost Trap. Rather than repeat, we ask the reader to take a second look at MMM # 91 Dec. 1995 p 4. “Start Up Industries on the Moon” – reprinted in MMM Classic #10, a free download pdf file at the sites listed above. Also MMM # 191 DEC. 2005, p 7. First Lunar Manufacturing Industries – available as a Moon Society username/password accessed directory of recent MMM pdf files; [www.moonsociety.org/members/mmm/](http://www.moonsociety.org/members/mmm/)

But, first things first!

- **Regolith bagging and other regolith shielding systems** enhanced
- Prioritization of **fabrication of furnishings and outfitting needs** for inflatable modules
- Using those same industries to **fabricate things for residential quarters**.
- Some **early art and craft media** to make ourselves feel at home with art expressed in native materials

#### **5. One Size does not fit all**

In last month’s installment, MMM #198 page 4, “Modular Transportation” and following, we mentioned that importing modular factory pods and utility pods made sense. That said, a system that works on that scale, say a trailer for a Semi Tractor, may not be the best choice for a smaller installation, nor for a settlement that had grown considerably. We need to base our judgment of system efficiencies and production on scale–dependent guidelines. For a tabletop demonstration, one ISRU device may work fine, but fail utterly on a much larger scale, and vice versa.

#### **6. Attitude is the make–or–break ingredient**

If your way of operating causes a problem, you are unlikely to contribute to a solution. At every stage of human advancement, there have been “shingle”–qualified experts who have said this or that could not be done. A favorite trick in teaching students how to handle such situations is to ask them to jot down all the reasons such and such is impossible to achieve,



and then, after they have done so, give them a second assignment: “Now right down all the reasons why we are going to do it anyway!”

We have to bypass stuck-in-the-present experts and look for “Young Turks” with an open and aggressively adventurous curiosity, determined to find workarounds and new pathways where none were suspected before.

The Moon will be one hard nut to crack. I am sure a human ancestor in Africa a hundred thousand years ago, suddenly transported to the northern coast of Greenland would have thought the same thing. But we did crack that nut. The Inuit and Eskimo take living under such conditions for granted. They handle the challenges that would be life-threatening to us, by second nature.

If we get raised eyebrows along the way, “industrializing the Moon, are you?” let those raised eyebrows encourage us all the more. The epic sweep of the human saga from Africa to continents beyond the shores of their home continent/world runs through our veins. We will do this, because we are humans. And as before, we will become even more human in the doing of it. For the challenge of settling the Moon will bring out new capacities in us, capacities we did not know we had, because we were never challenged before to rise to occasions such as lay before us.

## **VI: The Entrepreneurs**

### **1. Launch vehicles, Modules, Services**

We are used to thinking of “space entrepreneurs” as involved with startup launch companies. Certainly, those are the most visible. Right now, the markets for enterprise involvement are still few, but the pace of new starts is picking up. NASA is one of the forces involved, determined to replace the Shuttle with Commercial launch companies serving the ISS with cargo and personnel transfers. The agency is also trying to find minor roles for private service providers in the return to the Moon and establishment of a small science outpost.

As the International Space Station and possible other orbital facilities grow and multiply, the market for various kinds of enterprises providing logistics services will grow with it.

### **2. Space Tourism**

But the real glamor is in the infant space tourist industry. Here entrepreneurs are involved in providing man-rated launch vehicles, vehicle operation services ([Virgin Galactic](#)), and space destinations ([Bigelow Aerospace](#).) This entrepreneurial area promises to grow continually, with not just orbit in mind, but non-landing loop-the-Moon excursions. Before the first of those, possibly within the next two years, some will start planning how to offer self-contained moon landing sorties.

Some dismiss tourism as a driver. This is a mistake. Discretionary income is rising, and worldwide, tourism is near the top in income-earning sectors. We have believed, that failing a viable Moon-based energy production effort, tourism alone has the capacity to open the Moon. Read MMM #161, Dec. 2002, pp. 4-5 “Tourist Clusters on the Moon.” – available as a Moon Society username/password accessed directory of recent MMM pdf files; [www.moonsociety.org/members/mmm/](http://www.moonsociety.org/members/mmm/)

### **3. Making Money by Laying Foundations**

Stating way back in July, 1988, in MMM #16, we began describing a way of doing business that turns “spin-off” on its head. Instead of NASA doing an expensive crash R&D technology project at the expense of unwilling taxpayers, then, later making the technology available free to enterprises, a would-be entrepreneur looks at the technologies NASA needs (or that we need to go beyond NASA and break out of the Outpost Trap) and brainstorms them for potentially profitable terrestrial applications, creates a business plan, and goes ahead with the needed R&D to be ultimately reimbursed by willing consumers, precisely for those identified terrestrial applications. In the process, a technology needed on the frontier, or a close analog thereof, gets put “on the shelf” free of charge to taxpayers.

We have talked about a number of technologies in need of R&D, and the way to get this done in a timely fashion is not a taxpayer-paid crash program, but by a spin-up enterprise. The options are too many to number, indeed too many to imagine.

So how do we connect potential entrepreneurs in search of a business idea/plan with our laundry list? That is the question, and in a month or two we hope to give you the start of an answer, involving a meta/mega project that will subsume and interrelate all other Moon Society projects and keep us on course on the path to a viable lunar settlement civilization.

## **VII: Moonbase Personnel**

### **The most critical moonbase system to success is the human one**

There have been many Human Factors Research studies done at the two Mars Analog Research Stations to date, but they all suffer from involving short crew stays. Most anyone can put up with anything for two weeks. Studies aboard submarines and at Antarctic stations are more helpful, but still do not mirror conditions we will find on the Moon and Mars.

Many ordinary human activities, are not modeled because they can be postponed. This includes exercise, sport, many kinds of recreational activities, get-away-from-it-all options, indulging artistic abilities, etc.

A more thorough investigative approach should give clues as to which type of modules and facilities, and the activities that they will enable, should be added, and in what priority. At stake is general crew morale, productivity, and safety as well as general health.

That said, NASA's purposes and our purposes are at loggerheads. NASA would indefinitely man a lunar out-post with crews being regularly rotated, barring events unforeseen. Our goal of breaking out of the outpost trap towards settlement, means finding ways to encourage personnel to willingly re-up, i.e. stay for "another tour" without limit, so long as health of the individual and of the crew at large is not an issue. That means providing the kind of perks that

1. Increase morale and improve performance
2. Promote willingness to re-up so as to give the weight allowance for his not-needed replacement to valuable imports of materials and equipment, especially tools and equipment to fabricate and experiment
3. Create a plan for outpost expansion of modules, the facilities they house and activities they enable

### **Providing for a full range of human activities:**

- Getaway "change of scenery" spaces and out-places
- A range of customizing options for personal quarters
- Menu diversity and variety, including fresh salad stuffs and vegetables on occasion
- Schedule breaks (take advantage of the dayspan/nightspace cycle for regular changes of pace such as alternating types of work and recreation)
- Allow fraternization between crew members, without harassment, of course
- Promote expression of artistic and craftsman instincts using local materials and media
- Experiment with lunar sports and other recreational activities. Lunar-unique sports and performing arts will be activities that make crew begin to "feel at home".
- Out-vac sport & recreation on the surface
- An indulgent spa and an exercise gym
- Telecasts to Earth of everything unique and special
- "While you are here" opportunities for excursion exploration and "tourist" experiences and memories

All this both presupposes and prepares for an orderly expansion beyond the original functional and space limits of the original outpost. But that's what we need to do to "breakout of the Outpost Trap."



## Technologies Needed to Break Free

By Peter Kokh

### **VIII: Strategies for Organizations self-tasked with helping make it happen Many have heeded the call**

Several organizations have appeared over the years who have taken upon themselves to help advance the day when space settlement, and lunar settlement in particular, might become a reality. Space Studies Institute, the former L5 Society, the Space Frontier Foundation, Artemis Society International, The Mars Society, The Mars Foundation, The Moon Society, and the National Space Society have pursued these goals on the national and international level. NSS, however, has traditionally limited its set of tools to political, public, and media outreach.

On a smaller scale the Lunar Reclamation Society (publishers of Moon Miners' Manifesto), the Oregon L5 Society, and Calgary Space Workers have done, and still continue to do what they could to lay foundations. Other outfits have come tried for a while, only to disappear.

#### **"Nature abhors a vacuum"**

The premise on the table is that NASA, most probably with international partners, will establish a minimal outpost on the Moon. Several successions of the US Administration and Congress will have to go along with these plans and that makes these plans and announced intentions and commitments highly contingent and "iffy." Further, as individuals and organizations, we will have very limited ability to influence these critical decisions.

But even if all goes as planned, an international lunar outpost will fall far short of establishing a permanent civilian presence on the Moon. Permanence cannot simply be declared. It has to be earned.

#### **Room for the rest of us to rise to the occasion**

What we can do, is to work to see that the needed technologies are in place to enable a "breakout" from any such limited scope outpost, in the direction of resource-using open-ended civilian settlement.

#### **We have looked at several general areas in which a lot of work needs to be done:**

1. Pushing the Teleoperations Envelope
2. Shielding Emplacement Systems
3. Warehousing Systems
4. Modular Biological Life Support Systems
5. Dayspan Power Storage Systems for Nightspan use
6. Modular Architecture & Construction Systems
7. Transportation Systems, to, from, and on the Moon

#### **Tools at our disposal in seeking to further these goals**

- **Brainstorming workshops** – We would gather those at the forefront of experimentation in a given field, ask each to list (a) what we know, and (b) what we don't know.

Combining these surveys, the workshop decides on the most promising areas for collaborative research and experimentation.

- **Design contests** – many things are in need of having design options fleshed out: shielding emplacement systems; shielded but unpressurized canopies and hangers; modular architectural languages; the list is long
- **Engineering competitions** – shielding emplacement systems vie to demonstrate trouble free operation, speed, efficiency, etc.; various options for storing excess dayspan solar power for nightspan usage; interfaces between connected modules, the list is long
- **Talent recruitment** – our collective memberships do boast some people of real expertise and talent, perhaps lost in an abundance of well-intentioned lay persons. We definitely need to recruit talented people in all areas of science and technology, architecture, systems management, biological life support, lunar agriculture, and in many more areas
- **Moonbase analog stations** as equipped settings for demonstrations of candidate technologies. Various types of sites offer advantages for various types of demonstrations: lava sheet areas perhaps with handy lavatubes; any sparsely vegetated pulverized surface area for demonstrations in which the physical attributes of lunar regolith are more relevant than the mineralogical and/or chemical ones: enclosed lighting-controlled environments where dayspan-nightspace operations can be simulated; almost any location where biological life support and food production systems can be demonstrated
- [Lunarpedia.org](http://Lunarpedia.org) – a dedicated lunar-relevant wiki which will attract quality articles about the nature of the Moon, its resources, and the possibilities for integrating the Moon into a Greater Earth-Moon economy, and the possibilities for those involved to make themselves at home.
- **Early astronomical facilities on the Moon** – we can promote design contests, engineering competitions, and the creation of university consortia in support of such a “foot in the door.”
- **Citizen Exploration, aka tourism** – Loop-the-Moon tours are closer than most imagine. Beyond that, the first limited land-and-take-off-again tourist missions could conceivably occur before the deployment of the first agency outpost. Such a development will create a precedent for a truly permanent civilian presence on the Moon not limited to any one surface station.
- **Spin-up Enterprise incubation** – draft business plans entrepreneurs could use to develop needed technologies, now, for their profitable terrestrial applications

### **Marching Orders for whichever organizations choose to step up to the plate**

This becomes the strategy for the Moon Society, and its affiliate and partner organizations. It will come to define “who we are” and “what we do.” What we must do!  
**END THE NEW BEGINNING**

## **IX: A Lunar Analog Station Program can pave the way, if well-focused**

By Peter Kokh, David Dunlop\*, Michael Bakk\*\*

\* Moon Society Director of Project Development

\*\* Captain, Calgary Space Workers who are developing the prototype modular analog outpost

[Our 3rd attempt at unzipping the L.U.N.A. Acronym]

**“Luna Underground Nucleus Analog”**

**“Lunar Underground” – That’s us**, an underground movement! Plus we will model **shielding**, shielding architectures and shielding emplacement options as well as monitor the thermal equilibrium benefits of an “underground” (under a regolith blanket) facility.

**“Nucleus”** – we are modeling not a self-contained unitary module good only for extended science picnics but the kind of modular outpost that could become the nucleus of open-end expansion into a civilian, industrial settlement

**“Analog”** – we aren’t trying to be exact. We need to pick our battles, getting the most bang for the buck.

We had tried twice before to come with an unzipped “Luna” acronym. Most recently, in MMM # 194 April ‘06 we suggested ‘Lunar Underground Network Accelerator.’ In MMM #148 Sept ‘01, “Lunar Utilization & Necessities Analog.” We like the new reading best.

#### **Readings this issue and recent issues of MMM**

page 10, this issue. **Analog Outpost Options continued:**

When what really matters is “moondust behavior,” not “moonscape appearance” – Looking for a “physical” moonscape analog location

page 12, this issue: **More on the Calgary Space Workers Lunar Habitat Project**

MMM #195, May 2006, p 5, **“Goals of a Lunar Analog Station Program,”** Kokh, Dunlop

MMM #198 SEP. 2006, p 7, **“Teleoperating Equipment on the Moon”**

Same issue, p 11. **After Utah, What/Where/How do we follow suite?**

MMM #199, Oct 2006, p 10. **Candidate Lunar Analog Sites**

Same issue, p 12. **Welcome Calgary Space Workers**

#### **A Summary of where we are at in our planning**

As stated in the MMM #195 article cited above, an analysis of research & development demonstration needs shows that the Goals of a Lunar Analog Station are quite different than those of the various Mars Analog Stations:

- We do not need to demonstrate the usefulness of human exploration of the Moon. Apollo did that well.
- We will not be demonstrating microbiological forensic techniques that might prove the Moon once had or might still have living microorganisms – we are all amply convinced by the Apollo and other evidence that the Moon is totally sterile
- Nor do we have to demonstrate geological techniques that might reveal the scope of Mars once much “wetter” past – the evidence that the Moon has always been bone dry is overwhelming.
- We don’t have to model a first visiting crew exploration vehicle. NASA began that with Apollo and will continue that with the lunar outpost program

#### **What’s left for us to do?**

✓ **NASA’s plan was limited from the outset**

✓ **It is vulnerable to budget cutbacks**

NASA’s plan is for a small crew outpost with limited capacities for growth and to support demonstrations of production of various elements and of lunar appropriate building materials. The agency’s plans are very vulnerable to unrelated budgetary pressures, owing to the black hole of conducting an unforeseen war.

#### **Biological Life Support Research has been cut**

Already NASA has discontinued the BioPlex project in Houston and stopped continued funding for the NSCORT program at Purdue University. Both of these programs were aimed at finding practical ways to deploy closed loop life support systems supported by plant growth and food production and waste treatment systems. There is no question in anyone’s mind that a permanent presence, let alone true settlement, can be realistically supported on the Moon without coming very close to “closing the loop.”

This means that it is up to efforts outside NASA to make continued progress in this area. Actually, the NASA plan was so limited from the outset, that it has always been up to us.

**You can't do biological life support in an add-on closet.** Life support cannot be approached as an afterthought. It has to be designed into every module and connecting corridor.

We will be studying the modular habitat prototype being designed and built in Calgary, Alberta, and to be deployed in the Drumheller, Alberta badlands, looking for opportunities to integrate biological life support functions. Biospherics must be approached in a modular fashion, so that as the pressurized interconnected habitat complex grows, the biosphere will grow with it, hand in glove, step by step. If you are designing a limited outpost with expansion as an afterthought, such an architecture will seem irrelevant, or not worth the cost.

### **Shielding cannot be an afterthought**

Many NASA illustrations pay homage to Bob Zubrin's double tuna-can design, become so familiar to all of us as the architecture of the Arctic and Desert Mars Research Stations in Canada and Utah. The high vertical profile makes shielding difficult. Zubrin seems to dismiss radiation shielding as unnecessary. But if we are going to move beyond short tours of duty towards real permanence, we have to rely on more than Release Statements that do not hold NASA responsible for radiation damage.

Unaddressed are the major thermal equilibrium benefits of shielding. It pays to design an outpost in a "ranch style" low profile format to make deployment of regolith shielding easier. Shielding can be deployed directly as loose regolith, or as bagged or sintered regolith (blocks) for easy removal should access to the hull or a need for expansion make it necessary. We need to experiment with teleoperated shielding deployment systems, so that a landed but unoccupied outpost can be pre-shielded and ready for occupancy by the first crew. We can demonstrate a variety of such systems.

### **Modular Architecture, Shielding, and the Media**

Granted, the Zubrin double tuna can (DTC) design has been a big hit with the press. It looks like the other-worldly mechanical "visitor" that it is. On the other hand, it does not look like "module one" of a future settlement, and that is the concept that what we want the public and the media to grasp. We must sell modularity. On the surface, that will be an easy task. But if we use reconditioned travel trailers and other adapted but identifiable terrestrial artifacts, that appearance may detract and distract from the lesson we are trying to get across.

However, if we shield the complex with simulated regolith, sand bags, or bags of mulch, whichever is more practical, we'll get our lesson across. A shielded modular complex will look much more serious than the DTC. The idea that we are planning to stay on the Moon, not just explore it and go back home, will be clear. We can make show how the shielding blanket on the Moon will perform the same services for us as does our atmosphere blanket. That we can make ourselves at home on what looks like an inhospitable world will begin to sink in. Daydreams of being stationed in a livable lunar outpost will start to look more romantic than being confined to a DTC on Mars.

### **Resource use should not be an afterthought**

The well-advertised NASA In Situ [on location] Resource Use demonstration of oxygen production is still on the Lunar Outpost manifest. But by deciding that lunar oxygen would not be used for the lunar ascent vehicles, NASA effectively put it on the budgetary chopping block.

Lunans will not live, let alone thrive, by Oxygen alone!

A lunar analog research station in basaltic terrain could get involved in cast basalt use demonstrations. Cast basalt tiles and abrasion resistant materials handling components are now being produced in several locations. If there is anything that is priority #1 it is to test regolith handling systems, and if we need cast basalt products for that, that fact would but cast basalt demonstrations ahead of everything else, perhaps even ahead of oxygen, as all other ISRU experiments will depend on regolith handling. Cast basalt products can replace many original outfitting items in the habitat module complex: flooring: table, desk, counter, cabinet tops, wall tiles, decorative items and objets d'art.

Other building materials to experiment with are glass–glass composites (currently just one ice–cube sized laboratory sample), steamed fiberglass cements, fiber–glass–sulfur composites, sintered regolith products, sintered iron fines products, sintered regolith products. The first goal will be to be able to demonstrate the feasibility of local (on the Moon) outfitting of inflatable expansion modules. Demonstration of the production of pressurizable modules from simulated lunar building and manufacturing materials would come next.

Experimentation with lunar sourceable metal alloys, as critical as it is, is best done elsewhere, because of project complexity and thermal conditions, and the expertise needed. In all these ISRU experiments, we must keep in mind that laboratory scale experiments, however successful, do not prove that production–scale operations are feasible. Chemical engineers will be much more help–full than chemists, for example. Laboratory scale experiments done elsewhere can possibly be demonstrated on a larger scale at analog facilities.

### **Power Production & Storage**

NASA and many lunar enthusiasts are hellbent on setting up shop at the lunar south pole. To quote lunar planetary scientist Paul Spudis,

“Although polar ice is important, it is not a requirement to successfully live and work on the Moon. The poles of Moon are primarily attractive due to the near–permanent sunlight found in several areas. Such lighting is significant from two perspectives. First, it provides a constant source of clean power and allows humans to live on the Moon without having to survive the two–week–long lunar night experienced on the equator and at mid–latitudes. Second, because these areas are illuminated by the Sun at grazing angles of incidence, the surface never gets very hot or very cold. Sunlit areas near the poles are a benign thermal environment, with an estimated temperature of about  $-50^{\circ} \pm 10^{\circ}\text{C}$ .” –

<http://ww.thespacereview.com/article/740/2>

Now if you are younger than fifty, the expression “Kilroy was here,” may mean nothing. This was a WW II (and perhaps older) way of “tagging” a place to say that a Yankee (an American) had been there. Now if all that you need to die happy is to know that we put up a “Kilroy was here” outpost at the Moon’s south pole, than Spudis’ vision will thrill you to the core.

But if by “lunar settlement” you mean a global presence of humanity on the Moon, then the lunar polar “gesture” (which is all it is) will be but “a tagging event.” Avoiding the Nightspan Power Problem and the Dayspan Heat Problem is exactly what we must not do!

As NASA has chosen not to bite this bullet, demonstrating various ways that enough excess lunar solar dayspan power can be stored to get us productively through the nightspan is a priority task for Lunar Analog Stations. That said, simulating the 14 day 18 hour long dayspan and same length nightspan will be much easier to do inside a closable structure such as a large aircraft hanger or high–ceiling warehouse than anywhere outdoors. For this kind of experimentation and demonstration the geological and/or physical characteristics of the host terrain will be irrelevant.

Power storage options include storing waste water at a usable head height, flywheels, fuel cells, magma pools, and other devices. Yes, a nuke would do, but we think it is important to demonstrate any other non–nuclear “backup” options that would do the trick, and which would be easier to scale up or down to the power requirements of a growing lunar beachhead.

The other half of the equation is demonstration of how well various types of lunar outpost operations can be managed sequentially to take care of the bulk of energy–intensive operations during the dayspan, and the bulk of labor–intensive energy–light operations during the nightspan. Such a regular change–of–pace rhythm is bound to become a welcome mainstay of lunar culture.

### **Ergonomics Demonstrations**

The Mars Society missed an obvious opportunity for an ergonomics layout study, by outfitting the interior of its second habitat, the Mars Desert Research Station, with essentially



the same floor plans, upper and lower, as in the Arctic station which was built first. Of course, there were time and money benefits to taking a bite on the ergonomics opportunity.

The independent-minded European Mars Society will be designing the interior of the EuroMars with a clean slate. They are happily immune to the expected criticism. This unit will be just a tad taller, by just enough to squeeze in a third floor. They will be incorporating more opportunities for customization of personal quarters, euphemistically called “staterooms” as well as morale boosting perks like a spa tub, and exercise area. The objection that pioneers should feel privileged to “rough it” just doesn’t cut it. High morale translates to productivity and safety, and those are far more important considerations than penny pinching economy. One must keep in mind that the Mars explorers will be away from home for two or three years, factoring in the long travel times to and fro.

A modular outpost gives much more opportunity to vary living and working arrangements and their mutual proximity or isolation. A modular outpost, particularly a “practice” one, can have its layout plan “shuffled and reshuffled” until the happiest disposition is found. A consideration, one that does not easily arise in the Mars Hab instances, is finding the best vectors for expansion of the various kinds of facilities: residential, energy generation, workshop, laboratory, fabrication shop, greenhouses, exercise and recreation facilities, and what-ever other modular facilities may be needed to “break out of the Outpost Trap.” Developing a site plan with options for expansion must be part of the site selection process.

A mix of hard body and inflatable modules will also yield valuable lessons. The option of adding new modules fabricated out of simulated lunar-processed building materials such as glass composites or fiberglass reinforced concrete is also attractive.

#### **Lunar Analog Outposts will be innovative**

It may seem to the casual observer in the public or the media that the exercises at the two operational Mars Habs are getting repetitious. Until you take a close look, all the geology experiments, the biology experiments, the GreenHab experiments, and the human factors studies seem to produce nothing new. Take it from one who has been on two MDRS crews: that is definitely not the case. New things are being learned crew after crew, and I remain a staunch supporter of the Mars Analog program. But the illusion or repetition dogs the program.

Next year, there will be a 4-month long exercise by one crew at the Arctic outpost on Devon Island. That will definitely test the reliability of utility systems, at a location that is logistically quite isolated, as well as be a superlative opportunity for human factors studies. Now if the Mars Society would embrace the projects to the Mars Home Foundation which wished to build a demonstrator Martian Village out of materials available on Mars, that would be really helpful.

In contrast, the Lunar Analog Station programs will have no shortage of new things to do and try and test. The clear sign of progress will work to keep the media, and the public interested, as well as to educate them on the possibilities of human settlers making themselves permanently at home on the Moon.

#### **Lunar Analog Outposts and Tourism**

When the Moon Society was founded in July 2000, the flagship project announced to celebrate the society’s birth was Project LETO [Lunar Exploration & Tourist Organization] conceived of as both a tourist facility and as a research station. On first glance, this would seem to be a marriage made in heaven. But having four weeks of experience at MDRS in Utah, I’m convinced that research is best done without the visual or actual interference of curious onlookers. Now in the 2005–2006 field season we experimented with first one web cam then as with as many as six. This works well, and does not disturb research activities.

What does seem most important, even to the point of being sacred, is to preserve the illusion that you are on Mars (or, in our case, on the Moon) as the illusion helps one take the experimentation and/or exercise seriously enough to ensure superior results. In short, it does not disturb research if visitors or tourists can watch so long as they are out of sight of the researchers.

One way to keep the required separation is the use of web-cams. What about an analog of a duck-blind? That might work for outdoor activities, but without a great number of such blinds, we couldn't ensure visitors that there would be anything worth observing on a regular basis. Web cams or remote TV cameras would seem to be the better answer. Actual supervised "do not touch anything period!" tours could be conducted when the facility was not occupied.

At MDRS, media visits are allowed, but scheduled by program headquarters to minimize interference with MDRS activities. Nonetheless, interfere they do.

Visitor access is important. We will have our faithful followers and enthusiasts who will want the high of seeing this glimpse of the future for themselves. What we can't do is make the analog outpost a zoo exhibit! or create conditions where the crews feel that they are zoo animals. But growing our constituency is of primary importance as well. So how we can best satisfy the needs of both the various crews and the faithful/curious without shortchanging either is an area that deserves much fore-thought and should be part of the original site plan.

### **The commercial connection**

Whenever or wherever the brand or supplier of any needed equipment is not crucial, the opportunity to have the equipment donated "by the official refrigeration supplier to the Moon Society Lunar Analog Outpost" etc. (for sake of example) should not be passed over lightly. We will always have less money than we need. And when performance or specifications are crucial, all the more reason, for advertising punch to approach a manufacturer or distributor for product donation or free lease.

We have talked many times about the "spin-up" paradigm, much more powerful than the "spin-off" system in place for decades. In spin-up, an entrepreneur develops a technology or product which happens to be needed on the frontier, precisely for the potential "here and now profits" from any terrestrial applications. As we succeed in encouraging entrepreneurs to take this route, they can test and showcase their products at an analog moonbase location, as an effective advertising ploy. The donation of a model, when it can be integrated into the analog moonbase operations, would be a big plus.

We may be the small guys in town, but we have the bigger dreams, the more powerful dreams, the only dreams that make sense in the long run. There may be several analog lunar station operations. Between us, we can leverage our way to reality. <MMM>

## **MMM #201 – December 2006**

### **First Moonbase:**

#### **The Future of Human Presence on the Moon**

By Peter Kokh [kokhmmm@aol.com](mailto:kokhmmm@aol.com)

#### **Beginnings**

If all goes as planned, U.S. budget crises notwithstanding, mankind's first outpost on the Moon will start to become real around 2020, a historic event, that were it not for politics, might have happened decades earlier.

The vision outlined in **The Moon: Resources, Future Development and Settlement**, by David Schunk, Burton Sharpe, Connie Cooper and Madhu Thangavelu is a bold one, showing how we could set up our first outpost so that it would become the nucleus from which human presence would spread across the face of the Moon.

NASA itself has such a vision, but the agency can only do what it is authorized to do. If the history of the International Space Station offers clues, NASA's official goal, which only includes setting up a first limited out-post as a training ground for manned Mars exploration and nothing more, will be under increasing budgetary pressures to slim down into something with no potential for growth at all. The intended crew size, the planned physical plant, and the

capabilities that are supported, will all be tempting “fat” for budget cutters who cannot see, or appreciate, the possibilities beyond. This is the risk of publicly supported endeavors in space. It is difficult to get political leaders, and the public itself, to look beyond very near future goals. The chances that our first outpost will be born sterile cannot be dismissed.

But if private enterprise is involved and ready to take over when and where NASA’s hands are tied, there could be a bright future for us on the Moon. Much of that promise may involve finding practical ways to leverage lunar resources to alleviate Earth’s two most stubborn and intertwined problems: generating abundant clean power, and reversing the destructive pressures of human civilization on Earth’s environmental heritage.

### **Cradlebreak: early lunar building materials**

The Moon has enormous resources on which to build a technological civilization. But first things first. How can we break out of a first limited-vision outpost? A humble start can be made by demonstrating the easier, simpler ways to start lessening the outpost’s heavy dependence on Earth. Oxygen production comes first. Close behind is hydrogen harvesting, whether from lunar polar ice deposits or from solar wind gas particles found in the loose regolith blanket everywhere on the Moon.

If we have access to basalt soils in the frozen lava floods of the maria, we can cast this material into many useful products. Not the least of those are pipes, sluices, and other components of regolith handling systems: cast basalt is abrasion-resistant. If we expand the outpost with inflatable modules shipped from Earth at significant savings in weight per usable volume over hard-hull modules, we can use cast basalt products, including floor tiles and tabletops to help outfit these elbowroom spaces. We can learn from a thriving cast basalt industry on Earth.

Experiments done on Earth with lunar simulant, of similar chemical and physical composition to lunar regolith, then repeated with precious Apollo moon dust samples, give us confidence that concrete and glass composites will be very important in any future construction and manufacturing activity on the Moon. We could make additional pressurizable modules from fiberglass reinforced concrete or glass composites. We can make spars for space frames and many other products out of these composites as well. The Moon’s abundant silicon will allow us to make inexpensive solar panels for generating power. Production of usable metal alloys will come later. The Moon is rich in the four “engineering metals:” iron (steel), aluminum, titanium, and magnesium.

### **An Industrial Diversification Strategy with maximum potential for cutting dependence on Earth imports .**

The name of the game is Industrial “MUS/CLE.” If we concentrate on producing on the Moon things that are **Massive**, yet **Simple**, or small but needed in great numbers (**Unitary**) so as to provide the major combined tonnage of our domestic needs, we will make significant progress towards lessening the total tonnage of items needed from Earth to support the expansion effort.

Until we can learn to make them ourselves, we continue to import the **Complex**, **Lightweight**, and **Electronic** items we also need, but which together mass to much less. It would be very helpful to the success of such a strategy, to design everything needed on the Moon as a pair of subassemblies, the **MUS** assembly to be manufactured locally, and the **CLE** assembly to be manufactured and shipped from Earth, both being mated on the Moon.

Simple examples are a TV set: works manufactured on Earth, cabinet on the Moon; a metal lathe built on Earth, its heavy table mount manufactured on the Moon; steel pipe and conduit on the Moon, all the fittings and connectors from Earth. You get the idea.

As the population of pioneers and settlers grows, and our industrial capacity becomes more sophisticated and diversified, we can assume self-manufacturing of many of those items as well. Making clear and steady progress in assuming an every greater share of self-manufacturing physical needs is essential if we are going to encourage both continued governmental support and attract every greater participation by private enterprise.

## **Paying for the things we must import**

Seeing that Earth seems rather self-sufficient, and products from the Moon would be expensive, many writers have concentrated on trying to identify “zero mass products” such as energy, to provide the lunar settlements with export earnings. The need for exports is indeed vital. As long as the settlement effort must still be subsidized from Earth, there will always be the risk of unrelated budgetary pressures on Earth fueling support for those who would pull the plug on lunar operations.

Thus it is vital that settlers develop products for export to help them pay for what they must still import. Only when we reach import-export parity, will the lunar settlement have earned “permanence.” Permanence can’t be simply declared. Tagging NASA’s first moon base as “a permanent presence on the Moon” is in itself just so much empty bravado. If we do not begin developing and using lunar resources seriously and aggressively, the effort will fail of its own costly weight.

Now here is the point where many will balk. Yes, there are grandiose plans to use lunar resources to build giant solar power satellites in geosynchronous orbit about the Earth, or to build giant solar farms on both the east and west limbs of the Moon to beam power directly to Earth, and/or to harvest precious Helium-3 from the lunar topsoil or regolith blanket, a gift of the solar wind buffeting the Moon incessantly for billions of years, the ideal fuel for nuclear fusion plants. But none of these schemes will materialize right away. Meanwhile what do we do? Cannot anything the Moon might manufacture to ship to Earth be made less expensively here at home? No!.

But that does not matter. Earth itself is not the market. Developing alongside of an upstart settlement on the Moon will be tourist facilities in Earth orbit. And that is something the lunar settlement effort can support. Anything future Lunan pioneers can make for themselves, no matter how unsophisticated in comparison with the vast variety of terrestrially produced alternatives, can be shipped to low Earth orbit at a fraction of the cost that functionally similar products made on Earth can be shipped up to orbit. It is not the distance that matters, but the depth of the gravity well that must be climbed. It will take one twentieth of the fuel cost to ship a set of table and chairs, a bed frame, interior wall components, floor tiles, even water and food, from the Moon, 240,000 miles away, than from Earth’s surface, 150 miles below.

Thus, in the near term, the future of Lunar Settlement will be closely tied to the development of tourist facilities, hotels, casinos, gyms, etc. in orbit. This sort of development will start to bloom about the same time as a lunar settlement effort starts to break out of an initial limited moonbase egg. But the linkage will become visible much earlier: it is very likely, that the first space tourist will loop-the-Moon, without landing, before the first astronaut since Apollo 17 in 1972 sets foot on the Moon. The Russians say that they can provide such a tourist experience, skimming low over the Moon’s mysterious farside, in just two years after someone plunks down \$100 million. That will indeed happen, and it will create a benchmark that others will want to follow, inevitably brining the price down for a ride to an orbiting resort.

## **The Moon from a Settler’s Point of View**

Magnificent Desolation? Yes. Harsh and unforgiving? That too. Alien and hostile? Of course! It has always been so from the time our ancestors on the plains of East Africa started pushing ever further into unfamiliar lands: the lush, dense jungles, the hot dry deserts, waters too wide to swim, high mountain ranges, and eventually, the arctic tundra. Judged by the pool of past experience, each new frontier was hostile, unforgiving, and fraught with mortal dangers, until we settled it anyway.

Once we learned how to use unfamiliar resources in place of those left behind, once we learned how to cope with any new dangers, as if by “second nature,” then the new frontier becomes as much home as places we left behind. Anyone raised in a tropical rain forest, suddenly transported to Alaska’s north slopes, might soon perish, unable to cope. The Eskimo never gives it a second thought. How to cope with ice, cold, the arctic wildlife, the absence of lush plant life, has become second nature.

And future Lunans will reach that point as well. Yes, there is sure suffocation outside the airlock. Yes, the sun shines hot and relentlessly with no relief from clouds for two weeks on end. Yes, the Sun stays “set” for two weeks at a time while surface temperatures plunge. Yes, the moon dust insinuates itself everywhere. The litany goes on and on. Lunans will learn to take it all in stride. How to take due precautions for each of these potential fatal conditions will have become culturally ingrained 2nd nature. The Moon will become a promised land to Lunans.

### **Making ourselves at Home**

Even in the first lunar outpost, crew members could bring rock inside the habitat as adornment in itself, or perhaps carve one into an artifact. An early cast basalt industry, early metal alloys industries, early lunar farming, will all supply materials out of which to create things to personalize private and common spaces alike. Learning to do arts and crafts on the Moon may seem useless and irrelevant to some, but it will be the first humble start of learning to make the Moon “home.” And so it has been on every frontier humans have settled.

We will also learn to schedule our activities and recreation in tune with the Moon’s own rhythms. We’ll do the more energy-intensive things during dayspan, the more energy-light, manpower-intensive things saved for nightspan. With no real seasons, the monthly dayspan-nightspan rhythm will dominate. The pioneers may bring some holidays with them, but will originate other festivities and both monthly and annual celebrations.

Getting used to lunar gravity will also help the pioneers settle in. They will quickly abandon trying to adapt familiar terrestrial sports, which can only be caricatures of the games of Earth. Instead, they will invent new sports that play to the 1/6th gravity and traction, while momentum and impact remain universally standard. Alongside the development of lunar sports will be forms of dance. Can you imagine how ethereal a performance of Swan Lake would be on the Moon? How many loops could an ice-skater do before finally landing on the ice? .

### **But they have to live underground, for heaven’s sake! .**

On Earth, our atmosphere serves as a blanket which protects us from the vagaries of cosmic weather: cosmic rays, solar flares, micrometeorite storms. If our atmosphere were to “freeze out” it would cover the Earth with a blanket of nitrogen and oxygen snow about 15 feet thick, and still provide the same protections.

On the Moon, eons of micrometeorite bombardment have pulverized the surface and continue to garden it into a blanket of dust and rock bits 10–50 feet thick. Tucking our pressurized outpost under such a blanket, will provide the same protection, along with insulation from the thermal extremes of dayspan and nightspan.

Will our outposts look like somewhat orderly mazes of molehills? To some extent, perhaps; but the important thing is that we do not have to live as moles. We have ways to bring the sunshine and the views down under the blanket with us. In the spring of 1985, I had the opportunity to tour a very unique Earth-sheltered home 20–some miles northwest of Milwaukee where I live. Unlike typical earth-sheltered homes of the period, Terra Lux (EarthLight) did not have a glass wall southern exposure. Instead, large mirror faceted cowls followed the sun across the sky and poured sunlight inside via mirror-tiled yard wide tubes through an eight-foot thick soil overburden. Periscopic picture windows provided beautiful views of the Kettle Moraine countryside all around. I had never been in a house so open to the outdoors, so filled with sunlight, as this underground one. At once I thought of lunar pioneers, and how they could make themselves quite cozy amidst their forbid-ding, unforgiving magnificent desolation. The point: yes, the Moon is a place very alien to our everyday experience. Nonetheless, human ingenuity will find a way to make it “home.”

### **What about us outdoorsmen?**

While Lunans will find plenty to do within their pressurized homes, workplaces, and commons areas, many will miss the pleasures of outdoors life on Earth: fishing, swimming, hunting, boating, flying, hiking and mountain climbing and caving. The list goes on and on.

Yet some of these pleasures we may be able to recreate indoors, fishing in trout streams, for example. We will want an abundant supply of water, and waste water in the process

of being purified can provide small waterfalls and fountains, even trout streams for fishing and boating. In large high ceiling enclosures, humans may finally be able to fly with artificial wings, as Icarus tried to do.

Out-vac, out on the vacuum washed surface, it will be more of a challenge. Present space suits are too cumbersome, too clumsy. We need suits that offer more freedom of motion, that tire us less easily. Then out-vac hiking, motor-biking, mountain climbing, and caving in lavatubes will become practical. Out-vac sporting events, rallies, races, and games will follow. As we learn to take the Moon's conditions for granted, and to "play to them," we'll invent sporting activities that suit the environment.

### **Agriculture and minibiospheres**

The idea of going to the Moon with sterile tin cans and a life-support system tucked in a closet with a few token house plants thrown in for good luck is absurd. As it happens, NASA has abandoned "Advanced Life Support." Instead we have to approach creation of living space on the Moon as a mating of modular architecture with "modular biospherics." Every pressurized module should have a biosphere component, so the two, living space, and life in that space, grow apace, hand in hand. The clues are not in the organic chemistry labs but in the many down to earth "back to earth" experiments thriving on Earth as we speak. Earth life must host us on the Moon even as it does on Earth, not vice versa. Lunar settlements will be "green" to the core. And we will feel at home.

### **One settlement, a world "doth not make"**

The Moon's resources are not homogeneously situated. A site handy to polar ice reserves will not be near mare basalts, nor iron and titanium rich ilmenite, nor vast underground caves formed long ago by running lava. As the lunar economy expands, we will need to establish settlements in a number of differently advantaged areas. And that will make the Moon a real "world." Lunans will be able to travel elsewhere, get away from it all, experience cultural, artistic, archeological, and climate variations. Even as an outpost cannot be "declared" permanent, neither can a solitary settlement. No matter where we choose to set up shop first, we need a global vision. The authors have this vision, and their brilliant concept of a lunar railroad network illustrates that well.

### **Getting through the Nightspan**

To many people spoiled by abundant energy "on demand," the need to store up enough energy during the two week long dayspan to allow the outpost to not just survive the nightspan, but to remain productive is daunting. Yet all of human progress is built on utilizing various forms of power storage, starting with firewood. Even in nature, the spread and survival of species has turned on this point, from bear fat to squirreling away nuts. The problem is one of attitude. Those with the right attitude will find a way, many ways in fact. The same goes for managing the thermal differences between lunar high noon and predawn. Since we first began to move out of our African home world to settle the planets of Eurasia and the Americas, we have tackled harder problems. Those not intimidated by the challenge will lead the way.

### **The pattern emerges**

Lunan pioneers will make progress in all these areas together: providing the bulk of their material needs by mastering lunar resources; becoming ever more at home through lunar-appropriate arts, crafts, sports, and hobbies; creating a uniquely Lunan culture. This process must start immediately. The first outpost should be designed to encourage, not discourage experimentation by those with the urge to create and fabricate with local materials. Things shipped from Earth should be designed and manufactured in MUS/CLE fashion, so that their simpler and more massive components, made on Earth can be replaced with parts made on the Moon, freeing up the original parts for reuse. Parts made here of elements hard to produce on the Moon, like copper or thermoplastics, will help spur infant lunar industry at a quicker pace.

### **The Necessary Gamble**

It is predictable that NASA, however free the life styles of its individual employees, will continue to take a conservative stance on fraternization between outpost personnel. It is predictable that there will be an absolute ban on pregnancies. Yet, this is something that

cannot be conveniently postponed. The only way to know for sure if infants born on the Moon will turn out to be healthy, is to see how the second native born generation turns out. Will they be fertile? Experiments with animals with much shorter life cycles will give us debatable clues. There is but one way to find out for sure. Do it! Take the plunge.

Official policy may be quite strict and allow no exceptions. But then individuals will take matters into their own hands. Confidence in this outcome will grow, if there are for-profit commercial outposts on the Moon.

As long as we play the “outpost game,” and that is what it is, of rotating crews with short tours of duty, as long as we avoid allowing people to choose to live out their lives on the Moon, raising families, as nature dictates, we will not see the rise of a lunar civilization, nor real use of lunar resources to help solve Earth’s stubborn energy and environmental needs in sustainable fashion. Human choices must be taken out of the hands of politicians and administrators afraid of conservative opinion. Nations may build outposts, but only people pursuing personal and economic goals can give us settlement. If history is any guide, that is exactly what will happen.

Antarctic outposts are a dead-end paradigms no real use of local resources, no economic activity, no real society. For the Moon, we see instead, a real human frontier in which an initial small outpost will seed a self-supporting frontier of hundreds of thousands of pioneers in a number of settlements. Many of these Lunans will be native born, others fresh recruits from Earth seeking the promise of starting over, starting fresh, getting in on the bottom floor. Throughout history, those doing well stayed put. Frontiers have always been pioneered by the talented but “second best” seeking a more open future.

The Moon will become a human world. <MMM>

[Reprinted with permission, from **The Moon: Resources, Future Development and Settlement** by David Schunk, Burton Sharpe, Connie Cooper and Madhu Thangavelu, in which it appeared as Appendix T.]

M O D U L A R

B I O S P H E R I C S

## Making the most of pressurized pedestrian & vehicular corridors: ”Living Wall Systems”

By Peter Kokh

“A **living wall** is a vertical garden. Plants are rooted in compartments between two sheets of fibrous material anchored to a wall. Water trickles down between the sheets and feeds moss, vines and other plants. Bacteria on the roots of the plants metabolize air impurities such as volatile organic compounds.” [http://en.wikipedia.org/wiki/Living\\_wall](http://en.wikipedia.org/wiki/Living_wall)

While this is the definition in the most technical sense, experimenters have made living walls in which plants are in pots anchored to a wall in a staggered pattern. They have also found other ways to keep them properly watered, fertilized, and to recycle the drainage water. Illustration 2 below is an example of the first approach, illustration 3 below the latter.

In a modular outpost, there will be connecting tubular passageways for pedestrians and small carts. Their curved walls offer an opportunity to increase the overall biosphere mass of a lunar outpost (real or analog) by integrating a living wall feature along one side, for the whole length of (each) hallway. This will be in addition to the biomass contributed in any Greenhouse modules and any in the habitat and activity modules themselves.



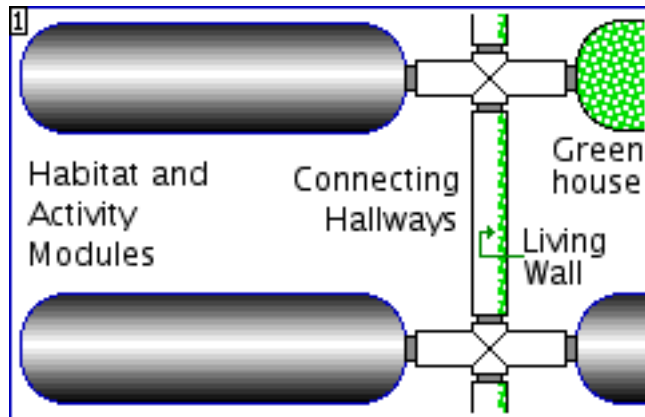

In a larger settlement, pressurized roads could have living walls to each side, and, down the middle, to separate traffic flowing in opposite directions, boulevard style. If we continue to think in terms of floor space, then we will be put in competition with the plants we depend on – not a prescription for success. But plant areas can make use of otherwise empty wall space. “Waste no opportunity to include more plant life, want not for your next breath” to paraphrase an old saying.

If we are talking about an open-ended installation (again, either on the Moon or at an analog research site) by adopting a policy that no wall should be idle, we guarantee that the modular outpost grows, a modular biosphere grows with it, neither outstripping the other. Now can there possibly be a better arrangement?

Yet so far all biosphere experiments seem to be of set size, not designed to grow in modular fashion. The non-modular set-size approach tends to be an effective predictor that the installation will have no future.

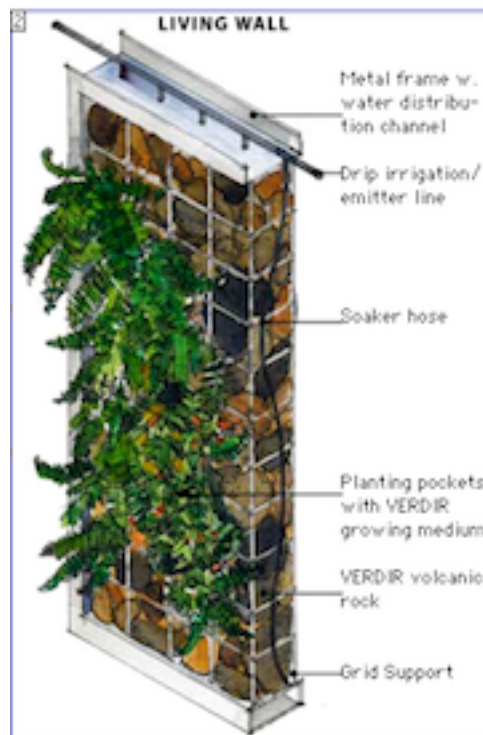

from [www.verdirsystems.com/html/living-walls.html](http://www.verdirsystems.com/html/living-walls.html)

The above shows a technical approach.

Dr. B. C. Wolverton, doing the research for NASA, identified a dozen common house

plants easily available that cleansed the air, including: gerbera daisy, bamboo palm, spider plant, marginata, mass cane, spathiphyllum, Janet Craig, and English Ivy – published in the pamphlet “Plants for Life: Living Plants Vital In Filtering Contaminated Air”– a NASA pamphlet published more than fifteen years ago.

Now Dr. Wolverton has published a much more comprehensive treatment in the book, “**How to Grow Fresh Air: 50 Houseplants that Purify Your Home or Office**”

Penguin Books ISBN 0.14.02.6242.1.

Many Living Wall installations use a system of staggered planters and integrated water features to accomplish the same ends in a more natural and beautiful fashion.

**Plants to choose from:** There is a wide variety of plants that provide lush green foliage while cleansing the air of toxins (to prevent “sick-building syndrome”) and increase the amount of oxygen, maintaining a fresh, clean atmosphere inside.



**Left above:** Living Wall installation, Baltimore, MD. This 110 sq ft (10 sq m) wall filters all the air for its 7,500 sq. ft. office building. Notice the ornamental character of some plants chosen

**Right above:** Cross-section of a hallway corridor in a modular Lunar Analog Research Station – or in an actual Lunar Outpost

**Decorative Options:** It is easy to work in rocks and planters, sculptures and other objects into a living wall system. These can be design accessories or fully functional parts of the plant holding and water irrigation systems.

**Living Walls as Graywater Purifiers**

[www.holon.se/folke/projects/openliw/openlev\\_en.shtml](http://www.holon.se/folke/projects/openliw/openlev_en.shtml)

“By growing plants in a porous wall [a special adaptation of the Living Wall concept, read on ], you get both an efficient space use by vertical plant growing and purification of the percolating water, which can be grey-water.” (Graywater is water from sinks, tubs, and showers, and previously treated blackwater from toilets.)

“The hollow parts of the stones are filled with inert material, like gravel, LECA-pebbles, perlite or vermiculite. The stones are placed so the water will percolate in zigzag through the wall. Bacterials in the porous material break down organic pollutants. The water trickling down through the wall will nourish the plants at the same time as it will be purified. The plant roots will grow into the inert material and extract nutrients from the water. Over the pebbles, a bacterial film will grow. After consuming organic material they release the nutrients in the percolating water. The plants will take up the nutrients and subsidize the bacteria with sugar from their photosynthesis.

“By this, you get both vertical growing & grey-water purification. Therefore, the efficiency of the purification is dependent on the amount of solar radiation reaching the plants in the wall.”

### **Air Circulation Systems**

“Active walls” are also integrated into a building's air circulation system. Fans blow air through the wall and then recirculate the refreshed air throughout a building. These indoor living walls help prevent and/or cure what is known as “sick building syndrome” by increasing air oxygen levels.

### **Integrating Water Features and Fish**

Some Living Walls integrate fish ponds at the foot of the wall as part of the system where trickling water collects before it is pumped back up to the top of the wall.' The foliage purifies the graywater, digesting the dissolved nutrients. Thus a living wall can be an integral part of water purification and reuse, not just fresh air.

A living Wall is something to be designed to suit taste as well as to serve function. In a modular (analog or real) lunar outpost, each hallway could boast its own design, creating a more interesting working an living environment as well as a fresher, cleaner, healthier one.

You can go high-tech, but this is not necessary, and the cost-benefit ratios of a high-tech approach are probably not great. Low tech is always better if it works.

### **Using all Opportunities to increase biomass**

We tend to make the mistake of describing living space volume in terms of square footage of floor space only, neglecting the opportunity walls provide. Counting all surfaces is the secret of packing a bigger biosphere into a smaller space: using walls, and even ceilings!

It is important, if we are going to bring the biosphere truly inside, to build our environment with mold-resistant surfaces. This means giving careful consideration to materials and surface coatings, as well as due humidity control and ventilation.

### **Sunshine, or its equivalent**

Proper light must be brought in by light pipes, clerestories, or grow-lamps: a separate, related topic.

### **Purposes of a System of Living Walls in an Outpost**

- Purify and freshen air; purify graywater
- Provide lush greenery, color, interest
- Provide herbs, spices, berries, etc. and last, but not least, to
- Psychologically “re-encradle” crews in a mini-biosphere

## **MMM #202 – February 2007**

M O D U L A R

B I O S P H E R I C S

### **Middoor Public Spaces as ideal Opportunities for added vegetation and even “urban” wildlife**

“Middoors” MMM speak for pressurized common spaces such as pedestrian passages, streets, parks, and plazas where temperatures could be allowed to fluctuate between cool predawn lows and warm pre-sunset highs; as opposed to “indoor spaces” in private residences and in commercial, educational, office and Other fully climate-controlled areas of activity.

In the December 2006 issue of MMM # 201, we described Living Wall systems which take advantage of frequently unused or underutilized wall-hugging spaces for growing plants that will help cleanse indoor air of carbon dioxide and other airborne pollutants, boost fresh oxygen levels, and in the process create water features that could harbor fish. In this installment of our “Modular Biospherics” series, we take up the opportunities for additional

vegetation in other common spaces within the outpost or settlement.

### **Public Squares, Plazas, Marketplaces, etc.**

These will be enlarged nodes or pressurized intersections where three or more pedestrian passages and/or pressurized roads restricted to bicycles and electric vehicles come together. At least some of these intersection nodes should be enlarged to provide extra ground space for plants of various kinds, walkways, park benches, water features, etc. They should offer two more perks: higher vaulted ceilings, and over-illumination.

Higher ceilings offer welcome eye relief. The human eye has evolved to take in the sky, not just a horizon-hugging layer of vertical space. Living inside the confined vertically challenged spaces of an extensive modular maze will leave much to be desired. Yet, on the Moon at least, this may be necessary. The nitrogen needed as a neutral oxygen buffering component of breathable air will be in short supply. There are two ways to conserve the amount of nitrogen needed, and we will need to make use of both!

- Use one half normal air pressure, with all the hit being taken by nitrogen. That means, instead of a 79:21 nitrogen-oxygen mix, we may be using a 58:42 mix, with the actual partial pressure of oxygen unchanged. An important beneficial effect of using an 0.5 ATM pressure is that this will greatly reduce the propensity to spring leaks.
- Keep ceiling heights, and thus total volume of air needed, on the low side. I wouldn't suggest lower than 9 feet. That may seem generous, but we would be allowing for the progeny of the first settler generation to grow taller than their parents, given the low gravity.

But here and there it will be advisable, for the sake of morale, to have more spacious places in which to congregate and relax. Outdoor full sunlight level lighting and notably higher ceilings, painted a matte sky blue and brightly uplit, will subconsciously lift spirits and supply a well-needed boost. People will enjoy being there!

We have ample experience creating little urban oases for people to relax and congregate. A hard-won lesson is that as great as has been the clamor for quiet spaces apart from the hustle and bustle of life, the experience has been that such places remain almost empty, favored only by a few. In contrast, urban oases in the midst of the hustle and bustle are always the more popular. Put simply, more people enjoy relaxing where they can see and be seen. We are, after all, social animals.

Big or small, such openings in the otherwise space-stingy modular maze of settlement outposts, they can be much greener if the vertical surfaces around the perimeter and vertical half-wall dividers within it, are given to wall-hugging narrow trees or shrubs, or better to living walls as described in our last issue. As dividers, living wall systems can easily be configured in 2-sided fashion. Using the "hanging gardens of Babylon" approach, more floor/ground space is available to paving tiles, seating, water features, and sculptures.

If the space, say a plaza in a prospering, growing settlement, is large enough, it may contain building structures playing supporting roles: changing space for performing artists, storage space for merchant kiosks, etc. These structures may also provide more vertical space to be given to living walls, and their roofs can be greenspace as well, so that the building in effect does not diminish overall ground space given to plantings. Roof top tea gardens would be popular, creating elevated spaces from which to watch passersby, and other activity on the main level.

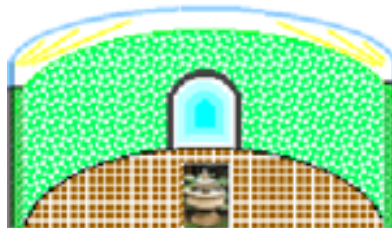

**Illustration** of a simple and small "greenhub" node, an intersection of 3 or 4 pedestrian

passageways. It sports a higher vaulted ceiling, painted a matte sky blue, with cove uplit with bright sunshine spectrum bulbs. Vertical surfaces are living walls. The floor is of brick pavers or cobblestones, with a scattering of benches, flowerpots, and a central fountain. Connecting pedestrian walkways are lower in vertical scale.

### Enter the pollinators

It is amazing how many people do not realize that plants come in male and female also. Be that as it may, we do need to provide for plant pollination. Bees might be confined to agricultural areas, with only persons not allergic to their sting working in those areas.

Hand pollination would be an unacceptable use of available manpower. Especially for agricultural areas, where similar plants are side-by-side, robotic hand-pollination equipment teleoperated from Earth where real labor costs are much lower, should be a priority area for research and development, with a lot of “spin-up” potential. In the meantime, we might concentrate on plant species that can be pollinated by hummingbirds. The sight of these tiny and beautiful creatures flitting to and fro in search of pollen syrup would do much towards making such urban relaxation spots all the more delightful. Might lunar hummingbirds slowly evolve larger subspecies? A hummingbird whose linear dimensions are 1.817 times Earth-normal for hummingbirds would weight as much on the Moon as our varieties do here.

We might make room for additional wildlife. Fish such as talapia, small tropical goldfish, even stream trout should mix well. But without adding in a mix of flying insects at great risk to serve as food, we’d have to feed them manually, or by automated fish-food dispensers.

Squirrels and chipmunks can do much damage, but they sure are delightful to watch. The same is true of rabbits and other small mammals. If only neutered individuals were released into the settlement commons, and breeding stock kept strictly sequestered, runaway populations could be avoided. Humans evolved side by side with plants and animals. Sure, some individuals would sooner be without them. But how truly “human” are they? We need to go into space as the front wave for Earth life at large. We just have to be careful what species we bring along with us. But that’s a whole new article.

If we are living, working, shopping, recreating, and traveling in pressurized spaces, there is no justification for any of these modules to be sterile, devoid of life. In our own cities, the boulevard is an icon for how pressurized roadways can be designed to contribute both to overall biosphere biomass, and to bio-diversity. Given the controlled climate, vehicles operating solely in pressurized environments can be open, roofless, and even open-sided. Of course, vehicles meant to operate at high speed would need wind-shielding.

### Various Larger Pressurized Passageway Options

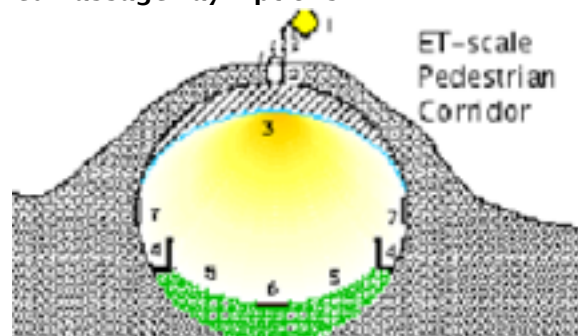

**KEY:** (1) Sun, (2) fiber optic bundle sunpipe, (3) sky-blue sunlight diffuser (same pressure either side), (4) pedestrian walkways, (5) terraced plant beds, (6) gardener’s path, (7) art & poster gallery



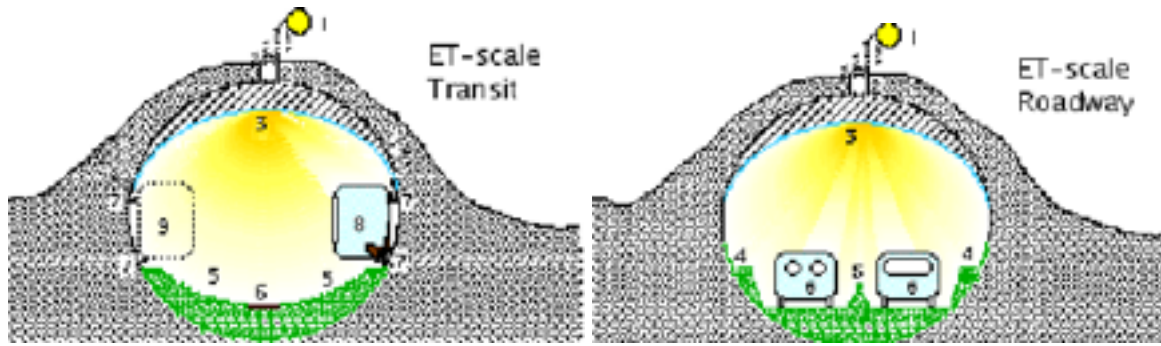

**LEFT KEY:** (1, 2, 3, 5, 6) as above. (7) wall-mount rail suspension system, (8, 9) bench seat transit car.

**RIGHT KEY:** (1, 2, 3) as above. (4) living wall / hanging garden, (5) planter-topped divider, (6) vehicles.

In all of these connector examples, there is a place for vegetation, and the more place the better. It is more than a matter of morale, the comfort of mothering greenery against the stark sterile barrenness beyond the settlement airlocks.

It is a matter of always paying heed to the overriding requirement to maintain a healthy and integrally functioning biosphere as a host to all other activities within the settlement hull complex.

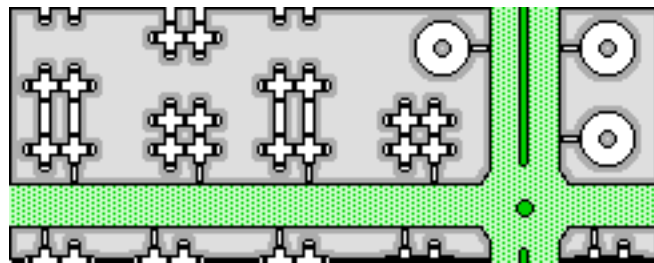

**ABOVE:** a sketch of how a residential settlement "block" grid could be laid out. The Green represents the pressurized road grid and its significant contribution to the total biomass of this modular settlement biosphere. One road is shown in boulevard fashion, with an expanded roundabout intersection centering on a tree & shrubbery inner circle. The gray represents the open-to-vacuum regolith covered surface. Shown in it, are various modular residences, individually regolith-shielded, all opening onto the pressurized road grid. This allows shirtsleeve travel throughout the settlement by pedestrians, bicycles, and electric vehicles.

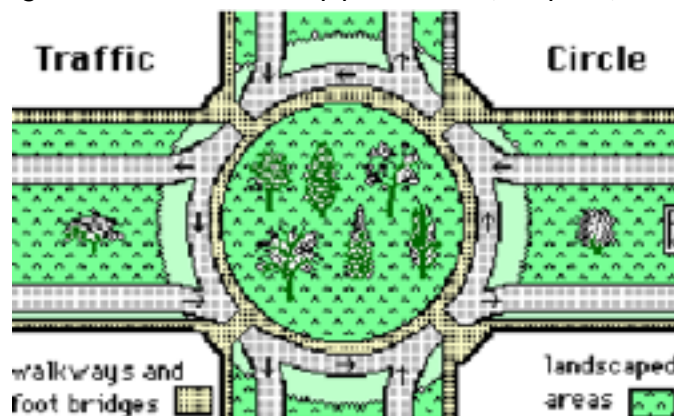

#### More on the Settlement's pressurized road grid

There is considerable discussion of many aspects bearing on the topic of public places in the lengthy article "Luna City Streets" MMM #109, October 1997, pp. 3-11. This article has

been republished in MMM Classics #11, pp. 61-69 – a free access pdf file download from:  
[www.moonsociety.org/publications/mmm\\_classics/](http://www.moonsociety.org/publications/mmm_classics/)

## MMM #204 – April 2007

# MODULAR BIOSPHERICS

By Peter Kokh

**I. Living Wall Systems, Continued from MMM #201** We recently found this excellent example to share.

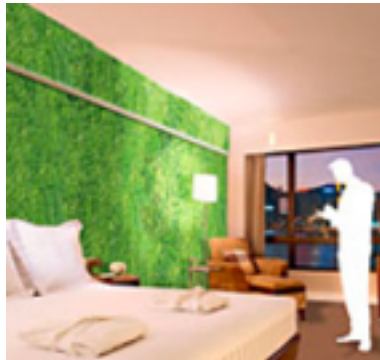

[Credit: Phillips & Co.] **A wall that breathes:** Envisioning some backlash against high-tech surroundings, designers conceived a back-to-nature hotel room with a lush "living wall" of grasslike vegetation. The wall, with a built-in watering and lighting system, would serve as an air filtering.

Reference: [www.usatoday.com/travel/hotels/2005-05-05-hotel-of-tomorrow\\_x.htm](http://www.usatoday.com/travel/hotels/2005-05-05-hotel-of-tomorrow_x.htm)

### Toilet-equipped Habitat & Activity Modules – Wolverton or alternate black water pretreatment systems

The organizing idea of "Modular Biospherics" is to distribute biosphere maintenance functions throughout a growing modular physical complex. This philosophy obliterates the "single point of failure" biosphere catastrophe scenarios to which any centralized system or complex of systems would be inherently vulnerable.

It is also a biosphere architecture that grows naturally as the physical complex of the outpost/settlement grows. The size of any "problems" that must be tackled in central, or neighborhood treatment facilities is greatly reduced. Modular Biospherics greatly reduces both the scope and the frequency of "growing pains" crises.

By distributing air and water treatment systems, biosphere maintenance becomes a democratic process: it is everyone's concern, and the immediate local consequences of neglected systems affect most those who are guilty of the neglect. We take Earth's immense biosphere for granted (up until recently, anyway.) On the Moon, the health of the minibiosphere of each settlement complex must be everyone's business or catastrophic failure will only be a matter of time, and will come sooner rather than later.

Living Wall Systems are designed to refresh air throughout the complex, with only local maintenance needed. Stale air sets off personal mental alarm systems rather effectively.

But we must also treat waste water, both gray (sink, shower) and black (toilet wastes: urine and feces) locally. Not only does this give us a further opportunity to "grow fresh air" within ever module that has a toilet system, but it helps pretreat blackwater at the source of the



problem, greatly reducing the treatment burden to be handled in a centralized, or, better (in tune with our “as the settlement grows” philosophy), in neighborhood facilities. Wastewater treatment systems that “grow clean water” should be in every habitation and activity module: not just in residential quarters, but wherever people work, shop, go to school, play, or are entertained.

Many systems have been tried, some of them quite ingenious, mostly in rural settings that lack central water treatment systems. Some of these systems require an exhaust to the exterior atmosphere sink to handle the odor problem. As we can’t exhaust stinky air outside on the Moon, at least not routinely, many “composting” toilet systems that work perfectly well on Earth will not pass muster on the Moon. The odor problem must be handled on the inside! That creates an extra burden, which to anyone with the proper attitude, translates to an inviting “challenge,” the kind of incentive that spurs ingenuity to greater achievement.

The Wolverton gray water system is one option that has worked for nearly 30 years in the home of retired NASA environmental engineer, Bill Wolverton in Houston.



**KEY:** 1 side- or wall-flush toilet; 2 blackwater tank with microbes to break down solids & destroy pathogens; 3 inert filter with irrigated soil; 4 plants rooted in wet soil mixture; 5 effluent water is 95% pretreated, ready to water plants in the greenhouse and elsewhere. – illustration by the author.

There are undoubtedly other systems, but Dr. Wolverton’s well-tested system sets the bar against which other systems must be measured. The system above handles the load imposed by two people. We need to know how many people-hours per day that translates. Are they home all day, everyday? Or half the day most days? Blackwater systems must be rated in people-hours capacity if we are to size them to the daily loads of other activity modules such as work spaces, offices, schools, shopping areas, etc.

If we can someday deploy a modular lunar analog research station facility, we will want to try a variety of such systems in order to verify how well they work, and how they compare on various performance parameters. This fits the goal of such an analog facility to demonstrate the technologies needed for actively growing lunar outposts and settlements. There may well be a commercial component of such experimentation, with various manufacturers contributing systems for the various modules in a high-stakes game of make or break.

The penalty of not aggressively developing a full suite of modular biospheric technologies is clear. The planned “visitable” (but no longer intended to be permanently manned) outpost must be constantly resupplied from Earth, or by a very wasteful program of local throwaway oxygen and water production. Engineers and architects of modules may prefer to “keep it clean, and sterile” but our job is to create a “biosphere flywheel” that largely maintains itself with a modest amount of monitoring. We need to keep dependence on resupply from Earth to a minimum, if we are going to progress to the point where those on the Moon can survive politically or economically driven cutoffs of support, be they temporary or indefinite. This must be our goal! <MMM>

M O D U L A R R  
B I O S P H E R I C S

**V\*. “Tritreme Drain Plumbing” – By separating drainage by source type, each can be more efficiently treated.**

By Peter Kokh

[Treme (Greek) = hole] Cf. MMM #40 NOV '90, “Cloacal vs. Tritreme Plumbing”  
[reprinted in MMM Classic #4, pp. 65-66]

Except in "new towns", it would be prohibitively expensive to switch to a new 'multi-treme' system, which keeps different types of sewerage separate from the beginning in order to benefit from simpler and more efficient source-appropriate forms of treatment, with the fringe benefit of enjoying whatever valuable byproducts such separate treatment may promise. Lunar and space settlements are "new towns". Infrastructure is 'change-resistant'. Thus it is of supreme importance to choose it wisely from day one.

**Purging ourselves of the MIFSLA habit**

The “Mix-First-Separate-Later” (MIFSLA)\* attitude to waste water management” has gone virtually unquestioned since the invention of urban sewage systems in a city whose name we do not know, but whose ruins we refer to as Mohenjo-Daro, on the Indus River, about 200 miles NNE of modern Karachi, Pakistan, in 2,500 BC, four and a half thousand years ago. Another case of infra-structure being the most difficult thing to change, and thus the thing that deserves the most attention.

MIFSLA is so ingrained, it is taken for granted, almost never questioned, never thought of. “It’s just the way we have always done it.” How many times have you heard someone say that about something?

**Waste Water treatment by Source Separation**

[www.holon.se/folke/projects/vatpark/Kth/guntha.shtml](http://www.holon.se/folke/projects/vatpark/Kth/guntha.shtml)

On the Moon, where we are starting fresh, we have not only the ideal opportunity to do so, but an urgent imperative. Creating and maintaining a functional biosphere is daunting enough. Creating one that will keep operating as both the settlement and its biosphere keep growing ever larger.

“The conventional waste water management system is unable to purify the sewage water to a higher grade than the nutrient content of the grey water. Biological plants are not well adapted to the purification of a mixed sewage, but if source separating toilets are used, the urine and feces could be used for agriculture, and the grey water could be efficiently purified with biological methods to a grade that it can be reused in the settlement.” Folke Günther, Stockholm – URL above

Obviously, if we are going to build and grow settlement biospheres in modular fashion, with contributing components in each new habitation and activity module, we don’t need to make it more difficult simply for the sake of “the easiest (most familiar) way.”

**The MIFSLA Way of Doing (or not doing) Business**

- Clean water is mixed with urine and feces to a polluting mixture, both regarding plant nutrients and pathogens.
- This mixture is in turn mixed with a fairly clean grey water (sinks, bathtubs, showers, laundry).
- The resulting mixture is diluted with drainage water (rain) (About 80 m<sup>3</sup>/person\*year [19]) in an extensive web of piping.
- Finally, the mixture is expensively purified to a quality comparable with the original grey water, but with a doubled volume.

Folke Günther, Stockholm – URL above

Wetlands-type systems accepting MIFSLA loads do not do as good a job, especially in reducing phosphorus content, as would be possible if the differing loads were treated separately.

### **Common Toilets mix wastes also**

In the common water closet, urine and feces are water-flushed together. But there are several designs which separate most of the urine from the feces, so that both can be treated and recycled as agricultural fertilizers separately. There are several types of composting toilets designed for off-the-plumbing-grid use, and they function well, if instructions are followed.

At the Mars Desert Research Station, the original toilet was a composting one, operated poorly, with high odor problems. This may have been the result of improper installation, but more likely was the result of higher load (more users) than it was designed for.

We personally favor the Wolverton System, in which combined urine and feces are flushed into a tank inoculated with microbes to destroy the pathogens and break down solids, the effluent feeding a runoff planters producing clean fresh odor-free air, green foliage, under sunlit conditions. Such systems are load-restricted, but if used in every habitation or activity module in a number to match expected loads, would both turn the black water into gray water while contributing to the biosphere mass and function. This seems the best match for "Modular Biospherics" that we have seen, however, improvements and alternatives are always welcome.

In our earlier article, written long before we heard of the Wolverton system, we suggested that toilet wastes be collected in changeable holding tanks. You would put a full one "out front" to be replaced with an empty one, by a municipal utility service. Utility personnel could make the switch in your home at an extra fee for convenience.

Separate drainage can be carried much further. Waste water from various types of industrial operations each have varying types of adulteration, each suitable for a special kind of treatment. Mixing industrial waste waters makes no sense and compounds the problems.

To insure proper installation and connections, drainage systems meant for different types of effluent could be color-coded. This is a system that we can make work. We need only the will to do it right.

### **Separate Gray Water Benefit**

Pretreated odor-free gray waters irrigate "Living Walls" and can feed waterfalls, fish streams, fountains, and other delightful water features. The result would be a more pleasant settlement. <MMM>

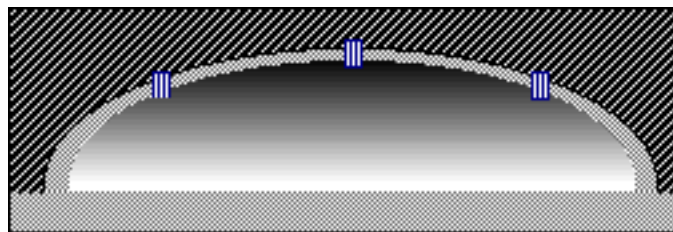

### **Unpressurized Out-Vac Sports Arena**

**Sporting Activities in airless vacuum on a moondust surface  
in 1/6th gravity in a thermally mild, radiation-free environment**

By Peter Kokh

In the illustration above, a shielded dome (it could be any architecturally practical shape capable of supporting a couple of meters~yards of sheltering moon-dust (as much of a load as a foot of equivalent material in Earth gravity). The dome-vault-shed could be of any size. The

first one might be small, for demonstration purposes, but eventually “stadium-sized” out-vac areas could be erected for inter-settlement league team sports.

#### **Advantages of this environment:**

- It does not need to be filled with air (that much nitrogen as a buffer gas would be expensive and extravagant)
- It allows sports in vacuum, on the moon dust surface, giving the authentic feel of the lunar surface, but without exposure to cosmic rays, intense ultraviolet, and micrometeorites
- It is isolated from the dayspan/nightspace cycle and is thus thermally mild or benign. Expected playing surface temperature, and temperature of the dome ceiling would be the same as two meters~yards under the lunar surface, c.  $-4^{\circ}\text{F} = -20^{\circ}\text{C}$  (it is better for the environment to be cooler than the players, so as to absorb their excess radiated heat.

We’ve seen photos and video of the Apollo astronauts, encumbered as they were by very heavy life-support packs, and very cumbersome space suits, hop and romp on the lunar surface. We wonder how high and how far we could jump, without all that excess weight.

In this more benign “lee vacuum” environment, we might have a chance to find out. Not only are the dangers of radiation, ultraviolet, micrometeorites, intense sunlight all avoided, but by raking the moon dust floor free of rocks down half a foot (15 cm) we remove risk of suit and/or visor puncture. In the process, we could also remove most of the troublesome powder component if we wished.

#### **Lighter Sports-suits**

We have previously recommended shielded but unpressurized sheds for warehousing items needing to be regularly accessed or serviced as this would allow the wearing of lighter pressure suits allowing greater agility, for less tiring prolonged work activities. Let’s take this up a notch. For sports activities we could wear what is called a counterpressure “skinsuit” much like a modern diving suit. It would be lighter and far less constricting of arm, leg, and torso movements.

Helmets could have more ample visors that extended the field of view to what we normally experience on Earth without any headgear. If we are going to have out-vac lunar sports, we need the right outfits.

#### **Supported activities**

Larger shielded but un-pressurized arenas would be ideal if we were to develop exciting lunar surface team spectator sports, as we will, in time. Volley Ball, anyone?

But we can also imagine a whole lineup of lunar surface track & field events from sprints, relays, hurdles, pole vaults, javelin throws, to long jumps -- you name it.

Gymnastics too! We could have trapeze setups and trampolines to see how high we can really bounce! And why not circus type acrobatics on the flying trapeze!

#### **The first of many**

A facility like this could be created by one major settlement, with a local settlement-wide league for team sports. But as the rules of the various games matured as we became more experienced with what we can do inside such an environment, and as other settlements grew in size, it would be sure to be copied, and become a truly lunar experience. When otherwise unused, this could be the testing ground for new moonboots, moon bikes, etc.

#### **A must-see, must-do tourist experience**

Supported activities would quickly become a signature part of lunar culture. Glass-walled pressurized areas along the perimeter would house ticketed spectators and VIPs. Events in these arenas, if they evolved to a stage were they were truly exciting to watch, might be televised to Earthside audiences by ABC’s Wide Worlds of Sports on Sunday afternoons. Even tourists would want to get in on the act, using the facility when teams were not. A chance to get

the full experience of lunar gravity on a somewhat natural lunar surface would rank high on the list of draws.

### **Unprotected Out-vac Sports**

We have written previously, in several articles, about various ways the incurable “outdoorsman” might find some satisfaction on the Moon. We especially recommend the following read:

MMM # 111 DEC. '97, p 6. Opportunities on the Moon for the Incurable Outdoorsman [also in MMM Classic #12 p4]

There will still be yearning and support on the part of the more rugged and unfettered outdoorsman for sporting experience of moonscapes “in the raw.” Some of these will be road rallies, long distance races over rugged courses, mountain climbing, lavatube spelunking, just plain hiking, and more. We are not all cut of the same cloth, nor should be the ways we let loose. <MMM>

## **MMM #208 – September 2007**

### **Lunar Settlement has Already Begun**

By Peter Kokh

“Say what?” “How did I miss that?” “Didn’t see anything like that in the news!” Well, yes you did, if you are old enough. Now I’ve got you really puzzled!

If I asked you what is the very first element of a future settlement to be put in place, you might suggest a habitat command center, or a solar power array system, or a transponder to guide incoming ships to the exact chosen location. Good suggestions, and getting close with that last one.

Before the construction teams, human or robotic arrive on any scene, comes the site assessment and selection team, again robotic, human, or both. And it is all the same whether a decision is made to build a settlement on the visited location or not. The scouting effort is most likely to have left equipment & other objects behind not needed for the trip back home to Earth, or for study on Earth. “**Garbage**” and “**Trash**” protested the self-appointed guardians of the Lunar Sanctuary as the Apollo 11 ascent vehicle blasted off the plains of Tranquility to bring our first two explorers and their hoard of moon rocks back to our home planet.

Ah, the light bulb goes on! (we hope.) That so-called trash will become the most precious and valuable contributions to a future lunar settlement museum. Now you’ve got it! We didn’t trash the Moon, we left priceless relics of our first visits.

#### **The First Elements of Lunar Settlement are Already in Place on the Moon**

They are the artifacts and other evidence of the first human scouting missions to the Moon, that one day will be held in trust by Pioneer Museums for the benefit of the Lunan Settlers and all mankind.

The hue and outcry began with the liftoff of the Apollo 11 ascent module, and continued with the liftoff’s of the Apollo 12, 14, 15, 16, and 17 crews. Also of value are robotic landers and rovers that landed on the Moon. Probes that crash landed will not likely be in salvageable.

So what’s the big deal? Well, it is a big deal. Someday, lunan parents will take their kids to the Luna City Museum and other museums in lunar settlements to help them understand the roots of their pioneer frontier cul-ture, the first stages in their learning to make themselves at home on the Moon, now a familiar world, no longer alien. Here they will see the first artifacts of the great, unprecedented first steps of humanity off its home world, to explore and understand a neighbor continent unto itself so different, so seemingly hostile and barren.

Museums have that power to put us in touch with forgotten beginnings, to help us appreciate just how many shoulders we stand upon, and the sacrifices and pioneering efforts of generations who have gone before us to make the life we now have possible. And this is vital for a future-looking frontier. The Moon will open the rest of the solar system someday. And keeping this march into the endless frontier rooted in the depths of the past will keep us on target, keep us human, and, as different as our life is from that of the pioneers, we will come to understand and appreciate. It has begun! <MMM>

## MMM #222 - February 2009

### Elevating Lunar Railways Above the Surface

By Christopher D. Carson

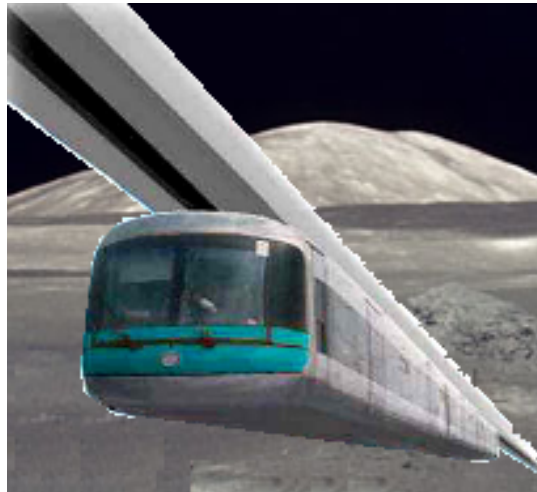

I have read with interest the discussion of lunar railroads published in recent MMM issues and on the Google Group: [Railroading on the Moon and Mars](http://groups.google.com/group/railroading-on-the-moon-and-mars?hl=en).

<http://groups.google.com/group/railroading-on-the-moon-and-mars?hl=en>

The idea that, at some stage of lunar settlement, a high-capacity means of transportation for personnel, goods, and raw materials between sites on the lunar surface will become desirable appears a sound one; nevertheless, the significant differences between terrestrial and lunar conditions perhaps make it desirable to deviate from established terrestrial practice more than your contributors have generally proposed.

In particular, I would suggest that some form of elevated carriageway is desirable. Firstly, the lunar surface is very uneven, and that unevenness is distributed very differently from the unevenness of the terrestrial surface, having been (in the main) produced by very different processes.

Considering the low lunar gravity, which increases the allowable unsupported span length, the operational problem of erecting a suitable support structure which is only in contact with the ground at intervals may well be less than that of grading and blasting hundreds of kilometers of right-of-way across cratered terrain.

[Ed. for passengers and tourists, elevated systems will provide a better view, over a more pristine landscape.]

### **Advantages: dust control and thermal management**

Secondly, elevating the carriageway introduces at least two major advantages, with respect to dust and to thermal management. The lunar surface is dusty, and a passing train can be expected both to disturb the existing surface dust by its vibrations and to generate new dust by mechanical breakdown of the ballast. This dust will tend to foul rotational joints such as wheel bearings. As the rate of dust collection on a surface can be expected to decrease rapidly as that surface is elevated above ground level, and no definite requirement for a ballasted roadbed appears in an elevated system, this problem can be reduced significantly. Again, although the soil is a relatively good thermal insulator, a ballasted rail system laid across the surface will tend to approach the surface temperature.

The diurnal variation in temperature, especially in low latitudes, is large in comparison to terrestrial norms, and issues related to thermal expansion (already significant in terrestrial experience) are correspondingly magnified. Conductive heat transfer can probably be limited to a much smaller value in an elevated system than in a ground-level system, and if the surfaces of the carriageway are mostly metallic (polished where possible), their low emissivity will limit radiative transfer as well. The use of electrical heating at night, and passive or thermoelectric-assisted radiative cooling during the day, will permit maintaining the carriageway close to a constant temperature without impairing its mechanical properties (unlike keeping it heated constantly to its peak daytime temperature).

There are two general arrangements that are especially suitable to elevation, namely the monorail and the cableway. Either would permit high angles of bank, as required for stability in sharp turns under low gravity. The underslung monorail, having pendulum stability, is arguably preferable to the superincumbent type but either can exhibit more lateral stability than the ordinary railway, if constructed with the wheels or rollers necessary to apply moment reactions against a rail in the form e.g. of a box girder.

Of course, under lunar gravity the permissible column length will be extended considerably, so that an elevated carriageway will not need to follow the terrain elevation as closely as a surface carriageway, and curves can in general be made much shallower. While a lunar cableway can probably be built for much heavier traffic than its terrestrial counterparts usually see, it will tend to have greater frictional losses than a rail system (due to the cable working against wheels or skids at each support), and the cable will require frequent inspection and renewal against the danger of abrasion by trapped dust grains. For most purposes, therefore, the monorail will probably prove superior.

### **Powering the system**

As an alternative to the usual mechanical type of railway, the magnetic-levitation carriageway also deserves consideration. In particular, the "passive" maglev guideway, which need be little more than an aluminum trough, would be relatively simple to fabricate and install. This throws the burden of support and propulsion upon the train, but the one can be provided using rare-earth magnets in the car structure, and the other by a linear induction motor, probably in the foremost (for driving) and rearmost (for braking) cars, although in practice all cars would probably be motor-equipped to ease the problems of train assembly.

As with all forms of lunar transport, power will have to be supplied either internally, from batteries or some form of generator, or externally from a feed. The external supply in all cases may be a cable energized with single-phase alternating current and tapped by pantograph, although the return will largely be by way of the rail rather than the ground as in terrestrial applications. (Capacitive coupling between the car and the guideway makes this possible for the maglev.) For the maglev, as frictional losses are small, propulsion is ordinarily required only intermittently, which in principle would permit power pickups (fed, perhaps, by spot beams from a power satellite) to be located at intervals, eliminating the need for a continuous cable. Safety and other considerations, however, probably render this a questionable economy.



In general, human nature remains the same, and the generic problems of living are the same in Luna as in Terra; but by as much as conditions differ on the two planets, so much will our solutions need to differ. Keeping sight of these principles, if we apply imagination and good engineering sense, we should be able, not only to survive, but to thrive.

Christopher D. Carson <http://www.lunarcc.org/>

## Lunar Railways: Surface & Elevated

By Peter Kokh

In the above article, Chris Carson lays out a number of considerations that arguably favor an elevated approach to lunar railways. But he himself says that he is looking at “some (future) stage of lunar settlement, (when) a high-capacity means of transportation for personnel, goods, and raw materials between sites on the lunar surface will become desirable.”

### **Lunar Railroads not as a later development, but as an early means of settlement expansion**

David Dunlop and I, believe that railroads should be part and parcel of lunar settlement expansion from day one. If there is a central spaceport feeding a growing beachhead of habitation, commerce, and industry, a rail system will be the easiest way to move heavy modules around. The chosen location, unless we are insane, is likely to be a level one (oops! I guess that leaves out the Shackleton rim!) and laying rail beds should be fairly straightforward.

If our initial site is in a lunar mare basaltic plain, expansion to new settlement locations by rail will be easy as well. There are, of course, some mare features that pose problems: wrinkle ridges and rilles. The forme will need to be cut or tunneled through, the latter to be bridged or detoured altogether. But in general the near-side mare-plex is relatively flat. Elevation changes are of low grade.

### **Beyond the Flats**

Where railroad routing will pose a challenge is in the cratered highlands. I say “pose a challenge” because mid-nineteenth century railroad engineers managed to conquer the Rockies and, in Europe, the Alps.

Still, there are clearly cases where elevated rail systems are more desirable, for example through very scenic and geologically special terrain that we will want to disturb as little as possible.

In situations like this, especially with railways designed principally to cater to the tourist trade, elevated monorail systems may not be the initial choice. Cableways, with cars descending and rising between the cable towers might be less expensive to build.

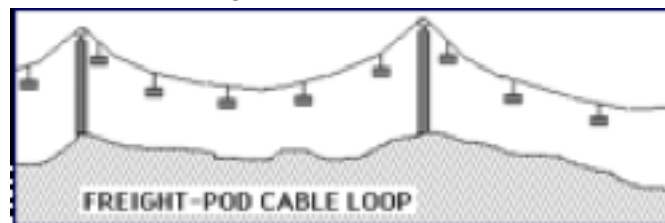

As population and tourist traffic grows, a suspension cable systems in which cars ride a horizontal cable suspended from a tower hung cable much like the roadway of a suspension bridge, might be a welcome upgrade even though it would be more expensive, requiring more steel.

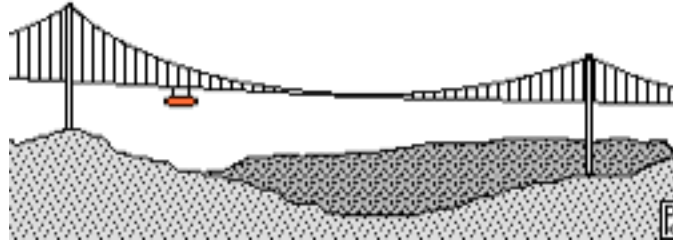

### **Rights of Way: expensive on Earth, free on the Moon**

Elevated monorails and maglevs, as opposed to cableways, will be built when high speed passenger traffic grows in volume. Today, these systems are still too expensive, because they need all new road beds and rights of way, which tilts economic decisions in favor of high speed trains on traditional tracks along established rights of way. On the Moon, securing new rights of way will not be a problem, and decisions will be made on other grounds.

### **Terrain stability and “moonquakes”**

Another consideration may come into play: one thing that we did not realize until sometime after the Apollo period is that some areas of the lunar surface are subject to “moonquakes.” These events are analogous but different from “earthquakes.” On the Moon, quake epicenters lie very much deeper below the surface, and the quake lasts not seconds, not just a few minutes but for periods as long as an hour or more. While on the Richter scale, these events are of mid-range, c. 5.0 at most, the damage that they can cause because of the duration, could be very serious. Now we don’t really know. On Earth, the greatest damage is where the ground is soft, wet, or fluid in the first place. On the Moon, the surface is compacted regolith over fractured bedrock almost everywhere. We will be learning some hard lessons from experience.

While on Earth, quakes are caused by the build-up of tectonic stress, on the Moon, where there is no such thing as plate tectonics, the cause seems to be in instabilities very deep inside the Moon.

Now to our present knowledge these quakes are much more common in some areas than in others. In many areas, concrete maglev roadbeds suspended on pylons may have an indefinite problem-free lifetime. In other areas, surface systems may be more prudent.

### **Expansion/contraction with heat / cold**

Chris brings up the problem of thermal expansion and contraction of rails exposed to the lunar heavens. This is a problem that we recognized early on in our 1993 paper, “Railroading on the Moon.”

[http://www.moonsociety.org/publications/mmm\\_papers/rr\\_moon.htm](http://www.moonsociety.org/publications/mmm_papers/rr_moon.htm)

In this paper we discussed various ways of shielding the rails from direct sunlight:

- Putting them underground, in tunnels.
- Using a suspension system that allows the trucks or bogies to ride on rails in a shaded box,
- Putting each rail in a box covered with shutters that swing aside just in time, and
- Suspending cars from an inverted box beam supported by pylons, much as Carson suggests.

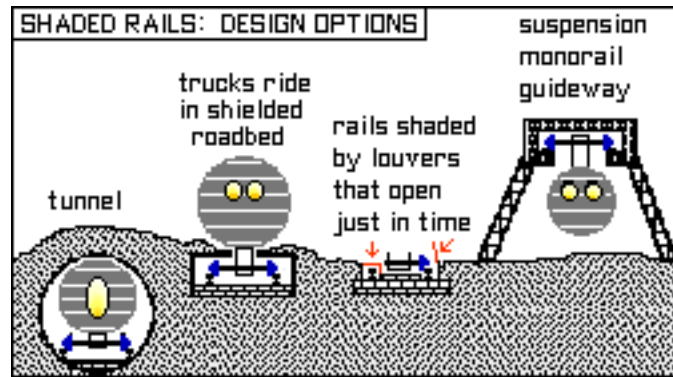

Over time, even the two “shaded” ground systems would absorb enough light by radiation from other surfaces. That is also a design problem.

### Economics

On the Moon there will be an ever changing equation which will indicate which way to go. Into this equation we put the current cost of producing the various structural elements needed:

- Sections of steel rails
- Rail ties of concrete or some other stable material.
- Pylons for elevated systems
- Concrete maglev guideway sections
- Superconducting guideway elements
- Construction equipment for surface roadbeds
- Construction equipment for erecting pylons
- Cable
- Cable towers
- Construction equipment for erecting towers

### Evolving local industry

The system that is cheapest and the cost ranking of the above elements will be constantly changing as we expand from a first outpost beachhead into an initial settlement and then to outlying settlements. Expansion will be driven by the constantly shifting economic and resource advantages of diverse locations.

So what comes first? Initial industries or imported components? The classical chicken or egg dilemma derives its mystery from overlooking the rooster’s role. There has to be a pump primer, and Dunlop and I are convinced that the first elements of a railway system must be reused parts of lunar landers and cargo holds, designed specifically with such reuse in mind. That makes them “stowaway imports” if you will, their cost being absorbed as part of the cost of the lander, We have written before of this trick of thinking outside the mass fraction box by simply finding a way to count everything arriving on the Moon as payload. We do that by predesigning everything needed to take the “listed payload” to a safe landing on the Moon, for subsequent reuse on the Moon, For example, the lower platform of the lander, to which the landers legs are attached, could be designed for a second, longer lifetime as a four-wheeled overhead crane.

What industrial products come first will depend in part on where the site is located. A site along a mare–highland coast with access to both suites of regolith, will have some advantage when it comes to industrial diversity. To those who think only in terms of iron and aluminum. That advantage is nil. That is self-limited thinking, the kind that will get us started only to putter out prematurely. The “easiest” place to start may not be the best place to start. We need a long-range view.

The most important thing to keep in mind, that the most important role of lunar railroads, will be, as on Earth, carrying freight and raw materials. At first these systems will carry people too. In time, along heavily traveled passenger routes, dedicated high speed luxury systems will be built. The pioneers will need both just as we do.

It will make sense, for example, to place a plant that manufactures pressurized modules for habitat and activity use, for school, office and commercial use, for pressurized walkways and roadways in one central settlement, and to carry them by rail to where they will be used. These modules will be what we'd call "oversized," Seriously so. But on a world where right of way acquisition will be easy and cheap, there is no reason not to build rail systems with generously wide track gauges.

Without such a rail factory to market system, every little settlement would have to build its own modules. One result would be much less diversity in module types, leading to cookie cutter towns and neighborhoods. Only this kind of railway, serving three kinds of needs can build the kind of frontier we'd want to live on.

### **Iron rails and cables**

Iron is available everywhere. Finding alloy ingredients to turn it into a serviceable iron or even steel will be a challenge because the usual stable of alloy ingredients are not abundant enough on the Moon, in either highlands or the maria (although the titanium rich mare areas confer an advantage) and we have a lot of "path-not-taken metallurgical research to do. So far, no one seems to be looking at this. We have been sounding this trumpet for two decades. There are sure to be new lunar-producible alloys that will have a market on Earth, justification enough for a "spin-up" R&D effort.

So when it comes to cables as well as rails, rail car trucks or bogies, and many other railroad needs, we are back at square one having to start from scratch to build a stable of serviceable alloys using only elements that can be economically produced on the Moon.

### **Concrete ties, guideways, and pylons**

So can we build concrete railway ties? Can we build concrete maglev guideways, concrete pylons? Research by T.D. Lin over the past two decades seemed to have demonstrated that concrete twice as strong as the common variety in greatest use could be made from highland regolith. Now suddenly there is doubt about this, as the work of others leads to the suspicion that Lin overlooked the fact that curing concrete sucks a lot of carbon dioxide out of the air. On the Moon that would be a problem. Carbon is too precious on the Moon, needed for food production and other biosphere needs, to allow it to be sucked up by curing concrete, no matter how useful that concrete may be. There is magnesium-based concrete but here on Earth, its uses are limited by its properties. The vast bulk of the building material research that needs to be done has as yet received very little attention outside of the pages of MMM. **PK**



**Image by PK**

Yes, we'll have to change some things! But why Not?

MMM #224 – April 2009

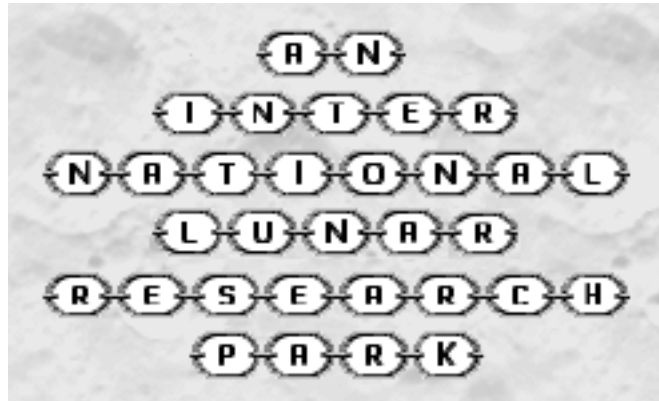

### An Open-ended Lunar Initiative v. 2\*

By Peter Kokh and David Dietzler

- V.1 published in MMM-India Quarterly (Feb. 2009)

#### Current Prospects

The United States, under former President George W. Bush, redirected its ISS and Planetary Exploration-focused Space Program to a “return to the Moon” and “beyond to Mars.” This direction will probably continue under President Barack Obama. Meanwhile, China, India, and Japan have launched lunar probes and spoken of putting crews on the Moon. Whether these will be one time “science picnics” à la Apollo or real efforts to establish permanent facilities to support manned exploration sorties and other activities remain to be seen.

#### The Question

If each nation picks a different location on the Moon for its surface activities, areas of cooperation are limited to data sharing, tracking, and other support activities.

If, however, some or all national lunar outpost efforts are concentrated at one and the same location, be it at the north or south lunar poles or somewhere else, then the opportunities for shared facilities is enormously increased, and with it could come major savings by reducing unnecessary duplications.

#### Shared Facilities: Corporate Partners

Of course, then the question becomes “who will build and provide the facilities to be shared? And right here we have the opportunity to introduce new parties: contractor companies. Possible contractors could include Boeing, Lockheed-Martin, EADS, Antrim, and other names associated with the Aerospace industry, but also other major contractors. To pick a few: Bechtel, Halliburton, Mitsubishi, and on and on.

#### Added Players: Enterprise, University Consortia

If we collectively choose to establish not a collection of national outposts, collocated or not, but an “**International Lunar Research Park**” the possibilities for future expansion, elaboration, and outgrowth – even into the 1st human lunar settlement – will increase greatly.

#### Facility Lists

The lists below are meant to show how great are the possibilities for diversification and outgrowth. The items in **bold** will come first. Plain type next, italics last. Note, that this sub-classification is just one person’s first attempt, and corrective input is most welcome. No one expects to “get it right” the first time! What we want to do is to put out the general concept of how enormously the choice of an International Lunar Research Park could bust the future wide

open. After the itemized lists (we surely have forgotten or not thought of many items!) we will give our thoughts on just what must come first.

#### **National Outpost “Core” Elements**

- **base habitat**
- **base laboratories**
- **basic life support**
- **command center**
- **airlock**

#### **Contractor Corporation Services**

- **Site preparation**
- **Spaceport services**
- **Construction equipment**
- **Shielding services**
- **Solar wind gas scavenging**
- **Fuel storage**
- **Fuel production**
- **Power generation**
- **Power storage**
- **Warehousing systems**
- **Thermal management**
- **Waste treatment**
- **ISRU Research**
- **ISRU Manufacturing**
- **Habitat expansion modules**
- **Agricultural modules, basic agricultural services**
- **Biosphere maintenance**
- **Road construction**
- **Connector modules**

#### **Enterprise Opportunities**

- **Commons with meeting space**
- **Restaurant(s), pub(s)**
- **Recreational facilities:** exercise, sports, dance, theater
- **TV/Radio Facilities, satellite communications telephone system, internet provider**
- **Instruction, continuing education – keeping up to date with improved lunar systems**
- **Financial services**
- **Hotel facilities** for visitors, tourists, overflow between crew changes
- **Cabbotage** (outfitting) services
- **Surface transportation (passenger, freight)**
- **Vehicle maintenance**
- **Space suit services**
- **Tools, equipment**
- **Recycling services**
- **tour coaches & excursion services**
- **marketplace**
- **agricultural production, products**
- **green (horticultural) services**
- **reassignment services (new roles for scavenged parts of landers etc.)**
- **agricultural production**
- **customization services**
- **event management**
- **surface recreation vehicles**
- **archiving services**

## University Consortia

- **Medical Center**
- Continuing education
- Research facilities
- Astronomy installations

## Joint Civic

- **Road planning local**
- **Road planning regional**
- **Environment protection**
- **Environment enhancement**
- **Inter-Sector coordination** (Contractors, Enterprise, National, University)
- Parks, parkways, gardens
- Outstation planning

## Discussion – where you come in!

It would be miraculous if the list above did not have many holes, even if nothing was misclassified. Your input is most welcome!

The effort above is an attempt to start a discussion and to keep us, nationals of the various countries contemplating lunar surface activities, from being blind-sighted to the enormous advantages to be gained not only by collaboration between the various national agencies, but by restraining agency hubris and by taking the plunge to invite corporate, enterprise, and university consortia as equal partners in a joint “human” effort.

The idea is for the national outpost agencies to buy or lease or tent equipment and services from the contractors and enterprises as their needs change and expand. This should provide not only substantial cost savings but a greater variety and supply of equipment and services.

Agencies need not provide quality and other specifications, because corporate and enterprise personnel would be just as much at risk from improperly designed and manufactured equipment as would national agency crews. Toss out the mind-boggling bureaucratic paperwork, and down comes the costs.

Corporation employees would need housing, and all the other life support services as needed by the agency crews so it is natural, that as they begin to construct pressurized modules and other equipment from lunar building materials that they could provide for expansion of national outposts as well at considerable savings.

The national outposts would be “anchor tenants” so to speak, but as in shopping malls, in time their share of the economic value of total activities and facilities at the site might become, even though essential.

Some sort of Civic Council representing all of these Parties would be needed to make decisions that affect every-one, decisions about growth directions, environmental safe-guards, and so on. As this unfolds, the International Lunar Research Park will have become the first lunar settlement!

It is time for humanity to open the next continent, one across a different kind of sea. The “out of Africa” effort is ready for the next act. Only humans as a species, not horse-blinded agency managers, have the vision to grasp what is needed – and it is not a collection of agency outposts!

**What Comes First?** Frankly, national agency planning puts the cart before the horse.

**Why?** Two things come first, and no one is giving either of them more than trivial attention.

## Part I: Developing now the Technologies needed for using lunar resources

We are not going to anything of lasting significance on the Moon unless we learn how to process useful building materials out of the elements in moondust. Known by the uppity Latin term “In Situ” Resource Utilization (“on location” works just fine!) various processes have been proposed to isolate oxygen and other elements, but few have been tested either in laboratory scale or (more importantly) in mass production scale. How do we advance the “readiness” state” of these technologies? It is important to have them ready to go when we land on the Moon.



Getting there, and then having to scratch our heads for additional time-wasting decades makes no sense. But that is the path we are on.

[This topic is the subject of “**Improving the Moon Starts on Earth**” in MMM #s 132,133, Feb/Mar 2000.]

## Part 2 – Site Development

No site on the Moon, no matter what advantages are touted on its behalf, is anything but “unimproved” land, what in might be called “Florida swampland.”

Before the first national agency manned lander sets down on a chosen site, it makes sense for a corporate contractor to have already “improved the site” – conferring on it various advantages that will make outpost deployment, construction, and operation so much easier. Indeed, Carnegie–Mellon University, a contestant for the Google Lunar X–Prize, has just proposed that establishment of the first spaceport be contracted to the university to be done by telerobotics.

[www.post-gazette.com/pg/09063/952880-115.stm](http://www.post-gazette.com/pg/09063/952880-115.stm)

This is the subject of the article, “**The Developer’s Role**” from Moon Miners’ Manifesto #131, December 1999. **Both articles are combined in one Online Paper:**

**“Improving the Moon & the Developers Role”**

[www.lunar-reclamation.org/papers/improving\\_moon\\_paper.htm](http://www.lunar-reclamation.org/papers/improving_moon_paper.htm)

**Also relevant, “The Outpost Trap”** serialized in MMM #s, 198, 199, 200 September, October, November 2006 [www.lunar-reclamation.org/papers/outpost\\_trap.html](http://www.lunar-reclamation.org/papers/outpost_trap.html)

<PK/DD>

## MMM #232 – February 2010

### Lunar Base Preconstruction



#### A Basic Public Demonstration of Using Moondust to Make Building Materials

By Peter Kokh

**PK:** I had been invited to sit in on a presentation of Jay Witner’s “Apollo Village Proposal” during the 2009 Inter–national Space Development Conference in Orlando, FL over the Memorial Day Weekend.

To put it in a nutshell, Jay was proposing that we raise seed money approaching one million dollars to convince the government to fund a pre–construction mission on the Moon. Teleoperated bulldozers and other equipment would be sent to a spot on the Moon that had been previously selected for a NASA Moonbase. At that location, the selected equipment would be delivered by a Delta launcher and begin to “make bricks.”

Jay would use solar concentrators to melt moon dust in molds. Actually, you can compact moon dust and use microwaves to sinter and stabilize the outer layers, and for many purposes that would be good enough.

“The public has never been shown that we can go to space and build structures out of local materials. Live video of buildings going up on the face of the Moon is an incredibly powerful means to ignite interest in and support of our space program.”

We do not have the expertise to weigh the merits of Witner’s proposed methods. Nor should this article be construed as an acceptance of their feasibility. But his proposal did get us to thinking:

**What can we do with bricks made by sintering?**

The suggestion that we make buildings ready for astronauts to occupy seems to us to be rather impractical. It is our own non-professional expectation that no structure made of bricks, no matter how well made, can hold pressure against the outside vacuum.

But fortunately that does not exhaust the possibilities. There are several practical construction projects in which brick structures can play a supporting role in setting up a lunar outpost. Let's look at some of them.

Depending on the north/south latitude of your chosen location on the Moon, brick walls could provide shade for things stored out on the surface that must be kept cool, or at least, must not be allowed to get too hot; Tanks of fuel and/or various gasses, for example. Tanks storing blackwater (toilet) wastes are another example. Eventually, such wastes will prove most valuable as a source of agricultural nutrients, but we may not be ready for such operations right off the bat.

How high a shade wall would have to be will depend on the latitude. At the equator, it would throw no shadow and be useless. So such walls will be more helpful at middle to polar latitudes, north or south.

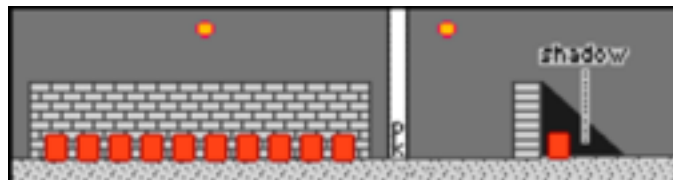

Bricks can also be assembled into columns sturdy enough to support space-frame canopies for unpressurized lee-vacuum storage areas protected from the cosmic elements of radiation, solar flares, micrometeorites and the extremes of dayspan heat.

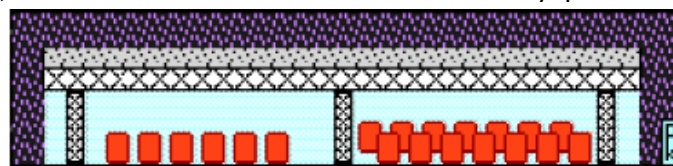

As we are talking about mortarless applications, a better brick/block design would take a cue from the familiar interlocking "Lego" toy plastic blocks.

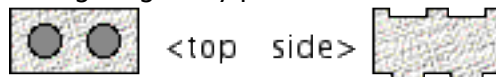

Another use for simple bricks would be to create retaining walls for moondust used as shielding.

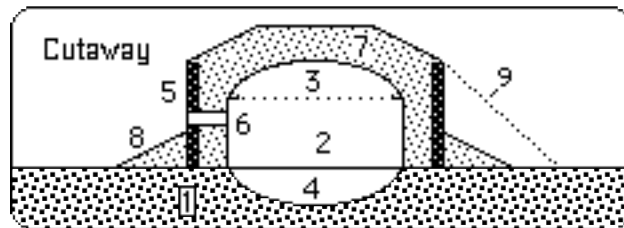

In the illustration above, (9) represents the slope of the moondust shielding mound if a retaining wall were not used. Now in 1/6<sup>th</sup> gravity, the weight of the retained moondust might not exert enough pressure to topple a well-built brick wall. Experience will tell, however.

A better option would be to use the now-common bottom lip design of retaining wall landscaping blocks

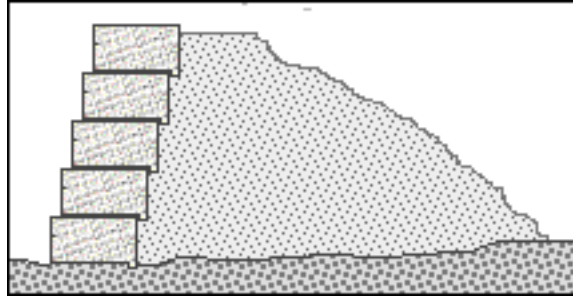

### Beyond bricks: pavers

Closely related to bricks are “pavers” which can be brick like in size and thickness up to much bigger slabs. These would have a use as well, for example serving as pavement for rocket landing/launch pads to cut down on the spray of sandblasting moon dust driven by rocket exhaust. Such pads would be bermed as well to present a horizontal barrier; and these berms could well be confined between retaining walls.

### Beyond bricks: panels

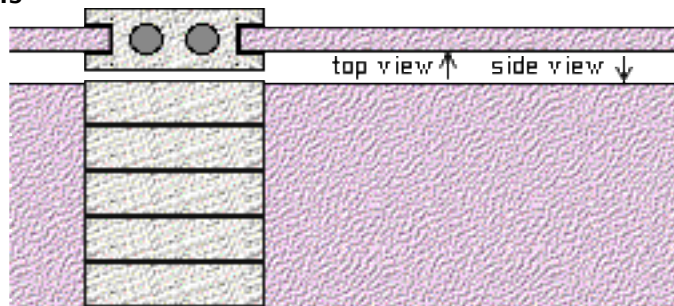

Panels, whether of concrete or made in the same moon dust sintering fashion as bricks and blocks, could be held in place by Lego type blocks with forked ends.

Such panel walls could be used to shade stored items that need to be kept within specific temperature ranges, as mentioned above. They can also be used as visual barriers along roads and paths, blocking the view of warehousing and recycling sites, for example.

### From Romance to the Prosaic

We must be brutally honest and say that we see no construction role for bricks in creating lunar shelter other than as retaining walls for moon dust shielding

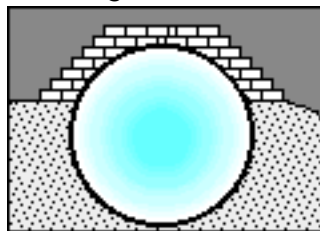

However, this form of shielding can only be constructed after the habitat module is in place.

However, there is one way to create a brick/block shelter before any pressurized modules arrive from Earth. That would be to use blocks designed for arches. You could build interlocking rows of arches over a temporary supporting inflatable structure.

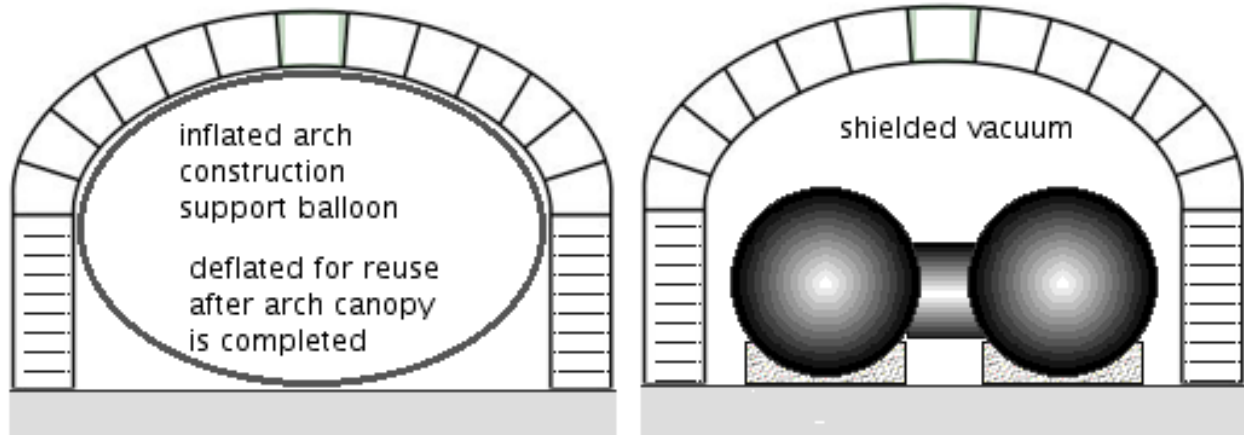

Should the Apollo Village proposal of presenting NASA with ready-made shelters is unrealistic, we can help to prepare a site for NASA by creating a supply of bricks/blocks which could come in handy in many ways.

#### **What about sandbags?**

As implied, we could also create piles of ready-to-use sandbags. It would boost the viability of this option, however, if we could make the “bag” from local material: glass or basalt fiber mesh. But a lot of prior experimentation will be needed to demonstrate that this can be done early on, on the Moon.

#### **What about pressurized buildings?**

Except for the unpressurized arched canopy option, even if we can't put up brick buildings, ready for NASA or anyone other agency to use, it is clear that we can provide brick, block, paver, and panel structures that will go a long way to making the job of setting up shop on the Moon that much easier. And this would go a long way towards serving the same purposes as The Apollo Village Proposal has been designed to do.

#### **Who gets to teleoperate the brick making, and deployment controls?**

Such a project, coordinated with NASA or any other contracting tenant, would be an early indication that a base was about to become real. Indeed, we think that we can make this proposal even more interesting by expanding on the teleoperation angle. Finding ways to select individuals from the public at large by lottery or other means and give them a turn behind the brick/block manufacture and deployment teleoperation controls, would give this project significant public attention.

We'd have to train lottery winners, and they would only get a chance to do actual work on the Moon remotely, if they demonstrated a required level of expertise. But to win and then be approved for this privilege would and then actually get to do some of the work on the Moon would be a lifetime feat hard to surpass, surely something to tell the grandchildren about.

#### **While waiting for NASA, we can do more!**

The Apollo Village Proposal suggests that space enthusiasts raise a million dollars or so for a publicity campaign that would get NASA to put in the budget the money needed to deliver the required equipment to the Moon. I think that misses major opportunities.

Why wait for NASA to do the brick and block design, to develop the equipment needed and which is to be teleoperated? Can't we help do that? NASA now has college and university groups help ferret our design options by such means as Rover competitions, regolith-moving competitions, and so on. It would seem that the next step, is not to raise money for a publicity campaign, but to get NASA to sponsor a new set of Engineering Challenges. This would involve many young people across the country in brainstorming how, indeed, we could do something like this: manufacture bricks, blocks, pavers, panels etc. on the Moon, ready for NASA or whomever to use. The moondust handling equipment as well as the manufacturing equipment needs to be pre-engineered and tested.

This would include tests using regolith moon dust simulant to see what process would work best and require the least weight of equipment and the least energy to produce the bricks and blocks. The proposal suggests using solar concentrators to melt moondust in molds. But sintering moondust compacted in molds by using microwaves could work if the product performance is sufficient.

While we could expect college and university teams to be eager to get involved, NSS chapters and chapters of other space organizations should be allowed to try their talents. What more captivating an activity could one imagine for chapter public outreach? Of course, most chapters would be hard pressed to put together a team with sufficient talents, and to purchase necessary supplies and equipment. But let's give them the chance!

**A dedicated website for this project would showcase:**

- ✓ Product design and service purpose options
- ✓ Equipment design and performance
- ✓ Progress along related lines such as design of sandbags, which could be made on site of lunar materials, and automated/teleoperated sandbagging equipment
- ✓ Illustrations and artwork
- ✓ Photo gallery
- ✓ List of college/university teams involved
- ✓ List of other teams (chapter-based, etc.)
- ✓ Information about related NASA Challenge events
- ✓ Updates on Moonbase plans of various agencies

The Moon Society could host such a site, but the National Space Society could do so also. Meanwhile, progress could be showcased at the annual International Space Development Conferences, and any demonstrations would be sure to attract a crowd. This activity could be a welcome added draw for the ISDC.

**Can we push this idea further?**

We do not now know where the first moon base will be located, or at least a few of us not on the bandwagon do not know. The South Pole location is very hilly and rugged and a builder's challenge. A site on or near a mare/highland coast would allow us to similarly pre-manufacture cast and/or hewn basalt products (from tiles to blocks) as well. A site which had flat areas for an initial base to morph into an industrial settlement, as well as nearby high ground for overlooks as well as scenic relief, would be visually more interesting.

Imagine that we find such a place, and prior to first base module landing, prepare the site not just by grading it and building a launch pad, but by tele-manufacturing bricks, blocks, pavers, panels, etc. for multiple helpful uses. Then, while waiting for the base components themselves to arrive, we tele-construct a "nature trail" to and up on any overlooking high ground. Our bricks, blocks, pavers, and panels could be used to make steps, restraining walls too near any precipices, benches to rest on along the way, and a paved, walled overlook on top with the panorama of the ever growing base-into-settlement below.

If such a trail were tele-constructed before the first crews arrived, it would be a welcome after-work and free time diversion to check on the progress from an overlook like this. What could we do to make the first crews feel more welcome than to have such a "Jay Witner" trail ready for them?

In summary, even if the Apollo Village Proposal should prove to go too far, we think that the general idea of providing pre-construction building materials out of moon dust by teleoperation has great potential, both to speed up construction of an operational Moonbase and to excite the public beforehand.

And we thank Jay Witner for that!     **PK**

Supporting illustrations and photos

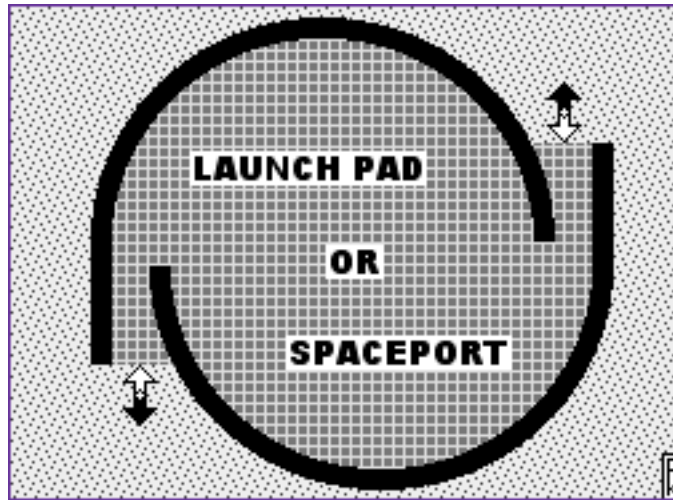

A Launchpad with paver floor and moondust berms between retaining walls

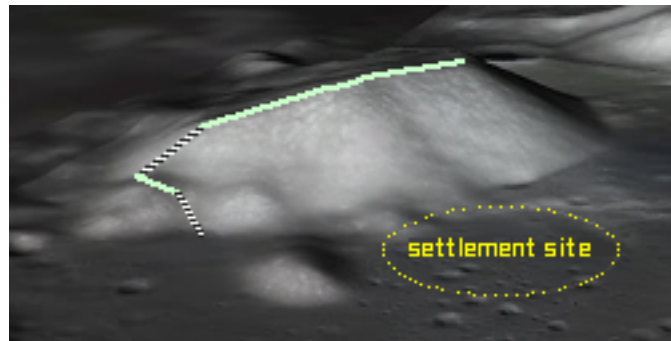
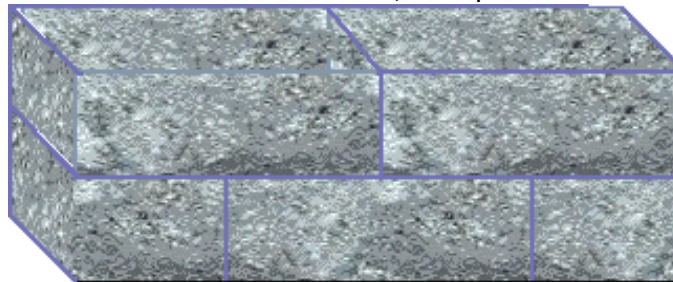

Illustration of overlook trail & settlement site below, over photo of Taurus-Littrow Valley (A-17)



Bench rest stop along the Overlook Trail



On the road from launch pad to the Settlement Site, paid for by a "Buy-a Brick" campaign, detail below.



J.B & Emily Armstrong	Tom & Judy Achtungler	
	John & Joanny Appleseed	Ella Mary Heidel

end

## **PETE'S SHIELDING BLOG**

By Peter Kokh [kokhmmmm@aol.com](mailto:kokhmmmm@aol.com)

Well, first, I don't like being called "Pete" unless you are about to give me money or treat me to dinner. And second, a blog is an online page airing personal opinions on a regular, if not daily basis. That said, "shielding" has been a favorite topic of mine since MMM #1 in December 1986, commenting on a May '85 visit to a unique "Earth-sheltered" (read "shielded") home some 25 miles north of my home in Milwaukee, Wisconsin.

I have a friend who refuses to talk to me about space because his teacher told him that it was not possible for humans to live on the Moon, and as he respected her, I had to be "talking nonsense." Of course, his teacher was right, literally speaking. No one can live "on" the Moon, not for long, given the thermal extremes, the total exposure to cosmic rays, solar flares, full industrial strength solar ultraviolet, and the micro-meteorite rain. Indeed, we can live "on" Earth's surface only because our thick atmosphere sufficiently insulates us from these aspects of the Cosmic Weather.

Our atmosphere serves as a blanket. There would seem to be no such air blanket protecting the Moon's surface. But take another look! The bombardment of the Moon's surface by big objects (most of that stopped over 3 billion years ago) and smaller micrometeorites (still ongoing) has pulverized the upper layer of the Moon's surface, gardening it to a depth of 2-10 meters (~yards), thinner in the maria which are only 3 plus billion years old and formed after most of the early bombardment ran low on material, and thicker in the older highlands. We've all seen film and photos from the Apollo missions and are familiar with what the surface moon dust looks like. We call this layer the "regolith" - Greek for "rock powder."

The point is that tucking ourselves under this blanket would provide the same degree of protection that our atmosphere blanket gives us. Consider that if it got cold enough (very, very) to freeze out our atmosphere, it would settle out on the Earth's surface (and ice-covered ocean) as a layer of Oxygen and Nitrogen "snow" 15 ft or 5 meters deep - in the same ballpark, thickness wise!

Over the years we have written many articles about shielding and methods of providing it. Getting ready for ISDC 1998 here in Milwaukee, I made a model of a modular lunar homestead on a 36"x80" hollow core door base to exhibit at ISDC. It teaches many things:

- How to build shelters on the Moon by using building materials made from moon dust (metal alloy, glass composites, concrete, etc.) to make modules (on the illustrated pattern of PVC plumbing components - I used 4" sewer schedule and smaller PVC/CPVC parts) - to make homes of any size, with many design options.
- Covering our constructed shelters with 2-4 meters (~yards) of moon dust (I used sculpted layers of 3/4" Styrofoam)
- Each home has access to sunlight, and visual access to the moonscapes outside
- Each module has a wastewater system that treats toilet wastes while providing clean water, lots of vegetation and color, and sweet fresh air - "modular biospherics!"



- All homes are connected to a pressurized street system so that one can go anywhere in town without a spacesuit
- Bringing tools and factories, seeds and resourceful people from Earth; making most everything else locally

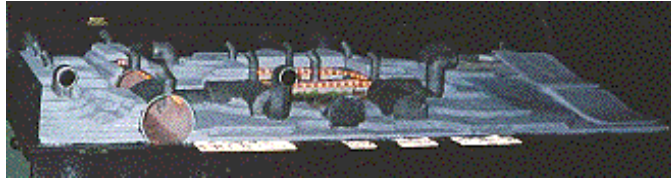

We are now in the process of making minor changes to this exhibit that we hope to bring to ISDC 2010 in Chicago next Memorial Day Weekend, so that it is more self-explanatory. I love explaining it to people whose eyes light up as they begin to understand how living “on” the Moon might be possible and quite comfortable – just by tucking ourselves under a moon dust blanket. Perhaps many space enthusiasts, who try to explain how we can set up shop on the Moon, neglect to put full emphasis due on “shielding.” That is perhaps the major root of the skepticism they encounter.

Meanwhile, back here on Earth, those of us who have seen or visited “Earth-sheltered” homes have had a preview. Now most such homes have an exposed south-facing window wall to tap passive solar heat, and that is something we can’t do that way on the Moon. The home I had visited back in 1985 did not have that feature and did break new ground on the methods of solar and visual access. See the article “MMM” is for “Mole” in MMM #1, online: [www.moonsociety.org/chapters/milwaukee/mmm/mmm\\_1.html](http://www.moonsociety.org/chapters/milwaukee/mmm/mmm_1.html)

#### Two images of Earthside precursors



**Terra Lux**, the home I had visited. Note exposed windows – upper portions of a unique periscopic system.



Necessarily exposed entrance to an “Earthbag” home  
<http://earthbagplans.wordpress.com/introduction/>

Also do Google Image searches for “Earthbag homes” – “Earth-sheltered homes” or “underground homes”

It is a mistake to neglect the shielding option and to tell people we will build in lavatubes. Yes, we will, and the possibilities are enormous, but not near-term, as lava tube construction will have its own challenges to address. Talk “shielding!” and you will convince more! PK

MMM #234 – April 2010

## **LUNAR BASALT**

### **What, Where, and its Critical Role for Lunar Industrialization and Settlement Construction**

By David Dietzler

With contributions from Peter Kokh

#### **1) Technical Terms and Chemical Description of “Basalt,” “Gabbro,” “Lava,” “Magma”**

Basalt is hardened surface “lava. Hardened subsurface lava is called gabbro. Molten surface rock is called lava and molten subsurface rock is called magma.

The lunar mare areas are covered with basalt pulverized into a fine powder by eons of meteoric bombardment. This material will be relatively easy to mine with power shovels.

This regolith consists of pyroxenes (iron, magnesium, and calcium silicates:  $\text{SiO}_3$ ), olivines (iron and magnesium silicates  $\text{Si}_2\text{O}_4$ ), ilmenite  $\text{FeTiO}_3$ , spinels and plagioclase  $\text{CaAl}_2\text{Si}_2\text{O}_8$ .

**Lunar basalts** are classified as high, low and very-low titanium basalts depending on ilmenite and Ti bearing spinel content. **They differ from their terrestrial counterparts** principally in their high iron contents, which range from about 17 to 22 wt% FeO. They also exhibit a range of titanium concentrations from less than 1 wt%  $\text{TiO}_2$  to 13 wt%  $\text{TiO}_2$ . A continuum of Ti concentrations exists with the highest Ti concentrations being least abundant. Lunar basalts differ from terrestrial basalts in that they show lots of shock metamorphism, are not as oxidized and lack hydration completely.

See: <http://en.wikipedia.org/wiki/Basalt>

Olivine contents range from 0% to 20%. Basalts from the mare edges or coasts probably contain more plagioclase, the mineral that makes up most of highland soils, than basalts closer to the center of the mare.

#### **Types of Processed Basalt**

- **Cast Basalt:** Basalt can be melted in solar furnaces, cast into many forms, and heated again and allowed to cool slowly (annealing) to recrystallize and strengthen the cast items. It can be cast in iron molds and possibly in simple sand molds dug into the surface of the Moon.

Iron could be obtained by harvesting meteoric Fe-Ni fines that compose up to 0.5% of the regolith with rovers equipped with magnetic extractors. Iron molds could be cast in high alumina cement molds. The high alumina cement could be obtained by roasting highland regolith in furnaces at 1800–2000 K to drive off silica and enrich CaO content. This could be hydrated in inflatable chambers with condensers to recover water vapor. It might also be cost effective to upport iron molds to the Moon since they would have a very long lifetime.

- **Sintered basalt** is not fully melted. It is placed in molds, pressed, and heated with microwaves or solar heat just long enough for the edges of the particles to fuse. This will

require less energy than casting. Sintered Basalt can be used for low-performance external building blocks, pavers, and other uses.

- **Drawn basalt fibers** are made by melting basalt and extruding it through platinum bushings.
- **Hewn basalt** is quarried from bedrock, road cuts, or lava tube walls. It can be cut with diamond wire saws.

## 2) Uses of Basalt: source:

[http://en.wikisource.org/wiki/Advanced\\_Automation\\_for\\_Space\\_Missions/Chapter\\_4.2.2](http://en.wikisource.org/wiki/Advanced_Automation_for_Space_Missions/Chapter_4.2.2)

Table 4.16 Lunar Factory Applications of Processed Basalt

### Cast Basalt - Industrial uses

- Machine base supports (lathes, milling machines)
- Furnace lining for resources extraction operations
- Large tool beds
- Crusher jaws
- Sidings
- Expendable ablative hull material (possibly composited with spun basalt)
- Track rails reinforced with iron prestressed in tension
- Railroad ties using prestressed internal rods made from iron
- Pylons reinforced with iron mesh and bars
- Heavy duty containers (planters) for "agricultural" use
- Radar dish or mirror frames
- Thermal rods or heat pipes housings
- Supports and backing for solar collectors
- Cold forming of Metal fabrication with heat shrink outer shell rolling surfaces

### [Current industrial uses omitted above]

- Abrasion-resistant Pipes and conduits
- Abrasion-resistant Conveyor material (pneumatic, hydraulic, sliding)
- Abrasion-resistant Linings for ball, tube or pug mills, flue ducts, ventilators, cyclers, drains, mixers, tanks, electrolyzers, and mineral dressing equipment
- Abrasion-resistant floor tiles and bricks

### Cast Basalt - commercial, agricultural, & residential uses (omitted on source list above)

- Large diameter (3" plus) pipe for water mains and for toilet and sewer drainage systems
- Floor tiles
- Countertops, tabletops, back splashes
- Planters and tubs of all sizes, flower pots
- Possibly contoured seating surfaces (contoured seats lessen the need for resilient padding, cushions)
- Lamp bases
- Many other commercial and domestic uses

### Sintered Basalt (from URL reference above)

- Nozzles
- Tubing
- Wire-drawing dies
- Ball bearings
- Wheels
- Low torque fasteners
- Studs
- Furniture and utensils
- Low load axles
- Scientific equipment, frames and yokes
- Light tools
- Light duty containers and flasks for laboratory use
- Pump housings
- Filters/partial plugs

**{Logical lunar uses omitted from above list}**

- Blocks for shielding retainer walls
- Slabs for airlock approaches, external paths and walks
- lightweight light-duty crates and boxes
- Acoustic insulation
- Thermal insulation
- Insulator for prevention of cold welding of metals
- Filler in sintered "soil" cement
- Packing material
- Electrical insulation
- "Case goods" furniture as we might use wood composites such as OSB, MDF, etc.

**Basalt Fiber – Uses (in place of glass fibers)**

- Cloth and bedding, pads and matts
- Resilient shock absorbing pads
- Acoustic insulation
- Thermal insulation
- Insulator for prevention of cold welding of metals
- Filler in sintered "soil" cement
- Fine springs
- Packing material
- Strainers or filters for industrial or agricultural use
- Electrical insulation
- Ropes for cables (with coatings)

[ In Gujarat at M .S. Univ., Kalabhavan, Baroda, basalt fibers are used as a reinforcing material for fabrics, having better physicomechanical properties than fiberglass, but significantly cheaper than carbon fiber.] [www.fibre2fashion.com/industry-article/3/256/new-reinforced-material1.asp](http://www.fibre2fashion.com/industry-article/3/256/new-reinforced-material1.asp)

- basalt brake pads? (no asbestos on the Moon)  
<http://www.technobasalt.com/news/?id=14>  
<http://www.basalt-tech.ru/en/prospects>

**Hewn Basalt** (MMM's list)

- Heavy duty Building blocks
- Road paving slabs
- Heavy duty floor slabs
- Architectural pillars, headers, arches
- <sup>a</sup> Carving blocks for sculpture statues, other artifacts
  - lamp bases, mancala/oware boards, etc.
  - fountains, bowls, table pedestals, vases, etc.
  - statues, plaques, beads, bracelets, endless list

**3) Properties of basalt** From-- <http://www.islandone.org/MMSG/aasm/AASM5C.html>

**Table 5.9.- Properties Of Cast Basalt**

Physical properties Average numerical value, MKS units

Density of magma @ 1473 K 2600–2700 kg/m<sup>3</sup>

Density of solid 2900–2960 kg/m<sup>3</sup>

Hygroscopicity 0.1%

Tensile strength 3.5X10<sup>7</sup> N/m<sup>2</sup>

Compressive strength 5.4X10<sup>8</sup> N/m<sup>2</sup>

Bending strength 4.5X10<sup>7</sup> N/m<sup>2</sup>

Modulus of elasticity (Young's modulus) 1.1X10<sup>11</sup> N/m<sup>2</sup>

Moh's hardness 8.5  
 Grinding hardness  $2.2 \times 10^5 \text{ m}^2/\text{m}^3$   
 Specific heat 840 J/kg K  
 Melting point 1400–1600 K  
 Heat of fusion  $4.2 \times 10^5 \text{ J/kg}$  (+/-30%)  
 Thermal conductivity 0.8 W/m K  
 Linear thermal expansion coefficient  
 ... 273–373 K  $7.7 \times 10^{-6} \text{ m/m K}$   
 ... 273–473 K  $8.6 \times 10^{-6} \text{ m/m K}$   
 Thermal shock resistance 150 K  
 Surface resistivity  $1.0 \times 10^{10} \text{ ohm-m}$   
 Internal resistivity  $1.0 \times 10^9 \text{ ohm-m}$   
 Basalt magma viscosity 102–105 N-sec/m<sup>2</sup>  
 Magma surface tension 0.27–0.35 N/m  
 Velocity of sound, in melt @ 1500 K 2300 m/sec (compression wave)  
 Velocity of sound, solid @ 1000 K 5700 m/sec (compression wave)  
 Resistivity of melt @ 1500 K  $1.0 \times 10^{-4} \text{ ohm-m}$  (author's note--this is of importance to magma electrolysis which requires an electrically conductive melt)  
 Thermal conductivity,  
 ... melt @ 1500 K 0.4–1.3 W/m K  
 ... solid @ STP 1.7–2.5 W/m K  
 Magnetic susceptibility  $0.1\text{--}4.0 \times 10^{-8} \text{ V/kg}$   
 Crystal growth rate  $0.02\text{--}6 \times 10^{-9} \text{ m/sec}$   
 Shear strength  $\sim 10^8 \text{ N/m}^2$

#### 4) Gallery of Basalt Products



#### Cast Basalt Pipes:

With unequalled abrasion-resistance, such pipes and chutes will be prerequisite for all moon dust handling industries, even for oxygen production.

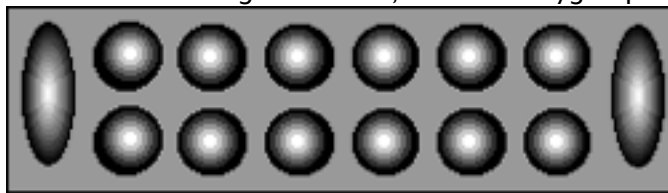



**A Mancala or Oware game board**



**Cast Basalt tiles (Czech Republic)**

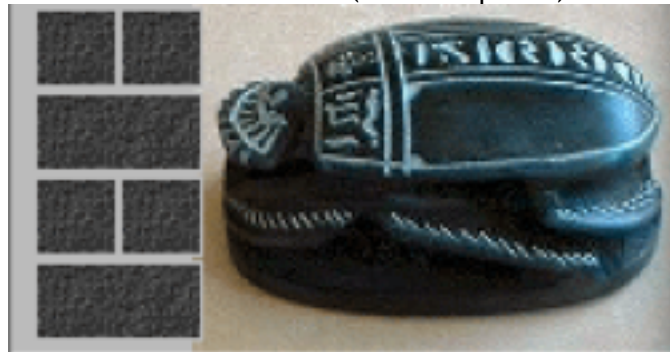

**blocks, carved scarab (made in Egypt)**



**Cast basalt planter**

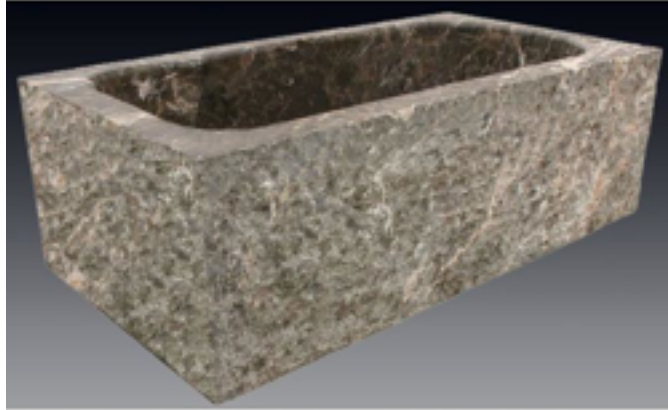

**A bathtub**

**Note:** The above are individually crafted items. Production items include pipes and tiles of various kinds.

## **Basalt: What Does All This Mean?**

By Peter Kokh and Dave Dietzler

The cute things such as what you can carve out of solid basalt, aside, the essential message is in the abrasion resistance of basalt vs. the very abrasive nature of moon dust out of which we are going to have to make as much as possible. The name of the game is to produce locally on the Moon as much as possible of local frontier needs, and to develop export markets for those things, to defray imports on the one hand, and to earn credits to import what they cannot produce on the other hand.

**Our Thesis:** A lunar basalt industry is **pre-requisite** to any other lunar materials industry. Unless we prefer to bring from Earth, all items needed to handle abrasive material such as moon dust,

### **Lunar industrial settlement must have access to basalt**

We believe that we must start in the maria, preferably along a mare/highland coast with access to both major suites of lunar material. The Lunar North Pole is some 600 miles from the nearest such coast – the north shore of Mare Frigoris. The Lunar South Pole is more than twice as far removed from the nearest such coast, the south shore of Mare Humorum.

Despite the advantage of more hours of sunlight, and eventually recoverable water ice, starting at either pole could be an industrial dead end.

Yes, access to water is essential, but most of us interested in lunar settlement, before the possibility of finding water ice at the pole became a common hope, were determined to launch lunar settlement anyway. We would harvest solar wind protons from the moon dust and combine them in fuel cells with oxygen coaxed from the same soil, to make water and extra power.

Having to do this, despite the now-confirmed reserves of water ice at the poles, may be a good thing, as it will prevent the rape of water-ice for the production of rocket fuel, and thereby preserve it for future lunar settlement needs including agriculture and biosphere. Yes Liquid Hydrogen and Liquid Oxygen are the most powerful fuels now in use. But 1) we don't need that much Isp to rocket off the Moon, or to hop from here to there on the Moon, and 2) we should be more concerned with developing more powerful fuels anyway, including nuclear fuels.

The polar water ice is at cryogenic temperatures, and extremely hard. Harvesting it in darkness at the bottom of steep crater walls will not be easy, and unless done entirely robotically, could be a very risky occupation. That it will be easy to harvest is myth #2. Myth #1 is that the sunlight at the poles is eternal. Honest estimates are that sunlight at any one spot is



available only 76% of the time at the South Pole, and possibly 86% of the time at the North Pole. That means for 52% of the nightspan at the South Pole and 72% at the North Pole. We must still bite the bullet and learn to store dayspan power for nightspan use for 100% of the nightspan, a factor of 2 times as long at worst. Then we can go anywhere, including places where a more complete suite of mineral assets are available, including possible gas deposits elsewhere.

The critical role of basalt is so fundamental to success that we must rethink our destinations.

DDz/PK

## MMM #239 – October 2010

A N

A V A T A R

M O O N B A S E ?

### Japan & Russia have Separate Ideas

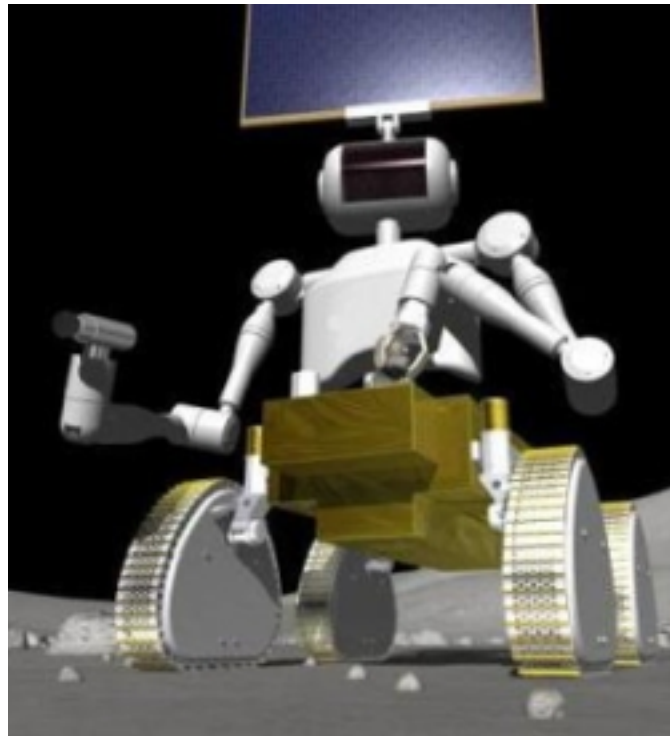

[http://news.cnet.com/8301-17938\\_105-20006075-1.html](http://news.cnet.com/8301-17938_105-20006075-1.html)

Above, a JAXA illustration from this report

By Peter Kokh

We have been talking for years about the need to automate and teleoperated as many “routine” tasks on the Moon as possible, in order to free humans on the scene to do what only they can do. Human labor on the Moon will be very expensive in terms of transportation logistics and life support. Workers on Earth, at the controls of teleoperation and telepresence devices will be considerably less expensive, and as they hand over the controls to relief personnel, the devices they control on the Moon can keep on doing their thing without relief.

Of course, there is a limit. Someone has to fix and maintain the teleoperated and telepresence-controlled devices on the Moon, and come to their assistance should they get stuck, or otherwise befuddled.

JAXA would go further, butting robotic avatars on the Moon that would allow scientists on Earth to see, pick up, and feel, and probe rock samples via telepresence. Humans would still be needed, and more of them than the devices they control, as they pass over the controls at shift rotations and for lunch breaks so that the work on the Moon can proceed “24/7.” Telepresence operators would experience what it is like to be and operate on the Moon’s surface, at least to some extent.

This kind of “takeover” may well happen for many occupations on Earth as well. No one will be laid off – they will just get to do their thing from the comfort of home or vacation settings. Less time spent traveling to and fro, less gasoline consumed. Of course, there will be some displacements. That is inevitable.

### **Background Reading: Some of these links include relevant videos**

<http://spectrum.ieee.org/robotics/industrial-robots/when-my-avatar-went-to-work/0>

<http://spectrum.ieee.org/static/telepresence>

<http://spectrum.ieee.org/automaton/robotics/industrial-robots/051810-anybots-qb-new-telepresence-robot>

Call this development “**teleoperation 2.0**” if you will. The upgrade is that your eyes will see what your avatar sees; your hands will feel what it feels. For the teleoperator, this will at first be a thrill, then frustrating, as one gets used to the 2.5-second time delay – light can only go so fast! – But in time all this will become second nature. We get used to “magic” very quickly.

While it may seem that less people get to go to the Moon, more people will get to enjoy the “avatar experience.” But as there is a limit to what can be done effectively and efficiently by telepresence, every task assumed by a telepresence operator on Earth, means that a human crew member is freed for non-routine things. We won’t be sending less people to the Moon, but the ones we send will get to do more exciting, less routine things. The upshot is that the same amount of humans on the Moon will get to do more interesting work, as the routine tasks will be teleoperated from Earth.

Now on Mars, telepresence type robotics will just not work, given the 6-minute minimum time delay (when Mars is closest to Earth) to a 40-min maximum, unless, of course, we have a forward base in Mars orbit: a space station or an outpost on one or both of Mars’ two mini-moons. But more on how we will do this on Mars in our next **Mars** issue (every **March**, of course), MMM # 243.

The Russians are planning a “robotic” moonbase as well. But this seems to involve teleoperated equipment only, tasked with base construction, and not telepresence tasked with scientific exploration.

### **Beyond Telepresence to “Droids”**

The next step is to make devices on the Moon autonomous, not only doing away with the time-delay, but substituting artificial intelligence for that of a tele-presence operator. But hopefully, Star Trek had it right, and the ‘droids will be tireless helpers, rather than replacements for humans. We can leave to them those tasks that are boringly routine, as well as those that involve substantial risk or danger, and or unpleasant operating conditions (the heat of high noon, and cold of nightspan; treacherous terrain, etc.)

One thing I can’t see, is droid replacements for my dogs! Or at least I hope to be long gone before that happens. I don’t mind my dogs owning me! Lol!

### **Site preparation tasks**

Current thinking sees involvement of robotic and teleoperated machinery for site preparation tasks such as spaceport construction, grading of the site, digging trenches to hold modules, then covering them with moon dust shielding, or with blocks made from moondust, etc. In short almost everything necessary will be taken care of by robots and/or teleoperated equipment so that when the first crew arrives, they have a ready-to-move-in outpost, and they can concentrate on scientific exploration and experimental production of building materials from moondust ingredients, needed to manufacture more living space for base expansion.

**MMM**

## **Telepresence-operated “Robonauts” will revise all “Scenarios”**

By Peter Kokh

At first impression, those of us who want to see human frontiers develop “and prosper” on the Moon, Mars, the asteroids and elsewhere in the Solar System may think that the emergence of robonauts threaten that dream. But quite the opposite is likely. These “stand ins” will pave the way at far less expense,

We have already integrated “teleoperation” of equipment” into our expectations. Japan and Russia, as well as our own Carnegie–Mellon robotics team, have suggested that site preparation and many construction chores could save substantial amounts of time and money. It costs a lot to put a human on the Moon! Humans are most effectively assigned to chores that cannot be teleoperated. Teleoperated equipment will allow humans to go to the Moon to begin at once to do what only they can do.

Enter the “robonauts” and telepresence! Here the human controller on Earth “sees what the robonaut sees, feels what the robonaut feels.” This is ideal for scientific tasks – for example, where it is not the size, shape or weight of a rock which is of interest, but its chemical–mineralogical makeup.” Robonauts can collect samples of special interest, freeing humans of that tedious chore, so that when they arrive, they can examine a pre–selected collection, without wasting hours and days in field work.

Robonauts do not need food, rest or relaxation. They can work around the clock, through a team of tele–presence operators on Earth. They do not get bored. Thus the quality of their work is more likely to be high. As to teleoperated equipment, there will be many chores which cannot be done into their manipulation tools, one of a kind chores, that could not be foreseen, or which will be so uncommon that it would not be cost–effective to further specialize those tools and programs. A robonaut with hands human–like in their degrees of motion, can use hand tools for a limitless list of special tasks. Robonauts can do things too dangerous or risky for human crews. T companions can relieve humans of all sorts of risky and tedious chores.

In his article “O’Neills High Frontier Revisited and Modified” blow, Dave Dietzler shows how the emergence of robotic technologies also radically changes that scenario of how solar power satellites will be produced and deployed. No need for hyper expensive Space Settlements, that could delay the construction of SPS systems by many decades. Humans will still be involved, in lesser numbers, with far lower thresholds of support.

To sum up, lunar resources are still a best bet to lower SPS construction and deployment costs, but the cost of accessing those resources will fall by an order of magnitude or more by reducing the amount of human workers involved.

Consider that a lunar settlement can begin very small and grow as needed, module by module. In Contrast, a Space Settlement has to be built to a set size, whether it is occupied by a starter crew, or at full capacity. Space Settlements have a built–in high threshold, greatly exacerbated by the insistence on Earth–normal gravity levels. PK

## **Role of Robonauts & Robots on the Moon Once Humans have settled in to stay**

By Peter Kokh

We have realized for a long time, at least since the early Apollo mission days, that radiation exposure on the Moon from cosmic rays and solar flares was a big problem. The week or so of unprotected vulnerability could be tolerated. But it would be better to provide some sort of shielding for persons intending to stay a while. Two meters of moondust overburden should protect those within habitat modules for stays up to a few months. But long term, 4–5 meters would be better.

We've known this for some time and most moon-base plans have some sort of shielding incorporated as part and parcel of the plan. This need has also made the possibility of locating human installations within lava tubes very appealing. These voids, whole networks of them, are common in the lava flow sheets that filled most large nearside basins, creating the maria (MAH-ri-a, singular MAH ray, mare) or "Seas." But these handy hollows are not to be found at or near either lunar pole, both poles being located in highland areas.

The inspiration out of which the original Moon Miners' Manifesto was born, was that while we had to live "underground", we would not have to live like moles, as Robert A. Heinlein had suggested in his classic novel: "The Moon is a Harsh Mistress," as there were ways we could take the sunshine and views "down under with us." [http://www.moonsociety.org/chapters/milwaukee/mmm/mmm\\_1.html](http://www.moonsociety.org/chapters/milwaukee/mmm/mmm_1.html)

But surely we have business out on the naked, radiation-washed surface! We need to explore, to prospect for minerals, to build roads, to trade with other settlements! No people, and surely not the Moon's people, will freely be virtually imprisoned full time. How do we handle this? Read on.

### **Radiation Exposure Limits and Monitoring**

Perhaps every Lunan settler or pioneer or visitor will be required to wear a wristband or other device that monitors one's accumulated radiation exposure. Those whose exposure is under set levels will be allowed to go "outside" - "out-vac" on the exposed, vacuum and radiation-washed surface for limited times, and on limited occasions.

### **Jobs and Careers**

There are those in any population that feel most at home "outdoors" and/or "on the road." But living such a life-style - having such an occupation, could result in radiation sickness and even premature death. Unless!

There are three ways to sidestep this nasty fate.

- (1) Outside jobs could be managed from the safety of shielded habitat spaces, by telepresence operation of robonauts or avatars.
- (2) The cabs of over-the-road trucks, motor coaches, trains and construction equipment could be jacketed by water (somehow kept from freezing or boiling). The jacket need cover only that portion exposed to the sky.
- 3) Outside jobs could be filled by rotation from among a large pool of persons, who would do safe "inside" work most of the time. This would not suit those who wish to be out on the surface regularly, but such types could work in jacketed conditions as described in (2) above.



We might expect to see some out-vac duties preferentially entrusted to robots and telepresence-controlled robonauts that can be put to work "24/7" without fatigue, boredom, and errors, and some to be filled by humans on restricted shifts, but from within the safety of shielded mobile cabs. Routine prospecting, mining, extensive construction, and road-building, are some of the high exposure activities that could be managed this way.

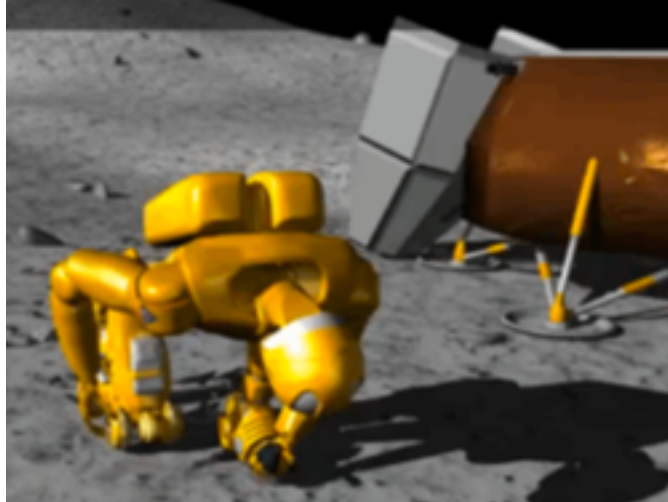

NASA-JSC Project M robonaut: ideal for prospecting / field science controlled from a shielded mobile unit.

Thus a truck cab could be shielded even if there were no need to shield the cargo containers. How is this different from human workers guiding deep sea well-drilling from the safety and comfort of a pressurized submersible at depths at which human divers could not work? Clearly, those who say we can't work out of our element, have already been proven wrong again and again. Wherever there is something to be gained, we will find a way to conduct our business safely.

Those who rarely travel by train or coach could ride in unshielded units at a bargain price, while businessmen who travel frequently could ride in shielded units at a first class rate. Common sense and a close watch of one's rem-exposure monitors, will allow most pioneers to enjoy an almost natural familiarity with the great lunar out-vac and with its magnificent desolation and spectacular sterile beauty.

### **Recreation and Sports**

In this situation, out-vac leisure activities such as rock collecting, hiking, road rallies, camping out under the stars, and prospecting for the fun of it, would have to be exercised with caution and sparingly. We won't become "Lunans" until we are "at home" on the Moon, and that means "at home" out on the surface as well as in cozy urban burrows. Even so, the availability of a mobile shelter when not actually engaging in the out-vac surface activity in question would make for good policy.

As to sports, the out-vac provides not only one-sixth gravity, but also vacuum, and pioneers will invent interesting and fun sports for such conditions. But here too, there is a way out: pioneers could build a shielded but unpressurized stadium (shown below) in which low-gravity vacuum sports could be played.

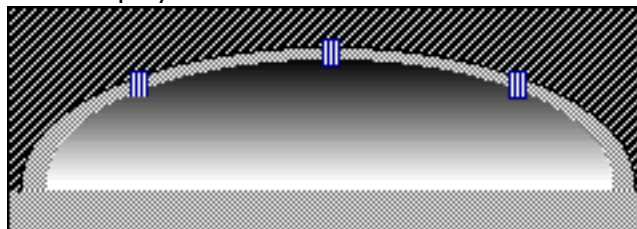

### **Are Demron-layer spacesuits be the answer?**

Recently, there have been a flurry of reports that a new polymer fabric offers sufficient radiation protection. But Wikipedia introduces its article with the following warning:

“This article is written like an advertisement. Please help rewrite this article from a neutral point of view. For blatant advertising that would require a fundamental rewrite to become encyclopedic, use {{db-spam}} to mark for speedy deletion. (June 2009)”

“**Demron** is a radiation-blocking fabric made by Radiation Shield Technologies. The material is said to have radiation protection similar to lead shielding, while being lightweight and flexible. The composition of Demron is proprietary, but is described as a non-toxic polymer. According to its manufacturer, while Demron shields the wearer from radiation alone, it can be coupled with different protective materials to block chemical and biological threats as well. Demron is roughly three to four times more expensive than a conventional lead apron, but can be treated like a normal fabric for cleaning, storage and disposal. More recent uses for Demron include certified first responder Hazmat suits as well as tactical vests. Demron is proven by the United States Department of Energy to significantly reduce high energy alpha and beta radiation, and reduce low energy gamma radiation. When several sheets of Demron are laminated together the result is a much more powerful shield, though Demron cannot completely block all gamma radiation.”

There is an enormous difference between the kind of radiation hazards found here on Earth such as exposure to radioactive wastes from nuclear power plants and exposure to high-energy cosmic rays coming from all directions of the space or the lunar sky.

In MMM #238 Sept 2010, pp. 4-5, “A Fresh Look at the Spacesuit Concept” we suggested a two-garment approach: an inner “skinsuit” counterpressure suit, and a loose outer suit to handle thermal exposure and provide puncture proofing. Perhaps a Demron layer incorporated into such an outer suit would allow the wearer to stay out on the surface a longer time before accumulating “x” amount of radiation dosage. But Demron has not been tested in realistic space conditions in Earth-orbit much less beyond the Van Allen Belts. It may or may not help, but certainly won’t be a cure-all.

### **A lesson some have not learned**

At the 2010 International Space Development Conference held in Chicago last May, a speaker confident of what he was saying, crossed off Moon and Mars as future settlement territory on the grounds of surface radiation exposure “unless we wanted to live under-ground full-time.” Nonsense. If there is one thing the history of the human Diaspora beyond Africa, and even within it, has amply demonstrated, it is that resourceful, ingenious, and determined people can learn to make themselves “at home” and comfortably so, in the most seemingly inhospitable environments. Settlers on Moon and Mars will defy the warnings of such persons, even as have the Eskimo and Inuit of our Arctic regions. “Where there is a will, there’s a way. And we will find ways to survive in environments much more unforgiving and hostile than Moon and Mars.

On frontier after frontier, we have been faced with new climate conditions, new geological and mineral resources, new plant and animal species. Where old tools did not work, or work well, we forged new ones that did. True, some frontiers would not support large populations. But everywhere, people have learned to live happy and productive and fulfilling lives.

Radiation will be a problem for those living and working on the Moon or Mars only until we have learned to deal with it “as if by second nature.” Sure Arctic and Antarctic temperatures can kill! But who would go outdoors in those places without adequate clothing and protection!

Lunan pioneers will soon learn what they can and can’t do in their challenging environments. More, they will continue to find new ways to push “this envelope” ever further and further, to the point few would see surface radiation as a game-stopper. Doing the right thing, the safe thing, will have become second nature. The pioneers will have become Lunans. And the same transition will occur on Mars and other even more challenging locations.

Take anyone “as they are” off the streets of Mumbai or Cairo and set them down in Antarctica, and we have a problem. But someone from Edmonton or Irkutsk might fare better.

Unlike specialized animal species, humans cannot be defined by their habitat. We are adaptable, and neither the Moon nor Mars defines the limits of that adaptability. We will learn to handle the risks of the lunar surface “as if by second nature” under penalty of death, just as the Inuit have adapted to the Arctic. We will not be at home on the Moon until we do.

To coin a word, we are a **prokalo-trophic** species: **we feed on challenges**. And those who warn us that we “can’t” do this or can’t do that, do us all a favor, by spurring us on to prove them quite wrong. And in that sense, science-fiction stories, which can get pretty wild, do us a service. They make us, even if only some of us, confident and determined to spread the human ecumene – the human ecosphere – beyond the four corners of Earth, beyond the seven continents and the seven seas, to wherever our ingenious heavenly chariots will take us.

The Moon, as a humanized world, will become more interesting and nourishing a life-environment because we have accepted radiation-protection as a challenge. The more formidable the challenge, the sweeter the victory! We would still be in the caves or swinging from the trees if it were not so.

So thanks for the warning. “Bring it on!” **PK**

## MMM #258 – SEPTEMBER 2012

### **Moon and Mars Outposts: Building Sheltering Structures First**

By Peter Kokh

Apollo left no occupyable structure on the Moon. There is no ‘friendly’ place to return to, no place where we can go and pick up where we left off. We must start over, from scratch, this time with a plan!

#### **We can’t “do the Moon” so long as we fear the Night(span)**

All six Apollo Moon landing missions were confined to the early/mid-morning “hours” of lunar dayspans. NASA has never attempted to keep astronauts on the Moon for a full dayspan-nightspan cycle, much less for several of them. Given that deliberate “toe-in-the-water self-limitation, the new rounds of astronauts only being on the Moon for less than two weeks before coming home, there is no urgent need to provide shielding.

However, for longer missions, as essential as shielding is for radiation protection, it will also be essential for thermal management in the month (“sunth”) long temperature cycle from 200° plus above zero to 200° plus below zero. Now, choosing polar sites or sites at high latitudes, north or south, would mitigate the problem. But consider an alien species visiting Earth and choosing a Pacific Island where the temperature varied very little over the year, radioing home, “we have mastered living on Earth.” Yes the polar sites offer access to water ice, yes they are more thermally benign, yes there is less difference between nightspan and dayspan, but the poles are anything but characteristic of the Moon at large, and do not offer critical access to mineral resources found only in the Maria, or along Highland/Mare “coasts” which means limiting ourselves to parts of the Moon we can explore, but more importantly, limiting ourselves to what lunar resources we can develop to fuel the Earth-Moon Cis-Lunar Economy.

#### **The Two Faces of Shelter**

The key is providing shelter, not only from cosmic and solar radiation over extended stays, but also to provide thermal moderation at comfortable temperatures. We would want to “shelter” our living spaces to provide moderate temperatures without energy-intensive heating and cooling even if there were no such thing as solar flares, coronal mass ejections, and cosmic radiation!

#### **How to Shield**



Considering the source of the author's original "eureka" moment in May of 1985 (read: [http://www.moonsociety.org/chapters/milwaukee/mmm/mmm\\_1.html](http://www.moonsociety.org/chapters/milwaukee/mmm/mmm_1.html) ) it is natural that I have long visualized an ever growing complex of interconnected habitat and activity modules and pressurized hallways, and as whole "neighborhoods" emerged, pressurized streets – all individually covered with shielding as they were added.

### Exercising due foresight

But, whether we are talking about a one-nation effort or about an International Lunar Research Park for the first "permanent" outpost, **it is likely that we will want to rearrange modules and hallways etc. as the complex slowly grows** and as experience suggests more favorable layouts. **Watch this time lapse animation video of the construction of the International Space Station, during which several modules were disconnected and repositioned elsewhere.**

<http://www.youtube.com/watch?v=h8kOArNNAo>

This flexibility will be needed in building a full-function lunar outpost as well. The original plan for expansion may end up being scrapped, and probably more than once. The way McMurdo Station in Antarctica grew to its present size is a case in point. Early expansion plans proved quite inadequate to provide needed expansion not only in the physical complex but in the variety of activities supported.

Thus **it would be best not to start with a few modules**, shielding them as added. For when we wanted to rearrange the complex layout, we would have to remove some of that shielding. Even if we had used sandbags, this would be a chore. There is another way: **Build an expandable shielded canopy first, before delivering modules** to park and interconnect in a temporary arrangement underneath.

### Canopies, Hangers, "Ramadas"

A word frequently found in MMM is "ramada." I first learned the word driving through the American southwest in 1980, long before the first MMM. At roadsides where tired drivers can pull in and rest, eat a lunch they brought along, and perhaps use the restrooms, there is often a roof supported by four poles at each corner, its main function being to provide shade from the hot unrelenting sun, rather than shelter from infrequent rains. This shelter is called a "ramada" – Spanish for sun shelter.



**Above left:** a traditional "ramada" sun-shelter in the SW United States



**Right:** a quonset type shelter

On the Moon, we will want unpressurized shelters of various types that are shielded from all directions. That doesn't mean "closed." Openings through which to bring in modules and other things to be deployed or stored inside can be baffled to block direct paths for solar or cosmic radiation to enter.

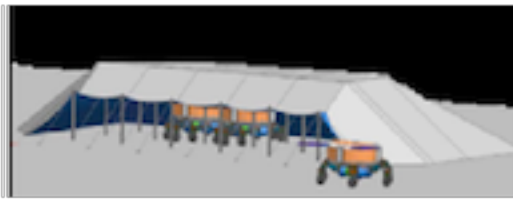
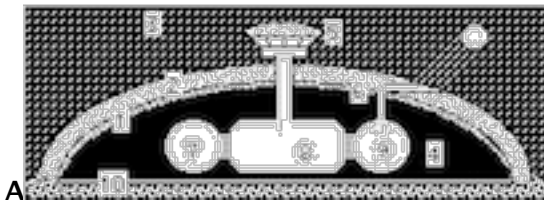

**Above left:** an illustration from MMM; **Above right:** a similar NASA concept

**Above left:** KEY: (1) Space Frame Arch, Fabric Cover; (2) 20 cm or more regolith dust shielding; (3) exposed vacuum, radiation, micro-meteorites, UV, solar flares; (4) protected lee vacuum service area; (5) observation cupola with ladder shaft to habitat space below (7, 8, 9)

### Two ways to deploy such a shelter “first”

1. We can send small crews to the Moon, living inside their lander, and working outside to assemble a suitable shelter. That would take several very expensive missions.
2. Or we can deliver **teleoperable equipment** to fabricate useful building elements from moon dust, and do some pre-assembly chores including producing sintered **building blocks in the “Lego” design** for self stacking without mortar, producing sand bags (basalt fiber fabrics if the site is in a mare area) and filling them

### Sintered blocks of compacted moon dust in “Lego” block shapes for mortarless assembly

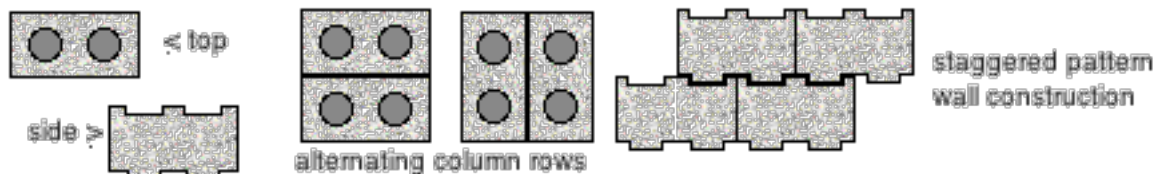

- “intelligent” “avatar” robots operated by “telepresence” from Earth, to handle some of the harder routine tasks, including leveling the area, assembling support walls from sintered blocks, piling up and bags
- **cargo container structures designed to be reusable**, for example with an unrollable wall for “roofing.” **Keep in mind that there are at least two ways to reuse a rocket stage:** a) **refuel it** for another trip or b) **reuse the materials** of which it is made to help construct things needed at the landing location.

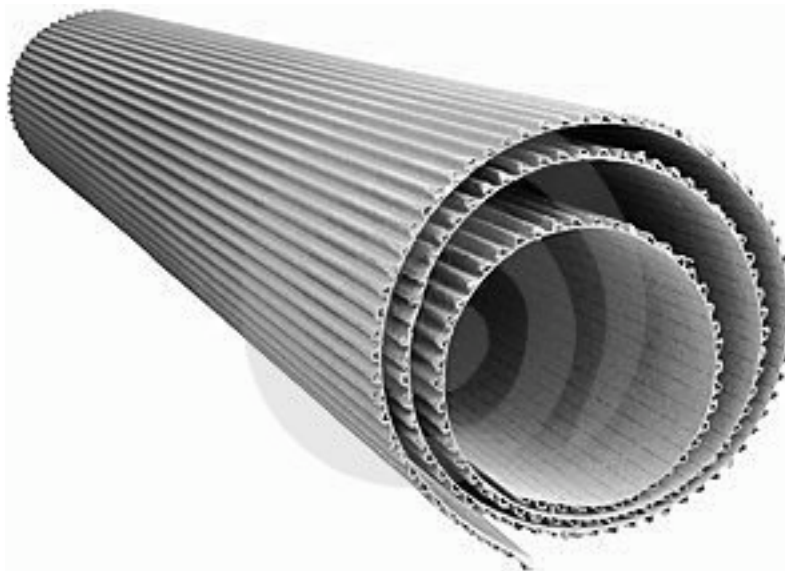

**Above:** a roll of corrugated cardboard suggests how the **corrugated aluminum skin of a landing cargo stage** (or empty fuel tank) could be reused as a roof to hold blown or bagged moon dust, with sintered lego block columns spaced to support the load in 1/6 G. If it proved too difficult to manufacture basalt fiber fabrics for bagging moon dust to cover a space frame to create roofing, such fabric could be part of the cargo in this shipment.

The corrugation will strengthen this structure in at least one direction. A 2-layer cross-corrugated sheet could not be rolled. But it could be designed to unroll in an arc, short of flat,

to provide strong support, the low ends resting on block walls and/or pillars, providing extra internal height.

An option would be two layers of material, placed so that the corrugation of one is at 90° to the other, making a very strong flat roof. (It is cross-grain plies that give plywood its strength and dimensional stability.)

**Question:** Could Cargo Hold wall unroll into a stable quonset structure? The arched hold wall roof supported in the middle would be stronger than a flat one supported at the sides. If the corrugated cargo hold wall was designed so that it could not unroll completely but retained a shallow curve, it might be strong enough to hold considerable shielding mass in light lunar gravity.

This type of pre-made reusable roofing, would seem superior, if practical, to constructing a space frame that would then have to be covered with some sort of sheeting (aluminum? basalt-fiber fabric made on the Moon). Both avenues should be pursued to expose and rank all the options.

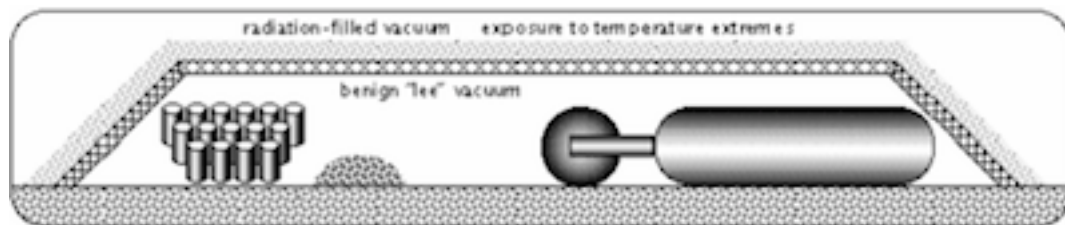

An earlier MMM Illustration: A hangar with “space frame” wall/roof construction requires sheeting to support moondust, Note warehousing area to the right.

The Advantages of pre-constructing a shielded hangar or ramada before first human crews arrive are clear: Each crew could simply park the modules brought along on its mission and connect them. The assembly area would be shielded, and the construction crew could wear lighter “pressure suits.” If a following crew brought more modules that required rearrangement of what was already in place, this would be easy, with no contact shielding materials to be removed and then repositioned.

Of course, sintered moondust lego blocks, basalt-fiber sandbags, sandbag filling equipment, and the ramada/hangar itself are not the only job that can be done beforehand. Teleoperable equipment can grade a landing site “spaceport” and compact and sinter the soil, and build berms around the site to contain rocket exhaust-blown moondust, which can be quite abrasive. And of course, the could level the area in which the hangar/ramada is to be built, and build some peripheral roads.

Open warehousing areas can also be pre-constructed, the ground leveled and sintered, the perimeter baffled by berms, sand bag walls, or lego-block walls, for items that can be stored unsheltered. The hangar/ramada should offer a limited amount of sheltered space for storing items best not exposed to extremes of heat and cold, as well as those that needed to be accessed frequently.

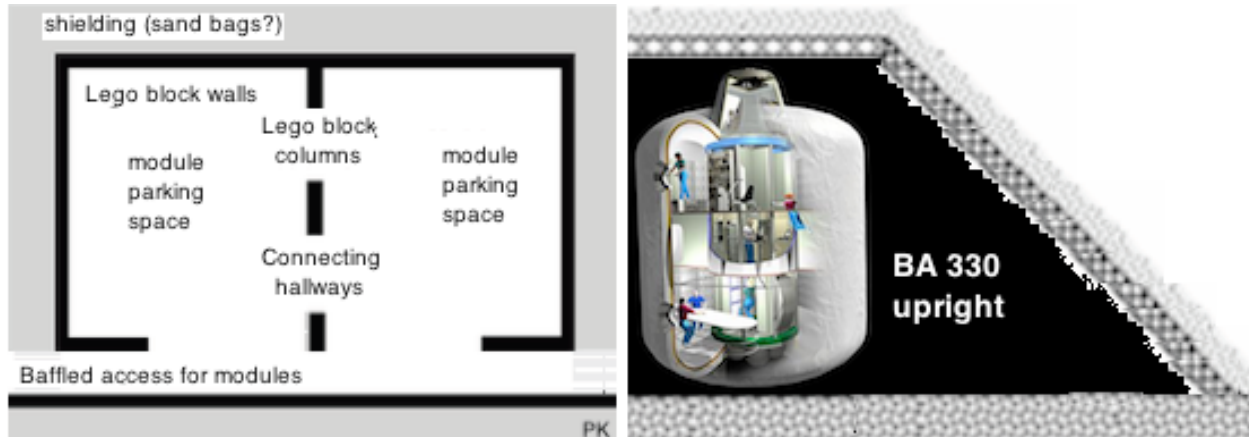

**Illustration of the shielded ramada/hangar concept:** Note that a shielded hanger could shelter upright BA 330 modules, difficult to shield otherwise. The vertical orientation offers maximum floor space. e!

**ISRU (on location resource use) items that need research now:**

- Basalt-fiber technology is advancing quickly: can we make sand bags from such a material? What about sheeting strong enough to hold several feet (minimum 2 meters) of blown moondust?
- Automated sandbag manufacturing
- Automated production of sintered regolith lego blocks of standard size
- Automated or teleoperated lego block wall stacking/construction
- Dompacting roller wheels (think steam roller size) shipped hollow, filled with compacted regolith

**You can help!**

Perhaps you can help fill in what we have missed or not thought of! Why not conduct local, regional, national, international engineering design contests to develop the ideas above.

**The Good and the Bad of the above scenario for outpost establishment**

On the one hand, **very expensive on-location manpower** is reserved only for those things that cannot be done by teleoperated equipment or by telepresence-operated avatar robots. This also decreases the chances of serious injuries. Further, when the first crew arrives, and parks the modules they brought along or which have been pre-landed within the hangar/ramada structures, they will be ready to stay several lunar cycles, i.e. in ISS type length crew stints, for which 2 meters of pre-provided shielding will be ample.

**Another conceptual illustration:**

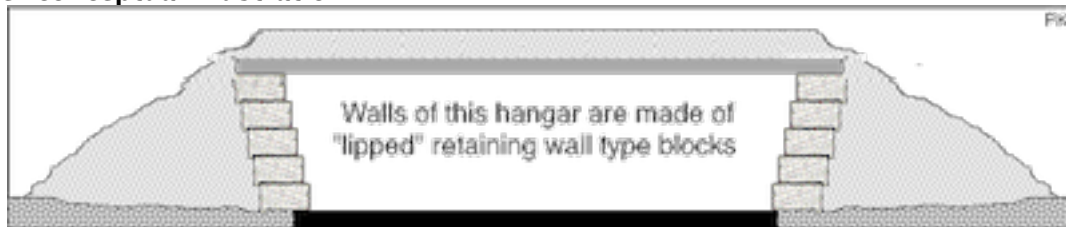

**Beyond bricks: pavers and panels**

Closely related to bricks are “pavers” which can be brick like in size and thickness up to much bigger slabs. These would have a use as well, for example serving as pavement for rocket landing/launch pads to cut down on the spray of sandblasting moondust driven by rocket exhaust. Such pads would be bermed as well to present a horizontal barrier; and these berms could well be confined between retaining walls.



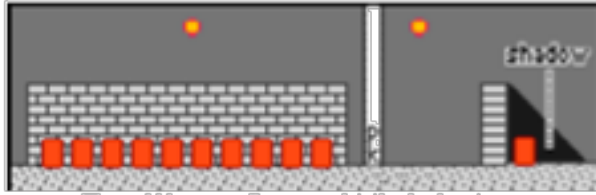

East-West walls, at middle latitudes provide shade for stored drums etc.

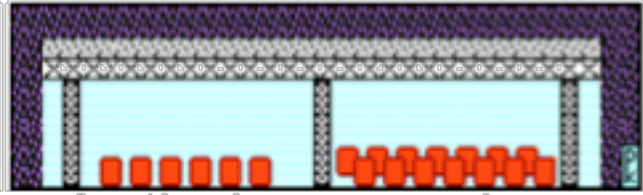

Stored items have greater protection under a shielded ramada-hangar canopy

Panels, whether of concrete or made in the same moon dust sintering fashion as bricks and blocks, could be held in place by Lego type blocks with forked ends. Panels, whether of concrete or made in the same moon dust sintering fashion as bricks and blocks, could be held in place by Lego type blocks with forked ends.

The hangar interior can be **naturally lit**, during dayspan, by providing intermittent broken-path sun-wells or direct path "sundowns" made of bundled optic fibers that double as shielding. Electric lighting for nightspan can be separately suspended from the ceiling or placed above the exterior surface, to use the in-place sun-well or sun-dow light delivery system. A light pipe network suspended from the ceiling could be fed by sulfur lamps.

**Visual access** can be accommodated by broken-path (radiation-proofed) mirrored shafts from the habitat modules underneath through the hangar roof. With proper planning, such ready-access observation ports can be provided ahead of time as the hangar is expanded section by section. Alternately, a pressurized vertical ladder-shaft can lead from habitat below to pressurized observation dome on the hangar roof.

**Who gets to teleoperate the brick making and deployment controls?**

Such a project, coordinated with NASA or any other contracting tenant, would be an early indication that a base was about to become real. Indeed, we think that we can make this proposal even more interesting by expanding on the teleoperation angle. Finding ways to select individuals from the public at large by lottery of other means and give them a turn behind the brick/block manufacture and deployment teleoperation controls, would give this project significant public attention. The use of supervised students selected by lottery would be even better.

We'd have to train the lottery winners, and they would only get a chance to do actual work on the Moon remotely, if they demonstrated a required level of expertise. But to win and then be approved for this privilege and then actually get to do some of the work on the Moon would be a lifetime feat, something to tell the grandchildren.

**Afterthoughts: Blocks designed for arches:**

There is another way to create a brick/block shelter before any pressurized modules arrive from Earth. That would be to use blocks designed for arches. You could build interlocking rows of arches over a temporary supporting inflatable structure.

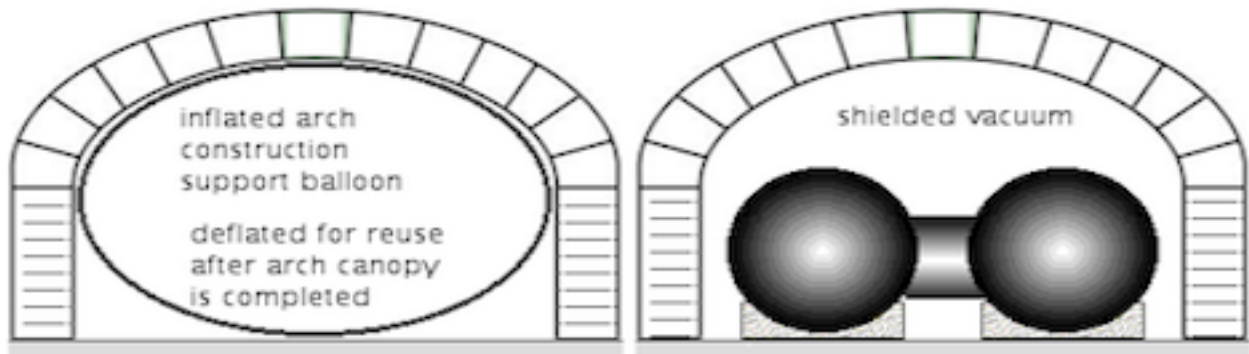

This slip-form sintered arch-block approach is well-developed in the paper "Lunar Base Design" by Peter Land of the Illinois Institute of Technology, pages 363-73, in "Lunar Bases and

Space Activities of the 21st Century”, Ed. W.W. Mendel, Lunar and Planetary Institute, Houston, 1984.

The ‘**ground**’ under the arch (the floor of the hangar) can be graded smooth, compacted and sintered to provide a relatively dust-free apron for the sheltered outpost. As we will see in a later article, “site management”, dust control, and good housekeeping habits must be in place from the gitgo if our attempt to establish an interface beachhead is not to fall flat on its face. (Inner and Outer “Yard” Managers or yardmasters will be critical job slots.) The hangar approach favors the early adoption and rigorous pursuit of good homesteading habits.

**Conclusion:** There would seem to be many options to providing ready to use shelter for the first crews before they arrive. We need to further brainstorm and pre-engineer each line to see which is the most problem free not only architecturally but with a view to teleoperated pre-construction, and to utility and versatility of use.

Which options could be further shielded to provide adequate protection for crews staying up to a year or more? If several sites are to be developed, and that is likely, then the most promising technologies should all be tested and tried, first on Earth if possible, then on the Moon. In time, a truly indigenous lunar-appropriate architecture will be developed and continue to be elaborated and refined.

The bottom line is the need to reserve expensively-supported crew hours on the Moon to those things that only crew on location can do. In time, the total pioneer population will grow more quickly, not less so, **because we have taken the time to do it right.**

We admit that the above ideas may not be appropriate for polar areas because basalt which we expect to play a crucial role in lunar industrialization is nowhere to be found. But it is time to get off “the Poles Only bandwagon.” We do need polar ice for water and fuel. But one of the most fundamental enabling technologies, cast basalt and basalt-fiber products require mare or highland/mare coastal siting that provides access to both major suites of moon dust materials. Those who are only interested in accessing the Moon for ice-derived fuels should keep developing their plans and scenarios. That said, the rest of us need to realize that water alone cannot help us transform the Moon into a new human pioneer world. The author’s recommendation? A site on the “northern shore” of Mare Frigoris, the Sea of Cold. Why?

- This places the outpost only about 200 mi (320 km) from the nearest ice-bearing craters to the North. The pole itself is some 600 mi (960 km) north. The nearest “shore” to the south pole is double that distance.
- This site has easy connections to the rest of the near side “mare-plex.”
- The Sinus Roris – Mare Frigoris plain stretches 150 degrees E-W. A power grid with solar stations along the route, would provide power for some 83% of the local nightspan, equalling the power coverage at the poles.
- Thorium-rich (nuclear power) and KREEP-rich (potassium, rare Earth elements, phosphorus) are to be found just to the South in Mare Imbrium.
- The Mare Frigoris area, at 60° +/- North, experiences substantially moderated dayspan temperatures.

### **Indirect Shielding Methods: Summing up**

Building a dust-shielded “hangar” that provides large unstructured “lee vacuum” space in which pressurized modules can be “parked” in various forms of interconnection, offers a much faster, and easier way to set up an open-ended expanding modular outpost. There is no shielding to remove when adding additional modules, nor any directly applied shielding to interfere with servicing and repair of system components on modules a.

As a bonus, there is extra radiation-free, UV-free, micrometeorite-free, and flare-proof unpressurized “lee” service space for storing tankage and other routinely needed, frequently tended equipment that does not need to be exposed to the sky. This allows wearing light-weight pressure suits for some exterior housekeeping chores.

The hangar shed makes sense if there is firm, review-proof **commitment to phased expansion** of the base beyond the original bare minimum habitat structure. For while its construction adds an original base-deployment “delaying” mission or two, the time-saving and effort-saving dividends down the road are considerable. If our commitment is scaled back to putting a toe in the water, rather than to “getting thoroughly wet” with a wholesale plunge, then, of course, the hangar will be seen as unnecessary. But then we have an Apollo “Flags & Footprints” “Kilroy was here” repeat, and for what? Anything that is worth doing is worth doing well, and doing right, so that it becomes the foundation of something greater and not a just a stunt that leads nowhere.

### **Providing ready to use shelter will be even more essential for Mars explorers**

Staying a year in orbit “within the van Allen Belts“ is not the same risk-wise as staying a year on the Moon, where radiation shielding is strongly recommended. It will be even more so for Mars outposts which include travel time to and fro at risk. Crews arriving on Mars will already have been exposed to maximum acceptable limits of radiation. They need to have usable shelter immediately upon landing., not months later! This will minimize the chances of serious construction accidents in a place where getting to a hospital can be months, even years away.

Teleoperation and telepresence operation of equipment and robot avatars on distant Mars will be exceedingly tedious because of the 6-40 minute time delays strictly enforced by the speed of light. It would be helpful first to create shelter under the surface of Phobos or Deimos for teleoperators and telepresence operators who could then direct construction of surface shelters almost anywhere on Mars other than at the poles, in near real time. Those whose impatience demands that they bypass the “PhD” accelerator, will hopefully give way to those of us, who like the tortoise, realize that the fastest way in the end, is the most deliberate and carefully thought out, and patient way to do anything.

Below is a well-intended but dangerously unshielded concept from **MarsOne.org** - <http://www.space.com/16300-mars-one-reality-show-colony.html> (video) **PK**



Join the Moon Society - <http://www.moonsociety.org/register/> and get access to all MMM issues, #s 145 forward, in pdf file format at: <http://www.moonsociety.org/members/mmm/>