

*"Expanding the Human Economy through Off-Planet Resources"*

# Moon Miners' Manifesto - pleiades

**MMM Classics**  
The First Fifteen Years

**Year 11: MMM #s101-110**  
December 1996 - November 1997

As usual, we talked about many topics this year. But again, as usual, some themes and topics came in for special treatment.

We continued the series of articles on exploring and using the expansive ready made sheltered lavatubes found in the lunar maria, talking about the "civilization & culture" that would arise if and when substantial numbers of Lunan pioneers settled "down under."

We continued the look at pioneer civilization & culture in "The Luna City Museum Visitors Guide - 2097" which takes a look at how pioneers will preserve and cherish relics of the early frontier days, how they will teach children, and themselves about the civilization & cultures they left behind on Earth, and about Earth's wildlife and enormous biodiversity.

For Nearsiders, at least, Earth will be hard to forget. It will hang in the sky full time, an ever changing spectacle of colors and patterns and phases. They'll see the continents pass by, shifting clouds and storms, the nightlights of great urban clusters, the signs of the changing seasons. No sky in the solar system will present a better spectacle!

But the Lunan pioneers will be only the first wave of an unending migration sketched by contributor John Camp. It will be only a matter of time before we humans are to be found in all the far corners of the solar system, and beyond! "Of stardust we are, and to the Stars we yearn to return!"

## **"Down Inside" Civilization & Culture** *The Luna City* **MUSEUM** *Visitors Guide - 2097*

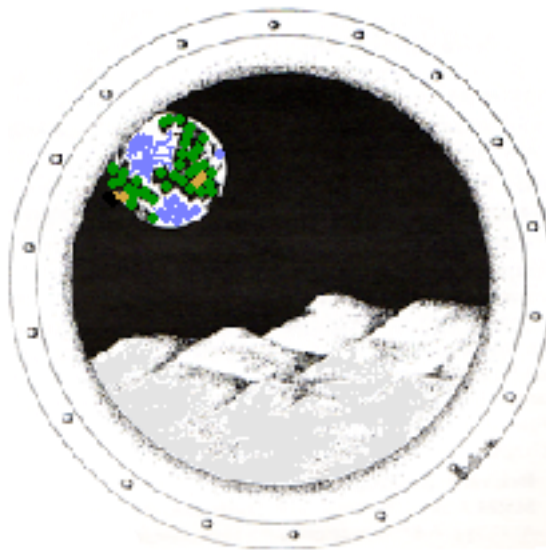

## *Luna City Streets*



But to get back to the very beginnings, we may first set up a Secure Quarantine Facility on the Moon for the first Mars-Sample returns (later for sample returns from Europa!) to make sure that the road for human expansion is biologically clear and safe. The Moon will play a major role in the opening of Mars, offering industrial assistance and seasoned frontier-tested settlers.

The Clementine Probe has found indications that the Moon's permanently shaded polar craters may harbor water-ice. We look into what is needed in the form of "ground-truth" missions, and into the logistical challenges of getting polar water to the industrial mid-section of the Moon.

Throughout the previous ten years, we have been sketching what the lunar frontier life might be like from various angles. Now we put all this together from a stressed vantage point in "Luna City Streets." We also touch on "reclamation" as the essence of the lunar settlement challenge.

The settlers in time will acquire autonomy and home rule, and we look at the roots of this paradigm shift.

Finally, we report on the second of a series of three brainstorming workshops on Europa. Will explorers there be able to "live off the ice" to paraphrase the usual saying? We try to sketch out the possibilities, aware that the evidence is still skimpier than we might wish. *Enjoy!*

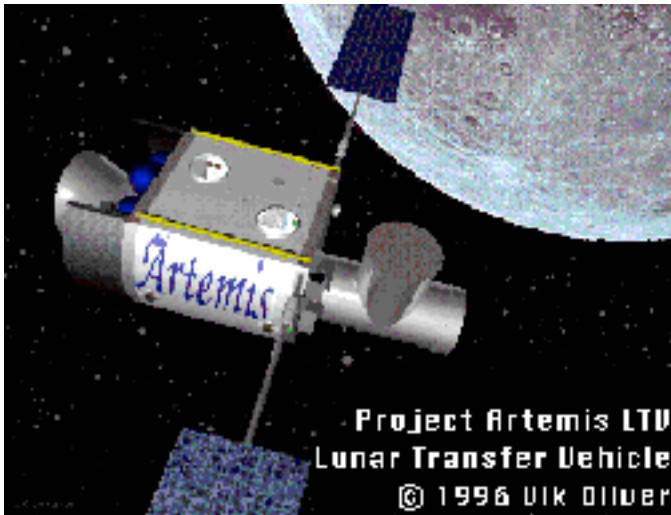

[<http://www.asi.org/images/asi199600079.gif>]

### “Landing Day” — and a Dream for MMM # 201

Spacecraft Engineer, principal architect of the Artemis Project™, Lunar Resources Co. CEO, and science fiction writer Gregory R. Bennett teams up with Shannon S. Yaeger of Hawkhaven Graphics to put together the fictionalized anticipation on pages 11-12 of this issue. In the last issue, cartoonist Dennis Cripps hinted at the other half of our dream for celebrating MMM’s 20th anniversary ten years from now - the editor putting together the final edit with his Mac laptop — *on the Moon!* If we each go beyond what complacent precedent justifies, it *can* happen.

Our 10th Anniversary Issue:  
A look back ... and forward

**IN FOCUS “Getting there is half the fun!”**  
**Ad Astra per Ardua - To the Stars through Hard Work**

#### Looking Back - The Past Ten Years

I remember the deep sense of satisfaction I had when I finished collating MMM #2. After all, a very high percentage of new newsletter and magazine starts never get beyond Vol. I, issue #1. Suddenly I’m putting the finishing touches on # 101!

Ten years! We’ve collectively seen a lot, and been through a lot. Pushing our dream, an open space frontier in which development of off Earth resources includes off planet settlement, has not been easy, smooth, guaranteed. Ours is not the role of cheer-leading spectators, and those who’ve joined our ranks for the bandwagon thrill of being aboard a surefire winning program with no setbacks have long since become disheartened and jumped ship. As have many of those who can’t see past all the irrelevant inside politics. As have those who have identified particular paths to the future as the only ones.

We began this venture, we founders of the Milwaukee Lunar Reclamation Society L5, back in the fall of 1986, little more than half a year after Challenger exploded, and with the real disaster of public and governmental reaction still

unfolding. It would be another two years before the next Shuttle flight. And already, in this interim of seeming inactivity, we were looking for alternatives and options. We talked about Dr. T.D. Lin’s concept of a 210,000 square foot lunar outpost made with 2 million tons of lunar regolith and lunar concrete (and 55 tons of imported hydrogen). We told our readers about the bold lunar real estate turnkey outpost development plans of Lady Base One’s Mitch Mitchell. We worked hard to get the proposed non-agency Lunar Polar Probe effort back on track and Lunar Prospector was born, put in suspended animation, and then revived to fly this coming year.

Reagan’s Space Station “Freedom”, not the von Braun/“2001” wheel we had all hoped for, promised room for four astronauts in space at \$8 billion per bed, got cut short to Space Station “Fred”, then “Fried”. Expecting Congress to deal the merciful coup de grace, we sat in on an ultrahigh level back room DC meeting to resurrect Station from its ashes, commercially. Clinton’s uncanny political wisdom found another way, redesigning Station around the Russian Mir II, selling it as a way to help keep afloat and on track a new democratic Russia. International Space Station Alpha’s high inclination orbit, a concession to the Russian-Kazakhi launch site at Baikonur, makes it that much less suitable as a staging base for deep space operations, guaranteeing that commercial stations will in fact come, and perhaps sooner than most think.

We cheered as Endeavor was built and flew as a replacement for Challenger. We cheered as it, and the other orbiters were outfitted and retrofitted for extended duration missions. And we were all greatly enheartened by the current Shuttle-Mir missions. The Shuttle was finally going somewhere! Yet there have been temporary setbacks: Hubble’s optical problem, the failed tether experiments, and more.

At first just a few of us, then more and more until it became consensus, saw that NASA’s Mother-hood-and-Apple-Pie Space Transportation System involved a radical misdirection of the agency’s purpose, that a 5th orbiter should not be built, that we had to privatize space transportation, that as marvelous a machine as the Shuttle was, Proxmire was right after all, when he predicted that rather than lowering per pound costs to orbit, this all purpose space pickup designed-by-committee would raise them. A replacement vehicle development program was announced: NASP, the National Aero-Space Plane. But it became a victim of its own price tag and many were disheartened.

Yet the rebellion to put a sunset limit on the Shuttle and begin work on a radically new workhorse calculated to usher in “Cheap Access To Space” had begun. It quickly won converts - not-so-amazingly becoming mainstream, given its irrefutable inner logic. The Shuttle was the door to space all right, a locked heavy door that no one but the government could afford to open. It defeated its own purpose.

We watched in minority horror as Bush announced the pop-heralded Space Exploration Initiative - in horror, we say, because by failing to list compelling reasons for a return to the Moon, and an opening to Mars, Bush delivered a proposal to Congress that was irretrievably Dead On Arrival.

Yet, while the absurd space opera of ultra expensive government space scenarios continued to play to the cheers of

diminishing audiences, a new prophet emerged with a visionary sketch of radically less expensive mission plans to the Moon as well as Mars, enabling direct Earth surface to lunar and Martian surface round trip flights, bypassing the dead end preemptively expensive station, with the simple common sense of the frontiersman pioneer - using local on site resources for refueling and resupply. Many quibble with the details of Robert Zubrin's breakthrough visions. Yet no one still seriously espouses the old *totally umbilical* mission philosophy. That is an enormous tribute to the power of Zubrin's new paradigms which continue to unfold.

MMM and MLRSL5 were born as the merger negotiations between the precursor L5 Society and the old National Space Institute were coming to a head and we became the first fully merged chapters three months *before* the documents were signed. The marriage has had its rocky moments as parts of the former two fought not to become one. In the struggle, many fell out, confusing the relative importance of goals and means. The merger was made to bring together the separate strengths of the two societies, but it was not without some unfortunate losses. Gaining a headquarters in Washington, where the "action" was (to those still convinced that private enterprise could only do little things, and still deluded that the government could find the needed political will), we lost the valuable vantage point that made vision "desert clear" in Tucson.

And we mourn still the fundamentally philosophical choice of preeminence of "national policy" over "frontier goals" institutionalized in the new name of the "National" Space Society by member choice (the other choice on the ballot was "The Space Frontier Society") We remain in the minority still.

We have watched as some organizations have gone under (Lady Base One, the Lunar Development Council, and others) and watched as others have been born to focus on special needs: Space Frontier Foundation, Space Access Society, The Millennial Foundation, Artemis Society International. This is very healthy and we applaud this diversity.

The road to an open space frontier is not a narrow one - it is unbelievably wide and multiversal, a goal with as many legitimate paths as there are individually talented and individually inspired people to pursue them. We decry those who, on an undeniably legitimate and vitally important path, make light and folly of all other efforts and preoccupations. The road to space is a dendritic one with many tributaries. The "space activist" is not just the supporter who takes direction well, opens his wallet, picks up his pen to write his Congress people, and makes long distance phone calls - all to push space as a governmental program. Space is more than that! It is a *human program*, and anyone who uses his or her talents - *whatever they are* -to further the fuller realization of the new era of breakout from Cradle Earth has the right to be respected as a "space activist". To the contrary, for the one whose only tool is a hammer, all problems look like nails. Those who decry the meaningfulness of the efforts of others, expose the emptiness of their own personal toolboxes. Indeed, we have watched as a totally new and unpredicted tool has risen to major importance: the Internet, the World Wide Web.

Meanwhile our own tool, MMM, is a modest one. Yet we have watched its circulation grow from an initial hundred (fattened by freebies) to some six hundred, reaching every continent but Africa and Antarctica, spreading beyond Milwaukee to ten other NSS chapters, and beyond service within NSS to service within Artemis Society International. MMM has grown from an initial ten pages to twenty four, and has never missed an issue. A disproportionate fount of its success has been the simple gitgo decision to publish ten months a year with a semiannual burnout-prevention and inspiration-renewal break.

MMM has been and continues to be a labor of love. We are not tired. And the well is far from dry. As we continue down the path to the future we will meet new obstacles, setbacks, trials, and uncertainties. Some will fall by the wayside. Yet we have been gratified by our continued very high 80% plus renewal rate, year after year. So thanks to all of you without whom it would not have been possible.

It has been encouraging, too, to hear many of the ideas first introduced in these pages echoing back from other speakers and writers. Attribution in this game means less, far less, than our success together as a fraternity determined to take mankind beyond its womb world, with no turning back.

Commerce and Private Enterprise still seem to us the only horses worth riding. Ridiculed as unable to do the job so far, they remain without alternative. *By nature*, governments subservient to consumers *cannot* ever muster the political will to do *what will always be beyond the majority vision*. What is popular is not necessarily right, and vice versa. If free enterprise cannot rise to the occasion, then, folks, it cannot be done at all. Nor confuse free enterprise with the contract-addicted major players.

With so many visions, all with some validity, it is inevitable that our movement has picked up a heavy burden of fellow travelers: those not interested in an open space frontier, the development of off planet resources, nor the establishment of viable off world pockets of humanity. Yet their lesser visions, of expanded Platonic knowledge of our solar system through robotic proxies, of expanded knowledge of our home planet through orbiting probes, and of other space-routed domestic home planet services - these visions, too, are each valid, however tragically limited. They and those taken up with them deserve our respect. In the process of fulfilling our vision, we *will* fulfill each of theirs - *beyond* their wildest dreams, and *despite* themselves.

### **Looking Ahead: The Next Ten Years**

In the coming decade, MMM hopes to see competitive enterprise take a much stronger role; to see the emphasis in planetary probes shift from increasing textbook knowledge to increasing our pragmatic knowledge of the resources available in Earth's off planet hinterland; and to see the dawn of effectively cheaper access to space.

There will continue to be detours. A plaque in my bedroom reads "the contented man is one who enjoys the scenery along the detours." That is not enough, however. We must always be on the lookout for the serendipitous along the way, the discovery of unsuspected better routes than the one whose cutoff we may have been bemoaning. If the optimist is a

ridiculous person, so is the pessimist. *Only the meliorist is not a fool*, the person who can accept the given and go on from there, change of direction after change of direction. "Reality", says the witticism, "is what happens to us while we are busy making other plans." It is a game that optimists and pessimists alike must lose, one only the meliorist can win.

MMM will continue steadfastly in this melioristic posture and we hope you will stay with us. Bad news is news we have yet to look at from the right perspective. With the right attitude, we will overshoot our goals. It's a temperament thing.

We've been passionate about man's "Destiny in Space" since we learned how to read - that's a long time ago, before the V-2s started buzzing London. By the time you read this, we'll have had to blow out 59 candles. But it's a personal go for another 25. We hope you keep us company.

Artemis Project™ architect Greg Bennett asked me how I planned to celebrate MMM issue #201. I replied "by finishing the master copy on the Moon, or emailing the text back from Luna, or reporting on Artemis Base *in Angus Bay*. Right now, I'm more concerned with issue # 102. One step at a time! PK



[Continuing last month's discussions on "the Lure of the Moon's Hidden Covered Valleys" — the Lavatubes]

# "Down Inside" Civilization & Culture

## Part II. Lavatube Culture

by Peter Kokh

That we can predict a substantial and marked difference in the maturing cultures of those Lunan settlers who live on the surface, snuggling up under their protective regolith blanket, from that of those who build their townsites within ready-to-occupy lavatubes, should be clear from the length of the list of their respective "transcendental worries".

<b>"Transcendental" Needs of Lunan Settlers</b>	
<b>surface sites</b>	<b>lavatube sites</b>
<ul style="list-style-type: none"> <li>• Shielding</li> <li>• Pressure Hull</li> <li>• Biosphere</li> </ul>	<ul style="list-style-type: none"> <li>• Pressure Hull</li> <li>• Biosphere</li> </ul>

Coddled by a womb world in which all these basic things are already provided, freeing us to concentrate all our worry-power on lesser if analogous concerns (weather, harvests, economics), it is not hard to see how much more squarely Lunans might feel themselves "behind the 8-ball" than Earth folk. It should also be clear that lavatube dwellers have a substantially reduced worry burden.

Shelter one can count on and take for granted against micrometeorites, against decompression accidents from meteorite debris, against cosmic rays, against the raw naked ultraviolet heat of the Sun, against Solar Flare temper tantrums - this bequest of the lavatube is bound to make its havened citizens a noticeably more carefree lot - even if only in a relative sense. To be sure, the two remaining "transcendental

worries" will still provide a strong bond between these two "branches" of Lunan culture.

Hopefully more in friendly jest than in contempt, those of either persuasion may take jabs at those of the other. Surface dwellers may call their cousins "tube toads", "cozies", "womb-retentives". In counterplay, lavatubers may call their surface relatives "mound moles", "dust eaters", and the like. One side or the other may retranslate the long litany of ethnic jokes, translated oft before (the very same jokes some tell of Poles, Poles tell of Russians, etc.). We can hope. such jibes will be more a symptom of friendly rivalry than a hint of unjust contempt.

On the other hand, in describing themselves, surface folk might call themselves "blanketeers" or "the star-sighted" or some other name which heralds the compensating glories of a life on or just under the surface. By the same token, tube folk might call themselves "down insiders" or "the sanctuaried" or by some other term that highlights the advantages they enjoy and appreciate.

### Being a "Tuber"

Settlers who live much of their lives within the lavatube environments may exhibit as a group, relatively speaking, a more "laid back" personality. They must still be much more alert to individual and communal danger and potential catastrophe than most terrestrials. (Granted many of us Earthlubbers relish in the nature-daring risks of living on active faults or on the slopes of active volcanoes or in the path of hurricanes etc.)

In addition to this somewhat more relaxed mien, tubers will employ different set of architectural solutions in building their homes and settlements [see last issue, pages 7-9 "Settling into a Lavatube"]. They will look out their windows on radically different underworld "moonscapes". They will tend to establish and preferentially use their own distinct "networks" with other outposts, settlements, industrial parks, farms, resorts, etc. "up" or "down" the line in the same tube, or in intersecting neighboring tubes (in comparison to the mainly overland connections between in-surface outposts).

Tubers, doing all the ordinary things to earn their individual and communal living as settlements elsewhere, will be further boosted in their sense of fulfillment by the very unique to their situation communal "vocation" of "archiving" [see below]. And finally they may feel a certain affinity with settlers in the geologically analogous lavatubes we expect to find on Mars, and elsewhere. All of these strongly distinguishing characteristics should work to give tubers a sense of special identity and fellowship.

Will they in fact identify themselves as "tubers", refer to their communities as "tube towns", and to their collective realm as "Tubedom"? Or will they call themselves lunar netherworlders, or underworlders, or selenospeles, or find some other set of words? That's up to them.

Surely they will publish their own magazines (<Lunar Tubes & Trails , Lunar Tubeways , Hidden Lavascapes>, or whatever.) These publications will share information about new tube-appropriate architectural and construction methods, about new Lavatube developments and recreations, about the developing culture and arts and crafts of nether-worlders, and

promote continued lavatube exploration in adjoining areas, lower levels, and new areas.

### **Ever “Remapping” the Moon**

It will be the tubers who keep publishing ever new editions of lunar maps. The surface having been well mapped for a long time, new selenographical discoveries will be predominantly those coming from discovery, surveying, and exploration of new lavatubes, of lavatube extensions and connections, of lower level tubes etc.

Nor will this be information relevant only to scholars. The expansion of the <Terra Habitabilis Cognita> (known habitable [= pre-shielded] land) on the Moon, the identification of natural <metropolitan complexes>, the growing square mile count of known usable tubes reserves — this will all have considerable economic significance.

Special legend maps will be color-coded to indicate the relative density or paucity of the subsurface maze. The latest maps, with their “upwards revisions” of the real expanse of “Terra Habitabilis Cognita”, will be on hand in quantity at space frontier development trade shows on Earth or elsewhere, to acquaint would be developers, investors, and settlers, with the ever expanding opportunities.

### **Lure of the Covered and Hidden**

In the last issue [page 11 “Naming Lavatube Settlements”], we mentioned some of the especially romantic names available from Earth’s literature and mythology that would seem specially appropriate. While choosing such names might have a welcome initial moral-boosting effect on the settlers (after a time, a name becomes just a name), the naming of a new or proposed settlement or of its host lavatube, will be a very conscious and deliberate part of “packaging” aimed at prospective new settlers, developers, and investors - in a mostly friendly but ever serious rivalry for the most and the best. After all, any community is a virtual “team”, and some teams are quite frankly better and more successful economically than others.

Together, rival lavatube settlements can chose language, phrases, conjure up images etc. that will predispose would-be-settlers to choose one of them over a surface settlement. The safety angle of given all-but-invulnerable shielding (“Realm of the [Inner] Firmament [Down Under]”) will be played up. Brochures will invite: “Come to the Moon’s Inner Sanctum”, “Visit the Inner Worlds of Luna”, “Experience the Mystique of the Moon’s “Hidden Valleys.”

To reinforce the general impression, some developers will specialize, not in settlements per se, but in “Utopia for a Moment” resorts: Lunar Hidden Valley recreations of mythological utopias: Camelot, Shangri-La, Walden, Briggadoon, and so on. Tongue-in-cheek, a legend of lavatube formation, not as relic dry subterranean lava wadis or arroyos, but as “lavaworm holes” will catch the attention of the over imaginative fantasy-loving.

And something too for the all important market segment: the risk-it-all for adventure types. Ads will hype the possibility of finding more than just empty wall-fused vacutoria - of finding special treasure troves of inestimable market value. If we find just one lavatube in which a penetrating-but-not-collapsing comet has vaporized to freeze

out as a minable coating of ice on the tube’s walls, a new “49er” or “Klondike” rush will be on. And there may be insupportable and unconscionable talk of lavatubes full of gems, or of easy-to-imagine alien-left troves of high technology craft and equipment, etc.

### **That Extra, Communal Vocation - “Archiving”**

The primary asset offered by the lavatube environment is “protection - protection with a multibillion year warranty”. Any intact lavatube on the Moon has already survived nearly four billion years and will loooong outlast any feature, surface or subsurface on the geologically active Earth.

These are sanctuaries from bombardment - the vast bulk of tube-collapsing impacts occurring in the 500 million year epoch early in Solar System history, when there was still a lot of planet-forming debris to sweep up. Team that up with the “ideal” designer combination of radiation-free, ultraviolet-free, solar flare-free, fixed temperature ultra-dry “lee” (shielded) vacuum. What we have, in great abundance, is a place in which to achieve, store, and preserve humanity’s treasures , not just for the current age, not just for millennia, not just for millions of years, but for billions of years to come, for as long as humanity will be able to inhabit the Inner Solar System.

And Beyond. Long after we have vanished from the stage, what we have preserved in lunar lavatube archives will remain a well-preserved, degradation free reliquary for the examination of any other intelligent folk who come our way. Eons-stable lavatubes are the very first place, indeed the only place, any visitors would think to look for preserved ancient relics of a native but now-extinct or just-vanished spacefaring species. Such visitors might indeed be <our own distant progeny>, making a pilgrimage to legendary Earth Space in search of their roots.

The establishment of some Grand Archives of All Humanity in a lunar lavatube site is potentially the greatest gift (after an environmentally rescued and preserved home planet, of course) we can bequeath successor human generations to come. So what might we store and preserve therein.

- Artifacts and Art Treasures and Libraries: Just consider how much has already been lost forever: the Library at Alexandria, the Mayan Codex, the art treasures of Florence ruined by flooding of the Arno, architectural treasures devastated or destroyed by wartime bombing, by earthquakes, by acid rain, etc. And books whose doomed high-acid content pages might have been stabilized in cold, dry, radiation-free vacuum. And films!
- Collections of Biological Specimens. Sperm and Seed and Pathogen Banks
- Collections of Antique Furniture Treasures
- Collections of motor and other Equipment that will never rust or be attacked by corrosives
- Genealogical Files
- Cryogenic storage of bodies, for burial, for future medical science, for future revival

Only a small number of lavatube settlers may be involved in this special industry tailor-made for tube towns. Yet that the lunan lavatube community as a whole serves this special unique added function of inestimable economic impact long term and a vocation of unfathomable cultural, psycho-

logical, and spiritual impact, is likely to insert itself in the general communal consciousness at large. It will be a point both of pride, and duly prideful self-identity. In archiving, Lunan lavatube dwellers will serve a need no other pocket of humanity, not even (especially not) any of the bulk of humanity still on Earth!

This Service will quickly become a tradition. It may in time even take on trappings that are quite “sacerdotal” (priestly) in nature. Special technologies will be developed precisely to better preserve, index and catalog, access, and display all of these priceless, timeless treasures. There are sure to be college courses and degree programs (in the various Lunan universities at least) in “Lavatube Archival Science.”  
<MMM>

#### More on Lavatubes in this issue

NOTE: See Tom Billings’ Artemis Data Book™ article on lavatube use which follows below on page 13.



### The Human Migration - A Synthesis

By John Camp\*

[A Paper Presented at MSDC '96, Cleveland, Ohio]

#### INTRODUCTION

World Society is in transition. The Cold War is over, existing power blocks are disintegrating, and social values are challenged. There is transition in every nation. We do not have a choice in that there is change, but we do have some choice in the direction of change.

There is a dichotomy of needs within the societies of the world. There is no consensus as to an appropriate direction for these societies. In parallel with the world view *there is a changing view as to our place in the universe*. Some view our place as subservient to the natural world, others view our place as supreme in the natural world. I would choose a place between. We are an integral part of, not external to, nature and the universe.

Our understanding of technology is sufficient to be misunderstood and used inappropriately; Yet we stand at a juncture in Human History that has no known precedent. The present world view is that we are truly a part of a larger scheme, we are made of “star stuff.” We are living during a

window of opportunity that did not exist before and may not be available in the future. *The price of missing this window is not known, but I would suggest that there may be ramifications to our world society*. We are much like a laboratory experiment, for those who are Theologically inclined, maybe it really is an experiment. Do we grow or do we die? The experiment is direct, do we grow and expand into the universe: or do we die and turn this planet into a cesspool?

Time passes!

#### THE CONCEPT

We are at a window of opportunity for a great social experiment and possibly a necessary metamorphosis. The objective of this experiment will be: the purposeful permanent human movement and migration into space. (This process is not indented to significantly reduce the human population but like a bud to create a new living organism.) The question is - do we have the courage to take this great leap of faith? *This is not a question of resources. The technology exists, but is there the Human Will?*

The settlement will be a human enclave, a post-industrial cooperative society, but it will not mimic or necessarily be a clone of the society from which it is drawn. A significant challenge will be the development and integration of new ideas into this new society while unlearning nonproductive and destructive ideas and concepts. The human migration into space will have ramifications that have not been adequately considered, most cannot be imagined! These are called, “The Human Problem.” The most significant ramifications will be those concerned with the permanent settlers.

One of the more interesting is that, “You may not be able to go home again!” This is in reference to the second and succeeding generations. Although there is not yet significant hard evidence, there is some evidence that conception and development of a child in low- or micro-g may entail physiological changes that might not be reversible, may not easily be reversed, or that the individual may choose not to readapt to a high-g environment. *Several physiological responses that have already been recognized due to a low-g or micro-g environment are: T-cell inactivity, muscle atrophy, cardiovascular de-conditioning,, and skeletal demineralization.* [1] This might prevent the second and succeeding generations of settlers from returning to a “high-g” environment such as the Earth. Thus, with a society that is diverging from the mainstream of the parent society, there will be a corresponding divergence of moral, ethical, economic, social, artistic, literary, and political values; and in the acceptance of risk. This concept frightens many. There is loss of control.

*Most popular writings have been concerned with the hardware required for space travel.* The ramifications of permanent settlement and the central issue of long term survival and growth have not been adequately considered. There are many writings that do contain portions of truth. The obvious necessities for survival are; oxygen, shelter, water, and food. The minimum necessities for growth are: goals, room for expansion, security, health, and education. For the first settlement in particular: oxygen, shelter, water, and food may only be transported to the settlement in limited quantities. This is because of logistics, time, and cost - not scarcity.

Where else shall adequate resources be acquired? On the basis of discoveries from Apollo, Viking, and work performed by NASA, Space Studies Institute (SSI), universities, and other independent organizations, they can be derived from the soil of the Moon, Mars, and possibly the asteroids.

Oxygen and water can be recovered by using solar and nuclear power to heat the soils of these bodies, [habitat] structures can be constructed from the soil, and fuel can be manufactured from the recovered hydrogen and oxygen.

Soil when hydrated and oxygenated with the addition of small quantities of organic matter, can be the growth medium for food. In a micro-g environment, hydroponics may be a consideration. [2] Plants and their associated micro-organisms will recycle organic wastes and scrub the atmosphere within the settlement. Forced plant growth can be accomplished by elevated concentrations of carbon dioxide and extended light conditions.

Animals can be fed on organic material specifically grown for their use and organics not used by the settlers. Room being at a premium, the plants and animals will have to be carefully selected. A criterion will be the symbiotic relationship among the environment, plants, animals, and humans. Reference the activities associated with Biosphere II. *The settlement, to survive, must become an interdependent "living" organism.*

Our strawman proposal for the settlement or human community is loosely based on the Israeli Kibbutz [3]. The kibbutz is a unique Israeli creation in that it is a social, political, and economic community dedicated to the separation of its inhabitants from the outside world, elimination of social inequality, and the stress of everyday life. However, this proposal will differ in many aspects. *The community envisioned is based on a more capitalist than socialist concept.* The family would be maintained as a social and economic entity, the social atom. Individuals will be required to be responsible to the community for their actions. The individual must have some privacy. Individual initiative will be very important for the survival and growth of the community.

The physical shell of the community will be community property - damage to this shell may be fatal to the community. The community requires a wide range of skills for survival. There should be a continuum of age to maintain social skills and relationships. Integrating elements of common interest must be maintained so that the intellectual life of the community will not starve.

The following are some dangers that have caused problems within the Kibbutz that must be avoided in this community. These pitfalls are: superficial relationships because of excessively close living arrangements, reduced opportunities for women because of child bearing and child rearing, waste due to the lack of awareness (it is someone else's responsibility), reduction of creativity because of pressure to conform, and the lack of well-defined personal goals.

It should be noted that human settlements have failed before. It is possible to build the "ideal" settlement, but can humans live within it? The settlement is to become "home" in the same sense that your childhood home is home even if you left it 30 years ago.

## MORAL AND ETHICAL RAMIFICATIONS

An issue that must be addressed is, "Who Shall Go?" There are at least two choices: one is that any warm body will do, the other that rational thinking will take precedence and demand some selection criteria. The latter choice is the most reasonable. Thus, what shall be used as the selection criteria? Another question that must be answered is: will the persons who volunteered and were selected to live in the settlement be short term visitors or permanent settlers? The selection criteria will be different depending on the answer. *If those selected are for a short duration, the primary criterion would legitimately be that of which skills do these people bring to the settlement and will these skills be transferable to the permanent settlers?* Because of the short duration of stay by the visitors, most of the significant physiological ramifications of permanent settlement may be avoided.

For those selected for permanent settlement the *selection criterion* becomes both difficult and rigorous. Some suggested criteria follow: a history free of serious genetic disorders, emotional stability, lack of fear of enclosed spaces, highly skilled and talented, and responsiveness to group dynamics.

An additional ramification concerning the selection criteria is how much diversity is tolerable and how much diversity is needed? There is concern that a closely matched group of settlers, while initially compatible and competent, may have serious social problems often over trivial matters and personal idiosyncrasies, not over major issues. The willful introduction into the community of a "random element" should aid in stabilizing personal interactions and would serve as a reference point for normal behavior. Feedback is necessary to maintain a self-correcting society. It will be the character of the settlers, not the care and direction provided by external governments, agencies, or individuals, that will determine the settlement's long term survival and growth.

Who should not go? Those who have not or can not adapt to their existing environment. Malcontents, criminals, and social disrupters need not apply. The settlement is to become a real home to real people.

There are dangers that will be peculiar to a space based or a planetary community that may have its members exposed to low levels of ionizing radiation. Areas of moderate to high levels of radiation should be avoided or worked by those who would not suffer the long term effects of this radiation. These individuals should be volunteers. They might be folk who have a short life span remaining because of age or disease, or they might simply have volunteered. The effect of low level radiation is cumulative genetic damage and some forms of cancer. This suggests that men [should] beget and women bear children very early in life. Radiation proof sperm and ova banks might reduce this problem.

What will be the responsibilities and what will be the cost to the community to care for children and what will be the impact to the community as genetic damage accumulates and appears in some of the children? What procedures will be followed to prevent, reduce, or care for radiation induced cancers? These questions have moral and ethical ramifications; however, at present there are no satisfactory solutions. With a community that will grow and spawn additional settlements,

there will still be a small gene pool. We must not forget that, for growth, risk must be taken, and the consequences accepted. Exceptional faith, dedication, and effort will be needed to overcome these challenges.

## **STANDARDS**

For effective, safe, and efficient living within the community, and efficient interfaces with the rest of humanity, standards will be necessary. Standards such as IEEE (Institute for Electronic and Electrical Engineers), OSHA (Occupational Health and Safety Act), ISO (International Standards Organization), SAE (Society of Automotive Engineers), and ANSI (American National Standards Institute) are appropriate examples. Standards will be needed for such things as space craft and pressure suit interfaces, temperature and pressure, airlock interfaces, AC and DC power, communications protocols, concentrations of oxygen, carbon dioxide, and water vapor, emergency procedures, radiation levels and tolerances, transportation, language, safety, health services, sanitation, quality control, environment, and waste disposal. This is certainly not an exhaustive list.

## **SOCIAL ASPECTS**

There will be requirements for services such as: education, administration, entertainment, child care, medical care, maintenance, and communication - this list can go on! Services will consume, as the society matures, an ever increasing portion of the material, emotional, and personal resources of the settlers and settlement, and in doing so reduce the resources available for production. *These social and economic factors will be driving factors in the "profitability" of the settlement.*

Since the taxpayer/investor will probably pay the initial cost of construction, development, stocking, and transportation, there must be some perceived return on investment. This situation can be alleviated by the wise use of intelligence, initiative, and resources. There is also the "loss" of talented individuals from the parent societies. Though few in number, the losses will be highly visible. As with the "brain drain" from the United Kingdom in the 60s and 70s, there will most likely be considerable political and social debate.

Positive supportive human interaction will be very important for the survival and growth of the settlement. There will be birth, illness, and death. There will be individual and collective grief, and times of mourning for lost family, friends, or coworkers. And there will be joy. These will be the circumstances when the social fabric of the settlement will be maximally stressed.

*The success or failure in these stressful circumstances will determine the success or failure of the settlement.* Work and play must be to a great extent personally rewarding and emotionally satisfying to the individual, since good mental health, or the lack of it, will impact settlement survival and growth. It is necessary to maintain an environment where spontaneity flourishes. The settlement is neither a utopia or a dystopia. It will be a human society with all of its unique human characteristics.

## **EVOLVING POLITICAL RAMIFICATIONS**

*The next logical step in the evolution of the settlement will be the realignment of the settlers' allegiance from their*

*birth nation to that of the settlement.* This will not be appreciated by many. Thus the settlement will be the genesis of the sovereign nation-state. Here is where old issues such as Colonialism and the "Moon treaty" will finally be discarded.

The Moon Treaty has frequently been used to excuse the perceived lack of action by government, industry, and individuals concerning space development. This treaty can be compared to the Pope's division of the Western Hemisphere into Spanish and Portuguese areas of influence [the Treaty of Demarcation or Treaty of Tordesillas, 1494] Similarly with the taxation and mercantilism of the British with its American colony. To those who draft and support such concepts, there is a perceived lack of reality - or these folks have a hidden agenda. The Moon Treaty concept seems to be based on some socialist concept of equality and fairness that is great in principle but short on applicability. That every nation and individual should benefit is philosophically sound. But the proposed concept fails to recognize human behavior, is oblivious to how humans actually operate [and are motivated], and ignores lines of communication and transportation.

## **LEGAL ISSUES**

What type of government will be functional in the settlement? The assumption is made that the settlement will ultimately become a politically independent, sovereign nation-state even though it may have initially been funded by various entities.

There are many forms of government that have not worked. So what are the options? Human nature being what it is, a minimal form of government that will have the ability to convince the individual to conform to a minimum set of standards is a requirement. However, the most effective disciplinary tool is the social atmosphere within the settlement. Excessive force at one extreme with chaos at the other are not acceptable options.

The individual must be part of the governing process. Human dignity must be maintained. The settlement is a social, political, and economic entity. Thus, any governmental decision will have ramifications that will be felt in these three areas - moderation will be important. Decisions can not be made in a vacuum. No pun intended! There will be emergencies when decisions will have to be made with incomplete knowledge and minimal opportunity for contemplation. Thus, those who do serve must be carefully selected, elected, or chosen - their competency is paramount!

However, there is a danger of a too democratic society, where the ignorant has as much to say as the knowledgeable, and that the criticisms of both are [held] equally significant. Law and the application of law can not be capricious or arbitrary. In the environment of the settlement, "things can happen" to those who abuse or take gross advantage of others. The community will not have excess resources to expend on those who could be classified as "antisocial".

Settlements will be established that, among many things, will house those who perform the work of extracting and processing raw materials. In addition, the settlement will support and house those performing research and development. Please note that the location of the settlement or of the material, is not assumed. The raw materials, to be transportable, will



be processed in situ. Thus there is value added before the materials are fabricated into structures, fuel, water, or possibly transported to other settlements, to Earth or near Earth.

The settlers, inhabitants, or workers, call them what you will, cannot be treated as indentured servants. There is adequate evidence that this concept is unhealthy, unwise, immoral, and in the long term unprofitable.

Patents, copyrights and intellectual property issues will need to be addressed. (Given the confusion associated with the Internet on Earth, this issue will be very interesting, if not nearly intractable!)

The settlement will eventually become independent. This process may take 10 years, or it may take 100; but it will happen. Thus, the settlement will be the genesis of the sovereign nation-state. Incorporated within the concept of the nation-state is sovereignty, that is, the ability to control from within and prevent external control of its destiny. This implies that the citizens of the new sovereign nation-state will take measures to defend themselves from aggression. This is generally a fundamental pillar of the legal establishment of the sovereign nation-state. To expect anything else in light of seven thousand years of documented human history would be foolish.

Human history is replete with claims made in the "Name of the People". Some of the more recent are "The Peoples Republic of China", or the "German Democratic Republic". The "Moon Treaty" is in the same vein. A more reasonable process would be the gain to the "Peoples of Earth" by the growth and expansion of industry with the associated employment and tax base. The most valuable product may be a new point of view with respect to our expansion into the universe. Recognize that the results will not and cannot be equally distributed. What is required is real people producing real goods and services for real people. This is a capitalistic concept that disturbs many. *If the desire is for "equality" and "fairness" in benefit we are looking for the impossible, and it will be found in broken dreams, anger, unfulfilled expectations, and revolt.*

Given these realities, it is time to recognize the real world. Extra-Earth resources will, sooner or later, be used for the benefit of those who access them. There does not seem to be a way in the long term to force any other conclusion. A consideration that is usually unrecognized is that the moon, planet, asteroid, or location in space is of intrinsic value itself because of location, not necessarily the material resources that can be extracted and exploited. Independent settlements will use these resources for their [own] expansion and benefit.

### **ECONOMIC RAMIFICATIONS**

*The settlement will be an economic entity.* The settlement will have a portion of its folk involved with food production, manufacturing, and information processing. These activities will be necessary for the growth of the settlement. The settlers will be "paid" somehow. There may not be money as we presently know it, but there may be an electronic bank where funds, or their equivalents can be deposited.

Taxation and intellectual property issues will become major drivers in the move to independence. *The settlement's political representatives will probably be at least 250,000*

*miles (400,000 kilometers) away.* The building of schools and roads on Earth do not relate to the needs of the settlers especially if they will not be returning to Earth.

What form of "taxation" will be implemented in a politically independent nation-state is another issue. There will be few goods and services on which to spend money. There will still be a great cost to move material objects out of one gravity well into another. Earthly trappings of wealth and power are frequently displayed by the possession of things. The same might be displayed in the settlement, such as a painting or a genuine French Provincial chair.

This new society, like the Kibbutz, by its economic nature, provides food and shelter to its members; this is a common cost coming from the community effort. As the community or the sovereign nation-state grows, this will most likely change. The settlers will view the universe in a very different perspective. Issues of money and possessions could be manifested in a manner totally unexpected.

Some suggested economic opportunities [for the settlement] are: antimatter production, production of spacecraft hulls by organic growth [4], and optical and radio astronomy.

### **LONG TERM RAMIFICATIONS**

An acknowledgment must be made that we as humans probably will not soon lose our humanity, though there may be some near term physiological and psychological changes by our migration into the universe at large. I could be wrong! This is an area that will benefit from much discussion.

Humans will eventually explore and settle where the environment is manageable. The available resources will be exploited for their use. In accomplishing this task of human growth, I submit that our humanity will be reinforced. We will discover that problems will not miraculously go away; we will not escape those things that are problems today. We will buy time in some areas. However, the human problems we recognize today will still be with us in some form tomorrow. The human challenge then is to grow, mature, thrive, and overcome adversity.

### **THE GOAL**

What will be the greatest product of this social experiment? I submit that the spawning of self-reproducing, healthy, dynamic, evolving sovereign nation-states, and ultimately [whole new] worlds, will be this product. Ultimately, in doing this, we will come to a better understanding of ourselves and ensure our survival as a species.

### **CONCLUSION**

Human settlements will be established off Earth. The exact locations and purposes can not be known. Trade will consist of: raw and processed materials, intellectual property and information, and things that cannot be imagined at this time. The settlements will develop their own unique cultures, some of which may not resemble any society now recognized on Earth. These settlements will become independent in the sense that the existing sovereign nation-states are independent. The settlements, ultimately worlds, will form an extended human family with all of the nuances associated with the human family today.

JC

### FOOTNOTES to the Preceding Essay:

- [1] "Gravity, Calcium, and Bone: Update, 1989" Technical Support Package, NASA Tech Briefs ARC-12717, NASA, 1989, Moffett Field, CA.
- [2] "Phenolic Foam for Hydroponics" Technical Support Package, NASA Tech Brief NPO-18319/7840, NASA 1992, Jet Propulsion Laboratory, Pasadena CA.
- [3] "Kibbutz Makom" A Report from an Israeli Kibbutz, by Amiá Lieblich, Pantheon Books, 1978, New York, NY.
- [4] "The Thirds Form of Life" by Michael W. Gray, Nature, Vol. 383, pp. 299/300, 26 September 1996.

\***John Camp:** Mr. Camp is an electrical engineer employed at Wright laboratory's Avionics Directorate, Wright-Patterson AFB in the Simulation Technology Branch. He is heavily involved in amateur radio and has participated in organization and planning of the Dayton Hamvention, the largest amateur radio convention in the world. John was a founding member of Dayton, Ohio's first NSS chapter. He lives in Enon, Ohio, with his wife Linda.

#### Relevant Readings from Back Issues of MMM

- MMM # 34 APR '90 pp. 5-6 "The Fourth 'R'", pp. 6-8 "Restructuring the Economic System in Support of Environmental Stewardship"
- MMM # 35 MAY '90 p. 3 "Ports of Pardon"  
[republished in MMMC #4]
- MMM # 47 JUL '91, p. 5 "Native Born"; p. 8 "Empire"  
[republished in MMMC #5]
- MMM # 52 FEB '92, pp. 3-5 "Xititech"  
[republished in MMMC #6]
- MMM # 92 FEB '96, p. 7 "Who Will Pioneer?"  
[republished in MMMC #10]

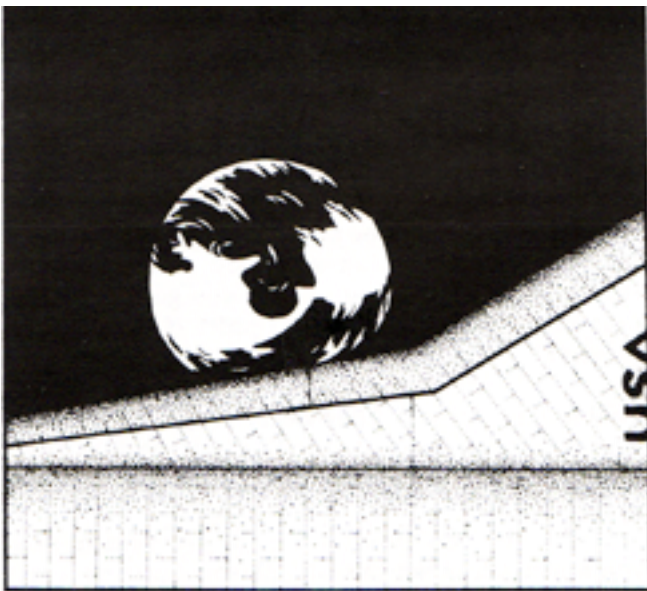

© Shannon S. Yaeger, 1996

### The Artemis Project: "Landing Day"

A fictionalized anticipation by Gregory Bennett\*

The viewing room in the Mission Support Center is a huge circular auditorium. Up to now there has been plenty of

room, but tonight it is filled to overflowing. Folks in the back of the room are so excited that they do not even realize they are jumping from one foot to the other. They have been standing for the past two hours, ever since the crew moved into the landing stack to take her down.

The spacecraft is just around the limb of the Moon over the far side. Abruptly, mission control picks up a relay through the Lunar Transfer Vehicle as it orbits just ahead of the landing stack.

"Hey Earth! We're back with ya through the LTV," the mission commander says. His voice is startlingly clear through the radio link. "Coming down right in the groove. You should be getting some video of Lobachevsky Crater right about . . . now!"

The main viewing screen springs to life. A huge crater dominates the lunar landscape. In the black sky above the crater are the words: LIVE FROM THE MOON. Other monitors flash scenes from around the world. You realize that billions of people from all corners of the Earth are sharing the experience with you. They crowd into mission support centers like the one you are in, and into theaters, malls, parks, auditoriums, and classrooms. You can spare just enough of your attention to marvel at so many human minds directed toward this one goal: the return of human beings to the Moon for the first time in nearly forty years.

And this time, we're going back to stay.

"Here we go," the commander says. "Hertz Crater. That's the one in the middle of the chain. We'll get back out here to explore that area next year."

A skinny red-haired girl quietly slips onto the step beside your seat. You don't even notice her until she nudges your elbow and whispers, "How long?" — She couldn't be more than twelve, just about ready to start thinking seriously about puberty. From the stains and worn spots, you get the feeling that her Moonbase Artemis T-shirt is her favorite garment.

"About ten minutes. Watch the TGO display. That's 'time to go'." Your own whisper sounds too loud in the hushed room. Nobody is talking. Their eyes never wander from the big monitors hanging overhead.

When you look toward the girl next to you, you notice she is not the only person sneaking a seat in the aisles of the auditorium. You shoot a nervous glance toward the fire marshal, worried that he'll be shooing people to the back of the room to keep the aisles clear, but even he is unable to spare any thoughts for the crowd.

On the monitors, the vast, dark plains of Mare Marginis unfold before you.

"Wave at Mr. Goddard as we fly past, folks!" The commander is referring to Robert Goddard, the father of American rocketry. Images of Goddard and his early gasoline-powered rockets flash onto the information screens. A large crater on the northern rim of Mare Marginis honors his memory.

You are one of the Veterans, one of the few who have been with the project since the beginning. Perhaps later you will feel guilty about having a front row seat while all those people have to stand, but for now, there is only the Moon.

Your hard work and diligence earned you this seat.

The dark basaltic plains of Mare Marginis slip out of view, to be replaced by rolling hills.

"There's Cannon Crater, right on time," the commander says. "We're going to roll for the final approach. Hey, there's a great view from the inside cameras now. Take a look through the porthole!"

It looks like a short boot; dark soil surrounded by the silver gray of the surrounding hills. Mare Anguis, and Angus Bay [see page 12]. The goal. Home. Beyond, the ragged rim of Mare Crisium. The dark terminator cuts across the shining, sable carpet of the Sea of Crises, hiding her secrets for days to come. It is just past sunrise at Angus Bay. In the sky above, Mother Earth. You are seeing yourself, from a viewpoint a quarter million miles away.

The commander stop his chatty narrative. He is feeding information to the pilot. "Looks like we're headed right for the central peak of that crater there. Veer just a bit to the right. Yeah, head for the rim. OK, bring her down. Fifty feet. Hey, there's some dust, just like Buzz said there'd be!

"OK, Earth, we picked our spot and we're hovering at twenty feet to yaw into position."

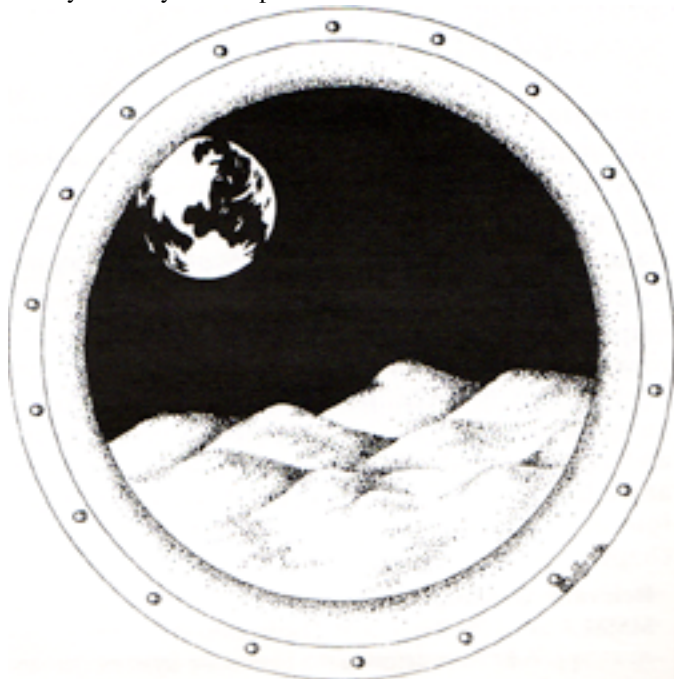

© Shannon S. Yaeger, 1996

As the spacecraft turns, the porthole camera sweeps the landscape. It comes to rest showing a path of dark, smooth terrain leading out into the vast reaches of Mare Crisium. Soon people will be following that path, seeking out the treasures lurking in the soil of the dusty plain.

"Spot on," the commander says. "Earth is perfectly centered in the frame. Let her down. Ten feet . . . five . . . contact light!

"Earth, Angus Bay here! Artemis has landed."

You strain to hear what clever bon mot he will have to say about the return to the Moon, but his voice is drowned out by a fusillade of champagne corks. No worry, you will hear it again and again on the news and in the documentaries.

A fellow comes by with a rack of glasses and bottles

to fill them -- champagne and soda pop, both festooned with the labels of Proud Sponsors of the Artemis Project. When you reach for a glass, you realize your hand is still captive in both of the red-haired girl's hands. The realization hits her at the same time and she snatches her hands away. You smile, and lift your glass to her in a toast: a toast to new beginnings.

It has begun. This time, for keeps. **GRB** 

\* Greg Bennett, chief architect of the Artemis Project and CEO of The Lunar Resources Company, is a space-craft engineer and a published science fiction writer .

---

## How Angus Bay got that Name

Renaming the proposed Artemis Moonbase Site  
[See "Landing Day" on pp. 11-12 by Gregory Bennett]

In October 1995, during the *First Contact* science fact & fiction convention in Milwaukee, Peter Kokh and I found ourselves in happy agreement about the criteria for selecting a site for the first lunar community. Working independently these past many years, we'd both come to the conclusion that the best place for an exploration base would be somewhere on the shores of Mare Crisium. The main criterion I had that Peter didn't list was the cinematographic desirability of having Earth in the frame for photography. That had lead me to the western shores of Mare Crisium (instead of the eastern, on which Peter had been concentrating).

In the northeast corner of Mare Crisium you'll find an inlet named Mare Anguis. ("Anguis" on some maps. It's not listed at all on many Moon maps, although the feature is larger than many of the prominent naked-eye craters.) Peter was delighted with this choice for all the reasons we've discussed before in this topic. Then he went off to take a look at his Moon globe.

Peter returned with a look of horror that he ought to trademark, and said, "*SEA OF SNAKES?*"

"Let's call it Angus Bay," I said.

The feature isn't really large enough to call it a sea anyway, more of a bay [Latin *sinus*; or lake, Latin *lacus*] off the Sea of Crises, a nice protected harbor {Latin *portus*} with access to the main body. Renaming it Angus, instead of Anguis, is merely an exercise of our prerogative as lunar explorers. Four and a half centuries ago a few Latin-speaking astronomers coined terms which fit their purposes, but there's no reason why those who put their footsteps where others could only observe should be bound to slavishly follow those traditional names.

I'm sure other lunar features will soon have new names more suited to the people who live there. The days of Mare Fecunditatis are numbered.

Greg Bennett 10/24/95 

---

## Lunar Lavatube Use

by Tom Billings <itsd1@teleport.com>

© 1996 Artemis Society International

<http://www.asi.org/adb/02/01/lavatube-use.html>

The Lunar Base Research Team of the Oregon L-5

Society looked into the possibility of coating lavatube caves in some work they did for Lockheed in 1988-89. Remember that lunar lavatubes probably can be far larger than the (approximately) 25 meter diameter limit here on Earth. In addition, any nonmetallic native coating material can be expected to crack as it cools.

Measurements of collapse trenches believed to be associated with lunar lavatubes indicate diameters of several hundreds of meters. Given this situation, the Team evolved several ways to use lunar lavatubes.

First, it would make sense just to use them as shelter from radiation, temperature changes, dust, etc. for rigid or inflatable habitats brought from Earth. This alone could mean large cost reductions by reducing the "emplacement costs" otherwise necessary for such shelter requirements.

Second, it was noted that lunar glass fibers might be combined with native meteoritic iron-nickel particles to produce larger habitats from resources on the Moon. During the 1980s, Dr. Brandt Goldsworthy showed the possibility of making very strong glass fibers on the Moon. Native meteoritic metal could be refined by the "carbonyl" method, and the metal carbonyls used to produce a thin, tough, airtight metal layer on the inside of a habitat woven from lunar glass fibers. These habitats, inside lavatubes, would increase the available sheltered cubic volume greatly, and do it with cheap native materials.

Finally, if it is required to have an entire town inside one of these very large tubes, with the entire tube sealed, then the meteoritic nickel-iron could be used again. First use the carbonyl process to produce the pure metals in powdered form (micron-sized particles), as is done at Sudbury, Canada in producing much of the Earth's nickel supply. Then, chill the powder with Lunar LOX. Now, put it through a modified (bucketless) mass driver some tens of meters long and shoot it at the walls of the lavatube at a 90-degree impact. With a velocity of about 2-3 kilometers/sec., the powder particles will splatter/self-forge to the wall of the tube, building up a layer of metal that seals all but the smallest cracks. To make sure that no leaks remain, we may now introduce gaseous carbonyls into the tube, and use Laser Chemical Vapor Deposition with a solar powered laser's beam to get a final continuous film producing an airtight seal.

The advantage to these methods is in limiting the amount of molten material that is handled in any bulk, especially in the open, especially around any humans. Either molten metal or molten rock/glass/lava are very corrosive. They require large amounts of energy to produce. In the case of molten aluminum, this means large amounts of electrical energy, which is already a major bottleneck in space operations. Carbonyls are non-corrosive liquids at room temperatures and are reduced to metal and CO at about 200°C at low pressures. The iron and nickel carbonyls require only carbon monoxide gas passed over the native material at 160°C to generate the carbonyl. In the vacuum of space they should be much safer and cheaper to handle. This should allow significant cost reductions to lunar base activities fairly soon after the first outpost is in place, or with sufficient telerobotic preparation, at the first outpost itself.



## Study on Inflatable Lunar Habitats

by William H. Mook <wm0@s1.ganet.net>

© 1996 Artemis Society International

[www.asi.org/adb/02/06/inflatables-study-1.html](http://www.asi.org/adb/02/06/inflatables-study-1.html)

William Mook has prepared a number of studies on space development, some of which relate directly to the Artemis Project's goals. This concept of an inflatable habitat could be a possibility for expanding the pressurized space of Moonbase Artemis™ for increased crew, or for lunar tourism. He has posted a brief summary of his study:

Polyester film has a yield strength of about 25,000 psi. So a reinforced polyester film blown to form a 60 foot diameter sphere would need to be about 1/80 inch thick to sustain a 3.75 psi pressure. You would need about 1/20 inch thick film to sustain 14.70 psi pressure. Assume an outer shell 1/80 inch thick, and an inner shell 1/80 inch thick, separated by 2 inches. The film is bonded together every 2 inches or so by kevlar netting. The space between the two films is filled with lightweight polystyrene. The whole sphere would inflate from a small pillbox type container. Assuming 3.75 psi working pressure, the sphere would weigh about 1,275 lb. The oxygen would weigh 2,225 lbs! More than the container!

Five floors would be formed the same way, deployed along with the inflation of the spherical shell. They would consist of 2 sheets of polyester film separated by a kevlar reinforced polystyrene filler. The poles of the sphere would be connected by a lanyard-deployed continuous long-eron coilable boom. This would interconnect the five floors.

Starting at the south pole of the 60 ft diameter sphere, the first floor is 5 ft above the pole. It is a circle 46 ft in diameter containing 1668 square ft of space. The second floor is 15 ft above the south pole. It is a circle 53.6 ft in diameter and 2262 sq. ft. in area. The third floor is largest, with an area of 2,750 sq. ft. and a diameter of 59.2 ft. We then repeat the same sequence in reverse. The sixth panel is actually the ceiling of the fifth floor. The mass of these floors is 1,200 lbs. The mass of the vertical shaft is 280 lb.

Assume the sphere is inflated on the lunar surface, from the nose of a landing craft. The craft is a cylinder 12 ft in diameter and 18 ft tall. From the side of this cylinder is a 30 ft long, 10 ft diameter tube cut into two sections. The end of each section has attached to it an airlock door made of diffusion bonded/superplastically deformed titanium. The weight of each airlock is 480 lb. The weight of the outer tube, made of polystyrene foam inflated polyester film is 360 lb.

Another lanyard-deployed continuous long-eron coilable boom connects each of the airlock doors. The innermost door is attached to the airframe of the pillbox/spacecraft. This spacecraft contains all the environmental control systems as well as consumables. It is airtight, and forms a link between the airlocks and the station above. It also is a control center from which to control the station. The longeron coilable boom weighs 150 lb. So, the total station weighs:

- 1,275 lb. Shell
- 2,225 lb. Air
- 1,200 lb. Flooring
- 280 lb. Vertical Boom
- 150 lb. Horizontal Boom (walkways)
- 480 lb. Titanium Airlock Door

480 lb. Titanium Airlock Door  
 480 lb. Titanium Airlock Door (attached to S/  
 360 lb. Horizontal Airlock Tube  
 6,930 lb. SUB-TOTAL  
 4,620 lb. Deploying Spacecraft & ECS Equipment  
 11,550 lb. TOTAL

Once the balloon was inflated 24 tethers bonded to the outer surface around the equator of the sphere would drop down. These would be anchored into the lunar surface. Netting would be attached between these tethers. Lunar soil would then be piled up around the netting, forming a radiation-proof area in vacuum under the sphere. As the soil is piled up it eventually covers the sphere, creating a unpressurized radiation proof area within. Access is by the 30-ft tunnel connecting the outer terrain with the central column. There is a total of 10,610 usable square feet within the sphere.

Illumination is via fiber optics. An inflatable parabolic mirror 1516 sq ft. in area (44 ft diam.) concentrates sunlight into an optical fiber. This fiber makes its way into centerline of the sphere and up the central column. There light is projected through diffusers to illuminate the interior of the habitat. The mirror is part of the equipment mass budget (it weighs less than 50 lb.) and is inflated upon arrival. The system provides illumination during the 2-week long lunar day, and a high intensity bulb provides illumination at night via the same optical fiber setup.

Power can be supplied by a small PV array operating at 1000 solar intensity - at the focus of another 44 ft diameter mirror. This provides energy during the lunar day. Propellants are used in fuel cells to power the station during the lunar night. Early inhabitants will occupy the station only 2 weeks every month. Up to 30 people may use the station at one time. Only a 3-person skeleton crew maintains watch at night. All others depart to minimize energy usage.

**Critique by Greg Bennett**

I think William Mook made an error in calculating the diameter of the first floor of the habitat. It ought to be 33.2 instead of 46 feet. (Looks like he used the diameter instead of the radius of the 60-foot sphere.) But nevertheless his description of this habitat shows quite well how much habitable volume we can get from a simple inflatable.

The thickness he chose for the habitat pressure shell, and the reasons for it, are a bit worrisome. If we're to have a bioregenerative life support system based on terrestrial plant life, we'll want an atmosphere pretty close to Earth normal; and using a pure oxygen atmosphere, even at low pressure, for extended habitation is more of a cavalier risk than I'd be willing to take.

The mass of the pressure shell will mostly likely be sized for impact loads more than retaining pressure. With nothing but that shell between you and oblivion, you wouldn't want it to be so flimsy that you'll puncture it if you drop a screwdriver. The real value of an inflatable pressure shell comes from its packaging efficiency rather than its mass compared to, say, an aluminum tank. This translate into launch mass because the parasitic weight of packaging material will be less for a given volume.

**Constructive Comments from the Editor**

- Other writers have suggested using an Inflatables as a form

against the inner side of which to deposit a durable and relatively thick (e.g. 0.25 in.) coating of metal by the vapor deposition method - to provide security against decompression accidents.

- While spheres and cylinders may come most easily to mind when considering inflatable structures, a torus, even if more difficult to fabricate, has the advantages of enclosing a similar volume in a much lower structure with a wide stable footprint. The lower structure makes shielding emplacement that much easier, while the wide stable footprint makes the guy wires unnecessary. The donut hole of the torus can be filled with a compact rigid "works core" structure. If the torus is fabricated so as to inflate out of peripheral side lockers of such a core, making the whole a hybrid, then outfitting the still empty inflated torus with structural elements that pop out or unfold out of the works core will offer a clear advantage. The whole hybrid "moonbagnet" can be delivered to the Moon in one package, unfolded and ready to shield, ready to use. 🌑

**Relevant Reading from Back Issues of MMM**

MMM # 50 NOV '91, p. 7 "Lowering the Threshold to Lunar Occupancy: HOSTELS: An Alternate Concept for both First beachheads and Secondary Outposts, IV. Hostel-Appropriate Architectures, d) The Hybrid Torus or "Donut" (illustrated)

Republished in MMMC #5

**Triple SpaceHab™  
 Artemis Moonbase™  
 Lunar Habitat Module**  
 by Gregory R. Bennett, 1996

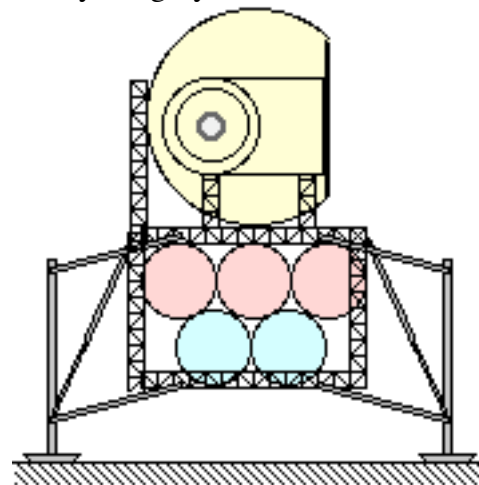

**Editor's NOTE:** The Original Artemis Project™ Reference Mission called for using a Space Station habitat module for the initial lunar base installation. It was to be landed vertically, then winched horizontal. The current plan is to use much less expensive, already off the paper, and purchasable SpaceHab modules coupled in double or triple configuration. Each of these by itself offers much more usable volume than did the Apollo era Lunar Excursion Modules *Eagle*, *Intrepid*, *Antares*, *Falcon*, *Orion*, and *Challenger*. Unlike these, the SpaceHab complex would *stay* on the Moon, and not be used as return capsules

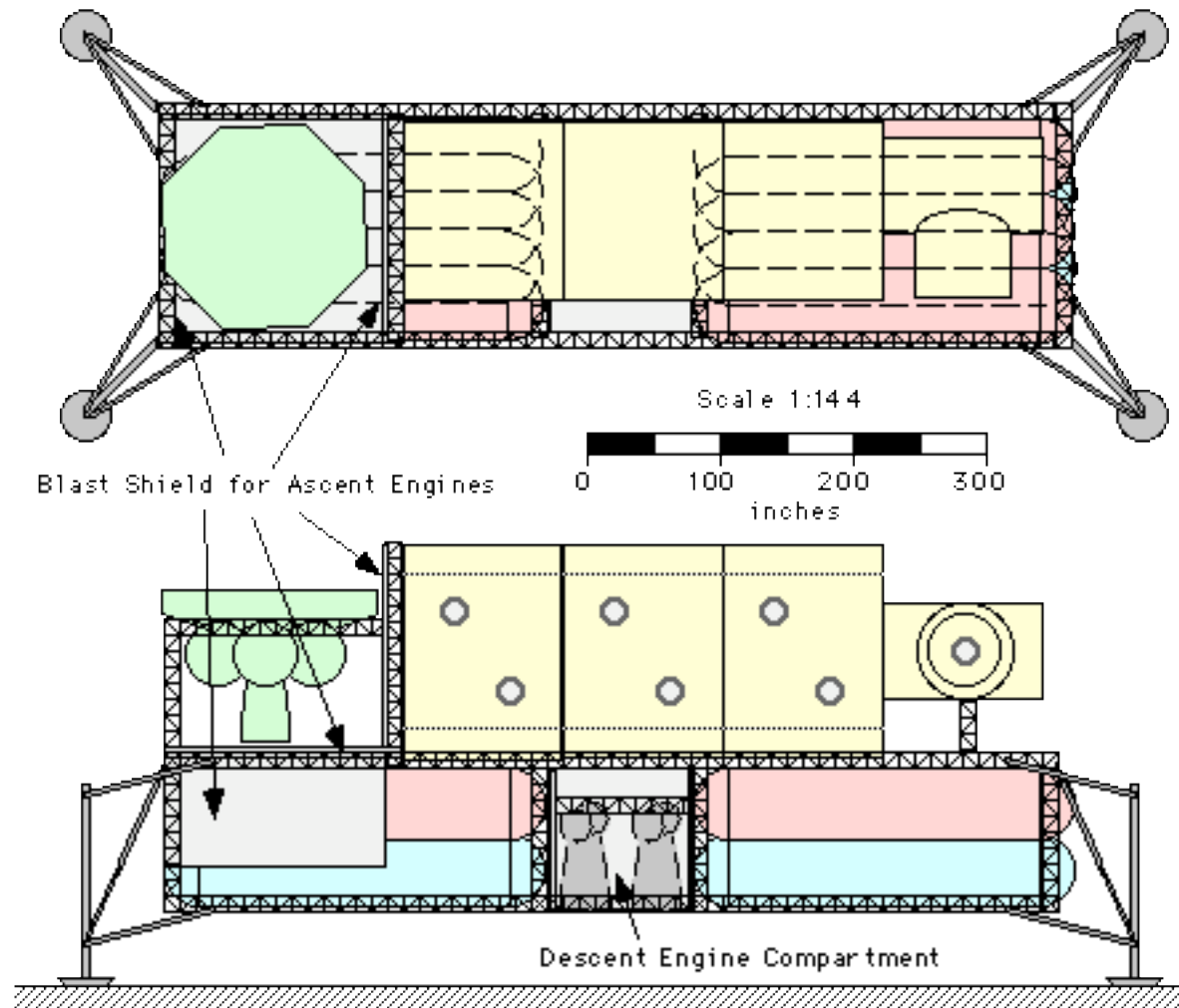

**MMM #102 - FEB 1997**

### Making "TIME" Work For Lunar Settlers

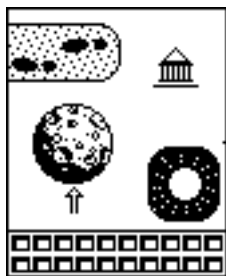

We're in the "SPACE" business, if only by hobby and advocacy, or so we think. But to the extent our efforts and advocacies will bear fruit, we need to realize that we are just as heavily into the "TIME" business.



That's the theme of this issue from the editorial essay to the articles inside:

- "Footprints and Other Leavings"
- "Lunar Polar Ice" with a plea by Jim Chestek
- "Luna City Museum, 2097 Visitors' Guide"
- "Archive Luna"

### Technical Comments on the MMM # 101 Lavatube Articles

By Bryce Walden, *Oregon Moonbase*

Congratulations to *Moon Miners' Manifesto* on its 101st issue! We have enjoyed every issue, chock full of interesting and provocative ideas on the development of the space frontier.

The Oregon Moonbase team especially appreciates the extensive coverage given to the topic of lavatube caves in Issue #100. Peter Kokh did a lot of work developing the arguments and provided some very nice illustrations of various concepts.

In the interest of completeness, I would like to add a few technical comments as they occur in my reading of the articles.

#### *Lavatube Stability vs. Human Activity*

In "Twelve Questions About Lunar Lavatubes" Kokh correctly states that caverns that have survived for over 3 billion years are probably very stable. Yet I feel obliged to add the caveat that human activities could at times threaten that safety. A lavatube that has survived may still have suffered trauma that makes certain parts of it weaker, such as a meteorite strike over part of the roof. Sections that survived the

relatively minor moonquakes over the millenia may fail if we blast during construction. Also, lava that is strengthened by incorporating super-strong anhydrous glass may weaken over time if exposed to water vapor from atmosphere or other gas-releasing activities. Sealing and pressurizing a lavatube will also introduce new stresses, as he himself mentions in a subsequent article. To mitigate these effects, there are engineering precautions that can be taken on a case-by-case basis.

### **Lavatube Temperatures**

The "steady temperature" of -4 °F is based on Apollo temperature measurements that reached equilibrium within several centimeters from the surface and stayed fairly constant from there to as far down as the astronauts could measure, roughly 2-3 meters. Deep mines on Earth get quite hot from heat bleeding away from the mantle; this could happen on the Moon, too, but probably to a much reduced extent due to the relative coldness of the small lunar core. As a rule lavatubes don't have much vertical development but run parallel to the surface. There may be older lavatubes in deeper layers of lava, as his article points out. Once again, the real problem is likely to be human activity. Lavatubes are good insulators. On Earth, cold air can fall into a lavatube in winter and remain below freezing through summer heat. Our case will be just the opposite. Human activity generates a great deal of heat, and the lavatube is a relatively closed environment. For awhile this could be an advantage, and raise lavatube temperatures to comfortable levels, but we are likely sooner rather than later to have to engineer some heat-sink solutions. Changing temperature can also be a source of stress to the cave vault.

### **Gross Available Lunar Lavatube Volumes**

In terms of ready volume available now, we did a poster session at the 22nd Lunar and Planetary Sciences Conference that partially addressed this question. Cassandra Coombs, for her doctoral dissertation under Dr. B. Ray Hawke, identified a number of probable lavatube sites from high-resolution Apollo photographs and Lunar Orbiter pictures. Only the largest possible candidates were resolved by these sources. Cheryl Lynn York and I selected the largest 20 of these sites. Making a working assumption of circular caves of width and length identified by Coombs, then half-filled with congealed lava or breakdown, we computed over 3 billion cubic meters of volume, nearly 14 million square meters of "floor" area, or about 0.0531 of Peter's "O'Neill Units" of 100 square miles. The average of these twenty large lavatubes was 470m diameter, length 1,370m, roof thickness 66m, floor area 687,685 m<sup>2</sup>, and volume 157,908,640m<sup>3</sup>. Incidentally, these "Top 20" lavatube caves were located in only four rille formations, with rille "collapse trenches" separating the various caves.

### **Lavatube Volumes vs. O'Neill Habitats**

I checked Kokh's 100 square mile "O'Neill Unit" with O'Neill's figures in **The High Frontier**. He claims an *Island Three* habitat, 20 miles long and 4 miles in diameter, would have 500 square miles of land area. Each of the three "valleys" in the interior would be 20 miles long by 2 miles wide, or 40 square miles. Three of these totals 120 square miles. Total cylinder interior surface area (including windows) is 251

square miles, while endcaps area equals a sphere of radius 2 miles, or 50 square miles. The remaining 199 square miles must be made up by numerous small "agricultural modules" outside of the main habitat, in O'Neill's total design. But for convenience in figuring, 100 square miles is very roughly correct for the popular conception of the "valley" areas in an *Island Three* habitat.

### **Lavatube Remote Mapping**

On "Remote Mapping of Lunar Lavatubes," Tom Billings' paper "Radar Remote Sensing of Lunar Lavatubes from Earth" was published in **the Journal of the British Interplanetary Society**, Vol. 44 pp. 255-256, 1991. A more inclusive treatment of "Lavatube Remote Sensing" was given to a seminar sponsored by the Lunar and Planetary Institute in 1992. In regard to side-looking infrared, the detection of a lavatube temperature signature would, we think, be easier during lunar night, when the exposed surface temperature reaches -240 °F. The comparatively "warm" -4 °F lavatube interior would then be virtually the only "warm spots" on the volcanically inactive Moon. During lunar day, it would probably be harder to differentiate cave interior temperatures from normally shadowed areas on the surface. Such an investigation would have the serendipitous (or even primary) effect of finding any volcanic "hot spots" that may be expressed at the surface (there are indications of a few areas of recent lunar volcanism). Such areas would be mineralogically (= resources) interesting.

Kokh's articles about lunar lavatube habitats and environmental manipulation were right on the money. Beside our own work on these topics, including a study performed for Lockheed, another researcher who has given some thought to lunar lavatube habitats is Andrew Daga, <Daga1@aol.com>.

In all some very inclusive articles, "in depth" coverage of lavatubes, as it were, most welcome and well done. Thank you, Peter!

*Bryce Walden*, <BWalden@aol.com>

Oregon Moonbase

P.O. Box 86

Oregon City, OR 97045-0007



Relics of the "Scouting Period" will all be preserved as a part of on site Lunar Frontier National Parks and Monuments or placed in Future Lunar Frontier Settlement Museums.

by Peter Kokh

One frequently hears complaints that we have already "trashed the Moon" referring to equipment and equipment packaging and other items left behind on the Moon by the Apollo explorers. The speaker silently assumes we will never return to establish a permanent presence on the Moon, that there can be no useful function of such leavings, that they serve only as pocks of litter. Since this set of assumptions is without

justification, it does more to discredit those who parrot the chant than anyone else.

“One man’s trash is another man’s treasure” is an even more common tidbit of popular wisdom, however, and happily one that is definitely more applicable to the situation. “When”, not “if”, we someday return to the Moon “to stay” and make it “Earth’s Eight Continent” and the first of many human adopted home worlds, such items, from derelict space craft stages to scientific instruments to packaging waste to footprints - these will all suddenly become invaluable. They will be priceless “hope chest” contributions to future lunar frontier museums and monuments to the watershed epoch of early human and robotic exploration of the Moon..

Even if, to our great shame and discredit as a sapient race, we fail to use our talents and resources to expand into the human hinterland of Greater Earth as we have into all the other companion continents of our native Africa, the contention that these relics of exploration constitute “trash” exposes an indefens-ible view of man as something apart from, not part of nature. Rather we should have humble pride in these leavings. They are indeed venerable and admirable relics of great achievement and of the enormous capacities with which man has been endowed.

What we have left behind on the Moon is indeed “a promise”, a promise to return, to return and stay, a humble engagement token, a sign of betrothal. Even should this future hoped for mutually adoptive relationship with the Moon not develop, these things will still stand long after the rest of human civilization on Earth has crumbled into dust, as mute testimony to the glorious design of Homo Sapiens and the Creative Agency(ies) that led to our emergence. — whether some scouting explorers of other separately arisen intelligent populations ever stumble upon them and feel the wonder - or not.

There has long been deep discussion of future political and economic regimes for the Moon, and on the question of property rights. However these thorny questions resolve themselves, and we have strong opinions on how they should) some very important, and arguably less controversial, legal questions are going unaddressed. Addressing them now could create a momentum of achievement that might help break the paralyzing logjam of endless debate over the other more disputed issues.

For example, we might now set up definitions, standards, and procedures for declaration of various sites and areas of the lunar surface as the lunar equivalent of national parks, national monuments, national scientific preserves etc. Procedures for nominating a site, for establishment of the special status, and for amending that status in the future are needed. At this date when evidence for a case of objection can not be maturely prepared (e.g. unique geochemical resources of critical economic value) candidate sites could remain simply “nominees”. Protocols for the establishment of economic concessions that do not infringe on the scenic or geological rationales for the nomination, could be decided upon now, subject to revision as the on site learning experience unfolds. Might it not be unreasonable to expect that solving these “special” cases will help point the way to acceptable “general”

solutions of the property question?

In addition to such special treatment of nominated areas of special scenic and/or geological interest, the historic sites of early lunar robotic and human exploration should be included. In each case, the immediate site could be handled as an easement, with use and encroachment restrictions passed on to whatever future jurisdiction or public, private, or commercial title as may come to be established.

These sites are just what we have labeled them, “hope chest” items for the future edification and education of lunar pioneers, settlers, and visitors to come. They need to be treated, individually and as a class, with honor, respect, and awe. Popular, if not universal contempt, should be approached as an opportunity for education and public outreach. When and where attitudes cannot be changed, we must sadly learn to dismiss them: “consider the source.”

These remarks are meant to address similar human/robotic “tracks and droppings” on Mars and elsewhere. These things will become the foundation of lore and legend. They will live on, their thoughtless denigrators passing from the scene into oblivion.

As human sites, the Apollo sites need special protection and handling. But even robotic sites are instances of virtual human presence and need attention too. It is not too early to discuss proposals for proper preservation and protection. Some of these sites will become enucleating centers of future human settlement. Others will affect the routing of future highways. Their places on the map are more than footnotes to be sure.

FRMM

## Save the Lunar Ice!

by Jim Chestek

Co-author of *Doomsday Asteroids*

Now that we know that there is a modest amount of ice on the Moon, there is sure to be a vigorous debate on how to use it. There will be a few, no doubt, that will want to keep it in pristine condition; sort of a “wilderness refuge,” to be stared at, presumably, by twenty-second century tourists. But given its immediate value to the twenty-first century, there is little chance that will happen.

Nevertheless, the announced “find” is a sharply limited one. One published estimate is that it is about 81,000 tons of ice. This translates into only 9,000 tons of hydrogen, which is the critical element. (There is an abundant supply of oxygen bound in the Moon’s minerals; not in short supply.)

There are two immediate and strongly competing uses for this very limited resource. The first is life support/ agriculture to support colonists living on Luna. They will use it sparingly, and recycle it endlessly. Even this modest amount will be capable of providing the life support for a small colony.

The second, and more immediate use is for rocket propellants. We are accustomed to using hydrogen/oxygen rocket propellants, and they are almost the best chemical propellants possible. Used in this manner, the water (hydrogen) on the Moon will be used only once, and then is lost for good. This will be the “easier” way to use it, and the one first in demand. “Why not land our rockets with empty fuel tanks, and



refuel on the Moon?" will be the argument.

This use will enable us to get people and things to the Moon sooner and cheaper than the alternatives. And there are alternatives. Land like *Apollo*, with full fuel tanks. This will be more costly, but it will allow landings anywhere, not just at the South pole. More importantly, it will keep the hydrogen on the Moon, where it is essential for closed life support systems.

Another alternative, not as quickly available, will be to use native lunar resources, such as oxygen and aluminum, as rocket propellants. *We have not even started to develop* rocket engines to use that propellant combination, and it may be a major engineering challenge, but there is little doubt that it could be done.

Finally, the ultimate means of lunar launch will be by magnetic catapult, aka by O'Neill fans as a mass driver. In time, one long enough to support the launch of people could (and should!) be built.

We need to recognize the very limited life of this discovered lunar ice, if used for rocket fuel. If we use it in space shuttle-like engines, we can burn it all up with 45,000 tons of oxygen, for a total of 54,000 tons of propellant. Using shuttle engines (the highest Isp that we now have) that will place only 90,000 tons of useful cargo into an Earth return trajectory. At the rate of 200 flights per year for a cargo rocket lifting ten tons, we would use all of this supply up in only 45 years.

I, as one space enthusiast, will argue that this is the *wrong* way to use the lunar ice. Save it to help the citizens of Luna City to get established! However, the realist in me expects to lose this debate to people of "more practical" nature, who will be on the ground first, and will use it to get back home, and *the devil with possible future colonists!*

Fortunately, I see one viable way to recover from this short sightedness. We can mine the asteroids for water, and take hydrogen *back* to the Moon. This is a round-about way of doing things, but it gives me comfort to see a means to recover from the short range thinking that would use lunar ice as rocket propellant.

My favorite scheme is to capture an water bearing asteroid (there are expected to be such) into a highly-eccentric-Earth-orbit (HEEO). Then we can catapult, with a linear electric motor, payloads to the Moon. At first, we will have to use rockets to land this stuff on the Moon. But if we start with a 100 ton rocket leaving the HEEO asteroid, we can land perhaps 55 tons on the Moon. Of this, we might reasonably expect 45 tons to be hydrogen to leave on the Moon. Two thirds of a ton of hydrogen will be combined with 5.3 tons of lunar oxygen to launch the 'tanker' back to the asteroid for another load.

This scheme for putting an asteroid into HEEO is described in more detail in a book just released by Prometheus Books, *Doomsday Asteroid*, of which I am co-author. Since this scheme can place millions of tons of water at our disposal in space, I can rest more easily about whatever may be done with the initial supply of water on the Moon. But lets try to save at least *some* of it for Luna City. *Jim Chestek*

"Asteroids will be our friends  
if we go halfway to meet them."

# The Luna City



## Visitors' Guide - 2097

Musings by Peter Kokh from a visit  
to the Milwaukee Public Museum,  
while on Jury Duty lunch break 9/13/96

### The Function of Museums

For many people, museums are dusty, musty old places filled with assorted collections of useless items with no relevance for daily life. Their loss.

*Museums are meant to be, and are indeed for those in on the secret, well springs of inspiration in dealing with the world of today and everyday.*

People who visit them, even "once in a blue moon", can scarcely avoid leaving their halls without a sense of being enriched with a greater insight into the present as well as a heightened appreciation for the past, and even - here is the punch line - with a more well-founded cautious optimism about the future.

**The Natural History exhibits** help correct our sense of place in the cosmic scheme of things and events, infecting us with deeper respect for our birth planet and its features, and with a greater sense of connection with our plant and animal kingdom fellow travelers in this biosphere of tightly interwoven interdependencies. We see illustrated our calling to serve as stewards for what we have inherited.

**The cultural exhibits** give us new awareness of the contributions to the material and artistic and scientific wealth we all enjoy today - contributions made by those who have gone before. Exhibits of foreign and of primitive cultures teach us that our solutions are not the only ones, and that resourceful coming to grips with local environments and assets is a universal manifestation of the human spirit, its problem solving powers, and its hardship and disaster meeting resilience.

### The Function of a Museum on the Moon

What might a Future Lunar Pioneer Museum display? Two classes of deposit materials are already on hand and need not be shipped to the Moon. Soil ("regolith", the meteorite-pulverized blanket layer that covers the lunar surface) and rock and meteorite samples to be collected from the various representative types of lunar terrain. These can be exhibited in diorama contexts to acquaint museum visitors with the makeup of the lunar landscape both locally and in other, perhaps quite different regions. Other dioramas will bring to light what it is like within the eternally dark lunar lavatubes. The Moon's geological Past, Present, and Future will be unfolded.

Second, there is the now 2.5-3 decades old relics of the half dozen human scouting expeditions of the Apollo Program as well as relics of robotic missions from before, and since.— the museum "hope chest" some shallow-thinking people call "trash".

The purpose of a museum is to visually remember and appreciate the Past in the Present through samples and representations displayed in context. In this manner the roots of local culture and civilization are illuminated, and those who come to study these displays gain a cross fertilization of ideas, inspiration in current challenges to resource-fullness, and confidence that we can always find ways to adapt to current conditions as have all past populations. Visitors come to appreciate the ever surprising adaptability of life and man, the viability and poly-expressiveness of life. Collections and collectibles illustrate the enormous variety of nature as of human possibilities. We learn about the relationships of living ecosystems (natural, and post-human alike; of Earth's planetary Biosphere, and in working (or struggling) off-planet mini-biospheres. The dependence of human life on nature, both geologically and biologically is brought home. Relationships, progress, evolution, revolution, etc. - the never-ending epic of nature, life, and man are

**The Luna City Museum of 2097** should be no different. Starting with the the two classes of natural and human artifacts already on hand,

*the museum's job will be to successfully chronicle the unfolding of the human frontier.*

The visitor of 2097, be he or she a visitor from Earth or a native born 4th generation Lunan, will learn how those who have gone before have built up the lunar civilization of the day, bit by bit, resourcefully and without discouragement through an endless list of challenges, hardships and sacrifices, setbacks and temporary tragedies.

**Early products of the frontier settlements** and there slow steady diversification and growing sophistication and level of attainment will be on display. Arts and crafts, apparel, games, furniture, furnishings, homes, meals, shops and shopping, occupations, amusements, hair fashions, festival trappings, hobbies, schools, musical instruments, street scenes, sports, frontier lifestyles and hardships - these will all be on display in variety, joining displays of the products of heavier and more mundane pioneer lunar industries.

**The special contributions of immigrants** from various terrestrial nations and ethnic backgrounds will also be displayed, their diversity being most strong in arts and crafts contributions. One "wing" of the museum might be occupied by the "Streets of Old Luna City" exhibit. In 2097, native born Lunans may have come to take their culture and now successful and thriving civilization for granted. It will be the museum that will get across to them, how precarious and problematic life was for their ancestors. Humility, inspiration, encouragement, and determination to do the past and one's forbearers proud should be among the fruits of the visit. For museum visitors from Earth, any feelings of superiority and condescension towards the unsophisticated and boorish Lunan rustics should be dissolved. They will be left to wonder if they could have survived the challenges clearly bested by the lunar frontier folk.

### **Periods of Frontier Development**

Visitors will learn clearly the relationship of various intermediate periods of lunar history, and of the arts, crafts, fashions, customs, and products they produced. They will learn

of the first crude faltering lunar outpost and settlement biospheres, and come to appreciate what it takes to make them and the utility systems that work with them function to guarantee continued Lunan existence.

### **Showcasing unsuspected diversity**

"When you've seen one Lunan town, you'll have seen them all!" Anyone who says something like this will say more about his or her own shallow lack of perception than about the Lunar frontier. The discrete and all but mutually quarantined lunar settlement biospheres will sport considerable diversity, as will the architectural solutions employed within, the local "middoor" climates, and local arts and crafts traditions. Sure there will be telltale common threads. But *vive la difference!* To boot, the lunar frontier environment will have fostered a great number of social and cultural experiments and a number of "intentional communities" will have been launched. Of these many way be still-born, many to falter sooner or later, some to survive only by going "mainstream", but some few making their dream a reality, if not quite in the shape and form envisioned by their inspired founders. All this will be material for the Luna City Museum curators.

### **Frontier flora and fauna vs. that of Earth**

Illustrated as well will be the life cycles of plants and animals successfully transplanted into and thriving in Lunan mini-biospheres, no two of these quite alike. But it won't be all about Luna and the Lunar Frontier Republic.

The Luna City Museum will want to gradually build up its collections that will paint an ever fuller picture of what the settlers have left behind. From nature their will be sweeping diorama vistas of terrestrial habitats: seashores and river valleys and deserts and mountains and waterfalls and forests and prairies and jungles and swamps and tundras; plant and animal collections in great diversity, each in ecosystem context. Given the cost of shipment from Earth of physical display materials, audiovisual virtual reality displays will probably predominate.

### **Showcasing the Lunar Economy, Arts, Culture**

But Lunans will also learn of occupations and hobbies, and sports, and recreations common on Earth which have been difficult or impossible to translate with justice in the settings of their new adopted home world. They will catch an idea of what it is like to sail, to soar, to ski, to run under open skies, to picnic under pillow-shaped clouds playing tag with the Sun, of what it must be like to hunt and fish and gather in the wild. They will learn of the quite different suite of natural perils: volcanoes and earthquakes and hurricanes and tornadoes and forest fires and mud slides and blizzards and floods and tidal waves. For Lunans must be shown not only the roots of who they are, to appreciate more fully who they have become.

And they will learn of the somewhat similar and somewhat different challenges and achievements of other Earth-foresakers, those who have chosen Mars, or the asteroids or empty space for their world setting. they must learn of what they have left behind

The Luna City Museum of 2097 is likely to have earned its billing as a pillar institution of Lunan settlement culture and civilization. MEMO



The sterile, airless Moon is already a depository of much cosmic information. Within some lavatube secure from cosmic weather, humans can take a cue and create

### **The Grand Archives of Earth and Humanity**

by Peter Kokh

#### **Four billion years of geological archiving**

Archiving, specifically and specially of the asteroidal and cometary debris bombardment of the lunar surface, and well as of the aeons of solar wind particle buffeting, have built into the magnificent desolation of the global moonscapes an eons-thick scientific archive of inestimable value. As such, the Moon has served, and still serves, as a natural probe of the near solar environment that our human-made robotic probes can only hope to dimly emulate.

The conditions on the fully exposed lunar surface, even more so within the partial shelter of permashade, and best in the yet-to-be-sampled full-sheltered environments within subsurface lunar lava tubes are such that deliberate archiving by humans of both cultural artifacts and vulnerable biological samples and specimens, are a suggested-in-heaven industry of considerable economic value for future Lunan settlements. Archiving will be one Lunan activity with all the marks of a 'vocation' or 'calling'.

Archiving on Earth is, and has always been, an activity fraught with danger, peril, and inevitable disaster. Remember the Library of Alexandria, and the art treasures of Florence lost in the flooding of the Arno, treasures and records destroyed in war, by earthquakes, mud slides, fires, and hurricanes, sadly, even by vandalism. The safest and most secure and environmentally stable environments on Earth can guarantee preservation of objects, artifacts, and records for relatively short times. Sooner or later, all human treasures preserved on Earth will be lost to the forces of human activity, weather, biological activity, and geological forces within Earth itself.

The sight lines of most of us are short. We pretend to worry about a slate-wiping asteroid that may hit us any time over the next few millions of years. Yet no Canadian or Scandinavian loses a night's sleep over the certain revisit of the great ice sheets within the much shorter time frame of the next ten thousand years or so. Most of us care about what carries over to the next generation. After that — we're content to let the next generation worry about it. That is why the inexorable deterioration of the biosphere and of Earth's living ecosystems does not bother most of us. It is sufficiently slow relative to our own personal four score years of life expectancy. *Après moi, la deluge!* ("After me, the deluge.")

But there have always been those with a more eternal vision, from the scribes of ancient times to the Pharaohs to the medieval monks. The upshot is that much of human history has

in fact been carefully preserved despite common indifference. Yet in the long run, what we add by archeological, philological, and historical research only adds to the amount of knowledge that will inevitably be irretrievably lost.

The first task facing would-be curators of the *Musea Humana*, is to find a depository site large enough and secure enough to preserve accumulated human intellectual, industrial, cultural, artistic, and similar wealth not just for a few generations, or even some centuries or millennia, but for veritable eons — yes, for billions of years!

Why! Certainly some for religious reasons based upon fundamentalist literary interpretation of this prophetic text or that, will be dogmat-certain of the impending "end of the world" and see such an archiving task as complete folly and poppycock.

This essay is for the rest of us, not fortunate enough to be blessed with such private certitudes. For us, the reasons why are several. Transgenerational memory, without the prop of preserved reminders (museums and archives) are very short and quite inaccurate. Handing on knowledge of the present and past is one of the sure values we have to give the generations who follow us (along with a well-husbanded environment over which we exercise only temporary stewardship, a weightier burden than most feel or realize.) We need to preserve the record (as well as to add to it!) in a way that will keep it safe and inspirational and educational for generations to come. We have to think in "time capsule" mode.

Beyond the edification of far future descend-ants is the more mystical need felt by even fewer of us to preserve the human, and Gaian, record even beyond the possible death of humanity and Earth life as a whole. For whom? For others, maybe never, maybe just once or twice - we cannot know or estimate - of other origins, who happen by this way in their sojourning through whatever interstellar neighborhood the ruins of Old Earth find themselves at the time. It is a need, a sacred call, to give witness. For what we have achieved and done, at least the modicum of positive within the pile, will give eloquent testimony whatever Creative Agency(ies) that led to and fed our rise as an intelligent species.

The only place to do such archiving for the eternities is on the Moon, in (an) intact lava tube(s) that has(have) already survived inviolate for going on four billions of years — not millions, billions! Any passerby surveying our solar system, in whatever shape it may be in at the time, however distant in the future that visit may occur, cannot but come to the same conclusion. In all this System, lunar lavatubes are the most secure possible repository. (This is, of course prior to the Sun's eventual aging and pre-death expansion into an inner planet melting red giant star before contracting into a white dwarf cinder some billions of years down the road.)

If you follow this line of reasoning, it should become clear that any visitors who have come our way in the distant prehuman past will have seen lunar lavatubes as the only site worth considering if they chose to leave behind some testimony of their passing (whether it be information about themselves or the more Cheshire Cat-like smile of leaving us a record of the Earth and its biosphere of that time, something of a depth and completeness and richness that we could never

hope to reconstruct on our own. Thus Incomprehensibly enriching witness of a visit can be left without prejudice to the "Prime Directive" which may enjoy widespread if not cosmos-wide respect.

When we think of archives, we think of such inevitably trivial data such as genealogical records, and perhaps a more worthwhile mix of artistic and literary treasures encompassing the mediocre and degraded as well as the sublimely inspired. Govern-ment, institutional, bureaucratic and other historical records will be in the trove, to be sure - leaving to the future to find whatever is of value to those mining the hoard. Exhaustive samples of industrial creati-vity and scientific achievement must be included if the whole sample is to have unskewed worth.

Biological records will be a principal part of the whole. Intact preserved samples of every extant species will be priceless in a future in which many species will have become extinct. A geological picture of the ever-changing Earth and an astron-om-ical survey of the solar neighborhood out to galactic depths will help future visitors pin down the epoch in which the archives were created, and the length of time during which they were maintained.

Archive science will spur much inventive-ness as archivers strive to find and use ever better methods of preservation, display, and cataloging. As such, archiving will become a driver of progress of considerable value, creating for Lunans considerable intellectual property value.

At present, all industrial, historical, and art collections and records on Earth are at risk. In many cubic miles of available lunar lavatubes, immune to cosmic and geological events, with constant temperature, absolutely dry vacuum, total darkness and minimal background radiation, we will find our single best bet to keep safe for others the record of what we have collectively achieved, as well as of what nature has left us to steward. Low-maintenance very long life presence/motion-activated solar electric lighting along archive aisles can be installed for use during surface dayspan. MMMM

## MM #103 - MAR 1997 - MARS

### The Moon "and/or" Mars

The Space Advocacy Movement has been so conditioned to the politico-economic reality of fixed and shrinking budgetary pies that taking sides, Moon or Mars, seems the only logical framework for action.

It has always been the posture of MMM that we "have to" find a way to do both, *or* we will end up doing the "winner" badly. This month's editorial and the articles in this issue address this critically patient "choice for both".

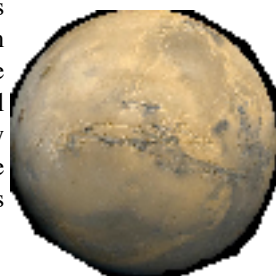

## Outlining a Comprehensive Mars Fossil Discovery and Mapping Program

One or two robotic missions to Mars targeted on the basis of long range site assessment will only yield a "garbage in, garbage out" picture of early life on Mars. - "If it's worth doing, it's worth doing right!"

by Peter Kokh

**Relevant Reading from past Issues of MMM**  
 MMM #83 MAR '95, p. 7: "Searching for Old Life on Mars" [republished in MMMC #9]  
 MMM #93 MAR '96, p. 3: "MMM's Platform for Mars" [republished in MMMC #10]

### "Course Prerequisite" Missions

In college, you cannot take calculus without first having taken algebra, geometry, and trigonometry - these are course "prerequisites" and without a reasonable familiarity with them a student cannot be expected to grasp the essentials of the new course. So it will be, "going to school on Mars" in search of an understanding of its presumably extinct life-forms whose traces may be found here and there by "lucky strikes" in the geological record. We need to prepare ourselves for this study and search by prerequisite work in contextually relevant areas.

Admittedly, we are still discovering ever more and more about the geological context of paleontology research on Earth. But our present picture of Mars is not advanced enough to earn the rating of "sketchy". Any "Report on Fossil Evidence of Early Mars Life" would be of "C high school caliber" if basic geological and topographic precursor missions have not been undertaken, and their data analyzed beforehand. Such precursor missions will be even more important for the success of any proposed human fossil-hunting expeditions to Mars, lest we waste exceedingly expensive "man-hours" on a world it has cost us so dearly to reach.

The following missions would give robotic and human fossil hunters both a better idea of where to look, and a better understanding of what they are seeing, when and if and wherever they find some apparent life-trace:

- ⇒ **Mars Permafrost Explorer & Ground Truth Permafrost Tappers** — Where the water is now, will give a more complete picture of where it was in a wetter past. We now have only Viking Orbiter photos of riverine and beach landforms to go on.
- ⇒ **Mars Topographic Mapper** — With accurate elevations from which primitive basins, watershed divides, and drainage patterns can be sketched. This knowledge will help illuminate how life may have spread across Mars.
- ⇒ **Geochemical orbital mapper** — A refly of the instruments aboard Lunar Prospector might reveal many mineralogical clues to understanding whatever life traces we find.
- ⇒ **Creation of a an "Age Map" of Martian Surface Features** — showing the relative ages of various Martian landforms and strata (argued from morphology, cratering and splash out sequences.)

Geochemical ground truth probes, needed to qualify and calibrate readings from orbit could double as fossil-hunting probes. The same goes for permafrost ground truth probes. But in both cases, we will now have orbital information and on site readings that shed light on what we see with whatever fossil-detecting instruments we have on board.

### **Fossil & Ecosystem Discovery Missions**

Presumably, our consensus international goal in this effort is not just to find incontrovertible on site confirmation of ancient microbial life on Mars. We will want to develop a [an always tentative] picture of its levels of attainment and evolution, of its diversity, even of its ecosystems. And we will want to ferret out which nucleic acids it was based upon, and what systemic genetic similarities and differences there are between presumably native aboriginal Mars life, and presumably native aboriginal Terrestrial life. In so expensive and long-term an effort, we should aim high. For indeed, only the most shallow will find their curiosity sated by an affirmative answer to the first question.

If we agree on this, we must agree that a simple probe or two, however capably instrumented, will hardly do the job. This is a long term, open-ended project of great depth and scope and will require a supportive commitment on Earth with a “cathedral-building” dedication and mentality.

We will begin this effort with robotic probes. but we must realize now, that any thorough investigation will not only require humans-on-the-ground, but humans at the end of sustainably and repeatably short logistics lines. That is to say, this project can only be done justice as part of a continuing scientific investigation of their new “home planet” by humans who will have settled Mars. Not only can we not do it by proxy probes, we cannot do it (well enough) by proxy human scouting expeditions.

But we must start somewhere. *Keep in mind* that we will not be looking for “bones”. It is most extremely unlikely that *native* vertebrate type creatures could have evolved in what is at best a billion year long window for evolution on Mars. We will be looking instead for traces of inorganic body parts like shells and glassy cases (as in our diatoms) or spicules (as in our sponges). We will also be on the lookout for correlative evidence like crawl and wiggle tracks preserved in petrified mud.

Here is a trial balloon proposal for an introductory [pre-settlement] endeavor:

- (1A) ORBITAL detection of likely sedimentary deposits followed by
- (1B) SURFACE rover drill-core sampling for
  - limestone deposits (fossil calcareous shell)
  - siliceous ooze deposits (glass cases, spicules)
  - carbon-rich decay products (slate, coal, oil)
  - patterns that may be fossilized tracks noted by an on board Expert Program as needing further analysis - the rover could collect such samples and when its storage bin was full, deposit them on a tagged site with an activatable beeper, for future collection by human expeditions.
- (2) SURFACE rovers perusing ancient beaches for
  - stromolite beds (fossil algae mats)

### **On Location and Terrestrial Laboratory Analyses**

As we have suggested, Robotic Rover (drill-core) sample Retrievers should have Expert Analysis Programs on their on board computers, and deposit their hoards in tagged, beeper-activatable piles along their route for future collection by on-the-surface human crews. *Only a very few samples* could be rocketed back to Earth, yielding a very expensive and totally inadequate *hit-and-miss* result. The cost-benefit ratio of such a plan deserves rejection. We must, *if we truly want to “know”*, commit to the open-ended incorporation of Mars into the Greater Human World as a human settled frontier.

There is no way to adequately explore what remains of the presumably extinct Martian Biosphere, except by a permanent, onsite, largely self-supplied human population.

### **The Real Prize**

The prospects for recovery of even partially intact DNA-type remains are small. Coming across a Martian equivalent of sample trapping amber is all but inconceivable. But we will not know anything really significant about Mars Life until we know if the nucleotide bases on which its DNA equivalent is based are the same four upon which all terrestrial life is based [A-adenine, T-thymine, C-cytosine, and G-guanine] or upon a partially [25%, 50%, or 75% commonality] or wholly different set. Stereo mirror versions of one or more are also possible. The implications of the answer, should we be able to uncover it, will be enormous.

IF the nucleotide base set is wholly the same, the implications will be either that this is the only workable possibility, or that both Mars and Earth have been seeded from the same pre-biotic source and are fraternally related or that one is an offspring of the other.

IF Mars’ nucleotide base set is even partially different, the implications for the cosmos-wide diversity of life beyond “life-as-we-know-it” are profound. In that eventuality, we would be *even more driven* to discover *everything possible* about this “different Genus of Life” on ancient Mars.

### **Putting Together the Big Picture**

Whatever the truth be about genetic meta-type commonality and difference between Martian and Terrestrial Life, we will want to know how far along Martian life got before geological forces prematurely closed this epic chapter.

- In terms of diversity of and within phyla, families, genera, etc.
- In terms of complexity. We have evidence of bacteria type creatures. Did true cellular organisms evolve? Colonial organisms?
- Outline of the sundry “next logical evolutionary steps” for which evidence is not in hand but needs seeking for a hard positive or negative finding.
- Geographic ecosystem differences and biome mapping
- Comparison of Martian and Terrestrial start up conditions (atmosphere gasses, pressures, temperatures, hydrospheres, cycles, seasons, tides etc.)

This is a partial sketch of work that will consume and absorb all the energies of university Mars-biology departments into the indefinite future.

## Establishing Provisional Paleontological Preserves



So we begin our search for answers by robot probes. What should we do to protect sites in which they make positive finds? Those sites that by their geological nature promise to yield much more sample “evidence”, we may want to designate and protect as “temporary” “Do Not Disturb!” set-aside zones, at least until reasonably thorough on site “human expert” perusal has been undertaken. If temporary paleontological preserves were established only on the basis of sound evidence, very little of Mars 55 million square miles ([as much as all the dry land on Earth!]) would be excluded from the first round of frontier development. As these sites became more thoroughly explored by paleontologists, and the picture of *local* Mars life becomes more complete, this protection might be removed. Thus a “sunset” provision with renewal procedures could be part of the initial legal proclamation.

This *Section* of a future Mars Frontier Treaty could be agreed upon separately, well in advance of consensus or compromise on other more politically and economically controversial sections.

There is work to be done, work that in the end will absorb many people over generations. If we do not commit to doing it, it will be to our eternal shame as a sapient species.



## Feasible Goals of Assistance in the “Opening” of Mars for an early profit-seeking Lunar Industrial Settlement

by Peter Kokh

### Relevant Reading from past Issues of MMM

MMM # 18 SEP ‘88, “A Strategy for Following Up Lunar Soil-Processing With Industrial M.U.S./c.l.e; the importance of the Lunar M.U.S./c.l.e plan for the opening of Mars” [republished in MMMC #2]

MMM # 62 FEB ‘93, “The Triangle of Trade: Economics behind Lunar Settlement and the Opening of Mars” [republished in MMMC #7]

Suppose [humor me!] the “powers that be”, and/or any free enterprise forces that may choose to ignore them, do decide to begin resource-using lunar settlement in advance of any serious effort to open Mars *as a frontier* (whatever the timetable for an initial human exploration sortie). Of what assistance could [an] established industrial lunar settlement[s] be to the eventual pioneers of Mars?

**(1) The Moon is a place where most of the systems and equipment needed to make a Mars outpost work successfully, can be field-tested — under real sustained live-use conditions — and debugged within easy range of resupply, repair, and rescue** from Earth. This includes:

- recycling life support systems
- power plants
- regolith moving equipment
- shielding systems
- mining and processing equipment
- construction equipment and methods
- surface transport systems
- pocket factories
- pocket hospitals — and more

To risk first sustained use of such systems on Mars where resupply, repair, and rescue if needed are as much as two and a half years away would be reckless bravado of a kind deserving no applause, should the gamble pay off. At stake are human lives.

**(2) Early lunar industries** will concentrate on the manufacture of more Massive, Unitary (items needed in considerable quantity), and Simple components to complement and/or be mated to more Complex, Lightweight, or Electronic components manufactured on Earth - the so-called “**M.U.S.-c.l.e. strategy**” for getting *the greatest cost reduction in the import burden from the smallest import investment of capital equipment* - the fast road to off planet industrialization. The punch line is that anything lunar pioneers can make from such starter industries will be available for export at a competitive advantage over admittedly more sophisticated terrestrial manufactures, to all space locations: LEO, GEO, L5, the asteroids, — and the Mars system. If Martians choose and order the equipment they need designed, manufactured, and sourced by the Lunan “M.U.S./c.l.e. system, they will save money. And for early Martian pioneers, with few if any ready-to-sell exports, saving money will be make-or-break important. The same buck will buy them more and take them further, with Lunan pioneers to order from. “Frontier-made, tougher, simpler, less breakdown-prone, easier to repair, cheaper.” That’s quite a sell.

### Such exports might include:

- Shells for early Mars habitats, the more sophisticated lighter weight innards to have been manufactured on Earth, for outfitting completion en route to Mars (keep ‘em busy).
- ready-made portable shelters and sheds
- aerobrake shields
- initial furniture and furnishings until a local manufacturing capacity is established.
- tanks for tank farms (volatiles)
- simpler, heavier components for processing and manufacturing equipment, assembled en route
- greenhouse components, etc. etc.

**(3) The availability of Lunan industrial know-how** and field-proven methods will prove invaluable. This kind of intellectual property export could include:

- MUS/cle design, manufacturing, & assembly techniques
- Lunan experience in creating variety & diversity for small markets.
- Manufacturing of local building materials and construction and assembly techniques
  - fiberglass/glass matrix composites
  - fiberglass reinforced local concrete
  - alloy ingredient substitutions

- ☑ regolith derivatives
- ☑ cast basalt
- ☑ site-appropriate ceramics
- ☑ fiberglass/sulfur composites

All of this expertise will already have been field-tested in a setting that permits intervention, and rescue and resupply and expert staff relief.

**(4) The availability of Lunan field-experienced experts for assistance in set up, problem-solving, maintenance and a host of many other “experience helpful” positions.**

Would-be Martian Frontier pioneers, if they have the benefit of standing on the shoulders of Lunan pioneers who have preceded them, will have an incalculable advantage over those who would attempt to open Mars “inventing the wheel from scratch” in a setting were the slightest setback - equipment or systems failure - could well prove fatal to all. ~~TTTTT~~

## Tempering Enthusiasm for the Red Planet as “The Next Human Frontier” with Personal Honesty

As the time for enlisting gets ever closer and closer and the window for “changing one’s mind” shrinks towards “the point of no return”, an outbreak of widespread “Cold Feet Syndrome” is sure to occur.

by Peter Kokh

### I. Being Honest About the Cold

A cherished dream dies hard. We have known for a couple of decades now, that the real Mars is a much colder, drier, thinner-aired world than the one we used to dream of colonizing, than the Mars of Lowell and Clarke and Heinlein and Bradburry, the Barsoom of Burroughs.

We had ourselves prepared for thinner air, say that of Earth’s high mountain plains 20,000 feet up. Alas, Mars’ air is more comparable in pressure to Earth’s at 125,000 feet, more than four times the height of Everest. We had ourselves braced for cool Martian summer days in the 60’s (F) and winter nights perhaps the same number of degrees below zero (F). But Viking meteorological stations showed a year in, year out pattern much much more bone-chillingly cold than that. Mars has no Florida.

We still don’t quite believe it. For the cold is “invisible” - there is no surface ice or snow - away from the polar regions - to give us a clue. We look at the Arizonesque scenery and we expect Arizonesque temperatures. Mars *looks* seductively tolerable. But how many of us are really hardy enough to handle even the Martian summers, let alone the winters. Doubly long by Earth standards, and doubly cold, will they not wear us down, rob us of our hope of a spring. when it’ll be merely quite cold, not bitter? Even us hearty northern snowbelters can tolerate our own winters, just, because we know they only last a few months. In Alaska, the longer winters translate to a higher than (national) average suicide rate. Imagine what that statistic will be on Mars, and the price it will exact on any settlement. Summer will at last come, and it

won’t be much to enjoy, even by mid-Siberian norms (and I’ve experienced those first hand). Yes, we have people in Antarctica who have withstood comparable temperature cycles. But none of them has been sentenced, or has sentenced himself to experience none better the rest of his life.

Ah, but there will be compensations! The chance to start fresh, where all the ladder rungs are open, *where all the rules can be rethought*, where *traditions* will be what we make them from scratch! On a world too distant to suffer meddling interference or haughty paternalism from bureaucrats and politi-cians on Earth. Yes, yes, yes — but! The chance to pioneer freely on Mars will be there in full.

But the interference-foiling distance is a sword that cuts two ways. For it makes rescue and bail out quite impractical as well. Our Martian wanna-be’s are going to have to swim or sink - quite entirely on their own. This defining aspect of the “Martian Condition” will see the making of many episodes of real heroism, heroism perhaps of epic proportions. But these glories will be perhaps a bit too-well-salted with tragedies hewn by the same sword.

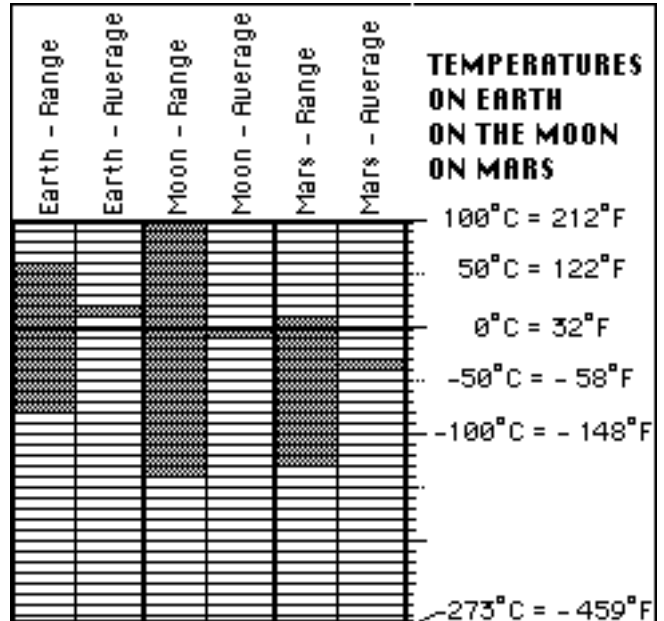

KEY: Absolute Zero at bottom.

While both Earth and the Moon lie the same distance from the Sun, Earth’s atmosphere and oceans moderate the temperature daily and seasonal differences whereas on the Moon superficial (surface only) extremes are found.

For practical purposes the real temperature of the Moon, a couple of meters/ yards down is a steady cool -4° F = -20° C. This is 62° F = 34° C cooler than the Earth whose oceans act as an enormous heat sink/thermal flywheel to keep Earth significantly warmer.

Mars’ thermal flywheel is non-existent, and the average subsurface soil temperature is 50° to 60° F colder than on the Moon, more than 100° F colder than on Earth. NOTE: the *highest equatorial mid summer mid-afternoon* temperatures on Mars are *below* the mean *global* temperature on Earth (58° F = 14.4° C)

Both habitats *and suited individuals* on Mars will need insulation and reliable heating. Heat failure in either case will pose a life-threatening emergency. (On the Moon, the poor conductivity of the soil allows body heat and human activity heat to carry the load quite well.)

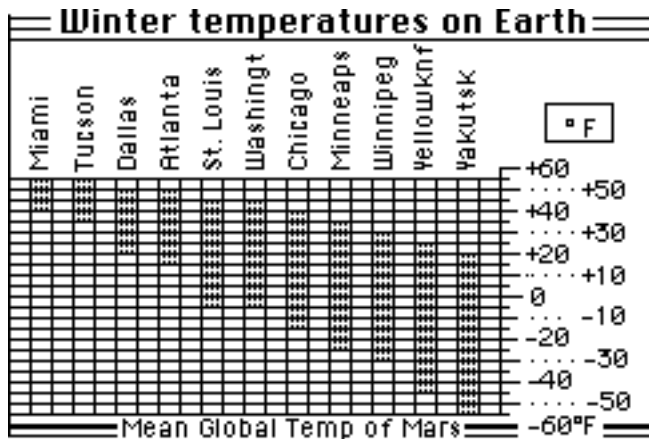

Even the hardiest of us will find Mars "too cold"

Martians, like Lunans, will be pioneering from scratch, forging their own building materials, making their own fertile topsoils. Nothing on the shelf, nothing in the stores - unless it be imported from Earth or Moon. Much as Lunans will perhaps already have experienced, smoothing the overly many rough edges of this naked-born frontier will take ever so long. But it will get done.

How many of us declaredly ready to pack our bags are being honest with ourselves? How many of us have already made life style choices and changes in favor of *less* hardy, *less* rough, *warmer* and *smoother* and *friendlier* conditions and settings? That's not a good sign.

Mars IS a place for humanity to pioneer, to "frontier", to start afresh, to redefine itself anew. But when the time comes for irrevocable decisions, for signatures on the dotted line, for beginning a journey across the void from which for most there will be no return, all that real opportunity will lose its appeal for most who now "*would go*" — now, while the saying of it is cheap since there is little chance of our bluff being called, not even by ourselves.

Nothing will endanger our collective hopes of opening the Martian frontier, more than a collective outbreak of "cold feet". We are setting ourselves up for this by continuing to look at Mars with rose-tint glasses, "seeing Arizona in the merely Arizonesque." Without honesty, we can hardly prepare ourselves or others to take up the dream. Let's be honest!

Mars is a world whose air is too thin to screen out the micrometeorite rain, too thin to shield from the Sun's burning, tissue-destroying naked ultra violet rays. Mars is a place where one cannot turn his back to the Sun to feel the warmth. It is a place of deceptive skies and dangerously invisible cold. A world in some ways more forgiving than the Moon, in other ways less so, if only because its appearances and meager resource pluses may prove disarming.

#### Past less than popular frontiers

Not every frontier on Earth has been a clear success story. Many a frontier has proven less than popular, more challenging than its would-be pioneers were ready for, too unattractive to lure more than a scattering of pioners, most of whom may have had no real idea of what they were getting themselves into. Consider these examples.

- **Siberia's** 6 million square miles of Taiga and Tundra are

easily the most populated of these frontier regions, but this has been achieved by very high incentives and considerable forced relocation. The region has 30 million people at the outside. It is much warmer, wetter, more fertile, verdant, full of wildlife, ready building materials (wood), and more resource-rich than Mars. So if it has taken a century to build its population to this point, at the end of a relatively short and easy journey from the friendlier more civilized and sophisticated western regions of historic Russia proper, what grounds does that give for a belief that we could see 50 million pioneers on Mars within a century of its opening?

- **Yukon & Northwest Territories:** Similar to much of Siberia, is Canada's great Far North, with a combined size half that of the continental U.S.. Again resource and life-rich, within 2 hours reach by air of Canada's major cities, but after a century plus home to less than 50,000 hardy people. Major Canadian Arctic islands, like Baffin and Ellesmere, veritable Floridian oases by Martian standards, are populated mainly by prehardened Eskimos.

**The Falkland Islands:** This haven of the South Atlantic, perennially disputed by Argentina and Britain (incumbent landlord) are treeless and wind-swept but have other vegetation and wildlife, and are surrounded by food-rich waters, and are much more "balmy" than Mars. After centuries, they are home to less than 5,000 souls.

**South Georgia:** 800 miles SE of the Falklands, this thousand square mile isolated refuge from civilization is home to few humans, many rats.

**Greenland:** apparently this greatest of Islands had green-clad shores fringing its glacial interior at the time of its discovery by vikings a millennium ago. True, 80% of this nominally Danish autonomous country is covered by a think ice sheet. But the Montana-sized ice-free coastal areas boast only 60,000 heavily import-dependent citizens.

**Spitzbergen:** in the no man's sea between the North Atlantic and the Arctic Oceans, well to the north of the top of Norway who owns them, these islands the size of West Virginia are home to the most poleward (78°N) of real human settlements (i.e. excluding the family-free caricatures we see in the Antarctic), namely Longyearbyen with its "suburb" Barentsburg, counting together some 2,000 coal-mining pioneers, mostly from Russia. When's the last (or first) time you saw a blurb appeal to help open the Spitzbergen frontier? Beat the rush! Compared to Mars, Spitzbergen is a paradise!

**Antarctica's shores and fringes:** By all salient characteristics and measures, only the night-day pattern is friendlier on Mars than in Antarctica. The temperature ranges and seasons are similar, except in length. Antarctica's air is oxygen sweet, ready to breath through a warming filter. It's winds pack more windmill-turning punch. It's dry valleys sport lakes with algae life. Birds abound. Its shore-washing waters are more abundantly teeming with food-fish and sea mammals than any on Earth. It has oil and coal and iron ore.

However remote by description and lore from the familiar rest of Earth, Antarctica is not that far away anymore. Base personnel are on the Internet and FAX lines, and the two dozen some outposts of several nationalities are all reachable



within a couple of days through most of the year.

But there are no real settlers, no pioneer families. Treaty forbids this you say! Give me a break! If people wanted to go, they would. Since when have treaties not been made to be broken?. — People don't want to go — in droves, in an eloquent unanimity by default - not to this god-blessed, spectacularly beautiful world-apart within our world, a place which viewed through equally untinted glasses is far richer and friendlier and more beckoning than Mars. The difference is this and this only. When it comes to Antarctica, we are being honest, when it come to Mars, we are still prisoners of romantic myths.

This sampling of not-so-popular frontiers gives little comfort or credence to those who expect hundreds, thousands, or millions to flock, Oklahoma style, to Mars once the planet is pronounced "open". Yes , some *will* volunteer, and actually *go through with it*, and work the Martian Frontier *as if there were no return* - for there may well be none. But those recruits who do not get cold feet at the last minute will be "the few, the proud, the Martians". They'll come mostly from already hardy subarctic and cold desert populations. Will they be enough to provide Mars with a critical mass? Maybe not.

The time to be personally honest is now.

## II. Being Honest about the "Outdoors"

Few people other than agoraphobes do not love the **outdoors** on a fair, sun-glorious day. But some of us have a soul-need to spend significant quality time outdoors, walking, driving, playing sports, or just relaxing on the front porch or rear deck. The rise of Television and the Internet has not quenched that thirst in all of us, only in some of the already dead.

Then there is that fraction of the population who plunge into outdoor hobbies necessary for their sustained mental balance. Some of these we will be able to transplant to Mars, up to a point: motoring, hiking, rock collecting, even flying. Others, we can forget - at least until we can build cities or recrea-tional parks within huge macro-structures that create modest "middoor" environments: sailing, bird watching, hunting, fishing, etc. Most of these outlets for the soul will be unavailable to the early pioneer. As they are the ones who must come first, who must indeed "pioneer" and set up shop for the dreamt of Martian civilization to come, the question for Mars enthusiasts returns. "Am I being honest with myself? Would enlisting mean sacrifices that over time I would find so unbearable as to unbalance me? Each must answer that question for himself.

The time to be personally honest is now.

## III. Being Honest about the "Boondocks"

The outdoors isn't all pioneers will be called upon to give up. Mars is a world physically large, its surface comparable to all Earth's continents together. But sociologically and economically and opportuni-stically it will be a very, very small "world". One or more really small towns where everyone knows everyone else, from which there is at first no change of human scenery. Are you a city guy or gal, or a country one? Or like me, someone who needs to spend time in both? could you handle being stuck in a small ultra rural hamlet the rest of

your life with no more than time-delayed electronic access to the greater world of man? Even the most content farm boy likes to sample the big city lights once and a while.

Those of us who revel in the diversity of our World, "big W" (not only the cities, towns, cultures, nations, etc. but the plant and animal wildlife, ec.), may find "the little w" unbearable. Earth will no longer be, as on the Moon, a TV or radio set on-off switch away and available for a two week vacation for the price of a little exercise in the gym followed by a couple of days' travel each way. The new Martians will have only imported videos to remind them that there is/was more to the universe they have chosen to leave behind. On Mars, returning "home" could be as much as a two and a half year undertaking - one way.

We are used to a world where everyone does not know everyone else, where it takes more than a minute to read the days news, with an inexhaustible supply of strangers to meet, diverse rags to read, and of stores to shop. Mars will be, at first,"the ultimate small town, all alone on a big super remote island."

The time to be personally honest is now.

## IV. Earth need not be the only source of Volunteers for Mars

In contrast, for established or native-born Lunans, Mars may have all the siren appeal of an Oasis. Lunans will already have weeded themselves out, have become accustomed to not being able to go outdoors without a space suit, used to spending their lives entirely in air-managed micro-environments, accustomed to the recreational tradeoffs they have had to make, accustomed to the "boondocks". Here on the Moon, where such weeding out is a much less expensive proposition, a population will emerge that is well adjusted, creative of its own diversity, recreational and artistic opportunities, of its own diversions and "get-away" escapes, able to work the frontier free of paralyzing depression.

Some long-time and native-born Lunans will find themselves ready for a new challenge. To them, Mars will appeal as a veritable Mecca. The cold, the isolation, the restrictive living - all this will be either nothing new, or scarcely intimidating. There will be tradeoffs they have to face and accept in making the move. Mars is physically and logistically and interactively two magnitudes (a hundred times) more remote from Earth. Balance this against the consequences and perks of a thin atmosphere, a little more gravity, freedom from the tyranny of a gray toned palette, a lot more carbon, nitrogen, hydrogen, and water, a more Earthlike pace of sunrise and sunset, a somewhat more relaxed lifestyle.

Unlike people who have never been off Earth before, Lunans will come to Mars ready for the job, experienced with the rough edges of the frontier, full of depression-resistant optimism and enthusiasm. No Earth-born Earth-bound population offers to be as fertile a source of Martian pioneers.

Again, it is the pre-hardened Lunan pioneer, ready for fresh challenges, who will be able to handle such deprivations - he or she has already made them (or never experienced such activities) and survived in good psychological health. Pioneers of this future national background (dare we say it) stand to be the born-leaders on the Martian frontier.

*If in impatient urgency, we attempt to open Mars before there are Lunans to help, we risk setting up history's most expensive ghost town.*

That is we tempt failure, tempt it big time. "Pride goeth before the fall." Not to forget one of the most primary cosmic laws as it applies to the affairs of mortals: "Impatience always backfires"

This consideration is in itself, a weighty reason for beginning lunar settlement first, what-ever the timing for a first "flags and footprints" exploratory bravado mission to Mars, likely to be as much a false start as Apollo, half a century earlier.

The time to be personally honest, and to be honest as a space advocacy community, is now. For the National Space Society and its Board of Directors, It is time to return the pendulum to the center. Yes, we must open the Martian Frontier! - In sequence!

Granted, government[s] probably can do one or the other and not both. Let the government[s] concern themselves with Mars, after it[they] have set up a politico-economic regime and amply-incentivized rules of the game that will entice free market enterprise to open the Moon. Ultimately, only profits can open the frontier, and they are far, far likelier to come from, or via the Moon.



**Relevant Reading from past Issues of MMM**

MMM #92 FEB '96, p. 7: "Who Will Pioneer"  
 MMM # 93 MAR '96, p. 1 "IN FOCUS: Mars will require a hardier breed of pioneer"  
 [republished in MMMC #10]

**MMM #104 - APR 1997**

***Clones and the Space Frontier***



"Clones", a standby staple of science fiction writers for generations, are suddenly not science fiction anymore. Forget the stale nightmare visions of Nazi super men. Clones may have an entirely different range of usefulness in opening the space frontier.

Tom Heidel tells us what clones are, and what they are not, and how *your* clone "may someday boldly go where you have never gone before". See "Human Clones and the Opening of Space" below.



***Preserve the Lunar Ice Record:  
 Before we do anything else with lunar water....***

from Bryce Walden, Oregon Moonbase

Find a very few kilos of frozen water on the Moon and right away users are lining up with their buckets. The debate seems to revolve around mining lunar ice for rocket fuel vs. mining lunar ice for life support vs. mining lunar ice for industry, etc.

I would like to express a caveat to these developmental uses of lunar ice in the name of science. On Earth, water is always relatively new, the evaporation-rainfall cycle erasing its history. Ice on the Moon, thought to come from impacting comets, is ancient and pristine. Before we go tearing up the ice fields for any other use, let's be sure we preserve the information locked in the ice and in the deposition record. Scientific analysis of ice cores taken from the Moon will tell us about the Moon's and the Solar System's ancient history, a record unlike any other available to us.

This information is a valuable and rare resource. Mining and use of lunar ice will erase this resource. So, before filling our buckets and hauling away the rare lunar ice, first let us preserve a few cores of the material in its natural state, a library of past events and a record that can be studied by scientists for years afterward. It would be a crime to destroy this unique information without some attempt at its preservation.

<BW>

**Ice Man**

***Following Up Clementine's Eureka***

by Peter Kokh

In our IN FOCUS essay in MMM #100, Nov. '96 "Time to begin brainstorming *Lunar Prospector II*", our recommendation called for reflights of the polar orbital mission profile using instruments similar to those aboard *Lunar Prospector [I]* of much greater resolution. Next on our wish list was an orbital probe instrumented [wide-aperture radar] to detect large nearer surface voids i.e. lavatubes. In the few months since, there has been the announcement of a positive find of water ice at the Lunar South Pole by *Clementine* scientists using ingenious application of instruments not originally intended or maximized for the detection of water ice. This major development has given us major incentive to rethink the question of what should come next.

**Assaying the Resource**

The general knowledge that there is a major volatile reserve and resource at the south pole does not in itself give us enough information to even begin plan intelligently how to access it. We do not now know how extensive a permashade area is covered with ice, nor whether despite *Clementine's* failure to detect any, there are similar reserves at the North lunar pole. There are no reasons other than topography (which affects the amount and placement of permashade) why there should be any difference in the capture and retention rate of the two poles for comet-impact derived volatiles.

Nor do we now have more than anecdotal back-of-envelope guesstimates of just how thick the deposits are either in specific instances or on the average. Nor how impure the ice is: how much carbon oxide ice and other frozen volatiles are mixed in with the water ice, or with how much regolith “sand” and grit it is composited. We can only assume the ice’s temperature and hardness - which will affect the design and engineering of any mining equipment needed to access these reserves.

Only a rover can tell us how uniform the deposits are, or how this correlates with the amount and monthly duration of ambient reflected sunlight. Or if the %age included carbon oxide ices varies according to some pattern that can be predicted from environmental clues. Any such information would be of great practical engineering and scheduling importance for proposed mining operations.

Scientifically, much more is to be learned about the age of the ice and the state of the Solar System at the time these deposits were laid down, presumably through cometary impacts. Scattered drill core sampling and ice surface micrographs might prove invaluable indicators.

Clearly, what needs to come next is not, as we had first proposed, another in a series of orbiting probes, but rather a squadron of landed “ground truth” stations and/or rovers, that will be able to adequately “assay” the ice, and fully qualify and quantify it. — call them **Ice Man I**, Ice Man II, Ice Man III, or whatever you want. Our need is for on-the-ground equipment that will give us the knowledge to engineer the mining and processing equipment and attendant infrastructure to begin tapping this resource intelligently. Before we have results from these Ice Men landers, any development scenarios we put together will be proportionately half-baked.

#### **Private Enterprise can foot this bill**

David Anderman, a tireless and undiscourageable space activist from California, active in the National Space Society, Space Frontier Foundation, and the California Space Development Council, worked hard to write and then shepherd through Congress the **Lunar Data Services Purchase Act**. His aim was to provide funding for a private *Lunar Prospector*.

Along came NASA’s “smaller, faster, cheaper” *Discovery Mission* opportunity and the award, against stiff competition, to the Lockheed- sponsored *Lunar Prospector* team. So as it turned out, the Act was not needed to bring this lunar polar orbiting chemical mapper to a long awaited reality. But the Act is still in place and can be used to fund a follow up. According to Anderman’s strategy, Congress would pay X dollars to any agency or outfit that does the specified mission *and comes back with the data*.

**Need for Follow up Legislation** - To actually lure a company or agency into putting together any such probe and mission, the financial reward has to be high enough. So what if Congress is too stingy, and offers say a \$30 million reward for an effort that will cost much more than that? Are we dead in the water? Not necessarily — not if we don’t put all our eggs in this one revenue basket. With Congress’ assent, but without its financial risk, the pot can be sweetened considerably by the awarding of **royalty rights**. (MMM credits this idea to Bob Zubrin, charismatic architect of the Mars Direct mission scenario and now Chair of the NSS Executive Committee.)

Simply put, any mining or development company subsequently harvesting a surveyed and assayed water ice field would have to pay a set per ton royalty to whomever did the assay of that particular field.

An option would be to give the assaying agency itself the primary **development rights** to the assayed ice field, theirs to hold, use, or sell at whatever price the market will bear. There would have to be hefty civil and criminal penalties for substantial misrepresentation of the quantity and purity of the ice deposits in question.

In either case, the proposed legislation does more than provide an economic formula sufficient to attract execution of the desired task. It establishes an economic “terrace” which will work to encourage subsequent development of the resource deposits to be assayed. As such, this legislation would provide the very first breakout point towards the long-anticipated space-based economy.

But actually, without realizing it, David Anderman’s Act and *Lunar Prospector* which will fly anyway, have already broken significant new ground. Together they mark the first break in the exploration paradigm, from the search for pure knowledge to the search for useful resources. Indeed, this is why we first proposed the name “*Prospector*” for what was then the Lunar Polar Probe Project back in the fall of 1988 - to encourage a paradigm shift from exploration to prospecting. The legislative follow on outlined above would now open a third dimension:

*from exploration to prospecting to development*

#### **What about “the Outer Space and Moon Treaties”?**

Don’t they preclude any such arrangements? As the witticism goes, it’s much easier to win forgiveness than permission. He who hesitates is lost. The meek may inherit the Earth, but surely, the timid will not do likewise. We need to “just do it”, establish a *fait accompli*, and then fight to have what we have done upheld, and the treaties adjusted or reinterpreted to fit reality. Inappropriate treaties have never stopped reasonable development before. If nervous Annies interfere on behalf of misbegotten paperwork and succeed in thwarting lunar development, it will be a first.

We have to believe in ourselves, and in our cause, and have the conviction of what we are doing. Lunar resources have the real potential of making possible “a Greener, Cleaner Earth” for the benefit of all through the accessing of clean, environment-safe space-based power. (Electric power generation is in gross aggregate the single dirtiest thing we do on this Earth!) It is not we who would follow this course, but those who would stop it, who ultimately would bear the guiltier conscience. However “benign” the language of the treaties, a proper sense of smell detects the hidden rat. We must have the gumption to proceed *regardless* — we owe that to everyone, not just ourselves. It is the World’s poorest billions who stand to gain the most.

**Conclusion** - So our argument goes from the need to answer the questions that *Lunar Prospector* can’t address, to the kind of missions that need to come next to the kind of legislation we’ll need to ensure the job gets done. We have a bill to write, establishing royalties and/or development rights; then shepherd it through Congress. The time to begin is now. <MMM>

# Ice Logistics

## Getting lunar polar water ice to thirsty industrial settlements and bases elsewhere on the Moon

by Peter Kokh

Why take the ice anywhere? Why not build our lunar settlement/outpost where the resources are — at the south pole? Aha! Because that is *not* where the resources are! Man does not live by water alone, nor by water and sunlight alone. Is Chicago astride Minnesota's Messabi Iron Range? Is Los Angeles on Alaska's north slope? Is Phoenix on a great river?

This overly easy "why not" flows from an underappreciation of the industrial-export opportunities on the Moon. In so far as they rest on raw materials, *water is an absolutely essential — yet only auxiliary element*. Much greater quantities of iron, aluminum, titanium, magnesium, concrete, glass, glass composites, and ceramics will be involved. We'll need them for building and furnishing the lunar settlements themselves, and for export of the same products to other off-Earth destinations. We'll need them for manufacturing solar power arrays, on the lunar surface, in space, or both. We may need them to support Helium-3 mining operations once/if that energy scenario becomes engineering reality.

Both lunar poles sit in "highland" areas, rich in aluminum, magnesium, and calcium. Oxygen and silicon are locked in the rocks everywhere, but if we want iron and titanium, we'll find them in greater abundance in the "mare" [MAH' ray] areas, the frozen lava sheet "seas". We'll need both suites of materials to make glass composites. Do we take the Mountain (all these other ores) to Mohammed (where the water ice is) or ought Mohammed to seek out the Mountain?

Clearly, it is folly to put a lunar industrial site *anywhere but* along a **mare/highland "coast"** strip, where highland and mare suites of materials can be accessed with equal ease. That leaves us with *countless options - none of them near a pole*. The closest coast to the north pole, that of Mare Frigoris, is some 600 miles away. The closest coasts to the south pole, where ice has been confirmed, those of southern Mare Humoris and Mare Nectaris, are more than twice as far removed. If all we are going to do on the Moon is set up a fuel depot, then the South Pole seems the spot to be. If we are going to do more, we will need a south polar ice-mining town — to play the *supporting role*. But *we have to transport the ice!*

We'll find that the tension between polar and more equatorial mare/coastal sites is an extremely pregnant one for lunar development. The simpler solution, then, is clearly not the best one — but that should surprise no one.

### Form and Function

We can transport the polar water ice in three forms:

- as crushed or **chopped ice** - on conveyors over the short haul, in covered trucks for long distance. This would be the raw product of simple mining.
- as **liquid water** - in heated / insulated pipelines or left to refreeze in tanker trucks. Melting will drive off

most other frozen volatiles with lower boiling points like carbon oxide ices, leaving mostly water, and refrozen, much purer ice.

- as a **gas** — not H<sub>2</sub>O "steam", but chemically reacted with carbon (there should be an appreciable "clathrate" fraction of carbon monoxide and carbon dioxide ices mixed in lunar polar ice) to form **methane, CH<sub>4</sub>**, to be reacted with local oxygen in fuel cells at the pipeline destinations to reform pure water, carbon dioxide needed for plant growth, and nightspan energy.

- Transport of raw chunk ice will require the least extensive installations at the mining site. Just mining basic equipment (drills, mechanical picks or whatever) and chunk ice-moving equipment and power sources needed to make them work. Turning the ice into purer more usable product could then be done at market destinations.

- Liquefaction with possible refreezing, does most of the requisite "ice-processing" at the mining site. It may or may not call for more elaborate mine to market infrastructure.

Needing no overland infrastructure but more capital equipment at both ends are mated pairs of mass-drivers and mass catchers flinging and catching mass-equalized balls of purified water ice. Such a system would be considerably less destination-flexible than any other alternative, and would tend to concentrate lunar industrial development without regard to other salient factors, missing many chances to spread settlement and development around the globe.

Suborbital hopper bulk ice carriers would make for more flexibility. They could be powered by all-lunar fuels such as liquid oxygen and iron fines pulled from the regolith soil with a magnet.

- Long term, gasification, and the opportunity it provides for fractional distillation into pure substances (water, carbon monoxide, carbon dioxide, and other volatiles), is the most attractive option. This scenario would mean building a "refinery" of sorts at a polar site, uninsulated and unheated pipelines, with nearly complete recovery of the energy expenditures involved in a very useful way (for needed extra nightspan power) at the various pipeline terminal delivery sites. Fed chunk ice by trucks or conveyors, the refinery would be centralized in a topographically logical location to serve as a multi-branch pipeline head. Or there could be several.

### Enter Infrastructure

Pipelines are infrastructure. They require Rights of Way, topographically logical routing, and periodic pumping stations and branch option T-valves. Roads are a more flexible infrastructure - easier to "T" into, but needing wider Rights of Way. Road and pipeline would likely parallel one another, possibly accompanied by a power transmission line.

Any of these options will establish corridors of clearly "improved" real estate. The investment needed to create them can be amortized from profits in the sale of ice/water/methane and from the sale of in-corridor "improved" frontage properties.

As such, pipeline and road corridors "invite" a **Land Grant system** that would promote additional development.

[See Alan Wasser's article on pages 9-11 in last month's MMM.] For this reason, the Rights of Way granted ought to be overly generous, some miles wide, exact figure to be determined. As other ice fields are brought into production, the mining companies and transshipment companies that serve them would pay fees to "T" into roads and pipelines built to serve the first field to be opened. This would create a strong incentive to accept the extra up front costs (developing and field-testing the necessary equipment) of being the "ice-breaking" pioneer.

These Right of Way corridors are likely serendipitously to provide access to both mining and scenic "areas of opportunity". If nearby areas of especial mineral wealth or spectacular beauty are pre-identified, they may well act as economic "mascons", pulling the proposed transport corridor in question off its most topographically logical route.

### A Kingpin Role for Ice Logistics

"Ice Logistics" will be a critical element in lunar economic development. The form in which mined ice is transported to various lunar markets will play a very important role in the way lunar development unfolds and diversifies as well as in the way human presence is globalized around the Moon. It will codetermine where settlements and outposts are established, even the order in which they are founded, and the rate at which they will grow.

Just as importantly, Ice Logistics is sure to become a central focus of early lunar politics, much as a series of key decisions in urban and rural electrification and electrical power transmission shaped and focused local, state, and national politics in this country during the last part of the nineteenth and the opening decades of the twentieth centuries.

Thus it becomes clear that the ramifications of the existence of economically significant amounts of lunar polar ice — when contrasted to the ramifications of the previous "wisdom" which discounted that possibility — are enormous, in their pyramiding, for the future of the Moon and its place first in a Greater Earth economy, then in a Solar System wide economy.

Suddenly, it is very interesting! <MMM>

## HUMAN CLONES

### & the Opening of Space

#### Will the New Worlds Beyond be Braver?

by Thomas Heidel, LRS

It is the "popular (read 'Lemming') wisdom" of the day to be "horrified" at the prospect of cloning humans. There is so much disinformation - based on totally fallacious assumptions - all passed on via the path of least resistance, the gospel of "they say".

If you are one of the few who have a some open nooks and crannies in your World View, you might want to forget all you heard about "clones" and start a new file, labeled "**belated identical twins**". Such twins are a phenomenon of nature with which we are all long familiar and quite comfortable.

Consider, then, the alternative gospel of the church [small c] of "Latter Day Twins". In the so-called cloning process, another individual, sharing the exact same set of genes, is "produced". To call it a "clone" is to coin a new word when an existing word is completely and precisely appropriate: "identical twin". The hidden message in the use of a new word is a lie. "Clones" are not duplicate persons or even duplicate personalities, any more than identical twins are — and for the same reasons. Despite their identical genetic makeup, differing environments (starting in the womb!) take those same raw talents and aptitudes, temperaments and propensities, and produce differing personalities and unique self-identities. Tell an identical twin that he or she can be dismissed as a copy of his or her twin and you are likely to get a black eye — deservedly.

Much disinformation comes from hackneyed science fiction fare in which "clones" are "produced" as *instant adults*. But no known process can produce an instant adult. *The "clone" has to start off as an embryo-fetus-infant-toddler-child-adolescent etc.* with no telescoping of the generation-long time frame possible. Consider that the "clone" lags behind in birth time anywhere from moments (forced identical twin embryo produced just after original conception) to possibly years, even millennia later.

If the "cloning" takes place much later, and the resulting infant grows up in a "world" somewhat different from that of its DNA-mate, differences in personality are likely to proportionately greater. Granted, their raw talents and abilities, dispositions and temperaments, will be quite the same. But the pyramid of happenstance-tempered habits, actualized abilities, memories and learning experiences, and resulting interpersonal reactions may be quite different. The "latter day identical twin" will be *no second-class person*, but as much an individual as the "original" with his or her own "soul" and aspirations for meaning, achievement, happiness.

So the past has (a) *misdefined* "clone", and (b) *missassumed* that clones could be produced as instant adults. It has also (c) *misconcentrated* exclusively on possible misuses of clones, e.g. for the begetting of generations of "supermen" etc. to gain national or ethnic advantage and hegemony, perpetuating a self-proclaimed elite's idea of what makes an ideal person or specimen. Unfortunately, science fiction has been a medium popular with horror story tellers. That real live Nazis were obsessed with super race prospects would seem to justify our dismissal of "human cloning" without further inspection. But tell me, what sense does it make to leave to one's enemies the definition of the potential of any proposed tool? Let's say it like it is - harsh though it may seem - Clonophobes are unwitting Nazi dupes.

But the fault lies not only with those who would use such new conception techniques for ill purpose, it also lies with those timorous and intellectually lazy people who neglect to examine more reasonable and social benign roles for "belated identical twins". This essay makes no attempt to be thorough in examining positive roles for clones. My interest is that of a would-be space frontiersman.

**"How might human clones (belated identical twins) help open the space frontier?"**

Most of us got interested in space, hoping that we

could participate in the opening of the space frontier, or at least live to see the day when ordinary people with whom we could identify would routinely work and live beyond Earth orbit. But for many of us, the actual pace of events has brought with it a cruel realization that we may not personally live to see the day, much less get to personally participate.

What if we were offered the real chance to “*virtually participate*” — not via computer hookup, but *by genetic hookup*, via a belated identical twin of ourselves, someone individually distinct, but with whom we could *radically* identify? What would that chance be worth? Would it be worth a hefty investment? That’s up to you. Some, well-off enough to consider the prospect, might find the prospect very attractive. Before you scoff, consider how much parents are willing to sacrifice to give their own offspring an edge. Children are seen as our personal proxies into a future that continues after our turn on the stage has passed. How much more satisfying if our personal stand-in is a belated identical twin, with our very own talents, abilities, propensities?

Enough already! What has this to do with reality? In the short term, perhaps not much. One could arrange, with enough green grease, to have a surrogate mother bring to term a real honest to goodness “Junior”, then raise the tyke ourselves to share our aspirations for space. *It would be better* to allow the new individual to find him or her own self, even at the probably lesser risk (in comparison to any ‘natural’ offspring) that space would not be an equal priority. The idea would be that someone really and radically like you, but still him/herself, would get to do what you have apparently been born too early to experience for yourself. It is not likely that many will go through this expense, nor seriously entertain the thought!

Much further down the road, well over our sight horizons, but still within our declared aspirations, is travel or migration beyond the solar system to the stars. “Ad Astra!” is our call. While brainstorming of technologically feasible unmanned probes to or past nearby stars continues to mature, brainstorming of human interstellar travel is still the exclusive turf of science fiction writers, *or* those whose privileged inner faith allows them to ignore the laws of relativity. Quasi-religious dogmatics aside, the energies involved in sending even comatose “frozen” crews to the stars in suspended animation are so large that no foreseeable civilization will be able to manage, much less afford such missions. And to maintain “generation ships” of fully awake personnel for durations beyond their personal life expectancies would be even more prohibitive, as well as even more socially horrendous.

One alternative is to send microships with seed, spores, and frozen just-conceived embryos, and the equipment (artificial wombs, robotic nannies) to transform such a high potency cargo into plants, animals, and humans — *should a fertile world be reached*. The attractiveness of this alternative is that no lives of fully self-realized individuals will be sacrificed for the slim possibility of finding such fruitful new turf. Nor will it matter how long a noah-ark drifts through interstellar reaches before coming across a suitable nesting spot, if ever. With the new cloning technology, we need not even be talking about conceived embryos, just the DNA and

surrogate eggs needed to begin the process.

How can such an endeavor benefit from having its genetic locker filled with latter day identical twins, as opposed to a collection of random naturally produced gene sets? Via the latter, we can only hope that the brand new human population out there will produce enough people with leadership talent and other desirable qualities to give some faint hope of a successful start of a viable out-pocket of humanity. With cloning technology, however, we can select a genetic pool more likely to succeed.

No, we are not talking about a super race as usually conceived, not about people who are intellectually or physically superior by someone’s criteria. We are talking about *latter day identical twins of those who have already*

- successfully pioneered
- proven their resourcefulness and creativity
- proven their resilience, stamina, hardiness
- been successful leaders
- been constructively supportive followers

In other words, by using latter day identical twins of people whose virtues have *proven* not to be hamstrung by any tragic faults, we could optimize success. It is enough to scatter seed over an area with few hopefully fertile nooks and crannies. To further decimate the odds of success by sending ark-crews of uncertain caliber, makes such an interstellar out-settlement initiative seem even more wildly foolish. And if each ark-ship was endowed with identical unproven embryonic teams, unsuspected fatal flaws and combinations could ruin *every* attempt.

Back to our own time and place. Would some billionaire pay to add his own latter day identical twin(s) to future pioneer ship manifests? Would it be worth enough to anyone to bankroll a whole mission?

The desire for such virtual immortality might be strong enough to motivate some - it’s a highly individual thing. We all verbally prioritize space, but when it comes down to checkbook-budgeting our all too finite individual revenues, the real pie slice we give to the realization of the space frontier is often embarrassingly minor. It may never happen, but the possibility of cloning oneself, siring an identical twin to reach adulthood a generation latter, may someday loosen the purse strings of someone’s overample holdings to finance say a settlement expedition to Mars. - It’s twenty years off at best anyhow.

Cloning could also insure a supply of future von Brauns, Ehrickes, Tsiolkofskys, Forwards, etc. But natural random genetics in a gene pool as large as the present human population ensures that we will always have enough of equivalent talent - there is *no need* to hedge the bet by producing belated identical twins. The real present catch-breaker could be the personally powerful incentive to restructure one’s own financial planning. Just as individuals now “buy” a stained glass window or a pew in a new church, individuals might pay for one occupied seat on a pioneer ship, provided it be filled with someone with whom they know (not always the case with one’s natural children) they can radically identify. Even if they themselves die before departure date, they would have the comfort of knowing that their virtual alter

ego was “scheduled” for a frontier departure (we say scheduled, because, of course, in this vale of tears, nothing, nothing, can be guaranteed.)

I don’t know how many years ago, I saw a play entitled “Five Characters in Search of an Author” (the author’s name did not stick in this waxen brain). The play consisted in a number of acts in which the same set of characters started off in the same situation and ended up differently - demonstrating the uncertainties that flow from ambiguities in each of us, uncertainties that are reduced by a playwright author. In real life, experience and environment play playwright to our genetic talents and dispositions.

It will be so with “belated identical twins”. Send in the clones. Let’s fear them not. <TH>

## **Some Design Aspects of Radiation (⚡) Protection for Solar Neighborhood Fixed & Mobile Habitats :**

*Radiation Protection - as a Design Constraint*

by Richard Richardson

Two things must be considered before any design aspects of radiation protection for a crewed vessel in interplanetary space can be intelligently discussed:

- 1) What is the **radiation environment** in interplanetary space,— and
- 2) How and to what degree do the various types of radiation that will be encountered in interplanetary space affect the **physiology** of the crew?

Until the early 60's little was known of the radiation environment in interplanetary space. Since that time, however, a rather detailed analysis has been conducted. The Apollo spacecraft and unmanned craft such as the Pioneers and the Voyagers as well as many others have spent extensive mission time in interplanetary space. Many of these craft were equipped with the appropriate sensors to allow scientists to determine the radiation environment of interplanetary space with considerable accuracy. Over the last eighty years or so, and especially since the creation of the atomic bomb and atomic fueled electrical power generators a great deal has been learned about the physiological effects of the various types of radiation.

The **kinds of radiation** that will be of concern to interplanetary travelers are:

- very high energy electromagnetic waves
- very high energy light nuclei (protons)
- high energy heavy primaries (atomic nuclei which are heavier than single protons)
- bremsstrahlung effect radiation (which is the radiation emitted when a physical object is struck by high energy radiation).

Radiation damages cells in two ways: physical disruption and chemical disruption.

Physical disruption is the bullet effect whereby kinetic energy is transferred to the atoms of the cells at an impact site causing the shattering of the cell or cells involved.

Chemical disruption is the result of the atoms at and near the impact site becoming ionized and forming chemical bonds which impede or destroy the functioning of the chemical machinery of the cell or cells involved. This damage can spread over a several cell width due to secondary kinetic and/or ionization transfer as well as due to bremsstrahlung effect in the tissue itself.

It has been found that the **background radiation level** in interplanetary space (cosmic radiation) is at a level of about 10 rad per year. Although this is about 20 times the U.S. allowable rate for workers in certain fields with some risk of ionizing radiation exposure and about ten times the rate that an airline flight attendant might receive, it is, nonetheless, a level which probably would pose little danger over extended periods of time.

However, the small percentage of cosmic rays that are heavy primaries do pose a serious risk even over a period of time as short as months, or perhaps weeks. In addition, solar flares can and do fill inter-planetary space with hundreds or thousands of times the radiation of the background level on a very unpredictable basis. As a result, for a mission of more than a few hours to be reasonably safe there is no escaping the need for some sort of radiation shielding.

It is important to bear in mind that placing physical material in a radiation environment like that of interplanetary space will result in the creation of **bremsstrahlung effect radiation**. This generates much more harmful radiation. However, the bremsstrahlung effect radiation is caused by the spreading out of the original particle's energy over many particles. Each of these secondary particles will also spread their energy out over many other particles (if there are other particles for them to collide with in the direction they are going). And on, and on, and on. This chain reaction will come to a halt when the energies of the individual particles fall below the threshold necessary to disturb additional particles.

Therefore, a sufficiently thick shield will protect against most or all secondary radiation effects. Combined primary and secondary radiation effects are reduced to a level of about 0.5 REM per year by a radiation shield composed of **regolith** type material which is about two meters thick or a **water** shield of about five meters thickness. Less shielding and greater radiation exposure might be acceptable to a certain degree. But, in general, the less radiation exposure the better.

It is also conceivable that a **force field** of some sort could be used rather than, or in addition to a physical radiation barrier. However, the technology for such a force field is not presently developed to a point where this would be a viable option.

### **Radiation shields for vehicles**

Because we are discussing shielding for a transportation device it is necessary to consider the implications of the radiation shield as an **inertial mass**. The greater the total mass

of the spacecraft, including its radiation protection system, the greater will be the energy (and hence the fuel) required to operate it as it speeds up, slows down, and changes direction to move from one place to another. Therefore, from this perspective, the less shielding mass the better.

One possible way to try to minimize vehicle mass and still maintain the necessary degree of shielding might be to develop **integrated spacecraft designs** which rely on other vehicle components doing **double duty** as radiation shielding. Some such components are engines (though if they are nuclear engines the crew might need to be shielded from engine radiation as well), aerobrake shields, fuels, or cargo. <RRR>

### BIBLIOGRAPHY

O'Neill, Gerard K., **The High Frontier**, Space Studies Institute Press, 1989, pp. 103-108

Savage, Marshall T., **The Millennial Project**, Emyrean Publishing Ltd., 1992, pp. 138-145 and pp. 410-414

[Richard Richardson is founder and president of the Deschuttus Space Frontier Society [formerly the Central Oregon Space Society] in Bend, Oregon, home of the Oregon Moonbase. He has built a dome house in Bend, but also spends much time in Deering, Alaska, near Nome - a true frontiersman. Through the years, Richard has contributed several articles to MMM.]

## MMM #105 - MAY 1997

### *Enter Europa and the Return of a Three Planet Future*

Once upon a time, the unquestioned popular vision of human destiny in space offered three principal venues: the Moon, Mars, and Venus. Back in the early sixties, when, in advance of probe confirmation, radar imaging of Venus revealed a sulfurous hell hole, not some steaming supertropical rain forest island-dotted global ocean, we lost a world.

After decades of a Moon-Mars litany, it is ever more clear that Europa will play an exciting role on our space horizons.



### IN FOCUS

### *The "Man in the Mirror" Strategy for Opening Space*

by Peter Kokh

When it comes to popular music, melody and rhythm catch my attention much more readily than do lyrics. But one relatively recent number whose words really did catch my

attention was Michael Jackson's "Man in the Mirror". The message is prime cosmic insight. "The man in the mirror", of course, is the one looking - you - yourself. The one real lever you have to affect the World's unfolding is yourself. Change yourself, and you begin to change the World. We must each start with "the man in the mirror".

Development and cultivation of one's talents and aptitudes is everything. These are the raw tools we are born with, and most of us under-develop at least some of them. It is through these very personal tools that we can most effectively affect the world around us. Our excuses? *Not enough free time* (but we have only one life to live and every moment spent not being up to par is a moment whose potential we waste; *not enough money* (but more often than not, by neglecting talents or their development, we suppress our full income potential).

We have always rejected the "party line" that the space activist is the one who is involved politically in the promotion of the government public space program. That is a drum to whose beat not all of us are comfortable marching.

The true space activist is *any person who* strives to effectively use whatever mix of talents and aptitudes he or she has to promote the earliest realization of an open space frontier. Each of us works most effectively doing what comes naturally, working with the grain of who we are, according to our talents and aptitudes. Forced or cajoled into another mold by others, we can scarcely do our best. Don't ever let anyone reduce you to such a common denominator (phone dialer, letter writer, wallet opener). You may have much more to give than that.

Individually, we need to prioritize those hobbies, and/or types of income earning activities which exercise our talents — over those activities which contribute nothing to personal development but only serve to pay bills. Doing so, may come at least temporary cost, reduced earnings. But the rewards of self-fulfillment, and our effectiveness in interfacing with the world at large are a priceless perk. Again, we only live once.

For some of us, a rededication to developing our talents and aptitudes may affect only the way we budget our spare time, that is, our hobby activities. For others, a more difficult eventual occupation or career change may be in order. The sooner we start, whatever our age, the better, the more we have to gain and contribute by changing the man in the mirror. If you think making such changes in how you use your time and energies is difficult, consider how much more difficult it will be to change the world, without so changing yourself first!

Take stock. What do you 'know how' to do fairly well? What things have you always felt you might have it in you to do, but never got around to pursuing (you got waylaid by life and family and job and their demands first)? What abilities have you let atrophy? Not sure? Take a professional aptitude test. Ask to see results of tests you have taken already at school or work. Identify areas that have not received enough attention. Make a practical plan to do something about at least one of them. A start! Talent development, is a life long process. We need the *habit* of self-improvement. We can't get up to talent-par by some facile abracadabra. It takes time, patience, determination, and overcoming many setbacks.

Time management will make or break your project. Look at your day (work, home), your week, your month. Be



frankly honest in writing down all the ways you (find to) waste time - we all waste time, but the list of ways we do it differs for each of us. This is time that could be given to talent/aptitude improvement. We only live once. Inertia is the enemy.

You may have to *demand* sanctuary both in terms of physical space and hours on the clock for self-development. This does not cheat your family. Indeed, not to do so in the long run down-the-road cheats your family more. You will be the best you can be for them, only if you take care to become the best you can be in yourself. It's a matter of patience, on your part, and on the part of those with whom you share your life. They *owe* you that. Insist on it!

Just as not everyone in the army carries a rifle, "the army for space" will be its strongest, when each of its very individual soldiers has taken every effort to see that he or she "be all that we can be". False generals would reduce us all to trigger pullers!

The realization of mankind's future in space proceeds on many tracks in as multiversal a fashion as has the development of "World One" since time began. All of history's legislators, leaders, and politicians would have gotten us nowhere without countless unsung farmers, scientists, educators, artists, craftsmen, tradesmen, entertainers, writers, poets, and others, even lawyers. Many less direct, less prestigious, less obvious roles and contributions to the the breakout from Cradle Earth are waiting to be made. There is a role that is unique to you and your own identity, one that will build your identity further. Start with "the man in the mirror".

<PK>



## **Windows, Sundows & Other Products for Space Frontier Vehicles & Habitats**

*A Call for Active Investigation and Research*

by Peter Kokh

Aerogel is the lightest known solid, literally foamed glass, though it can be made of other raw materials than Silica (Silicon Dioxide, common beach sand, the major component of both glass and quartz), such as Iron Oxide. First developed decades ago, we have begun to see new space age applications and refinements with exiting implications.

Aerogel is translucent, but until a recent manufacturing experiment in space, not quite transparent. Previous samples have had a somewhat blurring bluish cast caused by the uncontrollable inclusion of a certain percentage of larger "bubbles" in the froth. Bubble size has now been successfully controlled in micro-gravity, resulting in a product that not only transmits light, but views.

Its density is much less than a batt of fluffed fiberglass, giving it the added attraction of being a storybook insulator. On the other hand, it is quite porous, and could not be used, alone, to contain atmospheric pressure, against a vacuum, for example.

Given this information, what uses can we see for this remarkable material on the space frontier? We will try to give a

glimpse of some of the possibilities. But bear in mind that the writer has not been able to find all of the information he considers relevant to such a forecast. Perhaps you can help, and we invite informed reader feedback. Specifically, we have no idea of what kind of mechanical strength the stuff has. Conservatively, we are assuming that it is very weak, that it can be broken, punched through, and snaps when bending pressure is applied.

### **Aerogel Windows?**

The space-made stuff suggests itself as window panes. Maybe on Earth, where pressure differentials are seldom more than a tenth of 1 ATM. But, superior insulating value or not (equivalent of a 5-pack of twin glass thermopanes), there will be little market for it if we can only make it in microgravity. It would be prohibitively expensive.

For space use windows, it would apparently have to be sandwiched between two panes of normal glass. Could they be laminated? Would the glass-aerogel-glass sandwich be lighter in weight than an all glass pressure window? Would mylar be enough? If so, there would be a market for such windows if ever we start co-manufacturing space stations and vehicles in space itself, for use as in-space ferries, or in amphibious craft that will work as well as lunar or Martian surface vehicles. We have a potential future market, but that's a lot of ifs.

Windows for lunar and Martian habitats? In both cases we have adequate supplies of suitable local raw materials. But the same reservations we brought up for aerogel windows on Earth will apply out there. Can we learn to make the stuff transparent in fractional gravity (1/6th, 3/8ths respectively)? Maybe, maybe not, more likely so on the Moon than on Mars. If not, and transparent clarity is what we require, such aerogel panes (e.g. made from Lunar Silica in low lunar orbit) would be an expensive option, though perhaps less so than on Earth with its much deeper gravity well up which to bring the raw materials to be transformed. However, if what we want is light, more so than the view, or if we can tolerate a blue haze, we may well see some made-on-Luna aerogel sandwich windows. Might a selling point be superior protection against micrometeorite caused decompression accidents (insofar as, if laminated, the aerogel fill would tend to keep the window from shattering altogether)? A hole in aerogel should be minimal and neat.

### **Aerogel Thermal Insulation?**

Let's look at uses of aerogel that do not hinge on its transparency. Insulation is certainly one of them. As the boxed material on page 5 indicates, aerogel has already been used to insulate the Mars Pathfinder rover, Sojourner. It is not obvious that aerogel (R20/inch!) would be a superior insulating material for lunar and Martian habitats. The lunar regolith (we can only speculate on the heat transmission abilities of various types of Martian soils) is a sufficiently poor conductor of heat that the addition of aerogel batts in habitat exterior walls probably would not be cost-effective. However in unshielded construction shacks, camps, and in surface vehicles, its superior insulating value combined with ultra light weight would make it the unquestioned top choice. But aerogel does not do everything regolith shielding does - it offers no real

protection against radiation. Its use as a thermal insulator will likely be limited to the instances suggested above.

### **Aerogel as Acoustic Insulation?**

Aerogel, we assume, is a superior acoustic insulator as well. In limited volume space settlement and lunar and Martian subsurface communities, reverberating sound could be a very nasty problem. Much attention will be given by habitat and town architects to sound deadening surfaces, sound baffling, and sound insulation. Aerogel could play a major role in making any such settlement livable.

Aerogel, given its minimum weight penalty, could be standard packing in interior space vehicle walls to control on board noise transmission. Any one who is spent time aboard a ship (or a submarine!) knows how important that could be.

## ***Aerogel: Energy-Efficient Material for Buildings***

from <http://eande.lbl.gov/CBS/NEWSLETTER/NL8/Aerogel.html>

Aerogel has exceptional insulating properties — *an ounce of it has the surface area of 10 football fields*. This is only one of its interesting properties. Aerogel's potential applications include:

- energy-efficient insulation and windows
- acoustic insulation
- gas-phase catalysis
- battery technology
- microelectronics.

The Microstructure Materials Group of LBNL's Energy Conversion and Storage Program has been studying the basic properties of aerogel and the techniques to refine desirable qualities like transparency and insulating efficiency. Another goal is to make its manufacture safer and less expensive.

As the name implies, aerogel is mostly air, the lightest existing solid material with a surface area as high as 1,000 m<sup>2</sup> per gram. It is one of the few existing materials that is both *transparent* and *porous* and can be *formed into almost any useful shape* and makes an excellent insulator. Although silica aerogel is the most familiar form, *metal oxides such as iron and tin oxide, organic polymers, natural gels, and carbon* can all form aerogels.

Discovered over 60 years ago, aerogels are being developed in the Microstructure Materials Group with an eye to commercial application. Steven Kistler, at what is now the University of the Pacific, in Stockton, California, first experimented with aerogels in the '30s. He proved experimentally that the more familiar liquid-based gels or jellies were an open solid network of cells permeated by liquid. Kistler made the first aerogel by soaking a water-based gel in alcohol to replace the water. He heated the alcohol and gel in a closed container to a high temperature and pressure (80 ATM, 240°C), slowly depressurizing the vessel, allowing the alcohol vapor to escape, leaving *an air-filled cellular matrix*.

Today, researchers typically prepare *metal oxide aerogels* by reacting metal alkoxide with water to form an alcosol, a suspension of metal oxide particles in alcohol that link together to form an alcogel (alcohol-permeated gel). The alcogel is then dried at high temperature and pressure to produce aerogel.

The MMG developed a process for producing aerogel at lower temperature and pressure by substituting *liquid carbon dioxide* for the alcohol in the gel under pressure, then drying the aerogel with carbon dioxide at 40°C and 70 ATM considerably reducing the risk of explosion and fire compared to the high-pressure alcohol process. The new method also decreases the energy use and manufacturing time thereby lowering the costs.

Aerogel's primary building-related application is as a transparent or high-performance thermal insulator. An obvious choice for super-insulating *windows, skylights, solar collector covers, and specialty windows*, aerogels are transparent because their microstructure is small (average pore size 10-20 nanometers) compared to the wavelength of light (400-700 nm). *Their slightly hazy blue appearance is a deviation from transparency that is caused by the occasional appearance of large pores*, a happenstance revealed by Microstructure Materials Group's light scattering and transmission electron microscope studies. Current research to improve clarity is focused on decreasing the number of larger pores.

Arlon Hunt studies a sample using a light scattering instrument. Aerogels are efficient thermal insulators as well. *Silica aerogel has a higher thermal resistance than the polyurethane foams* that are widely used in refrigerators, boilers and building insulation. Since these foams are blown with ozone-depleting CFCs, aerogels could be an excellent CFC-free alternative. *Aerogels in a partial vacuum are even better insulators*, because removing most of the air from their pores eliminates half to two-thirds of the material's thermal conductivity (portion due to gas conduction). *Silica aerogel in a 90% vacuum*, is simply and inexpensively produced, and has a thermal resistance of R-20/in. *A one-inch-thick aerogel window has the same thermal resistance as a window with ten double panes of glass*. Researchers have improved their performance to R-32/inch by adding carbon, to absorb infrared radiation in the panes, another mechanism of heat transfer. Carbon-doped aerogels are perfect candidates for opaque insulators e.g. those used in refrigerators and pipes.

Current LBNL research is focused on development of new nanocomposite materials based on chemical vapor infiltration and reaction of gases in the aerogel. Resulting materials may have a wide range of applications in electronics, optics, and sensors. A cooperative research and development agreement with Aerojet Corp. will transfer the production methods into the commercial sector and refine the current aerogel process for large-scale production.

The group is also working with Maytag on refrigerator insulation application, with General Motors and Bentley on automotive insulation, and with Boeing on acoustic and thermal insulation.

Arlon Hunt and Allan Chen  
Energy Conversion and Storage Program  
(510) 486-5370; fax (510) 486-4260  
AJHunt@lbl.gov

This work is supported by DOE's Office of Industrial Technologies and the Advanced Research Project Agency's Technology Reinvestment Project.

## Other Aerogel Building Products?

*Wild imagineering by the Editor*

Here are some of the possible lunar building products that could be made with aerogel. *Readers are welcome to look for show stoppers in each suggestion as well as to suggest other uses.*

- UV-proof aerogel sandwich windows in on-surface unshielded “sun-rooms” in which Lunans could go to soak up the “sun” for periods tightly limited to control concomitant radiation exposure.
- Skylights in ramada canopies, minimally shielded structures under which routine out-vac surface activities could be performed in the “lee” vacuum they provide by workers wearing lighter weight pressure suits. [MMM # 37 JUL '90, p 3, “Ramadas”]
- Hydrosshield domes, solararia, atria - in which translucent water is used as shielding (one of the striking suggestions of Marshall Savage in his “The Millennial Project”)
- Water-filled “sundowns” in habitat ceilings along the same principle. In both, aerogel would act as a transparent thermal insulator.
- Sun-exposed banks of clerestory window in otherwise normally shielded (cylindrical) pressurized settlement streets
- Lamp shade and lighttube sunport diffusers
- backlight diffusers
- translucent walls & dividers
- interior clerestories

### Opaque formulations could include:

- Lamp shades
- drop ceiling panels
- exterior shade walls

If the stuff has, or can be given real structural mechanical strength, how about these uses:

- Floor underlayment
- light regolith shielding pans in a ramada canopy
- a sort of lightweight “dry wall” panel

Even if aerogel must be laminated to a much stronger structural material, it may find application as the inside surface layer of choice for built-on-the-Moon habitat structures made of local materials because it is much more water-resistant than glass (and by extension, than glass-glass composites, a top candidate material for making lunar habitat hulls). For the same reason, it could be used to line limited pressurized lavatube volumes, the walls previously laser or microwave fused to be air tight.

**Question:** *how well does aerogel transmit red light, essential for plants?*

**Question:** *is aerogel “paintable”?*

We must learn more, but the prospects for aerogel on the space frontier seem bright. <MMM>

# Burial off Planet

by Peter Kokh

## From Star Ashes to Star Ashes: Disposing Remains in Orbit

With the orbiting of the Celestis capsule, via a Pegasus launcher, carrying the cremated remains of twenty-some people, it would seem that an historic threshold has been crossed. However, the orbit is too low and the remains will be “in space” for only about a year before a “fiery reentry.” What we have is only a gesture, an overture. The day is yet to come when the first human born of Earth-clay will be laid to rest in whole or in ashes, truly off planet.

Yet the Celestis mission fails only because the sole affordable launcher wasn't powerful enough. Psychological and legal barriers will have indeed been dismissed and the gates to heavenly disposal are now clearly open.

Where are more appropriate sites located? To be above the point where orbital decay induced by drag from high atmospheric traces will inevitably win out, any “orbiting cemetery” should be at least 450 miles or 700 kilometers above the surface, not that difficult a destination. “Higher LEO” may soon be a popular resting place for a growing number of the cosmically-conscious well-heeled.

If the Russians want to get into this moneymaking act, their Molniya launchers and Molniya orbits might quickly become much more popular, both with those anticipating internment in space and with the beloved whom they leave behind on Earth. Molniya orbits are very eccentric and can be launch-determined so that their low points (perigee) at which the internment capsule is traveling very fast (both actually, and through the overhead sky) is over the part of the world opposite their homeland, while the high point (apogee) at which it is traveling very slow (both actually, and through the overhead sky) lies over their homeland for a major portion of each day, noon to midnight, for example.

Internment in GEO, or geosynchronous orbit, would be both more expensive and much more difficult to arrange, as GEO slots are already too limited and need to be reserved for communications etc. More expensive yet, at least at this juncture, would be internment in the L4 or L5 Lagrangian Sargasso-like dust seas. These areas, long popular with Space Settlement enthusiasts (e.g. the L5 Society) center some 240,000 miles out in the Moon's orbit, respectively 60° ahead and 60° behind the Moon's position, keeping approximate formation.

Another possibility is internment in “solar” orbit, beyond the shoulders of the gravitational well of the Earth-moon system. This will appeal to those who see mankind expanding to fill “all the space under the Sun”. Next in expensiveness would be capsules on solar “escape trajectories”, following Pioneers 10 and 11, and Vikings 1 and 2 out of the system altogether, forever to drift *among* the stars *at random*. “Ad Astra”, it will hype on the brochure. “To the Stars, your personal dream can come true!”

Not only will residents of Earth be buried in such orbits, a few future residents of the Moon, Mars, and other surface locations may also choose such arrangements. But, as

opposed to visitors, those who have come to settle, or who have actually been born there, will predictably strongly prefer burial of some form on their adopted home worlds.

So far, we have been talking only about disposition of ashes, which weigh far less and are much more compact than whole bodies. The fuel and transport bill for intact burial in space could be as much as a hundred times higher. However, it goes without saying that many who actually die *in* space, stationed there or in transit, will simply be set adrift out the airlock with appropriate ceremony, Navy (and Star Trek) style. Their fares into space have already been paid, and this disposition will be an incrementally inexpensive option.

**On Other Shores**

But, beyond settlers and others stationed beyond Earth, will people who have lived all their lives on Earth and never been beyond orbit choose disposition of their remains on the Moon and Mars or other planetary surfaces? Certainly, as soon as the option becomes affordable and feasible. Crash-landing of Celestis-like capsules on the Moon is certainly not technically or financially difficult, but neither may it be seen as desirable. But soft-landing on-surface disposition of such capsules should not be that much further down the road. For myself, if I had the bucks to choose, I'd want my ashes strewn on some Luna City memorial flower bed — that presumes an outpost, still over the horizon. [MMM # 47, JUL '91, p. 6 "Funerals Befitting Future Space Pioneers"]

**More than ashes?**

While cremation has long since shed its 'anti-resurrection' stigma, there are surely some who would prefer to keep their bodies more intact and yet would like to be interred in space - somehow. Making such an option affordable would seem to demand some way to reduce the body's net weight. A few years ago, an entrepreneurial Minneapolis outfit offered to "freeze dry" departed pets "in whatever favorite posture" the customer would like. We have heard no more since of this enterprise, and assume that at nearly a thousand bucks a shot, there was insufficient business to provide cash flow. However, apparently the technological hurdle from freeze drying banana chips to whole pet bodies has been successfully mounted. (We could find nothing on this via the web search engine we used).

Nature has led the way, of course, preserving the remains of birds and seals in mummified freeze-dried state in the Antarctic. We have suggested before the ready-to-seize entrepreneurial opportunity of offering the option of internment under glass (to keep out flesh-blackening ultraviolet rays) and under a heavy "hardware cloth" mesh screen (to keep out scavenging Skua birds) in one of the Antarctic "Dry Valleys" like Wright or Taylor, where one could lie out in the open, naturally preserved face-up under the stars. We have dubbed such a future resting place a "dessicatorium", and suggested it as a preview of above surface internment on the Moon and Mars (atop Olympus Mons, for example).

Dessicatoria in orbit? More expensive than Celestis to be sure. But why not. Bodies could be cordwood stacked, staggered on a bias under a glass hull, so that they each faced Earth, or the stars, in whatever grav-stabilized orientation they preferred.

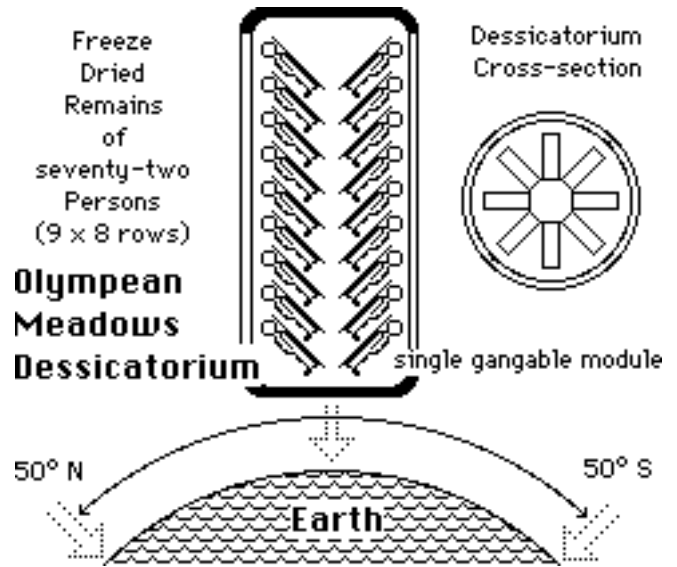

**The Canopic Option - Less Expensive Yet**

Animal and human bodies are approximately 70% water by composition. So freeze drying would make the proposition of "intact" burial off planet that much more affordable. Taking a page from the ancient Egyptians, we can improve on this further. What we want to preserve intact is the visible body. We can eviscerate it first, cremating the internal organs (with brain) and placing the ashes inside the body shell in a small capsule called a Canopic Jar.

To compare, the all-ash "Columbarium" keeps some 3% of the original live body weight. The freeze-dry "Dessicatorium" preserves about 30%. Canopic Dessicatoria (organs to ashes) would keep about 15%

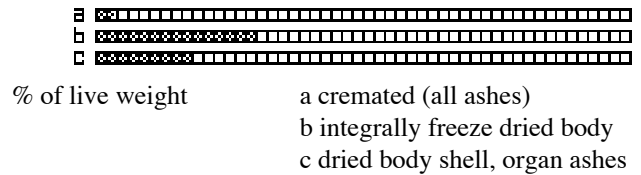

**Visitation?**

Next, of course, will be enterprises providing internet site visitation by the bereaved! <MMM>

**The Basics Of Freeze Drying**  
 from <http://www.virtis.com/basics.html>

Freeze Drying or Lyophilization: a process of stabilizing initially wet materials (aqueous solutions or suspensions) by freezing them, then subliming the ice while simultaneously desorbing some of the bound moisture. Following removal of the ice, desorption is prolonged under vacuum.

- Desorption: The release of liquids and gas trapped within a substance.
- Sublimation: Vaporization or evaporation wholly from a solid phase without melting.
- Primary Drying: involves sublimation of ice, with concurrent desorption of bound moisture.
- Secondary Drying: Prolonged drying stage for desorption until desired product consistency.

To preserve a product without altering it, there is no replacement for freeze-drying. This *gentle process* removes moisture from aqueous product, *without affecting its biological, chemical or structural properties*. A rigid ice matrix holds the solid components in place, maintaining item integrity. Conventional drying typically causes shrinkage or chemical reactions, damaging cells, rendering the item useless for final display.

The process has three basic process steps:

**1. Freezing** - In the first step, the product is frozen solid. The final temperature must be below the product's eutectic, or collapse temperature, so that it maintains its structural soundness. Then the condenser and vacuum systems are energized for the next critical process step.

**2. Primary Drying** - In the second step, the unbound water, as free ice, is removed by converting it directly from a solid to a vapor, by sublimation, under vacuum, to ensure that the pressure of the water vapor remains below its "triple point", as required for sublimation to occur.

**3. Secondary Drying** — After all the free ice is sublimated, there may still be enough bound water to limit the body's structural integrity and "shelf life". During secondary drying, the sorbed water that was bound strongly to the solids in the product, is converted to vapor. This can be a slow process; the remaining bound water has a lower pressure than free liquid at the same temperature, making it difficult to remove. Secondary drying starts during the primary phase, but must be extended after the total removal of the free ice to achieve low enough residual moisture levels.

Freeze-drying is complete when all free and bound water is removed, resulting in a residual moisture level guaranteeing the desired biological and structural characteristics of the final product in a state that can be preserved indefinitely.

**Gay Steven**, <Steven.Gay@medecine.unig.ch>  
Med MD/PhD student, Dept. of Physiology  
University Medical Center of Geneva, Switzerland

[EDITOR'S RESPONSE: I do not know how serious an obstacle glycol would be. There ARE terrestrial organisms which incorporate into their protoplasm, and obviously it is not toxic to them. If they are toxic to others when eaten, are they then excluded from the local food chains? Perhaps. I don't mean to be facetious, but some kinds of sushi or raw fish are rather toxic but people, at least some people, have learned to eat them in "spice" proportions that add no more than serious 'bite' to the meal.

A much more important question to be asked is if glycol is transformed into another less 'toxic' or altogether non-toxic molecule or combination of molecules upon proper heating, i.e. cooking?

MMM's purpose has never been to come up with all the answers, as if this could be done without homework. We are NOT equipped to do that home-work. It is rather our hope that someone reading what we write, and better prepared and equipped to find the answers, will be stimulated to do the research or further brainstorming required.

If we had to have 'certainty' about everything we wrote, we would write nothing. By the same token, those afraid of failure or making mistakes, end up doing nothing. We would be delighted to be found way off track, *if* the 'preposterous' thing we proposed inspires someone else to find the truth. If someone can leverage our ignorance to make real progress, why then we have served some real purpose.

I thank you for your letter, and encourage you to brainstorm alternative approaches. — Ed.]

## MMM #106 - JUN 1997



### E- **Breeding "Mars-hardy" Plants**

4/9/97 My comment is on the [web archive] article 'Breeding Plants for Mars Environment' [MMM #93, March '96, "REDHOUSING: Breeding 'Mars Hardy' Plants in Compressed Mars Air" pp. 5-7] where you propose to genetically build plants containing glycol to prevent if possible freezing.

The idea is good but what troubles me is that glycol is a toxic (cf. <http://www.njnet.com/~embbs/cr/alc/alc7.html>). Wouldn't it be better if a plant dedicated to growth on an entire planet could be also food (for humans or animals)?

I didn't check the freezing point of other alcohols, ethanol for example, but there may be a less toxic product than glycol.

There is also the point that even if we send a slow growing lichen-like plant at the time it has colonized all of Mars we could face 'some' difficulties to destroy (if we need) this uneatable weed.



### *The Rocky Road on the way to Cheap Access*

We may have cheered too early when bids were let out for the X-33, too early when Lockheed Martin's technology-pioneering "Skunk Works" VentureStar proposal was picked. A lot of things threaten to vitiate the process and produce a vehicle - even that is not sure - which, as the Space Shuttle before it, hardly fills its design goals.

## IN FOCUS

### **Failures are the Stuff out of Which Success is Made**

At the LRS chapter meeting in Milwaukee this month (May), we were discussing various plans for ISDC '98 which will be held at the Hyatt Regency Milwaukee next spring. One of the special things the committee wants to do is a "poster session" entitled "Space Entrepreneurs Hall of Fame". Groups

and individuals will be invited to “nominate” individuals they feel have contributed to (or to the prospects for) the commercialization of space. Some nominees are obvious, like Arthur C. Clarke, with his prediction of communications satellites. The nominating group or individual will prepare a story board and short paper about the nominee (criteria and format under discussion) as an entry in ISDC 98’s “SEHOF”. We’d want the display items to be sufficiently durable so that SEHOF\* could be a traveling, and growing exhibit available to future ISDC’s.

[\* Because of disagreement in the ISDC 1998 Committee over criteria, this Exhibit was never put together.]

During the discussion, one chapter member objected that there *are* no space entrepreneurs *yet*, especially if you add the qualifier “profit-making”. “So far,” he said, “there have only been grandiose plans and lots of failures.” We think that’s a very narrow view, and also implies an unnecessarily restricted view of what kind of enterprise can be called “space related”. Be that as it may, a more important point has been brought up: the tendency to devalue and dismiss failure.

Someone (I do not recall who) has said, aptly, “show me the man who has never failed, and I’ll show you a man who has never tried.” Many persons in fact justify “not trying” by fear of failure. Indeed, in any envelop-expanding ground-breaking effort, the probabilities of failure are demonstrably greater than those of success. This has not stopped the scientific process nor the inventive tinkering which has led to the tremendous, ever quickening, and ongoing crescendo of technological culture tracing back to the discover of sticks, stones, and fire.

When someone succeeds brilliantly, he or she might make a gesture of humility by pointing to the “shoulders of others” on which he or she stood. But it is not only the wave crest of past successes we ride, it is also the much deeper tide of past failures. For failures help define the limits of the possible, whether technological, financial, cultural, or political — and by doing so, reduce the odds of success against the next brave spirit to rise to the challenge. Past failures help define and illuminate the route that eventually leads to success. Because of this humble but vital service performed by all those who try but fail, no one should be ashamed of having not achieved a “goal”. It may take some humility, but in that case, it *is* the humble who enable final glory.

This is so not only of those who invent new doodads or processes, but also of those who “brainstorm” in general. Attempting “to creatively foresee” future pathways is just as risky an endeavor as attempting to pioneer them. But *if* one’s error, *however* wide of the mark, is the *triggering occasion* of another’s finding a better way, then the service of that error is a happy one. As the Christian liturgy says of Adam’s “sin”, “Oh happy fault” (because it created the need for a savior and redemption).

Thus in western culture there is a long tradition of recognizing the service of those who have failed and yet contributed all the same — often precisely because they have failed, or because of how they have done so. That we classify our bunglings as “learning experiences” testifies, in self-deprecating humor, to this positive value. To succeed *means* to have *risked* failure and won.

In his classic “*The Moon is a Harsh Mistress*”, Robert A. Heinlein coined the epithet “*tanstaaf!*”, actually an acronym of “**There Ain’t No Such Thing As A Free Lunch.**” Tanstaaf! applies to success as to anything else that is desirable. In the end, we have to pay for it. And the coin is not only hard work and careful research and preparation and talent honing etc. The coin is frequently prior failures.

Putting in place the various paving blocks of the road to space is no different from any other endeavor. But in that the task is very complex, inter-involved, and largely beyond currently pedestrian technology, we can expect the failure to success ratio to be higher than most other avenues of endeavor.

Elements required have to be tackled in the order of “prerequisites” - they have to be terraced. We can’t expect to create an all new space-based solar power satellite energy system before we have enhanced present energy systems with power relay satellites, creating a world energy grid. And so on.

Getting us into space, commercially, is a cat-livered pursuit - many failures already to our credit as dues paid. Otrag, Amrock, Connestoga, the list goes on and on. But with each failure we learn and success becomes that much less improbable for those with enough optimism to pick up the pieces and follow.

Organizations too, have had a moment in the Sun, only to “fail”: L5 (which has an afterlife of sorts in NSS), LDC (Lunar Development Council), LBO (Lady Base One), etc. This record must not discourage us.

That we persist, we who would have the stars, despite all these battle failures, is testimony to our credentials - we have the right stuff. We know how to turn failure into success. *We will win the war.* <PK>

## ***The Real Question About Life on Mars***

by Tihamer Toth-Fejel <tff@rc.net>

The scientific and aerospace communities, along with newspapers all over the country, have made a big deal out of the recently discovered evidence for life on Mars.

Dr. Hugh Ross predicted five years ago that such a discovery was inevitable because of the meteoric debris that floats between planets. Robert Zubrin, Chairman of the National Space Society, has pointed out that Martian rocks have been landing on Earth at a rate of about 500 kilograms a year, and that Martian bacterial spores could have survived the trip. The reverse trip is also possible for over a hundred Terran bacteria, so why the big fuss?

We should send more probes to Mars to determine the issue completely, but I predict that any life we find will have DNA that looks terrestrial. This would only prove that we humans are not the only space-traveling species in this solar system, and that life is a bit tougher than we thought. Of course, such a discovery wouldn’t solve the issue of where life really started: Earth, Mars, both independently in parallel paths of biochemical evolution, or some other common source, such as interstellar Space.

What bothers me is that an enormous unasked question underlies all this hoopla, and nobody in the popular or

academic press is asking it, although physicist Enrico Fermi raised it almost a generation ago. He pointed out that at our current pace of technological growth, humans will soon be building starships and visiting neighboring stars.

Like the American explorers, some of them will settle where they land, while others (or their children) will move on to the next star for elbow room, religious freedom, or new opportunities. A conservative estimate of this process predicts that humans or their self-replicating robots will explore, settle, and develop every planet around every star in our Milky Way within 250,000 years, a mere cosmic eyeblink in the lifetime of the Universe.

We live on an ordinary planet that orbits an ordinary sun at the edge of an ordinary galaxy. Our "averageness" makes it extremely unlikely that we are the first intelligent species to leave our planet. Our best scientific estimates show that our galaxy contains up to a billion stars that could have developed intelligent life -- so at least half should have done it before us. Now it is conceivable that many of these alien species live on water worlds (and therefore never discovered fire), or blew themselves up in nuclear wars (because their technological power outstripped their moral character), or preferred poetry to engineering (inadvertently leading to their extinction when the next big meteor hit), so they never built their first starship.

But why has *none* of these possible aliens done what life has *always* done - expand into *every* niche available to it? And why have they left no trace of their existence?

An advanced civilization could leave at least three traces:

First, radio: Every viewer with a standard radio telescope within 35 light-years can watch "I Love Lucy", and Earth would be the brightest radio source in the sky. In fact, an Aricebo-sized radio telescope could pick it up from across our galaxy. But SETI has found no trace of anything.

Second, starship tracks: Physical objects traveling at significant fractions of lightspeed leave trails of Cerenkov radiation that would crisscross the sky for our detectors.

Third, Dyson Spheres: Surrounding a star with an enormous sphere would essentially turn an entire solar system into a giant space ship, and would multiply the living area and/or standard of living by a factor of a billion. Such a macro-engineered structure would block the visible light of a sun from our sight, but it would radiate heat as inferred light.

But physical presence and planetary development would be the most obvious. Everything we know predicts that aliens should have been here a long time ago, and they should have developed our planet out from under us. Out of a billion species that could have gotten here, there are many reasons that would keep many of them away. But there is no reason that adequately explains why *none* of them are here. That fact indicates that there is a gaping hole in our knowledge about the universe, and our place in it.

As Sherlock Holmes said, when the obvious is ruled out, then only the alternatives, no matter how fantastic, *must* be considered.

Are we in a cosmic wildlife preserve? Then where are the tourists and the poachers? Is Earth under some sort of

universal interdict by an organization whose border guards cannot be tempted, reprogrammed, or overpowered? Is the emergence of intelligence an automatic death sentence to a biosphere because of the technological power it gives for self-destruction? Or does advanced technology mean that the race "moves on" into a Singularity? Do automated war machines from forgotten interplanetary wars roam between the stars? Does the Anthropic Principle, which shows that we are in a unique epoch since the Big Bang, predict that we must choose the final destiny of the Universe? Is our concept of "little green men in flying saucers from Alpha Centauri" adequate? Are our preconceptions of angels and demons too limited?

As we move off this planet to insure the survival of our biosphere, I'm scared of hard vacuum, meteorites, and fatal radiation, and I'm really scared of the dangers we don't even know about.

But what scares me the most today is that scientists and the media are refusing to address the real implications of life on Mars. By ignoring an enormous paradox in our knowledge, we will remain ignorant -- and our ignorance may be fatal. <TTF>

[Tihamer Toth-Fejel <ttf@rc.net> (trouble with a capitol "Tee") is a cofounder of the Ann Arbor Space Society, a chapter of NSS. "Tee" is the editor of The Assembler, the newsletter of the Molecular Manufacturing Shortcut Group, also a chapter of NSS.]

## **Some Real Questions About Fermi's Paradox**

*That we find no traces of "visitors"  
does not mean that there are no "others"!*

by Peter Kokh

☞ Is casual interstellar travel sufficiently cheap or easy to support the view that intelligent species that don't commit environmental-technological suicide must inevitably spread throughout the galaxy? That we understand the physics of a number of sub-light speed "drives" does not guarantee engineering (or mini-biospheric life-support) practicality.

"Seed & Spore Arks" equipped with robo-wombs- and robo-nannies and robo-parents to swing into action upon chance arrival at a suitably 'fertile' site need much less in the way of in-flight life support and supplies, and is an option not usually mentioned. Such arks, containing no living individuals, can proceed, even drift, one way at low speed. If they find "fertile ground" they switch into "germination mode". If not, then not, and so what - like the scattering of seed. All that is important to the scattering sender (civilization) is that some few arkseeds succeed to germinate in a new location. But not every species may be physiologically or psychologically able to accommodate or realize the robo-assists needed upon arrival.

☞ The universe is so vast in both time and space that a natural quarantine may work to prevent the rise of sufficiently neighboring and sufficiently contemporary civilizations that would sooner or later come into ongoing or even "two-ships-in-the-night" passing "contact". The "Galactic Club" (\*) is not something that we can assume *must* exist, or from whose non-

existence we can with arrogance dare to presume our uniqueness. (\*) "The Galactic Club" by Robert Bracewell

➤ Cultural need to expand and the socio-economic-political wherewithal to do it, may be a temporary phenomenon of a species' "childbearing years". In many species, such as the Octopus, the physiological changes that allow reproduction, also set the stage for the death of the mother shortly thereafter. In like fashion, it is conceivable that the technological-environmental fallout of industrializing to the point where a civilization can reproduce mini-pockets of itself and its womb world's flora and fauna off planet may be tragically fatal to the cradle world. We have only one example and the jury won't be in on that question for a long, long time.

➤ Is the broadcasting of messages "to all points", continually over centuries, if not millennia, cheap enough that expanding civilizations will devote resources to it indefinitely? In contrast, it will be *much, much* cheaper and require vastly less effort to send brief narrow beam messages to known waiting audiences, i.e. offspring-alumni pockets of one's own species spread out in some diaspora. "Silence" means only that it makes sense/¢ for everyone to listen, but for no one to speak, a universal mismatch. [See MMM #61 DEC 92 pp 8-9 "Sending"; "Cheshirecasting" - republished in MMMC #7]

➤ The apparent belief that intra-galactic expansion will proceed smoothly and uniformly in all directions and that there will be no overlooked backwater pockets in less promising areas either implies ignorance of galactic "geography" and/or an unexamined assumption that the nature of the local interstellar "terrain" will be irrelevant to travel ease. [MMM # 61 DEC '92, p. 6 "Galactic Topography 101" - republished in MMMC #7]

➤ A belief that interstellar "Visitors" will find (would have found) some way to leave relics of their presence *on home planets*, relics that will (would have) *endure(ed)* for geological ages, *and* be readily discovered by adolescent puppy-dog civilizations like ours, is rather puppy-dog brash. - "Visitors" happening by *through the eons* (there is nothing cosmically special about our fleeting contemporary era!) are more likely to look (have looked) for geologically enduring safe repositories like lunar lava tubes that offer the further advantage of not being discoverable or explorable *except by maturing* space-faring civilizations that have already reached an appreciable level of post-adolescent planet wide cooperation - and *we are not* at that point, not yet. [See Selenology, (Quarterly of the American Lunar Society) March 93 Vol. 12, No. 1, "The Moon as an Attractor of Alien Artifacts" by Alexei Arkhipov]

➤ That colonizing species will covet worlds where life has begun to evolve and has the chance to flower on its own, presumes that such imperial predation is the only logical option. A more conscientious xivilization will be well aware of the sufficiently attractive expansive option of looking for suitable life-friendly worlds around shorter lived slightly hotter yellow-white "F" spectral class suns (our home star, "The Sun", is a yellow "G" spectrum star). Around such suns, life can begin only to be almost certainly nipped in the bud well before it can/could enjoy the billions of years (that, at least in our case, have proven necessary to allow impact-punctuated

otherwise rut-prone evolution to culminate in the rise of sapients). "F" stars are faster aging, typically dying in the 2-4 billion year age bracket, stable for less than half the main sequence lifetime of our own sun. In such cases, where life cannot be fulfilled without colonizing intervention, colonization by starfaring visitors must be an ethical plus. Races which understand this would be strongly motivated to *steer clear* of longer-living "G" type solar systems like ours, leaving them/us to seek an indigenous fulfillment à la "Prime Directive" of Star Trek culture. [see MMM # 45 MAY '91, pp. 5-6 "Welcome Mat Worlds" - republished in MMMC #5]

➤ Certainly we have as yet no grounds to assume that every life-cradle planet will be blessed with a sizable alluring moon and/or alluring neighboring planets (like our too-easy-to-romanticize Mars and our previously misenvisioned Venus). For us, the presence of these inner solar system assets and "destinations" has served to strongly incentivize exploration and travel beyond low planetary orbits.

➤ On broadcasts from Earth: only the carrier waves of the "I love Lucy" [Hitler's speech at the opening of the '36 Olympics in Munich was actually *the* front-wave salvo telecast.] or similar shows will be detectable several light years out. Of course, such waves could be construed as "evidence", but not evidence packed with a lot of gossip fodder about the sender.

➤ Bob Zubrin gave a fascinating talk at a recent MSDC on the detectability of starships using various forms of propulsion. Some would not be detectable beyond a few light-months out (e.g. approaching or leaving *our* system, or using our sun for a gravitational billiard-ball assist in change of direction). But other theoretically possible "star drives" would leave signatures detectable hundreds of light years out. Given the vastness of both time and space, there could well be a number of starfaring species in the galaxy but the likelihood of one that is both near enough *and contemporary enough* is not something that can be presumed. In fact, it would be a lucky throw of the dice, against all probabilities.

➤ Because of Earth's substantially deeper gravity well (Earth has ten times Mars' mass), it would be much more difficult for Earth rocks to be catapulted into escape velocity so as to have a chance of landing up on Mars, than vice versa. That there are terrestrial microorganisms that *could have survived such a trip* is not the question. It cannot be assumed that there is a "50-50" chance that the alleged Martian microorganisms have a lineage that began on Earth. Nor is there any evidence that these alleged Martian organisms, *only tracks and/or excreta* of which we think we have detected in these rocks found in Antarctica, had arrived here in a form "ready and able" to propagate, and thus to contaminate. All the evidence so far is in the negative.

➤ Some writers and investigators betray a thinly veiled personal psychological need to "find", and hold as an article of Faith that "we are alone". It is not necessary to have a "finding" or "conclusion" that humankind is a one-of-a-kind phenomenon in all the universe to motivate us to defend our cradle world against global biological-environmental disaster by impacting asteroidal debris. (Indeed such uniqueness could as reasonably be interpreted to mean we are some cruel Sisyphian cosmic joke than some God-cherished super-special



creation!) Our collective moral responsibility to seek survival of our species and of our host Gaian Biota, would be no less awesome a burden if we found instead the universe to be *generally* populated with billions of indigenous intelligent cultures. Whether or not other civilizations out there exist, does not condition the fact that we are unique, and worth saving.

In our own species, the fact that there are nearly six billion other living humans beside our own personal selves does not make our individual lives any less precious or worth saving and bringing to maximum fulfillment of personal potential. The answer to Fermi's half-baked Paradox has no bearing on the value-rating of the goal of species and biotal self-preservation. Nor has it any bearing on the value of exploring, developing, and settling our own Solar System at large, and of someday perhaps moving starward, "*ad astra*". We *need* to be a well-developed spacefaring species both to insure that the home world is protected and to insure that if (as it does the best hockey goalies) "one gets by us" (meaning a killer asteroid or comet), viable pockets of humanity beyond the cradle world would remain to carry on our civilization, its cultures, vast rich heritage and boundless aspirations. "Others" or not, this is some thing we must do "to be true to ourselves".

<PK>

[See also the discussion of how human spiritual sensitivity might be affected by the establishment of permanent presence beyond Earth in MMM # 97 JUL '96, pp 8-11 "Spirituality: Effects of the Lunar Environment on Spirituality and on the Reinforcement of Personal Religious Sensitivities", P. Kokh. - republished in MMMC #10]



[A Major Contribution of Seminal Concept Papers to MMM. The following abstracts are the work of a significant brainstorming group in Seattle which has continued over a span of many years. MMM thanks David Graham and Hugh Kelso for permission to reprint these papers. It was their way of helping the MMM editor concentrate on putting together ISDC 1998. Seattle L5 was the first NSS chapter to adopt MMM as its newsletter, joining us for issue #18, September 1988.]

## SLUGS???

[About the acronym — if you have ever been in the Pacific Northwest, where slugs (cousins of snails, but without shells) are abundant, and individuals up to half a foot in length are common, this totem/ mascot is appropriate. — MMM]

**SLUGS** is an acronym for the Seattle Lunar Group Studies, an association of people from many walks of life that share a common interest in the advancement of the human species into extraterrestrial space. Our primary focus is Lunar colonization and the technology needed to develop from LEO to the full range of cislunar space. The primary assumption of the group is that once permanent Lunar bases are established, the Moon will become a jumping off place for the exploration

and development of the entire solar system.

SLUGS is a research group patterned after an engineering think tank. We are pathfinders on the leading edge of current aerospace R&D technology. We bring together multidisciplinary knowledge, thinking, methods, and research to solve problems relating to Lunar development and colonization. Our emphasis is on current, off-the-shelf technology that is proven, well understood, and generally lower cost than the technologies traditionally associated with aerospace flight hardware.

Once a question or topic of interest has been investigated and researched by the group, the results are written up for publication. SLUGS papers have been accepted and presented at the Lunar Bases & Space Activities of the 21st Century Conference of the Lunar Planetary Institute, the Engineering, Construction, and Operations in Space Conference of the American Society of Civil Engineers, and similar professional conferences.

Recent papers of note are "Comparing Structural Metals for Large Lunar Bases" presented at the American Society of Civil Engineers conference and "Lunar Base Design Concepts" presented at the Lunar Planetary Institute conference. (Reprints of these papers are available from SLUGS, see Appendix C.)

Additionally, SLUGS is looking at political, economic, legal, cultural, sociological, psychological and human factors affecting Lunar colonization. Our "projects we would like to tackle" list typically consists of four to five dozen subjects that need investigation. We are always interested in expanding our membership and thus our ability to investigate more topics. If you have an interest in the area of Lunar and cislunar space development, we invite you to check us out. There are plenty of interesting questions to investigate and another good mind is always welcome.

Weekly meetings are held in Seattle each Monday evening from 7:30 PM to 9:00 PM. Special working groups meet as needed to complete projects and prepare papers for publication. For information, contact David Graham at (206) 440-1255 or Hugh Kelso at (206) 789-3906.

What follows is a series of concept papers that SLUGS members prepared for the Space Exploration Initiative (SEI) in 1990. These concept papers are still relevant after the passage of seven years. Some of the concepts have become "hot topics" in current space development circles while a few shine less brightly than they did in 1990. Most are still very good food for thought and excellent jumping of spots for further research and discussion. There are twenty-five papers in the series. Most were submitted to both the SEI (AIAA) and the Stafford Report (Rand Corporation). The first six are republished in this issue of MMM.

<SLUGS>

### **Introduction — the 1990 Space Exploration Initiative**

At the request of the National Space Council, NASA prepared a 90 day study on its internal mission planning capabilities and methodology. This report was presented to the National Space Council on November 20, 1989. Upon review

of the report, the NSC determined that NASA's current planning policy and methodology was too internalized and too limited in scope. The NSC felt that NASA would benefit from an infusion of new, non-NASA developed innovation and new conceptual approaches to the problems of developing an aggressive space program.

Therefore, Vice President Dan Quayle, as Chairman of the National Space Council, directed NASA to conduct a major outreach program in search of new and innovative approaches to space program planning. This outreach was to extend beyond the usual aerospace and scientific communities and extend to all interested parties.

The National Space Council also approached the American Institute of Aeronautics and Astronautics (AIAA) requesting aid in the outreach program for new ideas and innovative approaches. The AIAA mounted an intensive effort to collect ideas from all interested parties. The format of the AIAA effort was a single page paper describing each concept submitted. These were then reviewed by a "synthesis" group charged with the responsibility of condensing all the incoming data into a set of mission goals, objectives, and policy guidelines.

NASA responded to the NSC directive with both in house programs and contract services by the Rand Corporation of Santa Monica, CA. The Rand outreach format was a two page concept description with an option of submitting a supplemental background proposal. The supplemental proposal was limited to ten pages. The Rand Corporation would then create a database of the ideas collected and submit the processed data to the "synthesis" group for final review and action.

The "synthesis" group was headed by former Astronaut Lt. General Thomas P. Stafford, USAF (Ret). It is the responsibility of this group to assess and evaluate this body of suggestions and ideas and develop specific recommendations regarding future space program objectives and policy. This information is to be presented to NASA and the NSC in mid-1991. The evaluation and assessment of the results of the outreach programs is ongoing at the time (1/1991) of publication of this group of SLuGS concept papers.

SLuGS responded to the solicitations of both the AIAA and the Rand Corporation. Thirteen papers were submitted to AIAA and twenty-five papers were submitted to the Rand Corporation. There was some overlap between the two submittals, thus a total of twenty-five concepts were presented. These submissions are collected here in their entirety.

Most of these concepts are currently the subject of deeper study by various SLuGS investigative teams. Others will be taken up as study projects in the near future. It is the collective opinion of SLuGS that these concepts deserve further investigation.

SLuGS continues to develop and explore new concepts in space exploration and development. These concepts are periodically offered to interested parties in hopes of stimulating investigation by other participants in the space development community.

SLuGS welcomes comments. To comment on current

or past projects, suggest new ones, or join one of our investigative teams, contact us at:

Woolly Mammoth Co./ECS  
Attn: David Graham (SLuGS)  
15254 Densmore Ave N.  
Seattle, WA 98133

<SLuGS>

## ***Sheet Piled Lunar Excavations***

(SEI & Stafford) by David D. Graham

Virtually all current lunar base designs involve substantial excavations of lunar regolith. The proposed structures are either wholly or partially buried and the regolith is mounded over the structure for radiation shielding. One popular design even has bagged regolith protecting the structure in "sand bag" fashion.

The problem with these designs is that all of them assume excavation and other handling of the lunar material will be done by pressure suited crews with or without the aid of lunar versions of bulldozers and backhoes. The number of EVA hours necessary to perform, in pressure suits, the amount of excavation and recompaction envisioned by most of these designs is unreasonable and entails exposure to dangerous amounts of radiation.

It is critical a construction methodology be developed that will minimize the amount of work performed in vacuum and on the surface where radiation exposure is a factor. A popular Earth construction technique minimizing the amount of excavation is sheet piling. Sheet piles are interlocking sheets of material (steel generally, but also aluminum, concrete and various plastics) that are driven into the ground by an impact or vibratory hammer. The native material is then excavated from between the sheet piles.

This would minimize the amount of material to be excavated as sloped trench walls would not be needed to prevent caving. The Handbook of Lunar Materials puts the angle of repose of regolith at 22 to 35 degrees. Without the sheet pile technology, considerable additional excavation would be required to create slopes not subject to caving in an open trench.

Once the regolith has been excavated from between the sheet piles, the Moon base structure is then placed in the excavated trench and the trench backfilled with regolith.

Sheet piling lends itself readily to automation. In all probability, the sheet piling operation could be accomplished by a teleoperated robotic machine controlled either from Earth or an orbiting lunar station. Thus crews need not be sent to the lunar surface until the sheet piling is complete. Sheet piles have an additional benefit of high packing density, thereby lowering transport costs. <SLuGS>

## ***Sheet Piled Lunar Pressure Hulls***

(SEI & Stafford) by David D. Graham

Sheet piling is a commonly used construction technique where interlocking sheets of steel (or aluminum, concrete, or various plastics) are driven into the ground

forming either a retaining wall or a closed structure. Bridges are sometimes built on artificial islands created from sheet piled caissons. After driving the sheet piles to create a caisson, water is pumped out of the enclosed space and the space filled with sand or other structural fill. On land, sheet piled excavations minimize the amount of material excavated and often become part of the structural wall. Sheet piles can be driven with sealants in the interlocks to form water tight walls.

On the Moon, sheet piling could both minimize excavation and serve as the pressure hull for large structures. The sheet piles could be driven in square, rectangular, or circular configuration. By incorporating a suitable sealant in the interlock, the sheet piled wall becomes the primary pressure hull.

Once the enclosed regolith is excavated to the desired depth, a floor and roof section is attached to the sheet pile walls. (Incorporation of a modular, prefabricated air lock assembly is assumed.)

The roof is then covered with sufficient regolith to provide radiation shielding and the structure pressurized for use. Additional sealant is then applied to the sheet pile joints as necessary from within the structure. The internal structures can then be assembled in a shirt sleeve environment at much greater worker efficiency than assembling the base in a vacuum with a pressure suited work force.

The internal habitats and equipment of the lunar base are shipped to the Moon in kit form allowing greater packing densities than would be possible with assembled, prefab units. This simplifies transport logistics and helps lower costs by reducing the number of flights necessary to deliver the lunar base components to the Moon .

The result of combining the sheet pile technology with dense pack kits is the ability to rapidly assemble habitats and research or work space structures of much greater volume than would be practical to transport to the Moon as prefabricated units. Work space could now be planned to accommodate the needs of the tasks and/or experiments rather than compromising the task or experiment to fit the volume allowed by the shuttle cargo bay. <SLUGS>

## ***Lunar Base Construction by Regolith Tunneling***

(SEI & Stafford) by David D. Graham

The information brought back by the Apollo missions regarding subsurface characteristics of the lunar regolith indicate very high compaction of this material. Further studies performed on lunar simulant by Bernold & Sundareswaran (Laboratory Research on Lunar Excavation, Space 90 proceedings published by ASCE) indicated that the lunar regolith is almost totally lacking in voids and is compacted to the maximum possible for that material.

NASA examination of the lunar regolith samples from the Apollo missions reveals that grain structure is very angular and sharp. The granules are completely devoid of any weathering or rounding of the individual grains. At high compaction percentages, the internal friction of this material would be enormous.

This suggests an interesting method of lunar base construction. Without voids and with a compaction density approaching 100%, the lunar regolith at depth would be relatively impervious to an atmospheric. An atmosphere to regolith interface would be essentially "air tight." With little or no penetration (leakage) of the atmosphere across the air/regolith interface, tunneling through the regolith suddenly becomes a very attractive possibility.

A bore pit would be constructed (sheet piling is a common technique on earth) in the regolith to gain access to the regolith at a depth of approximately 17 meters. At this depth, the overburden weight of regolith on a 5.5 meter bore at 1/6G would resist an atmosphere of about 9 psi. The overburden would also provide radiation shielding.

A boring machine could then begin tunneling through the regolith. A tunnel size of 5.5 meters (18') in diameter would allow ample living and working space (10' ceiling by 15' clear span floor). The air pressure in the tunnel would balance the weight of the surrounding regolith and, because the regolith is nearly air tight, would allow the crew to work in a shirt sleeve environment.

As the boring machine tunneled through the regolith, a light coating of a pliable, latex like material would be sprayed on the tunnel walls forming a positive seal. This seal layer would both prevent what little leakage of atmosphere naturally occurs while also preventing sloughing of regolith from the tunnel wall. The result would be an inflatable structure in situ. A possible refinement would be to slip form lunar concrete behind the boring machine for a rigid structure not dependent on air pressure for its structural integrity.<SLUGS>

## ***A Vacuum Operated Lunar Excavator***

(SEI & Stafford) by David D. Graham

Excavating material on the Moon will prove very difficult because of the environment (vacuum and high radiation) and because of the very abrasive nature of the lunar regolith. Coupling these problems with the weight and bulk of excavation machinery makes the mobilization logistics of a lunar excavation operation needlessly expensive. There may be a light weight alternative to transporting the lunar equivalent of backhoes and bulldozers to the Moon .

By enclosing the area to be excavated with sheet piling, a pressure tight containment wall could be built around the site. The sheet piles would be left extending above the surface three to four meters. The area inscribed is then capped with a roof attached to the sheet pile walls. Placed near the center of the roof is a rotating pipe penetration of twenty to thirty centimeters in diameter. To this rotating pipe is attached a flexible hose on the inside of the structure and a semi-flexible pipe on the outside. The internal flex hose is fitted with handles and several scarifying teeth similar to a rototiller. The structure is then connected to a large reservoir of gases scavenged from the lunar regolith via a solar furnace.

Pressure suited crew then excavate the structure floor by pressurizing the structure and using the pressure differential

to move loose regolith through the pipe. Other workers on the outside of the structure direct the placement of the excavated regolith by pointing the semi-flexible pipe. A protective layer of regolith is gradually built up on the roof as a result of the interior excavation.

This method consumes a large quantity of volatile gases but requires little mass for excavation machinery transported from Earth to the Moon. The gases could be cooked out of the regolith by a brute force solar furnace. It is not necessary to separate and purify the gases. Any mix of gases will suffice. All that is necessary is a pressure differential.

This may not be the method of choice for all lunar construction, but it may be the best and quickest way to excavate the first large structures. Less equipment would be brought up from earth and probably fewer men would be required to complete the excavations.

<SLuGS>

### ***Balloon Launch of Small Rockets***

(SEI & Stafford) by Stan Love and Jeff Klein

The greatest problem with current attempts to develop space is the tremendous cost of putting mass into orbit. Present technology sets strict limits on the amount of propellant required to lift an object from the surface to orbital altitude, and to accelerate it from Earth rotation velocity to orbital velocity. Additional costs arise from construction and maintenance of complicated ground facilities for launching rockets of even modest size. Both of these costs can be reduced to some degree by launching from altitude, a technique which the recent success of the Pegasus vehicle proves to be workable.

Additional benefit could be gained by using a balloon rather than an airplane as a launch platform. Unlike airplanes, balloons use buoyancy to lift, and hence consume no fuel. The altitude limit for balloons is roughly 25 km, twice the ceiling of a B-52. High altitude launch has several advantages. It reduces the amount of fuel needed to reach orbit, and cuts down on the energy lost to atmospheric friction during ascent. In addition, launch from 25 km avoids the environmental issue of having lit rockets ascend through the ozone layer which lies at 20 km altitude.

Balloons have a critical disadvantage in that they cannot be steered (although the payload can be mounted on a steerable platform,) but tethering the balloon would solve most drift problems. Generally, a balloon is expendable, and cannot carry more than a few thousand pounds aloft. In advanced scenarios, large tethered balloons could be flown with hydrogen gas for buoyancy. Some of this hydrogen could be used to fuel the rockets carried aloft, so that the propellant in effect lifts itself to 25 km altitude! Replacement hydrogen could be piped up the tether from the surface. If weight permitted, an apparatus for extracting liquid oxygen from the atmosphere could be attached to the balloon, so that none of the oxidizing portion of the rocket's fuel would have to be lifted from the ground.

<SLuGS>

### ***Replenishment of an Orbital Propellant Depot by Means of a Coil Gun***

(SEI & Stafford) by Rodney Kendrick

For trips to geosynchronous orbit, the Moon, or beyond, a low Earth orbit fuel depot is essential. This proposal describes a method for resupplying an orbiting depot with up to 14,000 kg of propellant (produced from water ice) daily. Water is dense and inert, yet when electrolyzed and liquefied, it can become a high energy propellant.

A recent article (Breck, Henderson, "Sandia Researchers Test 'Coil Gun' For Use in Orbiting Small Payloads." Aviation Week and Space Technology, May 7, 1990, pages 88-89) described the capabilities of a "coil gun" for launching payloads into low Earth orbit. This coil gun would replace costly rocket propulsion with cheap electricity.

This proposal calls for building a coil gun and rocket combination capable of placing a 10 kg payload of water ice in orbit. The gun would be sited on the equator and fired due east. A very small maneuvering motor would circularize the orbit at 277 km altitude. Firing one shot every minute would thus produce a ring of orbiting payloads about the Earth.

The depot would orbit at 300 km at an inclination of zero degrees. It would consist of tankage, electrolyzer, liquefaction machinery, power plant, and a 23 km tether. This would extend down to the 277 km orbit with a large net at its end. The end of the tether would not be in orbit, and the orbiting payloads would pass through the opening of the net at a closing velocity of 40 m/s where they'd decelerate and be captured. Thus a difficult rendezvous maneuver would be avoided. The captured water ice would then be pumped up the tether to the depot.

Economies of scale could come into play. With up to 500,000 shots a year, the price per shot should be quite low. The per year payload equivalent will be that of over 40 Saturn V's.

<SLuGS>

### ***An Energy Factory Near the Sun***

(SEI & Stafford) by Mark Lawler

Large geosynchronous solar power satellites have been envisioned to convert sunlight into electricity and thence into microwave transmissions to Earth. A perfectly efficient 1-GW solar power satellite would be 8.5 km square. Lofting the construction materials for such a large spacecraft into geosynchronous orbit would be very costly. Solar energy collection will be even more expensive at Mars and beyond because of the great distance from the sun and the need for much larger collectors.

Building a solar collector in Mercury's orbit instead, or even closer to the Sun, can achieve significant savings in the amount of necessary materials. Mercury's semi-major axis is 0.387 AU, so the solar input there is on average 6.6 times that near Earth. Thus a 1-GW solar collector near Mercury would have 1/7 the area of a collector near Earth - with correspondingly lower mass and expense required.

Mercury, with its abundance of metals, might economically supply much of the construction material for such a power station. Launch of materials from Mercury would be relatively cheap, since escape velocity from Mercury is 4.2 km/s, compared to 2.4 km/s from the Moon and 11.2 km/s from Earth.

No feasible means exist so directly transmit energy across vast distances such as between Mercury and Earth. Instead, antimatter could be produced at the power station and launched toward users elsewhere in the solar system. 175 grams of antimatter reacting with a like amount of matter will produce the raw energy equivalent of a year's output from a 1-GW power plant. Costs to transport such small masses would be minimal. Robert Forward has studied the antimatter production problem extensively and while finding significant technical obstacles to efficient antimatter production; he has also identified possible paths to overcome them through a vigorous research program.

An inexpensive and inexhaustible supply of antimatter shipped about the solar system in tiny transfer spacecraft could supply the energy needs for asteroid belt missions, lunar bases, space stations and industrial facilities, Earth-Mars transfer vehicles, and Earth itself. Antimatter could be used to generate relatively clean electrical or thermal power, and in propulsion systems as suggested by Forward.

A major drawback of antimatter is its potential use in weapons of mass destruction, so shipments may have to be guarded or monitored. Yet antimatter produced close to the sun could become the principal fuel for developing a spacefaring infrastructure and help to solve energy needs on Earth. <SLUGS>

[As the Earth Turns ...]



# Earth: Color Medley Calendar in the Moon's Nearside Sky

by Peter Kokh

[Astronaut quotes below were passed on to us by Cynthia Griffin, Space Research Associates, and are from remarks they made to an audience of military personnel and civilians at the May '97 National Museum of Naval Aviation's annual symposium]

In "Seven Wonders of the Moon" [MMM #69, OCT. '93, p. 8] the view of Earth, hanging there perpetually in the Nearside Sky was listed as one of them. We billed it as "an apparition in the lunar nearside heavens with 3 1/2 times the breadth, blocking out 13 times as much of the starry skies, and shining with 60 times as much glaring brilliance as does the Moon as seen from Earth — all in a spinning ever changing marbled riot of blues, greens, browns, and whites."

## Earth as Clock and Calendar

Earth-in-the sky will offer future Lunans endless fascination as well as a psychological anchor (for better or for worse) for their morale. More on these benefits later. First we want to outline how Earth offers clues to (a) the time of the lunar month or "sunth" as we've more aptly named it, (b) the time of [calendar] day or date, and (c) the time of the year.

**TIME OF SUNTH:** Earth-in-the-lunar-sky goes through the same series of sunlit, night-darkened phases as does the Moon in our skies — with some spectacular differences. "New Earth" when eclipsing the Sun during what the Earthbound interpret as a Lunar Eclipse will appear as a dark circle in the heavens crowned with the fiery ring of the sunset-sunrise line as sunlight scatters in the dust of Earth's atmosphere. At this and other times, the night-darkened portion of the globe has become in this century increasingly "star-studded" with the city lights of burgeoning urban areas as well as oil and gas field burnoffs of "waste" natural gas and hydrogen. Meanwhile the frequent reflection of the Sun off ocean and ice accentuates the sunlit portions.

The point, not to wander in wonder, is that New Earth corresponds to Full Moon (the entire Nearside hemisphere in dayspan); First Crescent Earth to the waning Moon (nightspace advancing from the east over Mare Crisium etc.); First Quarter or "Half Earth" to nightspace having advanced to the central meridian of Nearside, dayspan advancing to the central meridian of Farside, etc. In other words, as seen from each other's surfaces, the phases of the Earth and of the Moon are *opposite*.

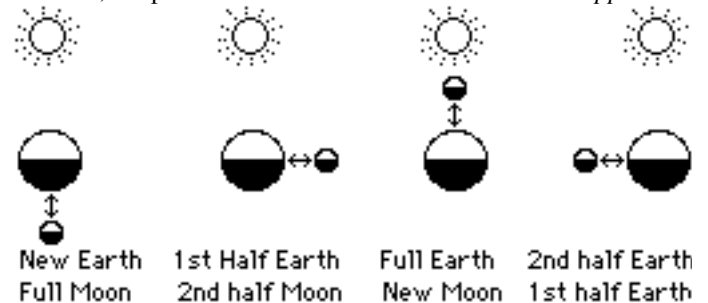

## MMM #107 - JUL 1997

### Looking Back at Earth



A 'neat' button I saw at some science fiction convention a few years back boasted "Happiness is seeing Earth through your rear view mirror." The sight of Earth from afar will always be the occasion of pride in achievement - "we've made it - we've broken out of the Cradle!" But more than that, Earth just "hanging there in space" will be a vision that for many nearside Lunan pioneers will serve as a psychological umbilical to their roots.

That aside, the vision of Earth from anywhere, in itself will present the most colorful, most ever-changing, most fascinating, most inarguably beautiful sight to be seen from any vantage point anywhere in the Solar System.

In practical terms, the lunar nearsider will be able to deduce from the Earth's "phase" what is his local "time of the sunth": just after local daybreak, dayspan morning, dayspan afternoon, etc. Of course this will differ according to where the viewer is on the nearside (i.e. at which meridian).

#### **TIME OF DAY (DATE):**

While the Moon keeps the same face turned toward Earth at all times, Earth-in-the-Moon's-sky turns on its axis once every 24 hours. Whether the viewer sees the Americas, the Atlantic, Europe & Africa, Asia and the Indian Ocean, or the Pacific as facing him, will tell him what portion of the local 24 hour date it is (distinguishing date from the 14.75 date long dayspan and the 29.53 date long sunth). Depending on how Lunans set up their local calendar and time reckoning rubrics (that is if they do not import unchanged the time reckoning system of Earth), the above concordance may be fixed or it may precess by an hour every 40-41 days if Lunan calendar is set up as I've suggested (so that there are exactly 29.5 dates per sunth, rather than 29.5306).

#### **TIME OF YEAR (SEASON):**

How the Earth's axis tilts with relation to the Lunan observer at different times of the sunth, will tell him the time of year. The tilt will shift full cycle through the sunth (sequence of phases). If at 1st Half Earth, the north pole tilts toward the right (towards the Sun) it is northern summer, southern winter Ditto at 2nd Half Earth if the tilt is to the left, at New Earth if it is away from the observer, and at Full Earth if it is towards the observer, and so on.

Accompanying the tilt will be confirming visual clues: snow cover in higher Northern latitudes or in higher Southern latitudes corresponding to that hemisphere's winter, the other hemisphere's summer, and so on. Yellow-oranges replacing green shades in temperate zone forests will indicate Fall in that hemisphere, Spring in the other hemisphere. More seasoned observers will be able to recognize seasonal clues in between to give a better approximation.

#### **Pattern Watching**

On the ball Lunans will be able to look up at Earth and tell the time of day (date), a close approximation of the date of the sunth (month), and which sunth/month of the year it is — all at a glance. It is the *spectacle* of Earth, however, that will turn that glance into a lingering observation, the seer into a transfixed looker. While Earthbound students can patiently study an all but changeless Moon, lunar settlers and visitors looking up at Earth will have an unending drama of riveting kaleidoscopic change to admire and study. It will be a treat without the distraction of flora and fauna and weather in the foreground, a Van Goghish canvas of color understatedly matted by black sky and gray regolith.

The first impression will be of ever changing cloud patterns; of hurricanes, cyclones, and typhoons; of storm fronts. Playing hide and seek with the shifting clouds will be the blues of the oceans and lakes and seas, the greens of grasslands and forests, the light tans of the deserts, and the glaring white of snow and ice. Beyond the day/night terminator, again playing hide and seek with the clouds, will be a light show extraordinaire: lightning and forest fires on the

natural side, city lights and oil and gas burnoffs added by man. Different observers will see and watch for different things, each according to his/her own interests. Some will habitually count lightning strikes, jotting numbers in a log. Others will try to catch a glimpse of the light patch that locates their hometown lights or the lights of other towns, cities, and urban industrial archipelagoes.

Relatively few sets of elements will contribute to the never repeating sequence of Kaleidoscope treats. Not all the elements will appear with the same frequency: for example, the appearance and track of the approximately 60 mile wide Moon Shadow across the lit face of the Earth during what terrestrials experience as locally very rare Total Solar Eclipses. And the relatively glare-free conditions of solar eclipses (which we experience as eclipses of the Moon), many fainter night side light glows may become visible to the practiced lunar observer.

#### **"Humansign": Earth as an Inhabited World**

That Earth is an inhabited world will be quite apparent. In the night portions of the observed face we will see the city lights, some unnaturally frequent forest fires, and the oil field gas burnoffs. In the sunlit portion of the Earthglobe we might see some agricultural patterns, and even detect portions of national borders betrayed by differing land use patterns on either side. We'll also see slow changes from advancing deforestation and desertification. Man-made reservoirs will catch the sun glint where once their was all-but-undetectable river valley. And we'll spot natural floods that are here and their 'controlled' by man-taken measures. All these signs will be studied acutely by those keenly interested in the great unplanned experiment of environmental "deterraforming", going on more or less continuously since the invention of slash-and-burn agriculture in Europe some eight thousand years ago.

For those fascinated by Earth's city lights and their identification, an amateur observing league may give out "Edison Certificates" to those who have correctly identified a representative selection of a hundred-some urban concentrations - much like the Messier Certificate Program in which backyard astronomers seek to identify star clusters and nebula on an early and popular list of the brightest such objects. Advanced observers will be on the watch for blackouts, major fires, night launch rocket booster burns as well as fiery night side reentries.

For the Earthborn, night lights of homelands and hometowns and spaceport points of departure will hold special interest. For native born Lunans, night objects sought out will include a less predictable list of various places they've each heard and read about, and which have fired their imagination.

#### **Naked eye observation of Earth**

Full Earth illuminates moonscapes with sixty-some times as much brilliance as Full Moon brightens earthscapes. But without a dust and water vapor laden atmosphere on the Moon, Earthside shadows will be inky black and impenetrable. A happy result is that starlight is not drowned out.

Yet not all lunar settlers and visitors will be able to appreciate Earth-in-the-sky with equal ease. To paraphrase the opening sentence in Caesar's report on the Gallic Wars, "All Luna can be divided into four parts".

In the central portions of Nearside, Earth is either directly overhead or at a very uncomfortably high angle above the horizon. We might nickname this central area *The Crooknecks*. It includes most of Mare Imbrium, Mare Nectaris, Mare Serenitatis, Mare Tranquillitatis, Mare Nectaris, Mare Vaporum, etc.

*The Postcardlands* are the peripheral stretches of nearside, regions in which the Earth hovers perpetually a comfortable 5-40° above the horizon. Adjacent to these, straddling the “limb” of the lunar globe which forever keeps the same side turned towards Earth are *The Peek-a-boos*. As the Moon’s axis is not perpendicular to its orbit around Earth and because that orbit is somewhat eccentric and the Moon travels faster when nearer Earth and slower when further away, all the while rotating at a fixed rate, about 7° to either side of the 90° East and 90° West lines are alternately turned towards Earth and away from Earth, psychologically annexing about 9% of “Farside” to Nearside.

Together the above three regions cover 59% of the Moonglobe. The remaining 41% might be dubbed the *Obliviside*, the Farside heartland from which Earth is never visible - and as the old saying goes, “out of sight, out of mind.”

### Special Observing Equipment

Special equipment will not, without signal relay, make it possible for deep Farsiders to observe the Earth. But in Greater Nearside, if we might call it that, many of those enthralled by the sight of Earth will be motivated to go beyond Earth-facing picture window portholes in their shielded abodes.

Oculars and binoculars will be among the simplest terrascopic assists, along with large Fresnel lenses or projection lenses in front of windows, much as late 40s/early 50s small screen TVs used similar fore screens to magnify the view. Special amateur optical telescopes designed with the aperture above the surface, but the observer eyepiece optics within the pressurized habitat for direct shirtsleeve observation will be popular with purists.

But for others, HDTV monitors, interactively zooming in on selected portions of the Earthglobe, will provide even better views. There might even be a dedicated fully interactive yet live Earth View Channel offering not only spectacular live detail, but also multi-spectral false color enhanced imaging that cues in on ultraviolet, infrared and other cues in the more complete light spectrum. Various interactive programs may search on demand for lightning flashes, pick out keyed in cities or other locations, even overprint city names of areas on which the viewer has focused in. Instead of the view from the Moon, auxiliary channels could give the view from LEO and GEO satellites, or even from future flank observation outposts in L4 and L5.

As on Earth, some avid observers will be heavily into photography, others into interpretive drawings, and yet others into raw and immediate unfiltered live observation. Yet glare reducers and variable masks for night side viewing will be standard (and the automatic default setting on TV).

### Earthsight as an Umbilical Fix

The riveting sight of Earth will be the chief anchor with ‘reality’ and with the heritage of their individual pasts for the early Lunan pioneers.

“Landing on the Moon was not nearly as over-powering and as memorable as just going to the Moon and looking back at Earth. We went to explore the Moon, and in fact discovered the Earth.”  
— Eugene Cernan.

Looking out the Apollo Module porthole from out around the Moon, Apollo 8 and 13 astronaut James A. Lovell, looking back at Earth, was able to block it out with his thumb. Later he recounted, “Everything that I ever knew - my life, my loved ones, the Navy - everything, the whole world was behind my thumb.”

One can argue if this is good or bad. Deep Farsiders may tease Nearsiders about their mommy-fixation to Old Earth, boasting of a keener, deeper openness to the Universe at large, and of a greater space-hardiness that results.

We’ll see. <MMM>

## Low Orbit Resorts “Niagara Falls” for Lunans

by Mark Kaehny and Peter Kokh

Given all that Lunan pioneers will have to sacrifice in forsaking the home world, its beauties, its comforts, its amenities, its adventures for the rough-edged frontier and its unforgiving character, it would be natural to expect that Earth would be far and away their favorite vacation destination. But as much as they might desire it, for those who’ll have been on the Moon a long time, years or more, “going home” even for a visit, will not be that easy.

Individuals who have spent up to a year or more in orbit have needed weeks to regain their Earth-honed muscle tone and strength - no way to spend the precious short time of a vacation. Sixth-weight, the fractional 1/6th G experienced on the Moon will not invite so drastic or complete a physiological deterioration as does the zero-G of orbit. Nonetheless, given enough time, especially time without exercise adequate to retain Earth muscle tone, returning to Earth for a visit will be quite a challenge.

Maintaining full “hexapotency”, the capacity to “handle” a gravitational environment six times as demanding as that of the new world they’ve come to adopt, will require a struggle that many, perhaps most, will abandon — especially once they’ve lost all reservation about staying on the Moon for the balance of their lives, once they’ve found their new lives, hardships and all, sufficiently rewarding. Staying in shape for an Earth return visit will take time, determination, sacrifice, and more likely than not, money.

Getting back in shape, after surrendering to acclimatization to the lunar environment will require even more effort and pain-gain swap than staying in shape in the first place. There will be those who will work at it sufficiently to be able to handle a return. Just as certainly, there will be more who don’t.

To put the challenge in perspective, Earth’s surface gravity is more than twice as forbidding, gravity wise, for the Moon-acclimatized as Jupiter’s surface (if it had one) would be, gravity-wise, for us terrestrials. No one would want to go to a Jupiter aerostat station where he would weigh 265% his normal weight - all the time, without relief. Why then would

we expect a fully adapted Lunan, even one born on Earth, to relish going somewhere where his weight would jump 600% - all the time?

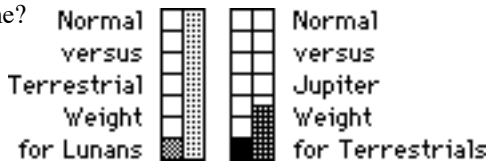

For most Lunans, Earth, however tantalizing, will be out of the question as a tourist destination. Virtual Reality parlors, travelogue videos, magazines and other armchair approximations of a visit to Earth will be the options of choice.

But Lunans *could* return to Earth, at least Low Earth Orbit, in complete comfort, staying at LEO resorts and orbitals offering artificial sixthweight, Lunar gravity. No, they would not get to walk the green hills of Earth again, not under open blue cloud pocked skies. But here in orbit they could hover in comfort over the brink of the gravity well, much as honey-mooners perch on ledges over Niagara Falls.

From this Olympian vantage point, they could sample the wonders of Earth-in-the-sky that they have always enjoyed back home on the Moon - in much greater detail and immediateness and in a field of vision fullness that IMAX can only emulate. Much as the first lunar tourists will skim over the Moon's surface without landing in Apollo 8 type orbits, so these first Lunan Earth tourists will enjoy what they can without landing. Sixthweight orbitel wings that cater to Lunans might be lavishly and expensively furnished Earth style (plenty of wood, leather, fabrics horrifically expensive on the Moon) to enhance the Earth-visit experience.

Lunans will prefer sixthweight orbitels in higher inclination orbits so that they can see up close more of the Earth's surface. An inclination in the 60-65° range would present them with all the inhabited continents plus the fringes of Antarctica. Higher inclination orbitels and resorts will need to charge a premium, however, reflecting the higher cost of original emplacement, continual resupply, as well as rendezvous fuel for those coming and going.

Meanwhile, a portion of such a lunar gravity facility or similar separate facilities (more affordably situated in equatorial orbits) that cater to Terrestrials, might be faithfully furnished Lunan style to enhance the let's-pretend Lunar visit experience. This resort option would be popular for terrestrials wanting a taste of what it feels like to be on the Moon, if they are considering such a trip or even emigration to the frontier.

Most Lunans would welcome such premiums - few if any Lunans would settle for the cargo class equatorial orbitels (geared to those who come mainly for the zero-G). Why pay so much and come all the way, and then let the fizz out of the view bottle?

Orbital closeups, after all, will come to be recognized as a legitimate way of visiting planets with extreme environments. We would surely balk at calling Earth's environment extreme. But someone on the Moon for many years, and surely those born there, will see it quite differently. Besides, even if, with the help of exoskeletal assists, they could manage the gravity, how could they handle being out in the open under that miles' high sky, without utter catatonic agoraphobia? Oh, horrors!

<MMM>

[Installation II of Concept Paper Abstracts Prepared for the Space Exploration Initiative (SEI) and the Stafford Commission by SLuGS - Seattle Lunar Group Studies - Reprinted with permission.]

## Cislunar Jerry

(SEI & Stafford), Gordon Woodcock and Joe Hopkins

We propose a vehicle be developed to utilize swing orbits (Woodcock, 1). The vehicle would be designed to travel in the lunar plane between Earth and Luna, providing frequent and regular access to both bodies.

This vehicle could be viewed as a cislunar ferry. In its initial form, the orbiter would be a small, no gravity, passenger/freight carrier. The cycling orbiter could be configured to provide radiation shielding for the passenger section. If gravity becomes necessary, it could be simulated by spinning equal massed compartments opposite each other on a tether.



[Actually, it is not necessary that both opposing components be equal in mass - *unless* equal levels of artificial gravity are required at both ends. If this is *not* required and the two components are unequal in mass, the center of gravity or fulcrum simply lies proportionately closer to the heavier mass while the gravity felt in the lighter more distant component will be the greater. - Editor.]

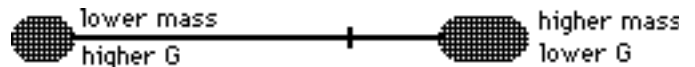

Regular, inexpensive transportation between the Earth and Moon is the main purpose of the orbiter. Cargo and passengers would be transported on and off of the orbiter in specially designed taxi modules. Passengers would generally remain on board for only one leg of the trip at a time; three to five days.

Over time, with a system like the cislunar ferry, transshipments from the Moon to low Earth orbit would become cheaper than such shipments from Earth. Early shipments could include oxygen, unprocessed lunar rock (for shielding) and agricultural products. As lunar bases develop, processed metals and glasses could be included.

Shipments from Earth to the Moon would be precision tooling equipment and electronic supplies. Organic waste generated onboard the cislunar ferry and in low Earth orbit could be sold to Moonbase farms. The orbiter would also be valuable as a research facility.

<SLuGS>

(1) Woodcock, Gordon R., Transportation Networks for Lunar Resources Utilization, Space Manufacturing 5; Engineering with Lunar and Asteroidal Materials, American Institute of Aeronautics and Astronautics, New York, Proceedings of the 7th Princeton/AIAA/ Space Studies Institute Conference, May 8-11, 1985



## ***Magsail Asteroid Survey Mission***

(SEI & Stafford) by Stan Love and Dana G. Andrews

The asteroids, lying principally between the orbits of Mars and Jupiter, have long been considered one of the best potential sites for near term access to extraterrestrial resources. To fully assess the value of asteroids for commercial use, and also to gain scientific knowledge about them which is critical to our understanding of the formation of the solar system, it is necessary to examine a large number of them a very close range, perhaps even collecting samples of their surfaces for analysis on Earth. Such a mission is unthinkable with current chemical rockets, however. Each flyby would require a few km/s of velocity change (hence approximately doubling the initial mass of the spacecraft) and no surface landings could occur without expending a prohibitive amount of propellant.

The magnetic sail (Andrews, D.G. and Zubrin, R.M., "Progress in Magnetic Sails," AIAA Paper 90-2367, 1990) suggests a solution to this problem. It would derive its thrust from the interaction of the solar wind with the magnetic field around a loop of super conducting cable several dozen km in diameter. As long as current flows in the cable (once set up, it will continue to flow indefinitely) the sail would develop a small amount of thrust, which could be directed by altering the orientation of the loop or by changing the current, easily accomplished with a modest-sized solar array. Since it would produce a continuous force without expending any propellant, a magsail could orbit the sun in the asteroid belt indefinitely, visiting tens or hundreds of objects at a relative velocity of a few km/s.

Asteroids possess no magnetic fields to hinder the use of a magsail. Neither do they have strong gravitational gradients, which are difficult for any low-thrust vehicle to overcome. If the mission profile allowed the necessary deceleration time, the spacecraft could rendezvous with asteroids to take samples of their surfaces. Proper alignment of the sail and the asteroid could be arranged so that the sail force and the gravitational attraction of the asteroid exactly balance one another, allowing samples to be taken of the surface from a motionless spacecraft. After sampling a number of asteroids, the spacecraft could return to Earth to drop off material samples and undergo routine maintenance. It could then return to the asteroid belt for further exploration. <SLUGS>

## ***Magsail Mars Missions***

(SEI & Stafford) by

Dana G. Andrews, Stan Love, and Joe Hopkins

Regular round trip missions to Mars could be undertaken using a magnetic sail, or magsail, spacecraft. A magsail would derive its thrust from interaction between the thin plasma of the solar wind and the magnetic field surrounding a current-bearing loop of superconducting cable roughly 100 km in diameter. Once a current was established in the loop, it would continue to flow indefinitely, providing thrust until the current was cut.

Directing the thrust could be accomplished by changing the orientation of the loop or by altering the current; both easily accomplished with a modest-sized solar array. The

magnetic sail concept was originated by D. G. Andrews in 1968, but was not feasible until recent developments in superconductors that allow for cable that could be kept below its critical temperature with a simple and lightweight passive cooling system.

An additional advantage of the magsail is that the current loop would generate its own magnetosphere, much like that of the Earth, but on a much smaller scale. The magnetic field of the sail would protect the spacecraft's payload (and, in particular, its living passengers) from most charged particle radiation, decreasing the requirement for massive and costly radiation shielding on manned missions.

A recent paper (Andrews, D.G. and Zubrin, R.M., "Progress in Magnetic Sails," AIAA Paper 90-2367, 1990) describes a manned mission to Mars in 2007 with an initial mass of 200 tons and a payload of 140 tons. This payload is comparable with the payloads of other low-thrust manned systems currently under consideration.

A flyby of Mars is projected 164 days after departure from Earth. The payload and crew taxi would return to high Earth orbit after a total of 668 days. The spacecraft could then be refitted for the next launch window, occurring 90 days after arrival. Since proper alignment of the two planets occurs at regular intervals and the magsail could make the round trip with time to spare, it could be used as a permanent facility cycling between Earth and Mars. <SLUGS>

## ***Magsail Stabilization of Lagrange Point Structures***

(SEI & Stafford) by Stan Love

In numerous schemes for the development of cislunar space, propellant depots, mass catchers, and other facilities have been proposed at the various Lagrange points of the Earth-Moon system. Of these five points, only two, L4 and L5 (at 60° leading and trailing the Moon in its orbit) are stable against the small, constant gravitational perturbations present in the system. The two Lagrange points nearest the Moon, L1 and L2, are probably the most useful for lunar missions. Facilities constructed there would have to be constantly supplied with propellant to compensate for gravitational perturbations, or they would soon drift into other, less useful orbits.

The magnetic sail (Andrews, D.G. and Zubrin, R.M., "Progress in Magnetic Sails," AIAA Paper 90-2367, 1990) suggests a solution to this problem. It would derive a small amount of thrust from the interaction of the solar wind with the magnetic field around a loop of super conducting cable roughly 100 km in diameter.

As long as current flows in the cable (once set up, it will continue to flow indefinitely) the sail would develop a small amount of thrust, which could be directed by altering the orientation of the loop or by changing the current, easily accomplished with a modest-sized solar array. It would be capable of making the necessary continuous orbit modifications without expending any propellant at all, hence eliminating the need for large resupply missions. Operating a mag-

sail in the near-Earth environment would require that some consideration be made of the Earth's magnetotail, but this would probably not impact the sail's usefulness.

Another advantage of the magnetic sail is that it could generate its own magnetosphere, much like that of the Earth, but on a much smaller scale. The magnetic field of the sail would provide good shielding against charged particle radiation for anything in its immediate vicinity, and would thus lessen the need for heavy and expensive radiation shielding of manned outposts.

<SLUGS>

## **Remote Lunar Geological Survey**

(SEI & Stafford) by Stan Love and Robert Lilly

For the development of a manned presence on the Moon, it is critical to determine the mineral resources available locally. The Moon is too large and travel across it is too difficult for a detailed, ground based global geologic survey to be feasible in the near term. An alternative to the collection of soil samples on the surface is determination of the soil composition via remote means. This could be done in a crude manner by observing the spectrum of sunlight reflected from the Moon. A more sophisticated method would be the use of laser Raman spectroscopy, wherein a laser is directed at the surface, with the spectrum of light scattered at wavelengths near that of the incident laser providing accurate determination of the composition of the surface. Laser Raman spectroscopy is commonly used at close range in the laboratory, but could be applied at longer distances.

Placing a satellite equipped with a 100 W laser in polar orbit around the Moon would allow a Raman survey of the entire body with a resolution as small as 25 cm. At 100 km altitude, the Raman signal (10<sup>-6</sup> of the incident intensity) would outshine full Earthlight. Sunlit regions could not be surveyed. A 10 cm telescope with a spectrograph and CCD detector aboard the craft would be able to obtain a spectrum, with a signal-to-noise ratio of 10, in roughly 200 seconds, less than the 1200 seconds it would take for the satellite to travel across the sky of a given point. Both telescope and laser would have to track with an accuracy of 0.5 arcsec.

Each spectrum, one CCD frame, would contain about 20 M bits of information. The spacecraft must be able to store at least 20 frames of data while out of sight of Earth, requiring roughly 50 M bytes of storage, perhaps on tape. Transmission of data to Earth would require a rate of at least 200 k bits per second for a continuous survey.

The most difficult aspect of this mission would be providing power for the laser, which would operate only over shadowed terrain. The power requirement of the rest of the electronic equipment is small in comparison with the laser's consumption, several kilowatts. Power must come from solar panels via fuel cells, batteries or other suitable sources. The expense of such a system would certainly be less that of a ground-based survey of similar scope, and the spacecraft could be retrieved at the end of its mission and redeployed to other bodies in the solar system.

<SLUGS>

## **Clear Span Lunar Base Structures**

(SEI & Stafford) by Hugh Kelso, Joe Hopkins, et. al.

We present a design for a lunar base that provides a generic, multipurpose environment; the location of which is not dependent upon natural geological features. Clear-span construction creates large open spaces that can be subdivided according to use and need. It could be developed along the lines of an industrial park with the flexibility to accommodate a wide variety of uses while at the same time providing varied services to its customers.

This design is of steel construction and is divided into upper and lower pressure areas. The upper area provides a pressure environment equivalent to two miles above sea level (9.5 psi) for agricultural use while the lower area provides an atmospheric pressure equivalent to one mile above sea level (12 psi) for habitation and work areas. Elevators which service the base also act as air locks between the pressurized areas.

Our design encloses a space 30 meters high and 50 meters square. A layer of excavated regolith would be spread over the top of the base and compacted to a depth of 10 meters. This would serve as both a shield against radiation and as a dead load to counter balance some of the atmospheric pressure within the base. Other uses for the excavated material might include the extraction of iron, oxygen, and hydrogen. The construction process of the base would be similar to that of a building on Earth, and could be repeated as growth requires.

This base concept permits many interior configurations. Services the base would provide include such things as the basic maintenance of the base itself, power, lighting, air, waste disposal, food, living quarters, recreational areas, communications facilities, computer support, and medical services. Modules could be configured to include fabrication and processing facilities, a gymnasium, park areas, conference rooms, media production studios, and whatever else was needed or desired. Heavy industrial processes, such as smelting, and other activities which may harbor health risks would be carried out in modules separated from those that house personnel.<SLUGS>

## **Survey of Earth-Crossing Objects**

(Stafford) by Stan Love

Asteroids whose orbits carry them across the orbit of the Earth are of extreme interest for a number of reasons. Only half of the estimated 1,000 such objects with diameters greater than 1 km have been discovered. Since Earth-crossing asteroids present a direct threat to all life on Earth, a large-scale astronomical survey should be undertaken to detect as many of them as possible.

Currently, knowing that such an object was on a collision course with the Earth would be of no use, as there exists no capability to alter its course. This unhappy state of affairs will change in the future, however, so a good knowledge of the population of 1 km objects in the inner solar system could prevent a disaster the likes of which have not been seen on Earth in millions of years.

Although the impact of a 1 km object would have dire consequences for most life on Earth, the chances of such a collision are comfortably remote: only about 1 in 100,000,000

per year. Some Earth-crossing asteroids are of interest for reasons other than fear of collision.

Many of these objects can be reached with only a few kilometers per second of velocity above Earth escape, and hence represent an important and relatively accessible source of extraterrestrial materials. Many such objects are thought to contain, among other useful resources, several weight percent of water present in hydrated minerals. An astronomical survey of such objects can determine not only their orbital parameters and hence ease of access, but can also produce indications of their basic chemical composition and likely available resources.

<SLUGS>

## ***Food Animals in Biological Life Support Systems***

(Stafford) by Stan Love

A great deal of research has been done regarding the use of plants as part of life-support systems for space habitats. Plants are excellent recyclers of air and water, and if the system is planned carefully enough and the substantial startup mass is allowable, a vegetable garden (equipped with a few mechanical devices, such as an oxidation reactor for waste products) in a space habitat can perform complete recycling of air and water for the crew, and also provide almost all of their nutritional needs.

In typical biological life support systems of this kind, about 3 percent of the dietary needs of the crew are left to be filled by outside sources, primarily as vitamin and amino acid supplements. The bulk of the diet, however, would necessarily be vegetarian, which may not appeal to all astronauts.

It is interesting to note the changes necessary in a biological life support system if it is required to produce even a modicum of animal protein for crew consumption. Let us assume that 10 percent of the crew's diet is to be derived from animals, such as rabbits or fish, grown along with the vegetables in a biological system. A generous estimation of the fraction of a meat animal that is edible and palatable (i.e. not hair or bones or viscera) is 50 percent.

Let us also assume that the a mass of living food animals equal to the mass of a person metabolizes air, water, and food at the same rate as the person does, again a generous assumption since small animals have higher metabolic rates than human beings. A general rule of thumb quoted in ecology is that raising an animal takes ten times the animal's weight in food. Using these very general rules, if 10 percent of mass in the crew's diet is animal products, twice that mass of animals (because the whole animal is not used) must be raised continuously, requiring 20 times that mass of plants to be fed to the animals.

The life-support system for the animals, then, requires 20 times 10 percent, or two times, the "acreage" as that for the human crew, effectively tripling the mass of the entire system.

In conclusion, it is probably not feasible to have a closed biological life-support system provide meat for its crew if mass is a deciding factor in the design. Astronauts in such missions will be largely vegetarian, in spite of any personal preferences.

<SLUGS>

## ***An Artificial Lunar Magnetic Field***

(Stafford) by Stan Love

The Moon possesses no magnetic field of its own. As a consequence of this, and the fact that it has no atmosphere, it is constantly bombarded by cosmic rays both from deep space and from the Sun. For human activity on the Moon over any length of time, great care will have to be taken to provide shielding from harmful cosmic rays. The Moon's bulk itself can provide more-than-adequate shielding from solar cosmic rays during local night, but solar flares cannot be counted on to occur only when the sun is below the horizon.

A far-fetched but effective solution to the shielding problem is to gird the Moon with a loop of superconducting cable bearing enough current to generate an artificial "bubble" in the solar wind large enough to contain the entire Moon. A current on the order of 1 million amperes should suffice. Once the current is induced in the cable, it will continue to flow undiminished forever, so the power requirements for such a system are negligible. The magnetic field would protect the Moon's whole surface, greatly reducing the flux of charged particle radiation both for permanent habitats and for astronauts working on the surface. It would also allow compasses to be used for orientation on the Moon .

Some drawbacks are the large initial cost of producing and laying the cable, and the fact that the artificial magnetosphere would probably generate zones of intense radiation similar to Earth's Van Allen belts, creating radiation hazards in lunar orbit. It would also prevent the solar wind from striking the Moon's surface, thus eliminating the primary remover of gaseous pollutants from the Lunar environment.

<SLUGS>

## ***Magnetic Radiation Shields***

(Stafford) by Stan Love

The powerful and wide-reaching magnetic field of a magnetic sail (Andrews, D. G. and Zubrin, R. M., Progress in Magnetic Sails, AIAA Paper 90-2367,1990) provides good protection against charged-particle radiation for its payload, and indeed anything inside its magnetosphere, as a secondary effect of the thrust it produces. There will be many applications in near-term space exploration for which thrust is required, but cosmic-ray shielding will: namely, any fixed activity taking place outside the Earth's magnetosphere. In such cases, shielding could be provided with a loop of superconducting material similar to a magnetic sail, but with a smaller dipole moment. The resulting magnetic field could protect an area a few kilometers across, and would produce negligible thrust.

Stations in geosynchronous or other high Earth orbit, permanent installations at the Lagrange points or in orbit around planets such as Mars or Venus, and bases on the surfaces of the Moon, the Asteroids, or any airless body without a magnetic field will all need to provide shielding for their inhabitants. Vehicles that travel routinely through the Van Allen belts would also benefit from having effective charged-particle radiation shielding. Surface bases may block radiation with thick layers of local material, but transporting large amounts of massive material for shielding is not economically sound for orbital bases when a lightweight loop of superconducting cable could do the job equally well.

<SLUGS>

## **Regolith as Propellant for Mars Missions**

(Stafford) by Brian Tillotson

This is a proposal to use a coaxial electromagnetic accelerator (a.k.a. coil gun or mass driver) as a rocket engine for a Mars mission. The proposed propellant for the outbound journey to Mars is regolith (dirt) from the Moon, and the propellant for Mars orbital maneuvers and for return to Earth is regolith from Demos or Phobos.

O'Neill proposed use of a coil gun or mass driver as a rocket motor which ejects inert material at high speed to produce thrust. Recent coil gun demonstrations show that technology is in hand to realize this propulsion concept. With this concept, raw regolith is a suitable propellant. Regolith is less expensive than other proposed extraterrestrial propellants, which require heavy equipment delivered from Earth to chemically process raw materials.

**Value:** Use of planetary regolith addresses two needs for Mars mission design: low IMLEO and protection of the crew from galactic cosmic radiation (GCR). The concept avoids the cost of launching propellant from Earth, and the regolith can be used as shielding for most of the mission.

Several other advantages are realized. Propellant is stored in a bag which is folded and launched empty from Earth; this gives less launch volume than liquid propellants which are launched in rigid pressure tanks. Neither cryogenic storage nor in-space fluid transfer technology is required. Smaller power systems are required than for ion-propelled vehicles. Crews need not crowd into a storm shelter during solar flares. The proposed Moonbase finds a clear purpose.

**Performance Characteristics:** Using assumptions described in the background paper, the proposed vehicle's Earth mass (including lunar infrastructure) is 24% lower than a solar electric ion-propelled vehicle's mass. GCR dose to the crew is cut by more than half. The required electrical power is only 26% as large as for an ion vehicle.

**Enabling Technologies:** Coil gun launcher technology is advancing rapidly. Development should be directed to two new areas: 1) coil guns as flight-qualified rocket engines, and 2) a coil gun launcher on the lunar surface.

**Relation to Mission Objectives:** This concept may be enabling or enhancing for a manned Mars mission in two major ways. First, it may be cost enabling or enhancing by reducing the mass of Earth material launched into space. Second, it may be medically enabling or enhancing due to reduction of crew radiation dose. By providing a rationale for lunar support of a Mars mission, the concept increases the political likelihood of a permanent manned return to the Moon

**<SLUGS>**

*"The Moon - It's just like Motel 6  
- a bucket of ice and no atmosphere!"*

Louise Rachel Quigley

MMM #108 - SEP 1997

**IN FOCUS**  **The Moon?**

**"Been there, done that!" — Not!!!**

That the media and a poorly educated public should take the view that "we've done the Moon, now let's move on" is understandable if discouraging. That one hears the same sentiment echoed by many space advocates is much more of a problem.

Perhaps any/everyone's estimate of "what needs to be done next" is colored more by the drumbeat to which they march than by cool, clear, hard reasoning. Turn of the century American philosopher William James showed in great depth just how much temperament predisposes "reason". Without attempting to be exhaustive, a first effort to list some of the different siren call drums we space-interested "hear" might be: Explorer, Tourist, Settler, Businessman. Myself, I have an ear for all of these drums, each of them raising a surge in my spirits. But it would be dishonest of me not to admit that my spiritual home base is as settler. The great variety of topics written about in MMM over these last eleven years are testimony enough to that.

Others do not hear that drum so clearly, or it raises much lower tides in their spirits. The explorers and tourists among us, unsuspecting just how much remains to be discovered and wondered at on the Moon, will naturally want to move on. Some would-be settlers, and many businessmen will want to consolidate our toehold on the Moon first, pointing out the greater logistic base such development will afford for further deeper exploration of the rest of the Solar System. It is always useless to argue against temperament. The universe is vast and it needs all of us. We must be wise enough to admit that and respect one another. I understand the lure of Mars, of Europa, of Titan. *I too* would be a Martian, a European, a Titanite.

That said, it must be pointed out that in any non-superficial sense, we have *yet* to do the Moon!

We did not get enough rocks and dust! Our samples from six scattered areas, a college effort, are far from representative enough. Nor are they enough in total quantity. Enough perhaps to let us uncover "what the Moon is *made of*", orders of magnitude too little to let us discover "what we can *make out of* what the Moon is made of." That deficiency has set NASA up as high priest over the samples, hoarding them so tightly, least we never go back for more, *that we are prevented from learning what we need to know to give us confidence that we can return to stay, self-sufficiently.*

We are forced to rely solely on ivory tower "research" too heavily based on *crucially inadequate* simulants. That in turn slows us down in developing a viable suite of feasible and serviceable lunar-derived building materials and alloys.

We have explored *none* of the literally thousands of linear miles of lavatubes which geological clues and photographic telltale signs give us a very high level of confidence we'll find - cosmic weather sheltered, dust-free hidden valleys many

thousands of square miles in aggregate area. We have sampled no central peaks (composed of upthrust mantle material), no polar permashade “cold trap” ice fields, no unflooded great impact basins (the farside thalassoids). We still do not know enough to piece together the Moon’s real origin, the presently in vogue Velikhovskyesque scenario notwithstanding.

We have yet to take advantage of the unique platform the Moon offers optic and radio astronomy both - vantage points of which the Hubble people can only dream. We have yet to visit to the “Peek-a-boos” lands of the lunar limb, much less explore the first square mile of the lunar farside except from orbit.

The Moon is a gift that we have “*anticippointedly*” unwrapped and discarded in a boredom revealing not *the Moon’s* shallowness, but *our own* lack of depth, after playing with it for just a few moments. But after all, back then our mindset was “moonandback” *one word*.

**QUESTION:** Can those so easily and quickly bored with the Moon, totally unable to imagine beneath and beyond appearances, quite incapable of recognizing opportunities staring us in the face, be trusted to be any more insightful when *they lead us* to Mars? Or - might we need new leaders, with proven track records in uncovering real possibilities and opportunities for “**reclamation**” [where have we heard that word?], i.e., for “finding resourceful ways to take ‘a barren wasteland’ and turn into a fruitful, productive oasis in which transplanted humans can take root, thrive, and pursue happiness”. How many of these “been-there-done-that people” have wasteland reclamation experience, or even reclamation brainstorming, in their resumes? These very same people *will* find on Mars, alas, *only more* “rocks and dust”, more endless expanses of “boring”, not-quite-as-hyped scenery, “unrelieved” frigid cold, and - and this is the bottom line - “no reason to return”.

What we are *sure* to get out of entrusting them with our leadership is *another* long “40 years wandering in the desert (of incapacity to imagine)” post-Apollo like retreat before these same people or their intellectual successors succeed in getting significant press for their “on to Europa” fad-charge.

In comparison to the general public, the space-disinterested, WE *space-interested people* are supposedly extra-imaginative, extra-creative, extra-resourceful, extra-attentive to hidden opportunities and possibilities. Guess what, folks? *Not!!!* <pk>

## ***Fermi's Paradox, The Great Silence, and The Singularity***

by Tihamer T. Toth-Fejel August 21, 1997

[See MMM # 106, JUN '97: p 3. *The Real Question About Life on Mars*, Tihamer Toth-Fejel; p 4. *Some Real Questions About Fermi's Paradox*, Peter Kokh.]

The possibility of life on Mars raises some hidden but staggering issues regarding our place in the universe, and finding some would impact us as much as the Copernican Perspective did hundreds of years ago. In a nutshell, finding

life on Mars would intensify the Fermi Paradox in that with two successes out of two possibilities, it would seem that the universe should be teeming with life, and the aliens should have already been here. But they aren't.

All Space activists are united in the belief that we need to be a Spacefaring species to insure not only that our home world is protected from K/T class meteorites, but that if one does somehow get past us, then viable pockets of humanity beyond the cradle world would remain to carry on our civilization. Therefore, the answer to Fermi's Paradox has little bearing in our day-to-day lobbying and other grassroots pro-space efforts (unless we run into SETI enthusiasts) and in fact, won't be relevant until we finish settling our Solar System. After that point, the resolution to Fermi's Paradox will be critical to our survival as a species. It is very difficult to devise strong theories based on one data point. But it's so much fun, especially when the philosophical implications of these theories are so overwhelming.

It has been said that the possible existence of aliens does not make our species more or less valuable. I disagree, for while the rareness of something often makes it more valuable (e.g. large diamonds), rareness does not necessarily make it more valuable (e.g. the last stack of papers I tossed on the recycle pile contained many unique random numbers, plus my notes, stains from my lunch, etc.).

Ted Reynolds' allegorical tale "Can These Bones Rise" (Analog, March 1978) illustrates that, we can and should make judgments on the differential value of cultures and species, including ourselves. For those who have not read his story, it is set in a time long after the extinction of humans. One woman is resurrected by a race of aliens who tell her that they will raise the rest of Earth's dead if she gives them a good enough reason to do so. Reynolds' point is that there are objective values that transcend the parochial mindsets that individuals and individual cultures may have, that at least some species will value characteristics such as physical or political power, beautiful art, or unselfish love, and that these are not equal.

Scientists, engineers, and science fiction writers all have personal psychological needs, including those that may expressed in the belief that we are alone, or in the belief that we are not. These needs are a characteristic of being human, and unavoidable, even when one is trying as hard as possible to be objective. The best that can be hoped for is to display our logical reasoning, along with our hopes, fears, and motivations.

Personally, I fear Berzerkers, though I am fairly sure that in about 50 to 100 years, we will be able to handle them. For me, an even greater fear is based on our own historical record -- I fear that contact with a superior civilization would destroy us, even with their best intentions. On the other hand, it certainly would be nice to have the guidance of an elder race, one wise enough to build us up without destroying us, one wise enough to help us mature without destroying ourselves.

As far as feeling that our being alone might be interpreted as a Sisyphean cosmic joke, I can't deny anyone choosing that interpretation, nor can I deny someone else's interpretation (e.g. Tipler and Barrow especially) that our being alone instead makes us the God-cherished super-special

pinnacle of creation. Both positions are logically reasonable, but my point is that you get to choose one. Since it is experimentally impossible to distinguish between the two alternatives, it would be more reasonable to choose the one that has the more positive consequences. Given the problems so many individuals in our culture have with depression and low self-esteem (why else would Alternative Rock be so popular?), I'd say (at the risk of sounding Pollyannish) that if you can't know for sure, recognize the arbitrariness of your decision, but choose the belief that gives you joy, and not the one that fills you with despair.

Most space enthusiasts, especially the more technically adept ones such as Bob Zubrin, agree that some theoretically possible starship propulsion systems would be detectable many light years away. The problem seems to be one of concurrency -- we would need to be looking at that evidence when it arrives at our planet -- a highly improbable event if their civilization only lasts for a thousand years. This is an especially tricky guess since we have *NO* data points for how long a radio-using civilization will last. On the other hand, if we consider radio as a form of communication analogous to writing, then from the limited number of examples on Earth, at least two countries (China and Egypt) have used writing to support their national identity for five thousand years, and at least one organization (the Catholic Church) has maintained a strong centralized hierarchy for two thousand. But these timeframes are still minute in comparison to galactic time frames.

On the other hand, while nations fall, and people scatter, life is pretty tenacious. After we get off this planet and establish self-sustaining O'Neill colonies and terraform planets, what could possibly exterminate all of Terra's daughter biospheres? It would have to be big, mean, and nasty. And it would have to hit soon -- for in a thousand years (which is a cosmic nanosecond), it is entirely reasonable that we will have sent out hundreds, if not thousands of starships (otherwise, why the heck are we NSS members?). It is certainly probable that many starships may never arrive at their intended destinations, either because of internal or external mishaps. But is there anything that could possibly stop them all? Once they're leaving at relativistic light speeds, they will constitute a wave that, even if Earth and her daughters destroyed themselves after spawning, would echo throughout the galaxy for a million years. The same reasoning applies to any other spacefaring civilization. And while we can easily come up with scenarios that might wipe out any one species, we know of none that could wipe them all out. So the concurrency argument lacks an important factor in that it lacks universality.

Arecebo-class radio antennas could pick up only the carrier wave of "I love Lucy". But you can bet that if we picked up such an artificial signal from Space, we'd build another, much larger antennae with which to pick up the modulated signal. This is because of the inevitable characteristics of intelligent life have survival value in the real world, especially cautious curiosity and playful exploration.

The argument has been raised [by Kokh, reference above] that a conscientious civilization might have a sort of "Prime Directive" that would motivate them to steer clear of "G" type solar systems like our own. But given that nature

(human nature especially) is filled with predators, it is inconceivable that there would be no spacefaring predators. Perhaps some of the "enlightened" races could set up a "wild-game" preserve for humans, but could not the "game wardens" be bribed or overwhelmed? They would have to have the virtue and power of angels to resist the poachers (hmm, maybe there is something about this decade's preoccupation with aliens and angels). Perhaps the border is breached often enough to feed the rumor mills of the UFO and angel enthusiasts.

On the other hand, why an advanced predator would be interested in mutilating cattle or inseminating human females (while leaving the rest of the planet untouched) is beyond me. As an All American wrestler, I have known blood lust, and it might explain a thrill-seeking hunter's motivations, but domesticated cattle? That would be as much fun as pulling wings off of butterflies. Why not create a Jurassic Park and stalk some real game? The idea of alien abductions for DNA sampling is equally ludicrous. Artificial mosquitoes and/or fleas could get DNA samples of every person on this planet much faster and with a lot less fuss. For an advanced interstellar species to desire human females (or males) for sexual conquest is as ridiculous as humans having sex with insects. On the other hand, some perverted humans prefer to have sex with animals, so this could be a similar phenomenon. But wouldn't a Virtual Fog holodeck be a lot more satisfying, with a lot less risk? The only logical explanation would be that the "poachers" would be using the mutilations and abductions to serve another goal. I am struck by the juvenile immaturity that runs through the antics reported in the UFO stories. On a darker note, Dr. Scott Peck points out in *People of the Lie*, that one of the side-effects of evil is confusion, and the people experiencing so-called alien abductions are certainly bewildered and confused by it.

The Fermi Paradox does not say that interstellar visitors would leave relics. It is rather provincial to think that visitors would leave the high tech equivalent of graffiti in the hopes of "leaving a mark in the sands of time". It's nice to achieve immortality by achieving great accomplishments, or by raising wonderful children, but it's probably nicer to achieve immortality by not dying. Therefore, relic-leaving, graffiti, and other expressions of yearnings for immortality would not be a characteristic in any reasonably long-lived species -- which, if current technology advances as quickly as past trends indicate, will soon include us. Besides, why leave relics on the Moon when you're metabolizing the entire Sun?

Though the four fundamental forces of this universe favor the chemistry of water-dependent carbon-based life forms, there is no need to anthropomorphically assume that interstellar visitors would share our chemistry. However, based on our observations of life forms on Earth, it is reasonable to assume that at least one alien species depends on energy and matter to reproduce, survive, and think. And if they are a spacefaring species, they will need starships, and tools with which to build them. So they need energy, and any convenient star will do. If it only took one afternoon for Eric Drexler and Keith Henson to figure out how to move our Sun to the Far Edge Committee meeting (at the other side of the Milky Way), imagine what a technologically advanced species could do!

Some have claimed that mature, long-living races would be following Maslow's hierarchy and therefore no longer be interested in interstellar imperialism. However, there is no mathematical imperative inherent in the structure of the universe that would force an interstellar culture to adopt Maslow's hierarchy, possibly because it suffers from some philosophical difficulties. Therefore, it is highly likely that at least one alien species would not follow it -- hence, they would have been at our doorstep a long time ago.

It has been argued [by Kokh, reference above] that the Great Silence can be explained on economic terms -- i.e. it is much, much cheaper to listen than to broadcast. This may be true, but for civilizations that metabolize the energy of many suns, whose offspring are spreading in unknown and unpredictable directions, broadcasting over millennia would be the only way it could guarantee a light-year distant link with the home world. Again, it is quite reasonable that many home worlds might choose to send only narrow beams, but there is no reason why all of them would do so. In addition, it can be argued that since most of the great movements on this planet were sparked not by economics, but by the birth of an idea (e.g. the banning of slavery, the Master race, representative democracy, communism), economics may nudge but it will not dictate the behavior of a spacefaring civilization. Goodness knows, 99% of the people in the space activist community are not motivated by money, but by a dream.

Galactic topography [per Kokh] will certainly result in uneven intragalactic expansion, and backwater pockets will certainly exist for a while. However, as the Terran biosphere amply demonstrates after every natural or man-made disaster, life fills every niche as soon as possible. As members of the National Space Society, we are consciously working toward that goal, with Space being a rather big niche. It is inconceivable that all intelligent, tool-using life-forms would be incapable of doing the same. If it is, then why are we bothering? Perhaps we are a young, brash species that hasn't come to terms with the word "impossible."

A more disturbing thought is that the "childbearing years" of a civilization are a characteristic of cultural expansion, and that the socioeconomic, technological, and political capabilities that enable starships also set the stage for the death of the cradle world. What would be the mechanisms that drive such a self-destructive procreative act? I don't think there are any. In fact, the Turner Thesis (which Bob Zubrin has applied with great success toward the settling of Mars) looks at the histories of the Mediterranean and of the New World to show that it is precisely that expansion of a nation into frontiers which invigorates those who stay behind (not to mention the opportunities it provides for those who go).

One of the problems with understanding too much about molecular technology is that it makes most science fiction seem like 1940s Buck Rogers -- hopelessly outdated. For example, ideas of "Seed and Spore Arks" equipped with robo-wombs and robo-parents in mini-biospheres [Kokh] seem quaint when we consider the capabilities of advanced cellular manipulation: Why would we need plants and animals if we can recharge our mitochondrial ATP directly with electricity? We wouldn't need to eat or breath oxygen. By reinforcing our

skin cells with a titanium-diamonoid matrix, we wouldn't need to worry about hard vacuum, and with appropriate error-checking and molecular repair, even cosmic radiation would no longer be a concern. High energy applications could be supplied at high efficiencies by antimatter, while low-energy needs might be supplied by spreading wings to collect starlight photons. Like the spice-mutated pilots in Herbert's *Dune*, such spacefaring individuals may not look human, but not only could they be our descendants, but us, in our augmented bodies. At present rates of technological progress, all you have to do is make it to the point where technology pushes life expectancy forward faster than time passes.

The Fermi Paradox says that there is *no* reason that at least one interstellar species would not take over and settle *every* star in the Milky Way. So while everything we know indicates that they should be here, they obviously are not. So that's the paradox. In his famous *Cosmos* series, Carl Sagan put forward one cautionary possibility that resolves it. Focusing on nuclear weapons, he essentially claimed that advanced tools automatically cause the self-destruction of the species.

Another, less well known but more optimistic possibility is Vernor Vinge's technological Singularity, popularized in his novel *Marooned in Real Time*. Vinge envisions a point at which technology hyper-accelerates to the point that people become transhuman and then quickly transcend this universe. This is a likely candidate for the Great Silence because technology always builds on itself. Certainly, technology advances in fits and starts. It can also be misused, and it could be probable that many civilizations vaporize themselves to oblivion in a wide variety of ways just before reaching The Singularity. But in either case, they are out of the picture considerably before they leave their star, and all the arguments of rare concurrency in a huge and empty universe become valid. Even if an alien species did launch starships, technology would continue to be developed within these starships (if they are at all viable), and they too would soon follow the cradle world into transcendence. But again, these are just reasonable predictions -- we have no proof, just short (50 year) trends and conspicuous holes in our knowledge.

At this point, the lack of the evidence for aliens indicates that we are alone, with no friendly elder race to care for us. In that case, the few hundred activists in NSS, SFF, SSI, and similar groups currently hold the responsibility for the destiny of the human race and Terra's biosphere. We alone. I don't know if the existence of star-faring species would be a comfort or not. The image of Berzerkers in the dark, homing in our radio waves, simmers under my primate instincts -- Be prepared for fight or flight, but *get out of the cradle!* <TTF>

[Tihamer "Tee" Toth-Fejel Founder of the Ann Arbor Space Society, a chapter of the NSS. Editor, *The Assembler*, Molecular Manufacturing Shortcut Group, a non-regional chapter of the NSS. Tihamer (trouble with a capitol "Tee") can be reached at (313) 662-4741 (h) or at <tff@rc.net> ]

## Continuing the Discussion

by Peter Kokh, Editor of MMM

I am delighted that “T” has responded to my remarks, and he has invited me to continue this friendly discussion.

It is a commonplace that we are a predatory species, and embedded in that belief is a certain amount of emergent self-blame for the slow and seemingly inexorable degradation of our biosphere and its many complex ecosystems as a result of our well-intended but impatiently intense search for a better life, individually, communally, nationally, etc.

Regrettable as the ongoing cascade of planetary changes surely are, we have become the dominant species on this planet not by being predatory, but by being omnivorous. We *can* eat anything and *will* eat everything. We are simply capable of pressing into our advantage everything else that shares our world, animate and inanimate alike. *We are the Borg* of our own cradle planet, so to speak.

Ominous in its implications, but not at all with evil intent. In a way, the diverse impacts we have the species with which we share our biosphere flow naturally from our dominance, and *even a greatly enhanced sense of stewardship may not be enough* to prevent some of the consequences which we regret. Throughout terrestrial biological history, species that could not adapt to changing conditions have become extinct. They were too set in their ways, so to speak, too specialized, retaining insufficient generalization. To include the obvious here are all those species at the opposite pole from omnivorousness, those whose sole food consists of one species: pandas, for example. They have backed themselves into their own corner. Some of these species, those with enough charm and visible appeal, will find themselves preserved by *our* own intense efforts, not by *their* own.

***The biosphere is in the process of transforming itself into a post-human one.*** Those that can thrive in the presence of mankind, his farms, suburbs, and cities, etc. will do so. Those that can't make the adjustment in life style for the better will die out, despite our best efforts, which will only delay the inevitable, oftentimes at a cost that ultimately cannot be justified. These are sure to be controversial remarks. “Maximum Biodiversity” is a most worthy goal. But we must be aware that there are real limits to the extent this goal can be realized.

Yes, the terrestrial biosphere could be much more diverse if we suddenly disappeared. But ***without us, Gaia cannot reproduce itself off planet.*** If we are the means of this reproduction, of setting up offshoot biospheres off planet both for ourselves and as many of our companion species as we can practically incorporate, then the side effects of our emerging ascendancy and its technological and ecological side effects must be accepted as the price that must be paid. In other words,

our emerging ascendancy on Earth, even if it means a major thinning of the number and variety of companion species, must be seen as the Greater Good for Earth Life {Gaia} in general.

On the space frontier, where we will live immediately “downwind” and “downstream” of ourselves, environmental thoughtlessness will be very rare - we will be responsible or we

will perish - *sooner rather than later*. So I would reject the idea that expansion into space automatically means that the “ugly human” traits of our current adolescence will inevitably accompany us. *Space will be too unforgiving a frontier to permit such nonsense*,

Going into space will thus force a certain overdue maturity upon us, a responsible adulthood, if you will. I see this as happening for *any* emergent technological species. We either grow up or snuff ourselves out. That is why I find the proposition that “all” spacefaring species *may follow* the “Prime Directive” of respect for other pre-emergent species a more likely scenario than Toth-Fejel's assertion that at least some spacefaring species may be “predatory”.

The idea that this sets up “Preserves” and that their will be posted-guardians that can be bribed seems to imply that more than three races (including the inferior one) will cross time-space paths in this enormous universe in the same time frame. Concurrence (visitors finding another species at an “interesting” point of its emergence just when they happen to visit) may be rare enough. Multiple concurrences will be proportionally more rare.

I agree with “T” that human ambitions are clearly interstellar. But while we dream our Ad Astra dreams, until we either ourselves achieve starflight or detect the signatures of interstellar drives in use nearby presumably by other species (as Bob Zubrin has shown is possible), *we have no proof that the enormous engineering challenges needed to make such theoretically possible propulsions possible, can indeed be overcome. All species living on partially cloudy planets will yearn for the stars.* Some may escape their immediate solar neighborhoods, *just*. Will all do so? Will all continue to make breakthrough after breakthrough? Will all spacefaring cultures remain vital through the millions of years necessary to settle the galaxy? If none succeeds, that will prove only that the technical engineering problems are too great, not that there are no other species, not that we are alone. For from their point of view, since we are still in our cradle, we don't exist either on their galactic maps, color-coded for degrees of feature significance. And then there is this curious implied standard that galaxy-wide presence is a mark of having made it. What is one galaxy in a universe that has more galaxies than our own galaxy has stars?

Tihamer finds the idea of leaving relics is a quaint and provincial expression of the need for immortality. That is not at all the motivation that I would attribute to it. Visitors might leave relics, not of themselves, but rather preserved snapshots of our own biosphere and environment at the time of the visit, sort of a “present” to any intelligent race that might someday arise (assuming they had come at some significantly earlier moment in our time flow), sort of a “Cheshire Cat Smile” from elder cousins (would they not share what has long been called “the creatural condition”?). As such *it would be their way of enriching our own heritage out of its own resources in a way that would reveal nothing beyond the technologies of preservation and presentation involved, and thereby avoid any superior-inferior culture clash.*

When all is said and done, we are in complete agreement that it is imperative that we break out of our cradle, that we establish viable and survivable pockets of humanity



and accompanying life, that we insure the survival of our species against any and all terrestrial doomsday scenarios. At the same time, we must never forget that we are mortal creatures. A nearby star could supernova and fry us all even if we've tamed our own system, its errant asteroids, and our own adolescent environmental carelessness.

As for molecular technology, I am glad it is being pursued. All options should be. Nonetheless, older foggie that I am (than "T"), I see too many nightmare Chernobyls down that path. Perhaps I am wrong. Yet it is a brave new world whose dawn I personally do not anticipate with eagerness. There are limits to everyone's vision, and my own visions of the future may be quaintly blind in this respect. I can only describe what I can visualize and it is up to others to take it or leave it. I have an all-illustrated book titled "Yesterday's Visions of Today" which amply illustrates that it is the fate of any glimpse of the future, however carefully and thoughtfully composed, will end up "quaint" and "curious" in comparison to eventual reality.

*Consider the source. If it's human, take it with a grain of salt.* MMM hopes not to describe the future in detailed accuracy, but rather to *inspire readers to work* towards a future that is even more expansive and rich than our own present, a future in which the human "world" includes more than just our home world set in it's own no-outlet "gravity valley", a more cosmic world which accepts no set territorial limits. <MMM>



## **Concept Papers by SLuGS**

[Installment III: Concept Papers Prepared for the Space Exploration Initiative (SEI) and the Stafford Commission by SLuGS - Seattle Lunar Group Studies - Reprinted with permission.]

### **Autonomous Free Flying Robots for Zero-G Space Infrastructures**

(Stafford) by Joseph P. Hopkins, Jr.

A series of robots that are autonomous and free flying need to be developed to perform tasks external to zero-g space structures. These robots would be targeted to perform repetitive, hazardous, and simplistic tasks. On manned missions they would also serve as 'gofers' and assistants for astronauts performing EVA tasks.

These robots would be comprised of cameras, manipulators, sensors, a communications package, a propulsion/power system, and an on-board expert system computer. The robots will require a software architecture that is a hybrid permitting full autonomy or teleoperation. Computers that are inside the structure or Earthbased would have scheduling, simulation, and teleoperation programs that would support the dispersed robotic systems.

These robot systems would increase crew productivity by reducing the amount of time required for EVA on routine and frequently occurring tasks. The robots can perform tasks that are day-to-day, predictable, well-defined, repetitive housekeeping chores. These tasks, examples which include inspecting the exterior for damage or wear and removing contamination from exterior surfaces, do not represent an

optimal use of crew time when performed through EVA. Also they would perform hazardous functions thereby reducing risks to the crew.

Another set of routine tasks within the capability of these robots is experiment support. Many instruments used in space experiments will require routine servicing such as replenishing consumables, replacing focal plane instruments, changing film canisters or optical filters, and placing or retrieving material samples. While similar in required capability to the housekeeping tasks, these tasks are not as basic to robot services because they are not as routine. That is; the task requirements will change from experiment to experiment and the planning and robot programming for the task will probably have to be done on-station. Therefore, savings in crew time is not as great as for automating housekeeping functions. These tasks will also depend on the existence of task-oriented planning software for the robots.

In addition to performing critical and routine tasks, robots may also serve as crew assistants. A mature robot could be used as an assistant to a human crew member in addition to performing tasks autonomously. These capabilities could reduce the frequency or duration of EVA or reduce the number of crew members needed for some EVA tasks. One of the simpler crew support applications possible with a rudimentary robot system, is to use a robot to provide a remote view of a potential EVA site. The Space Shuttle has used a TV camera mounted on the remote manipulator for a similar application.

Development of these robots could be undertaken on low Earth orbit space stations, where when successfully deployed they would go a long way toward contributing to productivity and safety. On Mars bound missions robots would off-load many routine EVA functions. Robot programming languages, sensors, manipulator end-effectors, the operator/system interface, and autonomous logic systems are among some of the areas in which advances must be made. The resulting technologies would find many Earth bound applications in such diverse fields as: industry, hospitals, the home, agriculture, hazardous materials handling and the military.

<SLuGS>

### **Another Use for a "Space Elevator"**

(Stafford) by Stan Love

A popular concept for a device that can easily loft great quantities of material from the Earth's surface to orbit is a "space elevator," essentially a cable linking a point in geosynchronous orbit with a point on the Earth's equator. Cargo can be shuttled up and down a space elevator much more simply and safely than by using chemical rockets. Such a system is far beyond current materials and engineering capabilities, but has nonetheless received much attention in popular literature.

In the classic setup, the weight of the cable is counterbalanced by a large mass suspended outward of geosynchronous orbit. This mass, forced to move at greater than orbital velocity, exerts an outward force balancing the inward force of gravity on the parts of the cable that are below geosynchronous orbit. A superior design, however, might be to simply extend the cable outward until its own mass balances on both sides of geosynchronous orbit. The total length of the cable becomes

on the order of 145,000 km, and the entire construction can then act as a very large rotating tether. A payload attached to the cable by a ring and pushed outward from geosynch altitude will pick up speed as it slides outward, finally leaving the end of the cable at a velocity of about 11 km/s relative to the center of the Earth. Since escape speed from the Earth is only 2.3 km/s at that distance, packages could be sent anywhere in the inner solar system without the use of propellant, simply by pushing them down the cable at the right time.

Given the technology necessary to build a space elevator, this concept could be realized with little additional effort. Care would have to be taken to let the cable "relax" after each load, since accelerating a payload might cause it to bow backwards, and oscillate for some time after the payload departed. The effects of tides (this cable would reach almost halfway to the Moon, and be in a plane offset by 23 to 30 ° from the Moon's orbital plane) on the cable would also have to be taken into account. <SLUGS>

## ***Magnetic Solar Wind Collector***

(Stafford) by Stan Love

The idea of using magnetic fields to direct the flow of space plasmas has had considerable attention in popular literature, particularly in connection with the Bussard ramjet, a concept which uses an enormous magnetic field to "scoop" the interstellar medium into a fusion motor to provide a continuous source of fuel for a missions to other stars. A version of this idea could be used to provide a source of hydrogen for use on the Moon. The Moon does not possess a ready supply of this vital element.

The flux of solar wind particles through the Moon's cross-sectional area is roughly 5 grams per second. These particles are primarily (about 80 percent by mass) protons and electrons, but there is also a smaller population of the nuclei of helium, carbon, oxygen, nitrogen, and other elements.

Since all the particles in the solar wind are charged, their flight can be deflected with a magnetic field. A field capable of channeling the solar wind around an area 700 km in diameter is probably within reach of current technology (Andrews, D. G. and Zubrin, R. M., "Progress in Magnetic Sails," AIAA Paper 90-2367,1990). The diameter of the Moon is only a factor of 5 larger than this.

Channeling the solar wind material onto some sort of collector, and recovering it from that collector would be a tough, but probably not insurmountable, problem. If the magnetic field is generated with a superconducting loop, power will be required only to set up the field, but not to maintain it. It may take several smaller magnetic fields to focus the particles trapped in the main field onto the collection surface.

This system, operating at perfect efficiency, could conceivably provide a lunar base with as much as 300 kilograms of hydrogen per day, enough to meet the needs of even a very wasteful colony. Although the efficiency of a real system would doubtless be much lower than unity, hydrogen is so scarce on the Moon and has so many applications in space travel (notably as a fuel cell reactant, a propellant, and for water) that it might well be worth the effort of constructing such a system to capture it.

<SLUGS>

## ***Using Structural Steel on the Moon***

(Stafford) by Hugh Kelso, Bob Lilly,  
Mike Anderson, David Graham, Robert Taylor,  
Kent Karnofski, Joe Hopkins, Stan Love

It is widely accepted that large lunar bases will be built using local materials. Aluminum, steel, titanium, concrete (lunarcrete) and glass/glass composites have all been proposed as possible primary structural materials. Steel is the better choice for reasons of superior durability and availability. Steel and aluminum are easier materials to work with than the others and it is much easier to manufacture usable billets. In comparison with aluminum, steel is the better material choice in terms of overall strength, ease of production using well-established technologies, and reduced energy requirements.

Aluminum alloys have received considerable attention in lunar base designs, which may be a carry-over from the orientation aerospace designers have had in designing lightweight spacecraft/aircraft. On the Moon, however, the weight of structures is not a primary design consideration. Other factors, such as abundance of material, durability, and ease of refining, manufacture, erection and construction are more important.

Steel could be made using iron existing in the lunar regolith. In order to create lunar steel, it may be necessary to import certain trace elements, such as carbon and nickel. The quantities required will be only a fraction of the total mass of steel produced: 0.55 percent for ASTM A 36.

Steel is the material of choice for large structures on Earth. The technologies for producing and building with steel are widely known, and the building codes for it are well established. Steel is readily produced in standard structural shapes. By avoiding the expense of creating new materials and learning new technologies, costs can be reduced.

Thermal expansion will play an important role in construction. During the lunar day the temperature reaches 110° C and at night drops to -170° C. Material expansion coefficients must be considered, particularly if different structural materials are to be used in the same structure. At the very minimum, construction must be carried out at a relatively constant temperature, perhaps under some sort of shade awning. The thermal expansion rates of steel and lunarcrete are very close, an important advantage considering the benefits of using lunarcrete in conjunction with metal structural elements.

How the structural material responds to the frequent internal pressure variations must be considered. The operation of air locks and atmosphere recycling systems may cause pressure cycling in the structure. Steel has an excellent fatigue resistance shared by few other metals. Specifically, for strain less than half the yield strength, an infinite number of load cycles may occur without any fatigue effect. The fatigue resistance of steel helps to insure structural integrity for longer periods of time. A lunar base constructed of steel could be expected to last decades longer than one built of aluminum.

The amount of energy required to produce the structural materials must also be considered. Reduction of iron from oxide requires 1/6 the energy per unit mass that is required to reduce aluminum. Also, iron oxide can be reduced using simple heat treatment, whereas the breakdown of

aluminum oxide requires a more complicated and less efficient electrolysis process.

Steel can also be used for secondary structural purposes: Partition assemblies, hardware needs, fasteners (screws, bolts, etc.). Once basic processing and mining/refining technologies are set up to produce steel, various tooling machinery can be brought up to expand the variety of items manufactured on the Moon. <SLuGS>

## ***Storing Energy for Lunar Nighttime Use***

(Stafford) by Dean Calahan

Night phase energy supply is a critical element of Lunar Base design concepts. Two approaches are onsite production and offsite production and transmission (for example, Solar Power Satellite). Of onsite choices, storage of day phase solar heat for power conversion at night has received some attention, but a complete analysis of the opportunities available has not been accomplished. This submission proposes helping to fill that gap in knowledge by examining the opportunities available from storing heat in vaults of regolith or regolith-derived materials. This method will be called **DPES for Day Phase Enthalpy Storage**.

**DESCRIPTION:** During Lunar day, focused Solar radiation heats a large mass of high-enthalpy powder contained in an insulated vault. At night, a working gas is pumped through the vault and cycled through a heat engine, generating power for local use. The waste heat must be dumped, either radiatively or into a heat sink of some kind, perhaps a vault of regolith cooled radiatively during day phase. Possibly the heat could be dumped into the local regolith environment.

The enthalpy storage mass (regolith or locally manufactured material) and working gas (oxygen) are produced locally. In addition some low-tech parts might also be manufactured at the base. The heat engine and difficult-to-make parts (for example a liquid-drop radiator) might have to be supplied from Earth.

**PAYOFF/VALUE:** DPES, built primarily from locally available materials, avoids the problem of shipping most of the mass of the energy storage/generation facility from the surface of Earth. For a first- or second- generation base, the nuclear, fuel-cell, and SPS options require most or all of their mass to be supplied from Earth. A power supply system constructed locally increases the self-sufficiency and ease-of-expansion of a Lunar base.

**ENABLING TECHNOLOGIES:** Lunar construction techniques must be up to the job of building sealed, insulated vaults of regolith. Techniques of radiating or sinking the waste heat must be developed. <SLuGS>

## ***SunWatch Satellites***

(Stafford) by Stan Love

As manned missions in the solar system become commonplace, it may become necessary to have good and continuous knowledge of the conditions on the surface of the

sun, particularly with regard to solar flares. The sun rotates once every 25 days, bringing different areas into view constantly, and violent changes can occur on the surface in minutes or hours. The charged particle emissions of flares and other active regions on the sun can change unpredictably, and missions and installations without superb radiation shielding will benefit greatly from current "weather reports" on solar activity. Each separate crew could obtain this information by training telescopes on the sun and keeping a constant watch on it. A more elegant solution to the problem might be to deploy a small number of solar observatories in orbit about the sun.

A solar "weather satellite" network could be achieved with only two small telescopes, placed in orbit about the sun, 120° ahead of and behind the Earth in its orbit. The change in velocity necessary to emplace them would be on the order of 1 km/s, once escape from Earth is achieved. Since halo orbits of the sort required here are not stable, the observatories would require a small amount of station keeping propellant, and periodic refueling. Every point on the Sun could be monitored by at least one satellite or by telescopes on the Earth, and the Earth would always be in direct line-of-sight communication with each satellite. Adding one more satellite and spacing them by 90° would give redundant coverage of the entire sun by at least two observatories. The current conditions on the sun, or at least warnings of dangerous flares, could be then compiled at Earth and transmitted, either from Earth or from one of the observatories, to spacecraft and space stations anywhere in the inner solar system. <SLuGS>

## ***Variety in Biological Life-Support Systems***

(Stafford) by Stan Love

A great deal of work has been done recently in the field of biological life-support systems for space applications. Such systems are advantageous in that they almost perfectly recycle their air, water, and solid wastes, producing fresh food at the same time.

An interesting feature of currently-envisioned biological life-support systems is that they contain plant species for producing food and for recycling water, air, and solid wastes which fill the needs of the crew with very little room to spare. A typical design features about a dozen plant species, with just sufficient mass to keep the system functioning. If even one species were to fail in some way, such as via disease, pest, or genetic damage, the entire ecosystem could collapse, perhaps killing the crew if replacements were not readily available.

This danger can be minimized by carefully choosing the species and the seeds used to grow them, but biological systems are notorious for evading even the most careful controls. Worse still, if all biological life-support systems in use in many habitats all use the same species, a plague or pest could infect one, easily spreading to the others and perhaps destroying a large fraction of the life-support systems in use everywhere!

This problem poses an interesting dilemma, and one that will have to be resolved before biological life-support systems can find widespread use in space. A system that

barely fulfills the needs of the crew is dangerously unstable against factors even as trivial and commonplace as a bad harvest. On the other hand, stability in biological systems is a function partly of the size of the system and more strongly on the diversity of species in that system.

Adding size, or, more importantly, a variety of species requires additional mass, which is the deciding factor for most space applications. Presumably, the solution to the problem will lie in a sort of compromise. Biological life-support systems could be equipped with a few carefully-chosen standard species as the baseline, to which are added a number of additional species which are capable of performing the job of life-support if the standards fail. This tactic would have the additional advantage of providing a wider variety of food for the astronauts, who may become bored with eating the same dozen plants for years at a time.

<SLuGS>

=====  
**Again, MMM wishes to thank David Graham for permission to reprint these Concept Papers.**  
 =====

**RESPONSE TO THE SEI & STAFFORD SUBMISSIONS**

In January of 1991, AIAA began mailing out letters of appreciation to contributors. The letters noted that the final assessment report included the best 500 ideas of all the ideas submitted. Most of the SLuGS concepts were included in the final report.

The AIAA report highlighted less than two dozen of the 500 total ideas as having "exceptional merit." Five of the SLuGS concepts were so recognized. We are, of course, very pleased and honored by this recognition.

The concepts granted "exceptional merit" recognition are as follows:

**Magsail Asteroid Survey Missions**

by Stan Love

**Magsail Stabilization of Lagrange Point Structures**

by Stan Love

**Magsail Mars Missions** by Stan Love

**Lunar Base Construction by Regolith Tunneling**

by David Graham

Some of the SLuGS concepts involved application of traditional structural engineering concepts to what has been heretofore an exclusive domain of aerospace engineering and thought. It is difficult to present such divergent methodologies in one page concept papers. The SLuGS team feels that some of the ideas were "undervalued" as a result.

For example, the evaluators gave the "Regolith Tunneling" concept exceptional merit status while concluding that the dependent technology, "Sheet Piled Excavations," was not practical on the Moon. The team feels that the sheet pile concepts solve a host of very serious problems that must be overcome before serious construction of permanent lunar bases can begin. Therefore, major papers extolling these and related structural engineering concepts were presented by SLuGS at the International Astronautical Federation congress in the fall of 1991 and the Third International Conference (Denver, 1992) on Engineering, Construction, & Operations in Space sponsored by the American Society of Civil Engineers. <SLuGS>

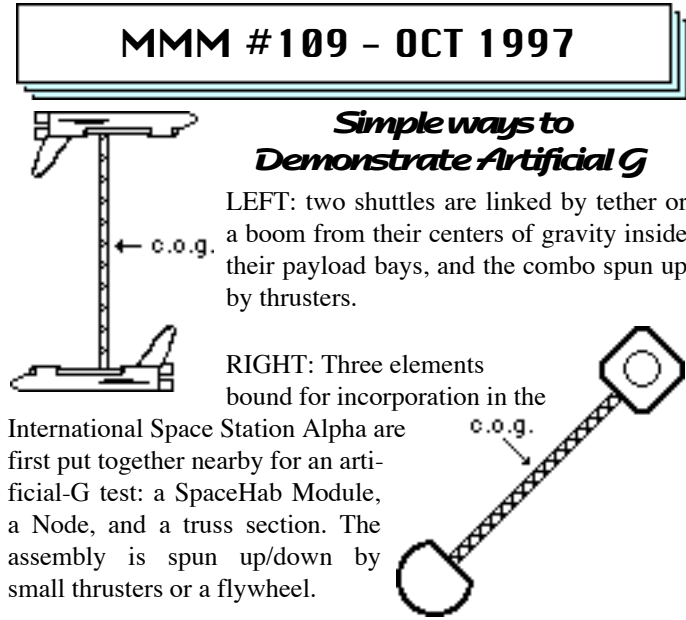

**IN FOCUS**

**We need an "X-Prize" for In-Orbit Artificial Gravity**

Commentary by Peter Kokh

When the Reagan government committed in '84 to building a Space Station, perhaps many of us conjured up the vision of Von Braun's "wheel" as depicted so well in the epic Kubrick/Clarke film; "2001: A Space Odyssey". Alas, neither NASA nor its contract-seeking aerospace has ever entertained the idea of realizing an artificial gravity platform in space. No allusion is ever made to Von Braun's dream, and the whole idea lies buried in an unmentioned limbo in an unspoken partners conspiracy of silence. Instead, throughout the long rocky road to Freedom, Fred, Fried, er ... ISSA, what we see instead is the pursuit of validating the medical-physiological-mental feasibility of year(s)-long duration "micro"-gravity to demonstrate the possibility of an eventual exploratory science picnic strike at Mars.

NASA has not been without opportunity to experiment with artificial gravity. All it takes is two shuttles or two modules or other roughly comparable masses co-rotating around a common center of gravity via adjoined tether. But we suggest that there is a reason, a rather insidious one from our own shared point of view as would be settlers of the solar system, why we have seen no such efforts, not even so much as official paper studies (!) to date. The reason is this: demonstrating the engineering and physiological feasibility and validity of artificial gravity would be tantamount to a storming of the Bastille, to the sudden realization that mankind might be on the verge of Cradlebreak! For with artificial gravity, we could travel to and from Mars and points more distant with relative ease, arriving with the strength necessary to tackle the scouting, the exploration, the experimentation, the outpost building - whatever - upon reaching our destination without having to waste precious time in bed rest reacclimatizing ourselves to gravity.

# Luna City Streets

Artificial Gravity opens the way for O'Neill type construction shacks, Bernal Spheres, Torus settlements and giant Sunflower worldlets. It would open the way to serious industry in space, to space settlement. Rotating habitats would allow asteroid miners as well to work healthfully, safely, productively, and be able to come home, if and when they so decided. Abracadabra, artificial gravity would open the Solar System at large as a humanizable domain. For the government, wanting to keep the space program "tamed and domesticated", innocuously contained within Earth-orbit "fringe-space", the potential financial commitment such a Cradle-breakout technology might encourage is sure to send cryogenic chills down the spines of any public official, not just the grim dream-reapers of the Office of Management and Budget.

Whether the infamous Roswell incident involves a government conspiracy or not, pales into insignificance long-term with the virtual conspiracy against even basic and rudimentary experimentation with artificial gravity.

*As much as we need Cheap Access to Space, as much as we need space nuclear propulsion, nothing stands to blow the lid off of the limits to human dreams like the realization of artificial gravity.*

We ain't going anywhere without it, not beyond the Moon in any significant way. Yes, we may do a self-limiting Mars sortie or two without it, but we'll get no further than that before bogging to a whimpering halt, reaching an invisible, unnamed, unidentified ceiling the public will soon accept.

Congress would no more let NASA doodle with rotating environments than it will let the Agency plan a lunar outpost or Mars expedition. Our manned aspirations have to be kept in check, satisfied with more affordable low Earth orbital tricks and trivia.

*How do we make an end run around this conspiracy?* The answer is clear. *We must encourage commercial demonstration of artificial gravity.* After all, even in Earth-fringe space, the ultimate economic bonanza stands to come from Tourism, and orbitals offering artificial gravity, of whatever level, will be much more popular than those that do not.

Meanwhile, there is strong enthusiasm among space-activists and government station supporters alike for allowing commercial activity at Alpha, much as the Space Frontier Foundation's if-you-can't-beat-'em-join-'em "Alpha Town" proposal has outlined. Such an Open Station policy might see the incorporation of commercially financed and operated laboratories, habitats, even compact picture studios and hotel modules in and around Alpha. Here too there is room for an independent coorbital manned rotating facility flying in formation with Alpha. Or, such a facility could be put up in its own, perhaps more equatorial orbit, serving commercially run industrial laboratories, tourism, or both.

Instead of leaving such developments to chance, however, space activists ought to *begin now to brainstorm how we could put together an attractive enough "X-prize" purse* to ensure that the realization of the first such facility comes *sooner rather than latter*. The stakes are high. The demonstration of physiologically acceptable artificial gravity stands to blow the lid off human aspirations, which media Science Fiction popularity notwithstanding, is at an effectively contraceptive low.

<PK>

by Peter Kokh [Your editor has been trying to limit the amount of personal original writing in recent issues in an effort to free up more time for putting together ISDC '98 Milwaukee. However, in thanks for your patience, here is some fresh vintage MMM.]

## Foreword

[NOTE: In MMM #52 FEB '92 p. 2 "Xities" we introduced the term "Xity" (to be pronounced KSIH ty, *not* EX ity). "Beyond-the-cradle off-Earth settlements ("Xities") will be fundamentally different from the familiar Biosphere-"I"-coddled "cities" that have arisen over the ages to thrive within the given generous maternal biosphere that we have largely taken for granted. Elsewhere within our solar system, each xity must *provide, nourish, and maintain a biosphere of its own*. Together with their mutual physical isolation by surrounding vacuum or unbreathable planetary atmospheres, this central fact has radical ramifications that must immediately transform space frontier xities into something cities never were."

In the same issue, the following article "XitiTech", pp. 3-5, we investigated a gamut of essential xity functions, some familiar but strongly redefined, others new and without precedent, and their demands upon the structure of xity bureaucracies, government, and politics.]

## The "Streets" of Luna City

We might define a street as an engineered passageway that connects buildings and other places where people, live, work, shop, play, and otherwise congregate. The earliest improvements in the construction of village and urban streets include paving and guttering.

In temperate climates and seasons, the structure of a street and access to it is simple. In more extreme climates and seasons, access to the street has encouraged the construction of buffering foyers, porches and awnings, and pedestrian arcades as well as the donning of gear more or less adequate to the inclemencies to be braved.

In more modern times, we have seen the emergence of climate controlled pedestrian malls everywhere where heat, cold, rain or snow might interfere with profit-generating shopping activities. And we've seen as well the downtown skywalks and underground galleries facilitating the busy bustle of vibrant snow belt downtowns, for example, those of Montreal and Minneapolis. Yet, despite such developments, it is still far more common for pedestrian and vehicular traffic to share rights of way.

In the thirties and forties, it was the common shared vision of the future that grade separations would universally replace in grade intersections. The expense of such a widespread infrastructure rebuilding, however, has limited this "stop-free" feature to all new "freeways" and "expressways" and scattered ultra-busy urban arterial intersections.

On streets of mixed use, the tendency has always been to maximize the amount of activity they enable. They are landscaped for maximum ambiance and attractiveness, and

lined with shops, eateries, service establishments and other amenities meant to encourage pedestrian and vehicle stop-ins.

**What might the streets of a future Luna City be like in the early era before the emergence of atmosphere-holding "mega-structures" such as crater domes, rille vaults and sealed lava tube courses?**

On the Moon we have inarguably extreme climate at all times: radiation-washed, micrometeorite-splashed hard vacuum with extreme though superficial temperature swings. A more benign "lee vacuum" is available at the price of a ramada\* or canopy over the trafficway. But for urban in-town purposes, all purpose pressurized climate-controlled shirt sleeve accessible pedestrian and traffic tubes will be as vital as the pressurized, climate-controlled shirt sleeve accessible habitats, labs, factories, shops, offices, etc. that they link in one inter-continuous mini-biospheric maze. In the course of everyday life, the urbane Lunan will don a spacesuit only during infrequent but seriously conducted "decompression drills". Even travel "abroad" to other settlements or outposts will be by hard-cocked vehicles, our airport jetways offering a very primitive foretaste.

\* [MMM # 37 JUL 90, p. 3 "Ramadas"]

**Size and Scale**

The humble ancestor of the lunar settlement street will be the outpost hallway as it first becomes suddenly transformed by the merchandising of dawn era made-on-Luna artifacts (wares, wears, or both). As the outpost is superseded or absorbed into a conscious settlement effort fueled by the availability of locally processed building materials and architectural components, such cramped passageways will be followed by much more spacious corridors handling both people and vehicles.

If we must build these long interconnecting cylinders to carry the everyday commercial and social intercourse of the lunar city, then surely it makes sense to build them on a generous scale, with ample radius to allow not only pedestrian and vehicular traffic, but serious agriculturally productive landscaping. This more directly interconnected city gridway-plex would then contain the lion's share of the city's shared biosphere and of its biomass-run climatic and regeneration flywheel.

[MMM # 51 DEC 91, p.p. 3-4 "Everfresh"]

[MMM # 57 JUL 92, p. 6 "Space Xity Biomass Ratios"]

[MMM # 64 APR 93, p. 9 "Towards Biosphere Mark III"]

[MMM # 96 JUN 96, p. 5 "A Green Security Blanket"]

As a reality check, however, it is important to add that such thoroughfare cylinder (sections) will not exceed in girth that maximum diameter which the settlement is currently able to fabricate. So the earliest settlement streets may be relatively more narrow, even as were those early streets of colonial Boston and Philadelphia that still survive. And perhaps that is as well, for the larger the volume to be pressurized, the more inert nitrogen the pioneers will need to import at high cost to the young settlement. The ideal is clear, however, and will serve as a driver of fabrication capacity.

Once more generously radiuses cylinder sections can

be built, these may be reserved for neighborhood-connecting cross-town arterials, and for commercial, industrial, and agricultural frontage roads. The narrower variety may continue to be produced for use as quieter, cozier traffic-restricted residential lanes. On the other hand, large enough cylinders could contain housing on their side terraces rather than just provide access to separately built modular housing, as illustrated below:

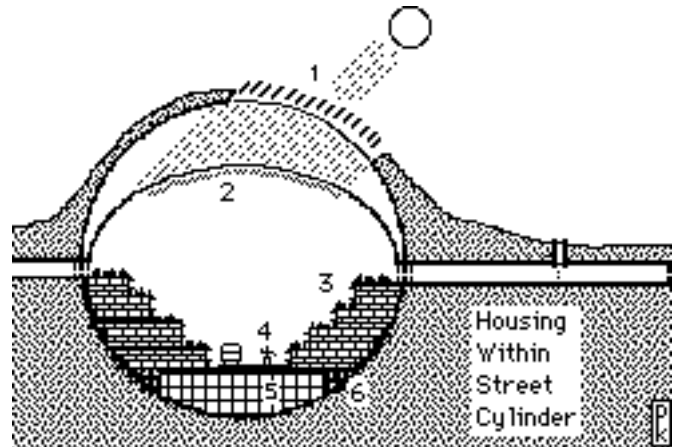

**THE RESIDENTIAL STREET ('HOOD') AS THE MODULE**

Cross-Section of cylindrical street module 40m x 700 m:  
 [1] shield louvers that let in the sunlight; [2] a suspended sky-blue diffusing "sky" - air pressure would be the same on both sides; [3] terraced residential housing with rooftop gardens; [4] the thoroughfare running the length of the (neighbor)'hood; [5] light industry and shopping, possibly offices and schools; [6] conduits for utilities.

Whatever their individual dimensions, the town street grid would present minimally clogging obstructions to an effective air circulation system. This could be set up to flow in neighborhood cellular loops\* starting with farms, flowing through residential areas, past commercial areas, through industrial zones and back into the farms in self-cleansing loops similar to the human heart-artery-vein-liver-lung loop. In contrast the aggregate of individual and conjoined homes, town homes, and apartments, of shops, offices, factories, schools etc. that we more commonly think of as "the city" will in large measure be interconnected only indirectly, via the streetplex.

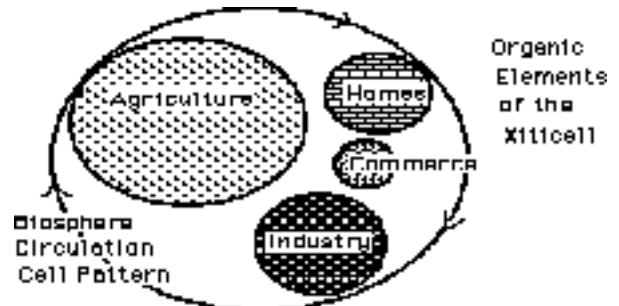

**BASIC ELEMENTS OF THE XITY FOUND IN XITICELLS**

A generous radius would allow pedestrian and mezzanines lined with alcove shops and cafés, tiered above general trafficways and transitways, still allowing relatively uninterrupted green space on the floor and terraces. To make that work, relatively continuous solar access strips will be built-in features of the ceiling, if not replaced by artificial but more

efficient gro-lighting. Nightspan lighting can make use of the solar access system (the actual lamps, and their heat, situated out-vac on the surface) or via artificial task and area spot-lighting.

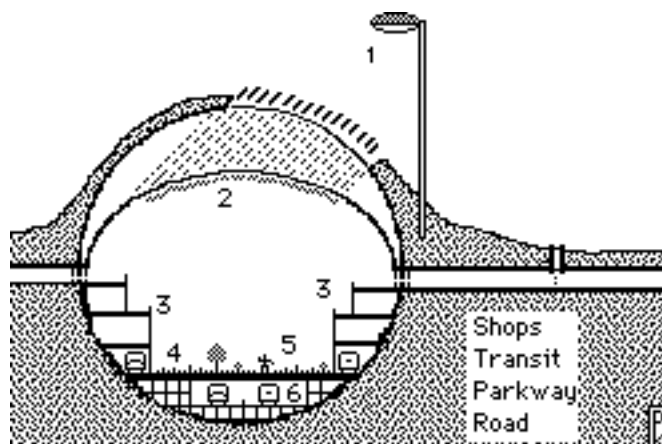

A COMMERCIAL STREET MODULE

Cross-Section of cylindrical street module 40m x 200 m: [1] shield louvers that let in the sunlight during dayspan, artificial light during nightspan; [2] a suspended sky-blue diffusing "sky"; [3] terraced shopping mall on either side; [4] transit buses; [5] pedestrian parkway strip; [6] 'underground' road, utility conduits.

The ceiling vaults of these multipurpose galleries might be sprayed a soft matte-white(-wash) finish of CaO (lime) or TiO<sub>2</sub> titanium dioxide, whichever is the more cheaply producible from local regolith soils. Such an eye-relieving vault or "firmament" might be given an Earth-like sky-blue cast by backlighting it through blue glass panes or lenses, whatever the actual light source, or by carefully diffused blue neon cove lighting, using solar wind gases. Attention paid to this artificial 'sky' will pay off.

Free side wall areas can be undecorated, self-decorated playing to the character of the locally made building material out of which the street cylinder is made, decorated with glass and/or ceramic mosaic creations, billboarded (point-of-sale signage especially) or covered with commissioned murals or code-governed graffiti or popular street art of various forms.

[ # 63 MAR 93, p. 6 "Color the Moon - Anything but Gray" ]

These important superficialities to the side, the complete organic function of the street demands it carry the major utility runs: electric power with intervalled junctions, communications cables, fresh air ventilation booster fans and ducts, heavy and light stale air "gutter ducts", fresh water supply and used water drains, the latter carefully segregated by source (e.g. toilet, bath and shower gray water, kitchen sink-garden-farm-landscape runoff)

[MMM # 40 NOV 91, p. 4 "Cloacal vs. Tritreme Plumbing" ]

As we've pointed out elsewhere, "somewhat clean" reserve water on route to further processing could be channeled through the agricultural or landscape terraces via open canals and/or trout-streams and thus do double duty, creating ambiance, allowing canoeing and row-boating, fish-watching, even trout-fishing. Here and there sidewater lagoons can serve as swimming ponds and water lily gardens, even a

lagoon for a city mascot pair of flamingos. Here and there, cascades and locks and waterfalls and arched pedestrian bridges can be worked into the scheme. Periodic dehumidifiers (humidity, not dryness, is expected to be the bane of man-made biospheres) can feed waterfalls and drinking fountains, draining into the fresh water supply lines.

[MMM # 67 JUL 93, p. 6 "Reservoirs" ]

### *The "Middoors"*

The beachhead science outpost will be simply a pressurized indoors up against the outlocks vacuum, the out-vac. Whenever it makes its appearance, in such a government outpost or in an early company mining town, the construction of the first spacious atrium solarium garden will introduce a new kind of space - a space external to individual quarters, lab modules, and other work- and function-dedicated pressurized places, yet still keeping out the life-quenching vacuum beyond the airlocks and the docking ports. What we have called the "middoors" will be born.

From this humble beginning, airy, spacious, verdant middoor spaces will grow to the point that they may eventually contain the greater part of the settlement's atmosphere and biomass. And with it, the hoped for "biospheric flywheel" will become much more of a reality.

It is within such spaces that longer, wider sight lines will appear, offering postcard views and vistas, to dull the edge of early day claustrophobia. The settlement will begin to take on the trappings of a little "world", a continuum of varying horizons. The effects on settler morale will be considerable.

"Indoor" spaces will be the more tightly climate controlled, allowed to vary only slightly from comfortable "room temperature" and humidity levels. In contrast, the middoors may be designed to swing freely, say from a late pre-sunset dayspan temperature that is tolerably warm and humid, to a late predawn nightspan temperature just enough above freezing not to harm the various plant-forms within. "Sunthly" "weather" patterns will add welcome variety and spice to day-in, day-out life.

That foremost conversation-making unpredictability of terrestrial weather, however, may be hard to program in. If temperate food plants are desired, perhaps an annual hard frost might be arranged one nightspan a year, as part of a partial cleansing freezing out of mounting atmospheric pollutants and impurities. It's a thought. And depending on ceiling heights of the street vaults, any gradual increase of humidity levels beyond a certain point might trigger mist-making condensations, say sometime after local sunset. At any rate, such middoor "weather changes" will help keep the populace healthfully invigorated, as well as supplied something innocuous to complain about. A fringe benefit will be the generation of a whole new cottage industry to create fashionable "outerwear".

[MMM # 5 MAY '87, "M is for Middoors" ]

[# 94 APR '96, p. 4 "Vac, Out-Vac, Lee Space, & Middoors" ]

[MMM # 96 JUN '96, p. 6 "Space Suit Aversion" ]

### *Intersection "Node" Modules*

**INTERSECTION NODES:** Try to imagine the current Mir complex without its pair of docking nodes, or the upcoming International Space Station Alpha without its module/docking

port connectors. A lot like a Tinkertoy set without its connectors - don't work! The so-called nodes may be the lesser part of a complex architectural construct, by volume, but they are what holds everything together.

A street grid without intersections would be limited to a monolinear layout with street cylinder modules laid end to end. This is not an unworkable system, and I can think of at least a couple of U.S. towns that are pretty much laid out along one *loong* street (Niagara WI, Bisbee AZ etc. and many more that do have cross streets but are overall strongly linear, compressed between hills and shoreline, along riverbanks, in narrow valleys, etc.). But a linear network, however well it might work for computers (or not), is not a good way to encourage maximum networking and economic and social interaction between humans.

**COMPLEX STRUCTURE:** In comparison to the street cylinder modules, intersection nodes have to perform functions which make them complex architectural and design challenges.

**Utility System interconnects:** if utilities (electric, fresh water, waste water, communications) are carried in service chases in the lower part of the street cylinder (beneath park and road surfaces, etc.) then somewhere in the intersection node module, their must be tributary / distributary connections and access provided to service and maintain them.

**Traffic Lane and Walk Exchanges:** this can be kept simple, as in yield/stop sign/traffic signal controlled common grade crossings that are the norm in most terrestrial cities. Or an infrastructure choice can be made early on to provide full or partial grade separation "interchanges", separation not only of crossing vehicular traffic, but of pedestrian from vehicular traffic. These are architectural and engineering challenges only, constrained, however, by available money on the one hand, and by radius and scale (allowable elbow room) on the other.

Next to the common grade crossing, the traffic circle is the simplest interchange solution, an option used with some success in many cities. A more generous floor plan radius with a high dome over a landscaped pocket park within the traffic circle, with grade separated pedestrian bridges is an example of what could be done.

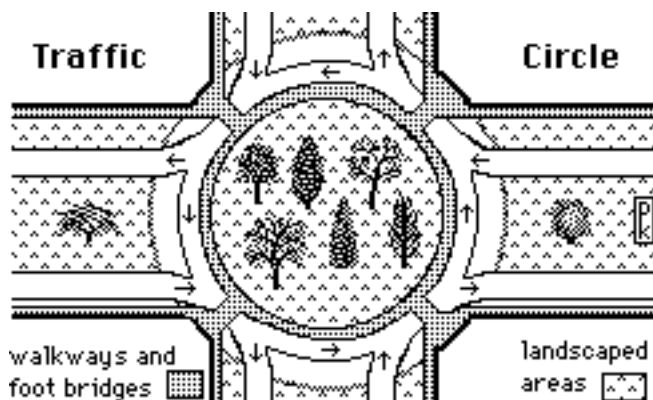

A tri-level grade separation (2 free through-flow separated levels, a 3rd signal controlled turn level, alternately allowing two sets of turns as below) would be desirable where traffic volume is greater.



**Pressurization Sphincters:** by all estimates of lunar

meteorite bombardment frequencies, (if you put an Earth-type city of 500,000 on the Moon's surface, you could expect one home per year to be "taken out" by depressurization from a meteorite strike, a loss rate far, far lower than most cities experience from fire) major depressurization strikes involving a direct hit on a street cylinder or intersection node should be very rare indeed, less than one a century in a smaller settlement. All the same, we could not afford one such strike to depressurize the entire "middoors" grid, and with it, the bulk of the settlement's biosphere. The only way to prevent this however is by emplacement of closable pressure doors or sphincters at intervals throughout the grid. Now these could be part of the intersection nodes, at the point where they connect with the (four) street cylinders, or they could be part of the street tubes themselves at each end, or, more economically, along the midpoint of each (halving the total number to be built and maintained). These are architectural and engineering questions. And quite a design challenge too, if it must be ready to deploy at anytime, even if unused for decades.

Perhaps there could be alternative systems in place to deal with minor "hull" breaches and leaks where air loss and air escape velocities are low. Any such system would be triggered either mechanically (power off fail-safe) or electronically by devices that sensed sudden pressure drop, or sudden increases in normal ventilating air current velocities. The salient estimate is of time needed to clear the area at risk.

**Sound Baffling:** If we don't want the settlement and its middoors street plex to be intolerably demoralizing over the long haul, architects and engineers will have to give full attention to sound baffling - something that is of much less concern in our terrestrial open-sky cities. The needed materials and construction methods should pose no problem. Whether bound -baffling features should be built into intersection nodes is a decision that will be made opportunistically, depending on overall design and other special features. Certainly, vegetation and trees would help.

**MODEL VARIATIONS:** there will be a number of intersection node modules, depending on the mix combination of intersecting street cylinder sizes and on whether or not extra height is allowed to enable grade separations for smoother traffic flow. One might expect intersections of four residential street tubes to differ quite a bit from one joining four commercial avenues, or a pair of each.

**USAGE DESIGN CHALLENGES:** Additional tweaking of designs is in order to meet expected use patterns: hosting town center institutions, offices, commercial shopping, entrepreneurs, cottage industry and arts and crafts markets and fairs, food court and rendezvous plazas, hosting festivals and parades, etc.

Signage, Lighting, and Individual Ambiance can be given architectural roots, and left to user embellishment. No busy settlement intersection need look like any other (e.g. the strikingly different, each stunningly beautiful stations on the Moscow Metro Circle Line).

To serve pedestrian traffic between parallel or neighboring streets in areas where intersecting streets are far apart, "shortcut" pedestrian "cunicular" tubes might be built. These will be small in radius, at best with a shallow side



terrace for hanging plants, flowers, bonsai forest strips etc.

### The Parking Question

Any discussion of streets not touching on parking would be critically incomplete. Off-street parking ramps or garages could be located next to intersections and/or mid-block as need suggests. Commercial and industrial streets with ramps sized adequately for customers and employees, could be paired with pressurized alleys allowing delivery and pick up of goods and wastes. Residential streets may have private carports or driveways, with visitors using mid-block ramps. In all cases, on-street parking, a form of unsightly clutter run wild in Earth cities, can be wholly avoided.

### Private Vehicle Options

In smaller settlements, bi/tricycles and even pedal driven family vehicles might not be uncommon. Amusement Park bumper car style personal trolleys and taxis are an option along with battery powered autos. Open, surrey, and convertible types will be common in the climate controlled environments of pressurized settlement streets.

### Public Transit Options

In the same environment, public transit vehicles can also be open-air, starting with simple railing-sided flatbed street rail cars with benches, operating automatically much as modern operator-free elevators. Trackless trolleys are feasible. Battery operated coaches will be more expensive to operate. In the light gravity of the Moon, side-rail suspended cars and vault-suspended monorail cars should be very feasible and popular. Station stops could be just before or just after intersection nodes, or handy to mid-block pedestrian bridges.

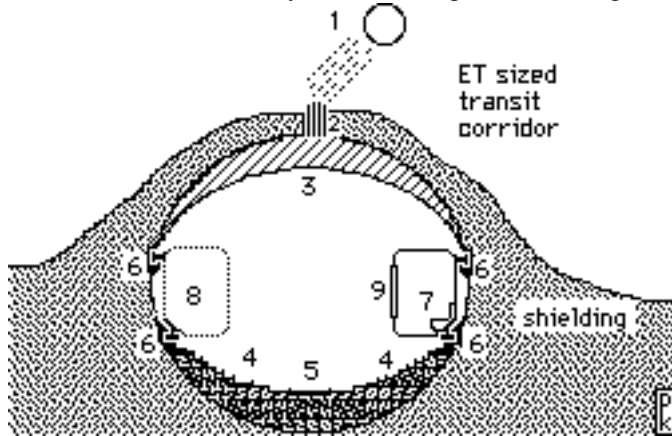

KEY: (1) Sun, (2) fiber optic bundle sun pipe, (3) sky-blue sunlight diffuser (same air pressure either side), (4) terraced plant beds, (5) gardener's path, (6) wall-mounted rail suspension system, (7,8) bench seat transit car, (9) door.

### Special Uses

Commercial concentrations can either grow up around favorably designed or well-placed intersections, or alongside individual street cylinders themselves. "Nucleus" intersections can be built at planned intervals, each to develop their own individual mix and ambiance as neighboring enterprises and cottage industries and neighborhood associations make use of them. One such may in time emerge as hub of "the downtown" but that can be left to the free unfolding of city life, and need not necessarily be preplanned.

Some streets may be specially designed to handle ethnic, music, and art festivals. Others can be laid out with parades in mind. And some should be intended to serve as park strips for retreat and relaxation and fuller enjoyment of urban greenery, maybe even token urban wildlife [see below].

[MMM # 92 FEB '96, p. 6 "Pioneer Holidays"]

### Custom Frontages

Pressurized residential lanes, commercial avenues, and industrial roads will each offer their respective frontage-holders the opportunity to landscape, remodel, and redecorate the entrance vicinities to their individual residences or establishments. It is this street-connected building interface which is the latter's public face. The out-vac exterior (elevations), in contrast, will in most instances be seen by very few, and consequently invite little image-broadcasting attention.

Each pressurized cylinder designed to host a streetscape will come (be built) pre-outfitted with a particular placement of doorways and doorway types, — dockage, if you will, for adjoining pressurized structures. The various side entrance formats will establish a fairly rigorous zoning regime: residential, commercial, industrial, agricultural, etc.

For proprietors and homeowners, flower and plant beds, whether merely decorative or useful (fruit, vegetable, herb & spice, dyestuff, fibrous, pharmaceutical, etc.) options are quite varied and lend themselves to personalization both in choice and arrangement. Complementing them, doorways and façades can be variously done in cement, ceramic tile, brick, stained glass, pebbledash, metal, etc. Holiday and festival decoration can be made of creations from harvested biomass.



Sidewalk section of a residential street, suggesting how homeowners might customize their entrance façades.

Pools of dayspan sunshine may mark every entrance to off street property, provided for in advance by the positioning of solar access in the cylinder vault. This external "atrium" can be contiguous to, or separated from, a larger solar garden atrium central to the home, etc. There are lots of options, and a healthy variety will be the result.

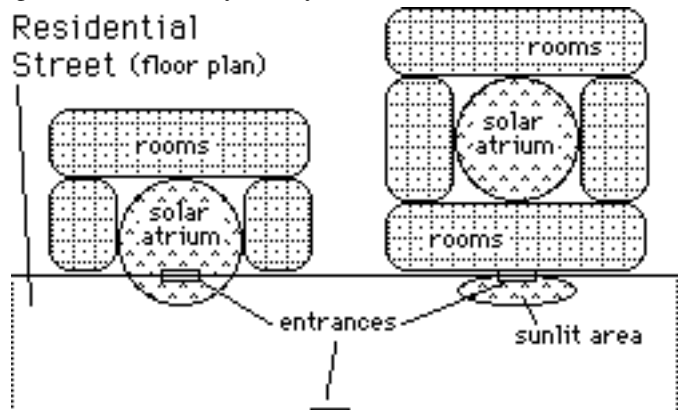

[MMM # 74 APR '94, p. 7 "Sun Moods"]

Each entry becomes the canvas for a distinctive

statement. The street frontage serves as the interface through which individual-private and shared-public worlds meet. The entrance, whether to a residence or an establishment, is a special fixed place that sets the mood and tone for all who enter. It says "I'm unique and proud of it."

There are, of course, also those several mobile interfaces with the world which accompany us on our excursions into it and through which we also state our identities: hairdo, cosmetics, jewelry, clothing, and personal vehicles. To serve all these markets for personalization, as well as in-home custom decor and appointments, a healthy variety of cottage industries will rise and thrive.

What about homeowners and proprietors who chose to leave their streetside home or establishment entrances and frontages uncustomized, anonymously undifferentiated, accepting the "issue" doorway and marker, etc. The city can either choose to accept this, so long as the public premises are kept neat and tidy, or set minimum standards for decor and landscaping, and, where these are not met, making the improvements itself to be paid by tax assessment on the negligent party - such is "the system" in Oak Bay, an affluent garden suburb of Victoria, British Columbia

Streets that serve food-production areas (farms) might be encouraged by tax law to provide adjacent small parks and garden spots for the public as well as roadside produce markets. Because there are no natural lunar annual "seasons", crop harvests can be staggered to occur every sunth (29.5 days). Fresh produce will generally be always available.

[If the settlement in whole or in part adopts a temperate climate with a hard frost sunth, in order to produce temperate zone fruits and vegetables, this would not apply. In this case, there could be two sunth-short frosts and two five sunth growing seasons annually.]

This said, however, in time, to serve growing demand for partially processed foods and the domestic meal preparation time-savings they represent, food processing enterprises may sprout up along these farm frontage roads. They will be supplemented by cottage industry home canners selling their wares in neighborhood markets. The farm road processing outlets will want to make their frontages as attractive as possible to potential customers. To do this they will use a variety of inorganic decoration methods, as well as landscaping and, of course, product display.

[for suggestions on alternative can and jar labeling, see MMM # 4, APR '87, "Paper Chase"]

### ***Doing Without "Commons"***

The "commons" are areas owned by "no one" — thus subject to neglect, trashing, and cancerous blight — or by "everyone" and thus maintained at taxpayer expense. The difference between the two is nothing more than a budget-mandated choice tipped by the good or bad graces in which adjoining property owners are held at city hall. (who is most effective in greasing the palm). Instead the city should be concerned with utility and recycling systems and biosphere regeneration and maintenance. These city gut systems can be maintained by youth during tours of "universal service" keeping the tax-supported payroll to a supervisory minimum. City adoption of "commons" area creates the temptation to

show favor and disfavor (e.g. to the rich and less-affluent respectively).

For areas available for planting and land-scaping, both options can and should be avoided. This can be accomplished by individual or corporate ownership of larger plots, and individual and group adoption of maintenance chores in the upkeep of smaller plots. Groups can be of homeowner cooperatives or business / marketplace associations. Garden spaces of spice and salad-stuffs can be run by local grocer/eatery coops. Decorative garden plots can be managed by cottage industry market coops placed within or alongside them.

The model for this is the spreading adopt-a-mile programs one sees more and more along the approaches to cities and towns in this country. Individual and group self-pride and good-natured rivalry combined with design talent and maintenance energies can lead to a very high average state of both adopted plots and the larger privately owned plots within the various street cylinders. Wealth, of course, will "out" and the adopted "commons" of more well-to-do areas will inevitably be, on average, more luxuriant and decorous, than those in lower income areas. Wealth, however, has no native monopoly on inventiveness, hard work, art, and ingenuity - these are the great levelers.

### ***Local Sign and Advertising Media***

Even without such terrestrial standbys as paper, cardboard, wood, plastic, and organic base paints, Lunan proprietors and entrepreneurs will have a variety of materials with which to produce signs and ad boards. For relatively "permanent" signs (street names, house numbers, etc. and business names) backlit mosaics of stained glass and front-lit mosaics of glazed ceramic tile are two of the more decorative possibilities. Engraved or bas relief monochrome ceramics and concrete, and metalwork signage of various sorts will also work. Neon signs, using easily recoverable solar wind gases (banked by adsorption to the fine particles in the upper layers of the regolith soil overburden) such as argon, neon, xenon, and krypton will be feasible.

For transient and frequently changing signage and advertising, digital electronic display boards may be the solution, though vegetable-based water colors on recyclable craft paper are a less expensive option. If you come up with still more ideas, please share them.

### ***Street Vegetation and Forestry***

Purely decorative flowers, plants, shrubs and trees producing neither food nor fiber, herb or spice, dye stuff or pharmaceutical, will be hard to justify. An exception might be a memorial floral gardens partially fertilized with the ashes of departed pioneers. Such a special spot is bound to become a favorite backdrop for wedding photos etc. Some small luxuries are simply worth the cost.

Fortunately, some environmentally conscious landscapers are having great success on Earth making decorative and ornamental use of food-bearing plants and trees. Pioneers may enjoy no oaks or elms, pines birch, or cypress - but there will be orchard trees like apple, pear, cherry, orange, banana and the like, and fiber-producing trees like Kapok. Others have suggested bamboo, useful for making informal furniture,

scaffolding, etc.

Personally, while I can see a great role for bamboo on nitrogen and carbon rich Mars, the idea of permanent withdrawals from the costly, volatile-limited lunar biospheres seems an obscene luxury. Perhaps it can be allowed if accompanied by a discouragingly high luxury tax, high enough to pay for the replacement volatiles involved. Along the same line, wood may be so precious on the Moon as to make it a favorite jewelry stuff. Hard cherry and apple would be natural for such uses.

The major determinant, however, will be the design climate of the street-grid biosphere. If semitropical, i.e. never freezing, we'll see a completely different list of food bearing plants than if it is designed to freeze seasonally, in temperate fashion.

Possibly various neighborhoods could be designed diversely in this respect so that the city as a whole enjoys a greater variety. It is the more likely that climate will be a city-wide choice, however, and that some towns will be temperate, others subtropical, others tropical, etc. Variety at the produce market will then come from vigorous inter-town trade. Such differences in town climates will also generate healthy inter-settlement tourism, making possible welcome changes of scenery.

Many fruit and vegetable plants produce blossoms prior to fruiting, and such blossoms can take the place of purely ornamental blooms in adding seasonal dashes of color and beauty. Simple juxtaposition of useful plants of various heights, shapes, and shades of green will be pleasantly decorative enough as a free plus.

As to trees, we will see a definite change in maximum allowable height as the settlements grow and mature. The first "pocket forests" may actually appear in early outposts - caricature groves of "pet" bonsai trees. There will be room for little more.

Next will come dwarf orchard tree varieties which can be planted even in in-home atrium garden solaria. But as street cylinders of ample radius are built, we will have room for much taller fruit and fiber trees, even bamboo grasses.

[MMM # 2 FEB '87, "Moon Garden"]

[MMM # 8 SEP '87 "Parkway"]

[MMM #50 NOV '91, pp. 8-9, "Trees on the Space Frontier"]

### **Urban Street Wildlife**

A biosphere without wildlife *might* be more efficient. But it would fail utterly to teach and remind young settlers of the host planet, teeming with wildlife, into whose midst the human species emerged. It will be both more educational and more morale-boostingly healthy to have *some* wildlife, however sparse and token.

The worthiest niche will be for pollinators. On Earth, these include honey bees, hummingbirds, some butterflies, and some bats. Their presence will give delight to many, as well as teach how real ecosystems work. Where plantings are in soil rendered from carefully aged regolith with the assistance of microorganisms, earthworms will introduce yet another phylum, yet another example of life's tremendous capacity for diversity.

A small captive flock of slow-breeding flamingos

might quickly establish itself as the popular town mascots without devouring too much recyclable biomass. Certainly such animal mascots would cost the settlement orders of magnitude less than would any human mascots of some monarchy!

If there are open water canals making use of reserve water in process of treatment for recreational use, these can be stocked with both game and decorative fish (e.g. trout and poi). A large aquarium would serve even better to teach and remind youngsters how life began, in the oceans. We hope to speculate more on such options in another article.

[MMM # 8 SEP '87, "Animal Life"]

### ***The Street Plays Host to City Life***

The first settlement streetscapes will be pretty drab. Few decor and landscape options; little variety in apparel; a paltry selection of consumer goods, mostly of crude "experimental" quality. As settlement industry diversifies in search of an ever longer list of export goods, new materials for building and crafting and artwork will appear, new finishes, new colorants, new tools, new methods. (Bear in mind that anything the settlers produce for themselves can be exported at a price advantage to other in-space markets.)

[MMM # 3 MAR '87, "Moon Mall"]

[MMM # 77 JUL '94, p. 8 "Cottage Industry"]

Variety and diversity will grow exponentially as after-work cottage industry activities arise to serve the unquenchable thirst for the custom, the different, the personal, the truly beautiful. Street markets, at first hit and miss in both times open and space will become regular, then permanent, and grow from flea market caliber towards a satisfyingly department-store-like spectrum of selections.

As versatile food crops increase in number, menus and cuisines will diversify and a wide range of interesting eateries and the odors associated with them will soon become taken for granted. As the variety of musical instruments fashionable from lunar materials grows, the number of good street ensembles will mushroom, as the number of a capella singing groups diminish (e.g. barbershop quartets).

[MMM # 3 MAR '87, "Moon Music"]

The more consumer products, the greater the volume and variety of discard objects. Reuse and recycling sorting bins and exchange marts will grow.

[MMM # 34 APR '90, pp. 3-5 "Recycling"]

[MMM # 66 JUN '93, p. 9 "Encyclobin"]

Because capital production equipment as well as service facilities to be enjoyed by all will be expensive, less will go farther if used and enjoyed, as the case may be, around the clock. The settlement will work three staggered shifts without chauvinist preference for one over the other. With the solar clock set on 4 weeks instead of 24 hours, different streets and whole neighborhoods can have their own day/night lighting cycles.

[MMM # 43 MAR '91, p. 4 "Dayspan"; "Nightspan"]

The corollary is that the neighborhood-joining commercial, market, dining and entertainment street areas should be alive, vibrant, and interesting around the clock. Market stalls and cottage industry shops might be time-shared

by coop members, or their goods sold round-the-clock by caretakers on a consignment basis. And always, the street will be the place to indulge in the universal pastime of people watching.

Whatever the part of 24-hour lighting cycle, settlement streets will take on a different personality and ambiance depending upon whether it is dayspan or nightspan out-vac. It is not only a matter of the availability or not of magically healing sunshine. The number of people on the street, their energies and moods, and the quantity of cottage industry goods available will all cycle with the local 29.5 day sunth. Many production employees will change from energy-intensive to labor-intensive jobs as night falls and with it the total available electrical power. Street activity cycles will follow suite.

[# 28 SEP '89, p. 3 "Choice of a Three Village System"]

Some landscaped areas will sport park benches for shoppers and workers on break to take a respite. Urban pocket parks work best if they are not secluded. People want to relax, yes, but such relaxation is enjoyed the more if it is in a peaceful spot *in the full midst of the vibrant city bustle* all around. Check and see: well-intentioned secluded urban parks are almost always relatively unvisited.

### ***Role of the Settlement College /University***

Any settlement institution of higher learning stands to play an enormous role in the development of the local culture and civilization and of the media and tools by which it is expressed. All this will be on display directly or indirectly on the streets. A university would assist on site companies in the development of new locally-sourced building materials, appropriate architectural systems and construction methods. Its research may contribute to the appearance of new finish and decorative materials as well as an expansion of the available color palette. All this will affect the basic appearance of the pressurized street cylinder and its decoration.

University assistance in cottage industry formation will help speed the diversification of products available in streetside markets and shops; development of musical instruments fashionable from local building materials will have its affects on the sounds of the street; development of new plant hybrids will enrich and diversify landscaping options; the list goes on and on.

### ***The Street as a Default Home***

What about those temporarily or chronically unable to come up with mortgage payments or rent? What about those who are willing or forced exiles from homes that were dysfunctional so long as they remained in them? What about those overcome with mental disorders and disowned by relatives and friends? Lunar towns fly the flag of "Tanstaaf!" - "there ain't no such thing as a free lunch." *Every pioneer is expected to be productive.*

It may be required of all who would come, or of their corporate sponsors, to place in escrow funds for return passage to Earth in case they grow unhappy with settlement life or should the settle-ment becomes dissatisfied with them. This measure will take care of some of the problem and minimize the effects of economic dislocation and job loss. But people will still fall through the cracks that remain.

There is hard work out-vac, building roads and

bridges over rilles, erecting habitat and other pressurized structures, mining, and other sundry field work tasks needing to be done if the settlement is to survive. It will be work that will attract some, but too few. Here then, is a niche for an out-vac service corps into which the temporarily or chronically dislocated can serve in exchange for food and lodging *and the buildup of a nest egg for a fresh start*, a fund that cannot be touched until it reaches a certain minimum. In addition, there may be in-city universal service type jobs going unfilled by the available youth pool (of say 18-20 year olds). There will be opportunities, too, to join other lunar and off Moon settlement endeavors, hard pressed for recruits (Mars, Ceres, etc.). Such efforts may oft' be sink-or-swim enterprises tending to shape up those involved.

Any such potential problem as homelessness must be tackled on many fronts. Prevention is vital. Vocational and occupational job counseling and retraining; pre- and post-marital counseling; parental and family counseling; crisis management; work schedule options; residence options, etc. Some of the bill for this work might be paid out of a tax on companies doing work on the Moon and importing workers and their families. The rehabilitation work might in part be done by OMOs, occupational maintenance organizations. What is needed is not job "insurance" (i.e. unemployment compensation) but job "assurance". But there remains leftover work and vocation aplenty for service clubs, religious orders, and churches.

Those still falling through the more stubborn cracks can be provided storage lockers for what belongings they retain, lockers to which is attached a legal address for receipt of mail, and for listing on job applications. This host facility might provide cooking facilities and showers. Use of such a facility will bring with it a requirement to participate in retraining and rehabilitation programs. This is in everybody's interest. Tanstaaf still rules!

The criminally misfit need to be handled in the same comprehensive way. We cannot afford to lose a person's potential productivity through money-, personnel-, and resource-sucking incarceration. Involuntary out-vac service corps work, as outlined above, should be the extent of punishment, as opposed to rehabilitation, repatriation to Earth, or reassignment to asteroid colony backwaters.

[MMM #35 MAY 90, p. 3 "Ports of Pardon"]

### ***Gateways and Highways to the Hinterland***

In its infancy, a settlement may do well with a single gateway, a bank of docking ports for out-vac surface-plying trucks and coaches. But if and as the town grows, the need might arise for a number of peripheral gates, depending on the way highways to and through surrounding areas radiate outward from the settlement site.

In time the original town limits will be leapfrogged and the various gateway dock areas find themselves surrounded by urban development. New gateways will emerge along the new outskirts. But the older ones may remain for express pickup and deliveries to various points within the now larger city. These might be reached by surface express routes. Neighborhood gateways will attract adjacent in-city commercial and market development, park plazas and entertainment

zones, hotel/motel and apartment concentrations, etc.

Where these city-top express routes are plied by public coaches, adjoining property owners may feel a belated need for surface decoration or adornment of previously plain regolith shielding mounds. [MMM # 55 MAY 92, p. 7 "Moon Roofs"]

### ***The Unfinished City***

*"Praise be the darkness, and Creation Unfinished!"*

Ursula K. LeGuin in "The Left Hand of Darkness"

If any of us came into the world to find it, its culture, its civilization and cities "finished" we'd be at an intractable loss to find personal meaning or significance to our lives. It is because the world and the city *is* unfinished that it is both breeding ground for evil *and* an opportunity for good.

Urban planning must always remain tentative, confine itself to infrastructure and resist the temptation to divinely proclaim the details, stifling individual initiative and expression, suffocating the vibrant vitality that comes from unexpected spontaneity. The city is livable only to the extent that for each of us there is an opportunity to contribute our own individual "brick(s)". The off-Earth "Xity" [= a city that has to concern itself with creating and maintaining its own biosphere] is a shared undertaking of unprecedented challenge and scope.

As such the proposition to establish a "Xity" will attract architects and city-planners who would play god, deciding everything, reducing all who shall ever after live therein to lives the more meaningless because of the lack of opportunity to help finish the unfinishable city. It is only the unfinished city that lives, that is alive. Future off-planet cities, whether they be on alien surface scapes or within O'Neillian rotating constructs, must begin life only partially determined. This is a challenge foreseen, to be sure, by *no* science fiction/fantasy artist with whom I am familiar. *Their* cities are all *uniform* in architectural style and plan, *all new* (rather than a mixture of new and old) and inevitably *gleaming*, as if created not bit by bit like living world-challenged things, but all at once like some bauble in a bubble.

Enthusiasts captivated by such untrue-to-life artistic renderings may not make the best pioneers. The frontier will always have rough edges and the pioneer's calling is to smooth them down, one at a time. There will be no abracadabra cities out there, just frontier towns whose inhabitants will find their lives enriched with the real life chance to make a difference, to help finish the never finished.

Examine yourself, score yourself, and take another look! Because it is so *very* unfinished, the frontier settlement or city will be most rewardingly livable. To be sure, the great megastructure cities such as O'Neill colonies, proposed domed craters, vaulted rilles, the main "plaza" structure depicted by Rawlings in Ben Bova's "Welcome to Moonbase" are visually alluring and inviting. Their high ceilings allow expansive vistas within which individual dwellings and other buildings can be built using familiar construction methods to create Earth-mimicking urban environments. But despite their postcard-worthy panoramas, such fixed-size cities will quickly become vitality-suffocating unless they are somehow able to expand in modular fashion (as in the Prinztown study of vaulted rille sections built as a series of villages in multiples of three\*. The

discussion is moot, however, for in the near term, only modular lunar and space settlements can have realistically affordable construction and early occupancy thresholds.

<MMM>

\* "Ventures of the Rille People" in MMM #s 26, p.3; 27, pp. 3-5; 28, pp. 3-4; 29, pp. 3-5; 31, pp. 3-5; 32, pp. 3-6

\* Precedings if the 10th Annual International Space Development Conference, San Antonio, TX, May 22-7, 1991. pp. 75-92 "The Lunar HOSTEL: An Alternative Concept For First Beachhead And Secondary Outposts", P. Kokh et alii, © 1991, The Lunar Reclamation Society.

## MMM #110 - NOV 1997

### ***Welcome to New Atlantis, Europa***



At the 2nd iteration of LRS' Europa Workshop (the 3rd will be held at ISDC '98 Milwaukee), one of the things talked about was the natural (or artificial) possibility of pockets of trapped volcanic gas (CO<sub>2</sub>?, 15 ATM?, 50° F?) in concavities in the underside of the ice crust, guesstimated at 1-5 km thick, but possibly thinner here and there. Such a harbor could be an interesting place to have a submarine base. Add artificial light, a pressure dome and ... ⇒ More below.

[“Xity”: a city that must establish its own biosphere]

## ***“Reclamation” is a Xity’s Charter Junction***

### **Historical Precursors of Reclamation**

There are precursors of reclamation, at least of the con-creation of a settlement's own eco-niche, scattered throughout human history. In many areas throughout the world and throughout history, areas at first unpromising as settlement sites have been transformed by hardworking pioneers into what are now some of the richest, most fertile lands on Earth.

[As we have remarked before, this is an instance of the unsung Beatitude: “Blessed are the Second Best”, i.e. those unable to compete where life is easy, forced to move to less promising outbacks, left to fall back on their own resourcefulness and to make do with less.”]

River-hugging farming villages have succeeded in greatly expanded their productive farmlands by reclaiming adjacent expanses of desert through irrigation. Similar villages

on narrow plateaus or in narrow valleys have done the same by learning to terrace the surrounding mountain slopes, thus reclaiming them from barren non-productivity.

In the Netherlands, the Dutch have learned to build dikes to tame the tides, then to drain the backwaters and establish fertile non-saline farmlands, called polders\*. And so they have reclaimed relatively worthless sea bottom and tidal flats. The dike is the analog of the pressure hull, the polder of the modular (or, someday, monolithic) hullplex that contains the settlement's biosphere. For the Dutch, this ongoing annexation of turf, formerly surf, has continued for centuries. To live is to grow is to keep reclaiming ever more wasteland and transforming it.

The great dike that created the fresh water Zuider Zee from the once saline Isselmer, a bay of the North Sea, is like a giant sun-shading ramada, in that it creates lee space within whose shelter, reclamation can proceed at an even faster pace. The peat mined from the freshly reclaimed sea bottom lands prefigures the solar wind gases to be scavenged from the lunar regolith during site preparation, building materials processing and construction.

Nor do the Dutch toil just to increase their annexed farmlands, they toil to maintain them, even as space pioneers will have to do. Maintenance and growth have to proceed hand in hand. Eco-niche lands won from the sea bottoms, whether of oceans or of space, must be defended ever after. Life always strives against entropy. Rest is fatal. Reclamation is the life of the desert oasis, of the mountain-terrace farming villages, of surface settlements on worlds not blessed with oxygen-sweet atmospheres.

[More on the Polder Analog: MMM #38 SEP '89 pp. 10-13 "Polders: A Space Colony Model", by Marcia W. Buxton.]

Because of this "charter burden" these precursor settlements on Earth might aptly be called "xities" (in so far as they are at least biosphere-challenged in comparison to other, at first glance, more propitiously sited towns). And that should give us all comfort and encouragement, we who would establish "xities" *beyond* Earth's biosphere altogether, not just beyond its more fertile reaches. There is precedent. We have spiritual ancestors. Their success gives us models to follow. We are not alone. What we would do emerges as a natural extension of what the best of men have tried and succeeded in doing before us.

It is the Epic of Life, in which the hero thread continues to be carried by the Second Blessed. We who find ourselves stifled and hamstrung on Earth where life is easy, it is we who hear the call to pioneer where life must be unimaginably harder, where left to our own resourcefulness, we have a chance of living a life more satisfying than any we could hope to live here in any of the genteel soft-edged Baltimores of Old Earth.

Space pioneers will learn to reclaim the sea bottoms of space, i.e. the vacuum-washed surfaces of barren worlds like the Moon, annexing areas bit by bit into growing pressurized modular mazes. Herein they will not have simply enhanced a local portion of a given common biosphere, but *created* a biosphere from scratch, where not even the seeds of one existed beforehand. As the settlement grows, as more and more

of the space sea washed surface is incorporated into it, won from the sterile vacuum and turned into verdant farms and luxuriantly green villages, the infant biosphere will grow in mass, in reserves, in diversity, in resiliency, and in the satisfactions of life it affords its toiling inhabitants. Reclamation *is* the xity's job, and the xity will thrive as long as it continues to pursue this goal.

Under the aegis of "reclamation" will fall all the major manpower using tasks of the Xity, at least in an oversight capacity: new expansive construction, using export production byproducts for that purpose, pressurization maintenance and repairs, air and water recycling and refreshing, and the food cycle that is part and parcel of those two tasks. It is the indivisibility of its biosphere that gives the xity a charter monopoly on these reclamation tasks.

Reclamation is appropriate in all parts of the Solar System beyond Earth's sweet atmosphere, in free space itself, on Mars and among the asteroids, on Europa and Titan, and wherever human resourcefulness will find a way to establish viable biospheres in which we can live and grow.

Perhaps many a reader has found the name of our society esoteric: The Lunar *Reclamation* Society. But if "Communities Beyond Earth" are our common goal, then it should now be clear that LRS is right on target in defining the challenges.

<MMM / LRS>

## ***Roots of Civil Authority on the Moon***

**From government science outpost and/or  
company town to civilian settlement:**

**a "Trial Balloon Scenario".**

by Peter Kokh

[Your constructive comments welcome.]

Three "return to the Moon" scenarios have some degree of plausibility:

- An International Science Station with limited ability to carry on processing and manufacturing experiments.
- A Commercial Outpost, such as the proposed Artemis Moonbase™ which pay back its investors and earn its upkeep, and hoped for expansion, by any buck-turning method it can.
- A multinational Company Town seriously engaged in mining and manufacturing e.g. components for the proposed (Criswell et alii) Lunar Solar Power Array on the limbs of the Moon's Nearside.

The planners behind each of these prospective efforts will likely have their own short list of favored surface locations. Yet it would not be surprising that for the benefit of shared logistics, efforts getting to first launch date second or third, may scrap such plans and decide to site their operations nearby, if not contiguous to whichever outpost effort succeeds first in becoming a functioning reality. *My presupposition here*

is that it might make economic sense to share a site and with it, any logistical advantages. Consider these points:

- Ready landing / launch pad and facilities
- Ready Communications facilities: sending and receiving antennae
- Piggyback resupply with the advantages of timeliness, flexibility, and lower cost
- Possibility of time-shared specialist personnel
- Possibility of emergency loan of specialist personnel
- Additional rescue options, including abort to the (an) other nearby facility on the Moon.
- Option of splitting the construction, supply, and staffing cost of expansion facilities which might benefit all parties.

This is not dissimilar to auto dealerships grouping together to share traffic that increases because of customers' heightened expectations of finding suitable buys in one general location. For the same reason, tourist attractions do much more business when grouped together than when situated in mutual isolation

One might suppose that we'll be darn lucky to see just one of these developments, that setting up operations on the Moon is just too expensive. But that depends on who does what first. A trailblazing multigovernmental science outpost could indeed be preemptively expensive. But a government effort that used infrastructure and hardware pioneered by a commercial and/or industrial effort might achieve the same goals, *and more*, at a fraction of the cost.

The drivers for each type of effort are quite different. As to siting, an industrial base slaved to a Criswell type lunar solar power array project, will enjoy the least leeway, and is likely to be part of a contiguous operation only if it is first to set up. There are, to be sure, other industrial outpost scenarios that would be much more flexible as to site (Helium-3 mining, Oxygen production, Glass composites production etc.)

What about a lunar south polar ice-harvesting operation? That's a hard one\*. Either pole is a poor place for an industrial setup (the water produced there will be far less in weight ratio to all the other elements needed for manufacturing, which are best produced elsewhere, e.g. on highland/mare "coasts". It will be cheaper to ship water than all the ore.) If such a polar outpost is first, then it almost certainly will lead to a larger, however dependent, operation away from the poles.

\* [MMM # 104 APR '97, pp. 6-7 "Ice Logistics:

Getting lunar polar water ice to thirsty industrial settlements and bases elsewhere on the Moon"]

This in mind, let's return to our question.

How do we make the leap from government science outpost and/or industrial company town and/or a for-profit commercial base to a civilian-run settlement? What are the possible origins and roots of citizenship and civilian authority on the Moon?

For until we have that, be it on the Moon or elsewhere, we are simply deceiving ourselves and settling for far less than our vision if we think either of these startup beachheads by itself qualifies as a "Community beyond Earth" in any but caricature terms. I propose that not any set population size but rather the mix of diverse types of early lunar startup operations will form the "critical mass" to give

birth to a truly "civilian" authority. Consider these new expansion functions the charter parties might want to turnover to a "host" authority:

- Building and maintaining new pressurized expansion space for housing, offices, laboratories, a hospital, a tank farm for both imported and locally produced volatiles, food production areas or farms, entertainment commons, media studios, hotel space and tourist facilities, etc. etc.
- Expansion and maintenance of the Closed Loop Life Support System, or Biosphere in the making, integrating food production, codetermining the city plan layout, etc. i.e. the *Charter Job of Reclamation* (see previous article, this issue).
- Negotiating the terms of participation of additional community partners: additional government and institution-backed science facilities, additional commercial enterprises, additional industrial concerns . growing the common pie.
- Working for economic diversification:
  - encouraging new by products
  - encouraging new suites of processing
  - encouraging manufacturing ventures both for export and meeting local expansion needs
  - encouraging formation of new subsidiaries
  - recruiting new commercial and industrial ventures in trade shows and missions on Earth
  - in general pursuing economic break-even, being able to pay the entire import bill with profits from exports, plus earnings to spare.
- Expanding space port facility: additional pads, unloading equipment, etc.
- Warehousing surplus supplies needed by all, building up reserves to counter temporary or indefinite loss of Earthside support of one or more of the founding partner enterprises.

This role, this vocation, these tasks cut out for it, the city will stimulate the appearance of new business tied to expansion: manufacturers of building and utility components, and furnishings (all of which can also be exported at a cost advantage over Earth-made products to other in-space locations), construction contractors, biosphere system component manufactures, and so on. The city will be on the road to major diversification of the work force, and the economic base will steadily grow more viable.

Such expansion can occur by budding, i.e. the creation of subsidiaries of an original mining-manufacturing-processing company; or by joint ventures in which fresh capital and resources are contributed by terrestrial companies previously not doing business on the Moon; or wholly by bringing in such new companies. And as the local population grows and the population (even transient tourist concentrations) of other in space markets grow, commercial enterprises will bloom as well. But let's get back to beginnings.

Let us now assume that all charter parties have this problem in common. Personnel are on the Moon for limited tours of duty. Because it saves a pair of man-trips Earth-Moon and vice versa to have an on site staff or crew person or worker to "re-up" and reenlist four another (an extended) tour, we can assume that in each outpost effort, there will be a number of men and women who choose to stay on, the percentage

growing as more and more perks and amenities come on line, i.e. as the infant would-be community becomes ever more “homelike”, as individuals acclimatize themselves ever more easily and comfortably.

Now this leap of faith, if you’ll humor me. It is likely that some percentage of employees or crew of each charter outfit have some talents and qualifications in common. Why not a joint agreement between the parties that after two terms or two years of continuous service on the Moon, an individual has the right to choose “**free agency**” and sell his services to the highest bidder, or to the bidder who offers the most attractive individually tailored package? Return fare to Earth would be held in escrow for all, and it could be agreed that this was portable. This free agency program could work to create greater morale overall, long term, and thus be in each party’s interest. A court or adjudicator on the staff of the new all-conjoining “Reclamation Authority” could see to it that the free agency provision or agreement ran smoothly and fairly.

Next Leap of Faith: Free Agents could be considered citizens of the new conjoined community who are subcontracting themselves out to their new employers. We now have an incipient and forever growing population who are properly speaking lunar citizens, or citizens of the new conjoined community rather than simple company or agency employees whose rights are at the whim of their contract holders.

### **That’s one small step for a man One giant leap for the community**

From this it is a small step to a civil law or constitutional “right” that such free agents are free to socialize, enter relationships, marry, start families, etc., rights that their original contract holders would never countenance, not for a moment! Whether or not they individually choose to stay on for the rest of their lives or for only a few years, we’ll have the first real lunar civilians, the first real citizens.

Prior to this time, the various authorities will be conservative, not willing to permit anything such as a pregnancy brought to term on the Moon that *might* demand a commitment to an indefinite human presence. “We don’t know if it is safe” will be the inane mantra — inane because, as we have pointed out before\*, “until we’re sure that the 2nd native generation is healthy and fertile, we won’t *know!*” It is a knowledge that can only be had by taking the plunge, with all the risk and courage and faith that this implies. The 1991 made-for-TV (ABC) David Lee Zlatoff film “Plymouth” was right on the mark.

\*[MMM # 47 JUL ‘91, pp. 5-6 “Native Born”]

[MMM # 52 FEB ‘92 pp. 3-5 “Xititech”]

As opposed to the contract employees of the various industrial, commercial, and science outpost partners, the emergent constituency of free agents now for the first time, and alone, have a natural interest in the long term continuity and continued growth of the new born settlement. It is in their interest to see develop a full range of life-interest opportunities including careers and personal relationship options: free and open fraternization, marriage, the right to bring children into the community, and eventually, the right to retire, die, and be buried there. Such free agents stand to be the first seed of a non-transient population, even though most of them may

themselves individually “choose” to return “home” to Earth sooner or later. So long as that is a “choice”, presupposing the alternative “choice” to remain for the rest of their lives, we will have successfully made the magic jump from outpost to real settlement, akin in its momentousness to the magic jump from early biochemical activity to true reproduction - and life. It will be the free agents who force a “sea change” expansion of the city’s “agenda”.

Of course, to allow all this to happen, the city must provide some key services: hospital with maternity facilities, schooling, programs to extend the productivity of seniors. This would seem to require, following universal Earthside practice, the employment of a lot of people not directly involved in bottom line productivity: the manufacturing of exports with which to pay for necessary imports.

Not so! Schooling can be provided by Earthside teachers, interacting with their lunar charges via the TV monitor, even with the 2.5 second delay. Or by interactive video programs and a minimum of on site human tutors. As they grow older, the kids can take over many of the house-keeping chores of the settlement, releasing adult manpower for production.

Health care can be proactive, and with continuing adult education being the norm, the artificial retirement ages we worship in the West can be dispensed with. As people reach an age where they need to work less hours, they can take over various administrative, educational, and service tasks. And before this manpower pool comes on line, many administrative duties and chores can be “farmed out” electronically to less expensive Earthside personnel. Upshot: developing a growing fraction of non working age adults need not be suicidal for the community.

Now the “City” that results will begin with two classes of members: corporate or government, and individual citizens. Which suggest some sort of bicameral legislature. If this brings back memories of World War II era fascist corporate states such as Portugal, so be it. There is no relationship, and no reason why the new all-subsuming Lunar City cannot be a true and genuine democracy.

A corollary of all this is that the emergent Lunar City must have a certain real autonomy of home rule, responsible to all its charter partners and individual citizens, but beholden to neither. Some form of United Nations joint-trustee-ship (say of the various nations from which the charter partners are supported) would be in order. The U.N. trusteeship Council might negotiate with the City terms and milestones according to which this incipient autonomy and home rule is gradually increased and expanded in scope until some distant day when the lunar population is truly self-supporting (able to pay for whatever it imports out of the profits from its exports; with ample reserves; with a full suite of institutions {medical, educational, etc.} to serve its citizens needs; and with prospects for expanded trade and growth in the future). At such a time, then with a population of many tens or hundreds of thousands, the Lunar Community or federation of lunar communities might take its place as an equal among the nations of men.

An ambitious dream, but one that can start humbly with a few well-chosen steps and the right mix of contributors.



It is for sure that a multi-government science outpost by itself is poorly set to make such a profound transition. And we could say the same of any “One Company Town”. A Commercial Base, however, might someday make the magic metamorphosis on its own. But the best and surest bet is a conjoint effort by several diverse partners, giving rise to an overarching reclamation-biosphere-expansion authority subsuming them as charter partners.

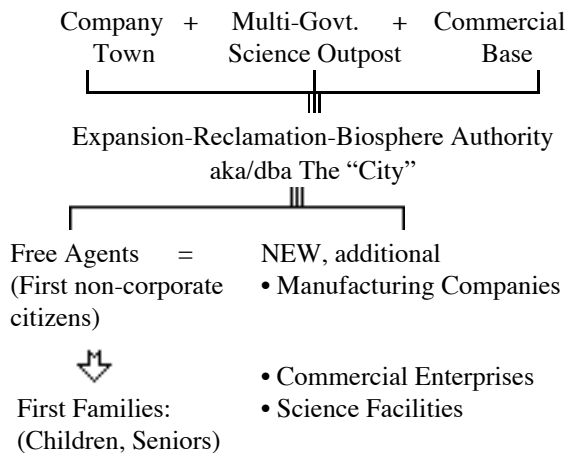

[We’ve labeled this a trial balloon scenario, a first attempt to imagine just how the transition will be made from an initial transient beachhead, a caricature of a community, to the first real self-perpetuating community of humankind beyond the Earth’s atmosphere (the National Space Society’s stated goal).

[As a trial balloon, we expect it to have omitted many key elements that have not occurred to us, along with forks in the road whose choice is up in the air, and some naive assumptions. We offer it as a point of departure for discussion only. If we have succeeded only in heading off at the pass a contraceptive wave of complacency after a first science outpost is established, we will be delighted. Even now, there are already too many in our space community ready to settle for such wooden nickels.

[Reader input from brief letters to whole essays are welcome. — The Editor.]

<MMM>



## *In Memoriam* *James H. Chestek*

MMM is saddened to report that James H. Chestek, P.E., 68, died on September 27th, 1997 of a heart attack. Jim had retired from a 35-year career as an aerospace engineer, and brought his professional expertise, enthusiasm, and sense of humor to NSS Philadelphia and the Philadelphia Area Space Alliance. Most recently, he co-authored, with Donald Cox, *Doomsday Asteroid, Can We Survive?*, published late last year, and presented talks on asteroids to local organizations. You will be missed, Jim.

Jim Chestek was a contributor to MMM.

[MMM # 85 May 1995, p 9. “Lunar Jumping Jeep”]

[MMM # 102 FEB ‘97, p. 6, “Save the Lunar Ice!”]

# *Lunar Quarantine Facility* *for Mars Sample Returns*

by Bob Bialecki and Peter Kokh

Perhaps it’s an occupational hazard. Not too long ago, I happened to watch Ted Koppel’s Nightline (I’m usually asleep in bed by that time, 11:30 pm in Milwaukee). And lo and behold he was indulging himself in tabloid journalism. Or more accurately, he was not knowledgeable enough to spot the flim flam nonsense of the self proclaimed expert who was shouting: “doom, doom! NASA is planning to bring Martian germs back to Earth where they will destroy us!” Of course, Koppel gave the obligatory equal time to a NASA spokesman who tried to be reassuring.

The salient points are:

- Martian organisms may indeed have arisen and evolved on their own up to some primitive point. (They had less than a billion years of prime time — it took three billion years for prospering Earth life to get beyond the one-celled stage.) But, even though primitive terrestrial organisms have been revived after a state of drought-induced stasis lasting hundreds of years, it seems quite a leap of faith to think Martian organisms might similarly have “hibernated” “successfully” for billions of years. All during that time, Mars experienced not only forbidding cold and severe desiccation, but relentless exposure to the full fury of the Sun’s ultraviolet rays. UV works swiftly to “destructure” [the etymological root of “destroy”] organic compounds and tissues. The thin Martian atmosphere, as much of an asset as it is for the mining of volatiles and for aerobraking lift by descending vehicles — (it offers no protection against ultraviolet radiation (put the stress on *radiation!*)

To be sure, optimists have offered scenarios for survival, such as burrowing into rocks. This is a defense of inexorable attrition at best, as rock surfaces are constantly being eroded in the dust-laden abrasive winds of the thin Martian air.

- Predators co-evolve with prey. You can’t expect organisms, should they have survived for three eons (Sagan years) against all odds, however adept they are/were at getting their dinner without permission in their native ecosystems, to find organisms with no-shared ancestry, perhaps no common proteins or amino acids, equally tasty let alone more so.

- The argued evidence we have for Martian life is not direct. We have no fossils, no DNA, just “tracks” and “footprints”. We have no evidence that any ancient Martian organisms have survived — even in death! And we have no non-temperament-induced reasons to believe we shall ever find real organic “remains”. even long dead ones.

Of course, it would be great if we could find such relics. We could deduce from them points of difference and similarity with Earth life, even settle the question of shared, derived, or independent origin (Mother/Daughter, Sister/Sister, Stranger/ Stranger) of the two life strains.

Even if, happy day, we did find such remains, even if we found them in profusion, it is unlikely that we will ever find anything intact enough to be revived or even be recopied and

rebuilt, Andromeda Strain fashion.

So my reaction (PK) was to rail against Ted Koppel and his journalistic shortcomings and to dismiss the whole “Chicken Little” brouhaha. But fellow chapter member Bob Bialecki had quite a different reaction to the Koppel episode, which he also had seen. “If there is this fear in the people out there, why tilt at windmills trying to defuse it in an expert vs. expert battle we are likely to lose? Why not accept that fear as a given and address it in a way that serves our own purposes?”

Koppel’s expert had correctly pointed out one could-have-been fatal flaw in the quarantine procedures used for the returning Apollo astronauts and their precious moon rock and dust samples. For in fact, ocean water was allowed to freely wash over the astronauts’ “dust contaminated suits” and then to spill back into the ocean. “Why not,” Bob said, “call for all Mars Sample Returns to be brought back, not to Earth, where absolute quarantine is impossible, but to the Moon where fail-safe quarantine measures are simple to arrange, guaranteed by the Moon’s sterilizing radiation-washed vacuum?”

It is easy to retort that this involves unnecessary expense. After all, all but the most romantic are certain to the umpteenth power that nothing now lives on Mars. Certainly, such a facility would be an expensive adjunct to an international lunar science outpost. Is public panic deep enough to loose the purse strings that much? Many an unwise compromise has been justified in the past in the name of responsible frugality. We could expect elected government officials to side with more rational scientists against the need for such measures. A Mars Sample Return Quarantine Facility would almost certainly be an outgrowth of a lunar outpost, not it’s primary reason for being. So if the powers that be aren’t already sold on a Moonbase on its own merits, that poses a problem.

Now what if a much less expensive more modest outpost was built from, and delivered to the Moon by, existing hardware, financed by investors expecting profits - á la Artemis Moonbase, for example? Then an economical neighboring Mars Sample Return Facility could be set up and run by the Artemis people, for a profit, of course, the fee it charged whatever Mars exploring space agencies brought the return samples to the site.

<BBIPK>

## Europa Workshop II

Mission Control™ Workshops, an educational activity of the Lunar Reclamation Society, Inc.

First Contact IV, Sept. 27, 1997 — Peter Kokh, Mark Kaehny, Doug Armstrong, and Ken Burnside

[The kick off Workshop in this series was held at Duckon in Oak Brook IL, June 7th, 1997 with Peter Kokh, Mark Kaehny, and Bill Higgins leading the discussion, along with several other participants. This brainstorming will come to a head in the Europa Workshop at ISDC ‘98, Milwaukee, WI, May 22-26th.]

### Just the Facts

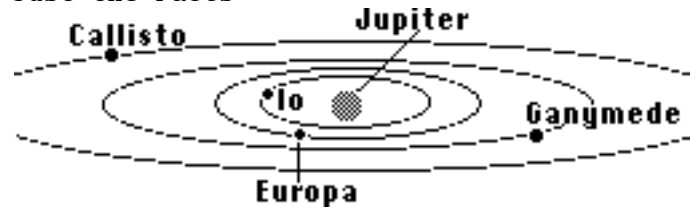

Europa orbits 416,200 miles out from Jupiter  
(The Moon orbits 238,500 miles out from Earth)

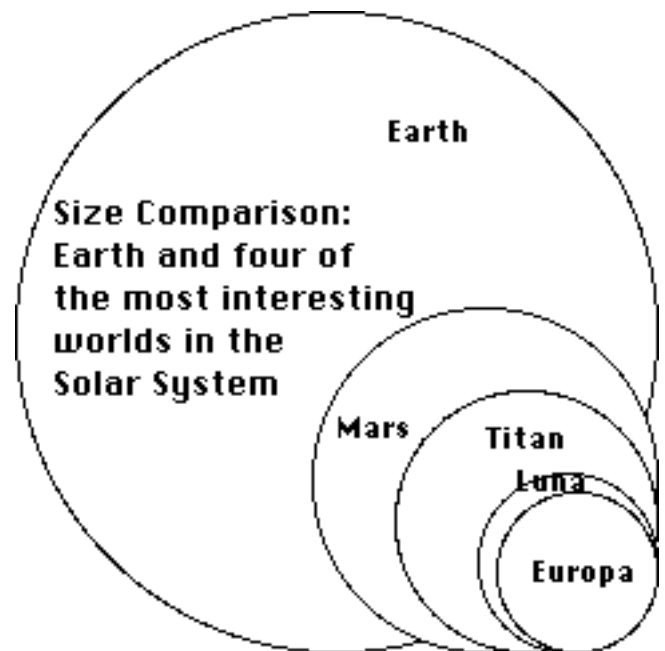

- **Europa’s diameter**, 1942 miles, is 90% that of the Moon’s, 2160 miles. Europa has 81% as large a surface area as the Moon, or 11,857,000 square miles, four times the continental U.S.’s 48 states.
- **Europa’s Mass** is 2/3rds that of the Moon.
- **Europa’s gravity** is about 1/7th Earth normal, 14%, compared to the Moon’s 1/6th normal, or 17%.
- **Europa’s Day / Night cycle** is 3 days 13.3 hrs long with two of these periods just 2.6 hrs longer than the standard week. An Outpost could make sense of this by dividing the day/night cycle into 3 clock days of 28 hrs 26 min. each, 6 to a week. Digital watches could be programed to reset accordingly.

### Forward

The widespread interpretation of the Voyager photographs of Jupiter’s 2nd innermost great moon Europa, is that here we have a world with a global ice crust floating on top of a global ocean of considerable depth, covering a rocky crust-mantle-core. Current best guesstimates, reargued from scratch from recent Galileo mission photographs, are amazingly close to those offered a decade or more ago by astronomy “bad boy” John Hoagland. The ice crust is on the order of 1-5 km thick, the ocean beneath it could be a 100 mi. or 60 km deep, *likely holding almost twice as much water as all the oceans of Earth*. While we have not had on scene the instruments necessary to make direct measurements, it’d be surprising, if this picture is “way off”.

Tidal stresses caused by Europa’s not quite circular

orbit around Jupiter evidently supplies the heat to keep this ocean liquid. In ancient mythology, Rhadamanthus was the son of Europa by Jupiter. So *The Rhadamanthic* seems an ideally appropriate choice as a name for this hidden global ocean. Water and vacuum do not socialize. But ice and vacuum get along quite well. A thick enough self-derived icy “firmament” can contain an ocean just as effectively as does Earth’s thick atmosphere.

The conditions for the formation and maintenance of *Europa*-like moon worlds seem rather easy to meet in the vicinity of gas giant planets. And gas giants should be quite commonplace throughout the galaxy. *It will matter little if the Jove-like primary of the candidate moon does not orbit a sun-like star.* The upshot is that there may be far more “Europids” in the galaxy than planets more like “Earth”. What we are able to do at / with Europa, may provide the major theme of any human thrust to the stars.

[see MMM # 36 JUN ‘90, pp. “Oceanids”, P. Kokh]  
republished in MMMC #4

*What do we, and don’t we know about Europa?*

Maximum elevation differences in the surface are on the order of 100 meters, 300 feet, making Europa flatter than Florida, globe-wide. But ice, even very cold ice, is plastic, so we can argue from the analogy of icebergs that the surface profile is matched by an exaggerated unevenness of the ice crust undersurface. And where we have low spots on the surface, there the ice is correspondingly thicker, being matched with an exaggerated concavity on the underside.

We don’t know the amount of impurities in the ice nor of *salinity* in the ocean. The mechanism that led to Earth’s “briny deeps” was /is continual runoff from above ocean continents into the oceans via the river systems. This mechanism does not operate on Europa. There could be some level of salinity, however, if there are, or have been in the past, undersea volcanoes or deep vent ridges. Some of the material from eruptions could percolate into the water and go into suspension or solution. Volcanism is also the only possible source of dissolved gases (e.g. carbon dioxide) in the water.

But we don’t know if there is, or ever has been geological activity in this undersea crust. We don’t know if it has mountains and undersea continents and basins - or is relatively flat. We don’t know a lot. No mission to Europa is now in the works, although a number of missions have been brainstormed to some degree. One cheap and elegant mission proposal would “sample” the chemical content of the ice crust by a simple flyby mission. Upon nearing Jupiter, the probe would aim a “shot” at Europa calculated to splash representative material into space. The probe would then “catch” some of this sample in an aerogel shield as it flew through the splashout cloud. On board instruments would analyze the “catch” and send the information back to Earth by radio.

Our Workshop series aims to ferret out ideas for robotic and follow-up manned missions to Europa, both to its ice crust and through the crust into its Rhadamanthic Ocean.

#### **PRECURSOR ROBOTIC MISSION(S)**

At the recent Europa II workshop, as we lacked a

critical mass of participants to break up into sub groups, we decided to concentrate on manned mission possibilities. This is perhaps a good thing, because we quickly realized that *for a manned assault to be successful a number of questions would already have had to have been decided by robotic missions.* So the manned mission is the dog that wags the robotic tail, and any brainstorming of robotic missions without consideration of the needs of follow up manned efforts would be so much irrelevant ivory tower scientific curiosity scratching. Let us hope we will soon graduate to “prospecting mode” following the lead of Lunar Prospector.

Using as a criterion what we’ll have to know to mount a human expedition to Europa’s ocean, the horse blinders of individual scientific investigators specializing in this or that mini scientific cubbyhole will be off. We won’t spend lot’s of money learning irrelevant things. What do we need to know? Here are some tasks that need to be done by orbiters and surface missions or rovers.

- orbital topography/altimetry and an ice bottom profile deduced from iceberg top/bottom ratios
- orbital chemical mapping, *Europa Prospector* ground truth probes
- orbital photometry - ice phases
- orbital detection of differential ice crust libration and oscillations vs. solid core sea bottom
- orbital “sniffing” of “transient phenomena”, e.g. outgassings, geysers, etc.
- orbital surveillance for fresh cracks,
- surface seismic network - aimed at mapping ice crust thickness; stations monitor radiation exposure variation
- Surface engineering tests
  - kind of ice easiest to melt thru, drill thru
  - kind of ice easiest to redeploy as shielding, e.g. over some inflatable hanger

#### **Robotic Portion of Manned Mission**

The following submarine robotic investigations can be carried out either before or in conjunction with a manned landing / submarine expedition. In the former case, a tethered sub-ice mother probe could send out a number of robotic submarine mini-probes reporting back by sonar to the mother probe. These could either have independent active propulsion or, leaving results to chance, be allowed to drift on whatever ocean currents there are.

- actual survey of ice crust underside topography
- identification of any gas/air pockets trapped in concavities in the ice crust underside.
- mappings of water pressures, salinity, dissolved gasses, currents, hot spots, ocean convection cells
- topographic map of ocean floor
- ocean bottom seismic net to map core layers
- thermal map of ocean floor

#### **A Manned Mission**

##### **Assumptions**

Jupiter space, inwards of Callisto, is filled with deadly radiation, that is, Io, Europa, and Ganymede, along with the lesser inner satellites (Amalthea and company) orbit the gas giant primary within its vastly stronger more deadly version of

Earth's Van Allen Belts. The success of the Galileo mission shows we know how to tackle the problem on the level of short duration robotic missions.

For human expeditions, the challenge is much greater and cannot be underestimated. There are those who have concluded man will never venture inwards from Callisto, the Mercury-sized outermost of Jupiter's mighty four, the Galilean moons known since 1610 and seen by countless millions in small amateur telescopes, even in good binoculars.

Providing material shielding against this radiation would add prohibitive amounts of mass to the manifest. For the purposes of our mission, we assume that it takes place in an era in which the engineering challenges of providing electromagnetic shielding have been mastered.

After a short debate, we assumed that we could land safely on the ice surface without sinking into a pool of fresh water melted by the descent rocket motors. We could use a bevy of smaller scattered rockets (an aerospike configuration?) or simply cut the motors just before touchdown.

On the ice crust surface, where on site material is available, a simple hanger can be erected to cover the base operations site. This could be done in modular fashion, by deploying an inflatable to be covered with shredded ice, which is then solidified into a self-sustaining igloo arch by micro-waves. The inflatable form can then be deflated and moved along the axis to shape the next section, and so on. The surface base modules, any fuel storage tanks, vehicles, and other equipment regularly manned or tended can be regularly housed under this hanger.



Ice-shielded surface base hanger: elevation (L), plan (R).

### Through the Ice Crust, Into the Ocean

At the prior (Duckon) workshop, we had discussed thermal melting of a shaft through the ice, using a vertical cabin cylinder of minimum cross-section with a heated (lower) prow cap. This vehicle might be about 10 feet or 3 meters in diameter or whatever the practical minimum. It could have spherical gimballed rooms that would be stacked one atop the other for the descent and fore and aft of one another horizontally for submarine excursion once through the ice. If a cable winch was employed, it would be best to have the winch reel aboard the descending submarine. That way neither continued descent nor communications would be interrupted if the melted water or slush slurry in the shaft above refroze, seizing the cable.

In the second (First Contact) workshop, we wondered if it might not be more efficient to equip our vertically deployed submarine vehicle with a drill head to create a shaft somewhat wider than the vehicle to allow the crushed ice slurry to pass alongside to the rear (above) the descent vehicle. We did not do any math at this time to have a basis for comparing the melt vs. drill methods for energy efficiency and progress speed. We were simply identifying concepts to put them on the table.

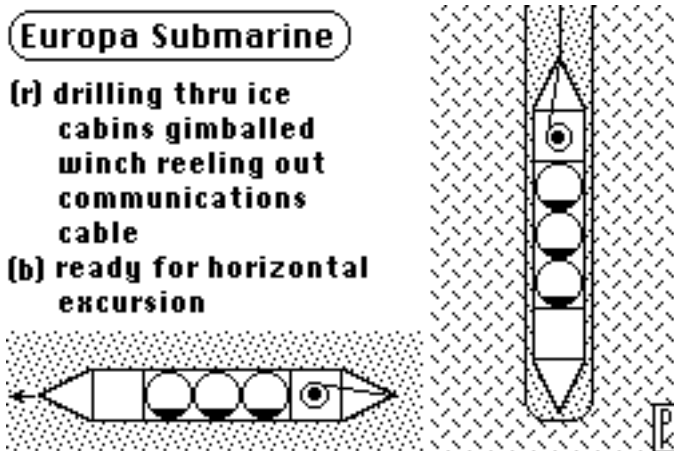

### Roaming Free in the Rhadamanthic Ocean

We imagined that upon breaking through to liquid ocean water, the sub would keep descending vertically, reeling out extra communications cable, until it was below the lowest downward protrusions of the ice crust in the area [see illustration, below]. At this point, an antenna would be affixed to the cable, and the cable cut below this point.

The submarine would then be free to roam through the Rhadamanthic, maintaining communications with the surface base by radio or sonar to the antenna suspended below the descent shaft. Joining the antenna at cable's end would be a beacon, to guide the submarine back to the point in the ice crust underside directly below the surface base.

We did not discuss means of ascent, but did wonder if the water/ice slurry in the shaft would not have refrozen in the meantime. In this eventuality, a new parallel escape shaft may have to be bored upwards when the crew's mission was done.

We briefly considered how the shaft might be kept open [percolated bubbles?] to allow routine travel between surface base camp and cable's end, a luxury feature that will probably wait for a second or later follow up manned mission. The writer (PK) personally thinks the ice is too plastic, the cold too intrusive — the hole would quickly freeze solid.

### The Submarine Mission

The intra-oceanic mission has already been outlined. It consists of undertaking the deployment of swimming, floating, and ocean bottom probes and science stations (see "Robotic Portion of Manned Mission" above). If an "easier" portion of this science chore list has already been done as part of an especially ambitious precursor robotic mission agenda, then the mission is to continue the work.

Inevitably, findings will pose new questions and if the manned vehicle is equipped to shed light on them, its mission may be expanded accordingly.

### Duration of the Manned Mission Size and Disposition of Personnel

The duration of the overall combined manned mission to Europa, and the division of crew between surface base and submarine vessel, should be figured backwards from the amount of work to be done and the location from which it is to be conducted. Simple as that. We determine the list of tasks to be accomplished, any necessary sequencing, any necessary time-sharing of equipment, and factor in the man-hours, travel

time, and crew talents needed in redundancy, toss in a healthy percentage of unassigned time (repairs, recreation, etc. - and then we can sit down and size up the mission. Europa is too far to go not to do the whole job that needs to be done on the first visit. This undertaking will surely dwarf the crew, equipment manifests, and costs of the first Martian Expedition.

### Now Just What If? Air, Down Below?

The writer (PK) had wondered if their might be ongoing volcanic outgassing from points along the ten million square miles of Europa's ocean bottom. If so, the likeliest major component would be carbon dioxide, CO<sub>2</sub>. If so, the ocean would become ever more carbonated (for as long as the volcanism continued) until a saturation point was reached. Beyond that point, free gas might build up in some / all of the concavities of the underside of the ice crust. The gas pressure would have to counterbalance the weight (in Europa's 1/7th Earth standard gravity) of the ice above. Possibly, from time to time the gas pressure would rupture the ice along weak fault lines and escape into space. Could this be at least a secondary source of ice crust fracturing?

There are a lot of ifs here, and the speculation that follows is far less "anchored" than I'd like it to be. Readers are encouraged to give their input, whether constructive or show-stopping, and on that basis we'll decide whether continuing brainstorming along the lines that follow should be part of the final workshop in this series, at ISDC '98 next May.

Mentioning all this to my workshop mates, it excited their imaginations, sending them into overdrive. Are such "air" pockets over lagoon like calm ocean surfaces common? How big can they get in area (air-exposed water surface) and volume (air)? How oppressive will be the air pressure? Something that divers on Earth have managed in pressure-equalized sea floor habitats? If there are no naturally occurring gas pocket/lagoons, can we create them by electrolysis of the ice? How stable would they be in either case? And in such high pressures, might not the freezing point be on the balmy side? in the 50's?

There is a tradeoff: higher temperatures come with greater pressures. lower with less. We can live with 32° so minimum depth below surface = minimum thickness of ice overburden = lowest atmospheric pressures = the best situation, all else (size/surface/ volume) being equal.

Pitch dark, they could be lit. We could put together a floating outpost in such a pocket, even equipping it with a pressurized dome so the staff could look out on the "cavern" roof and the "lagoon". We could use water heat pumps to maintain interior comfortable conditions through diurnal and seasonal changes, effecting "weather-like" cycles. In these lagoons, we might do high CO<sub>2</sub> agriculture on floating platforms, growing some food on the spot. Maybe mini OTEC installations could supply ample power.

Proximity to ocean floor thermal vents could be strategically important. Two possibilities: (1) gas saturation is homogeneous - there might be a real "sea level" above which there are always gas pockets. But what happens if one is breached and vented? (2) if there are pronounced oceanic convection cells, gas saturation may vary accordingly, and "sea" levels may be local or nonexistent.

What is the global distribution of such coves? Are

there any clusters of fair sized anchorages? Are there gas pockets large enough to host sizable floating settlements? Cities? If so, such clusters might be where a European civilization to be should make its beachhead. Individual outposts could be named after classical harbors of old: New Syracuse, New Carthage, New Tyre, New Alexandria, New Atlantis, and so on.

A big whoa! Are their enough dissolved metal salts in the Rhadamanthic to allow for advanced extraction processing of building and manufacturing materials so that this European adventure might become an overture to a very unique European settle-ment and civilization? And if there are deep ocean floor hot vents such as host oases of Earth life not dependent on chlorophyll or sunshine, then aqua culture is possible. If they exist but are lifeless, they could be seeded with specimens from Earth.

How would one transit between coves? By submarine, or by shafts to the surface and transfer to suborbital surface hoppers? When anchorages are close by one another or clustered might man-made tunnels above "sea level" work?

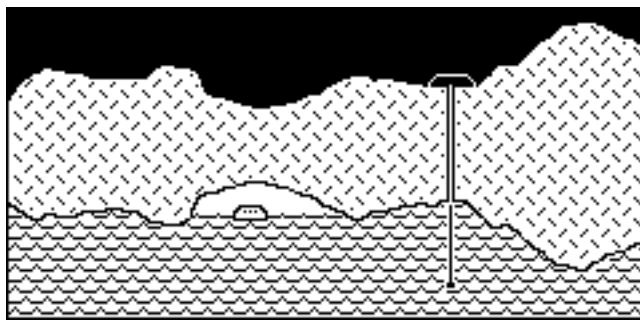

Could Europa, rather than boring Callisto, become the major human population center of Jove Space, with active trade to the other Galilean moons? Maybe there are no such places, and all we have done is to provide science fiction writers with a new class of venues for their stories. <MCW>

### Structure of the Europa III Workshop

at ISDC '98 in Milwaukee, WI, May 22nd thru 25th

Depending on the number of participants, after a general introduction, the Workshop will break up into the following groups, according to individual interest, hopefully at least five per group.

- a. Precursor Mission Homework: number of probes, missions, etc.; mission sequencing, design constraints, suggestions
- b. Manned Surface Base and shaft, drilling means
- c. Manned Submarine mission, probes, excursions
- d. (New Atlantis outpost-settlement)
- e. (A European Economy, Trade interdependencies)



# APPENDIX

from MMM #108 SEP '97

## **Plant-Only Diets** **for Space Pioneers:** **The Good News**

Louise Rachel (Quigley), L.R.S. - Special to MMM

Stan Love's excellent short concept paper about the near-impossibility of having food animals in near-term space habitats [MMM # 107 JUL '97, p. 10.] cries out for reply. For he has clearly worked out by pure logic the necessity for astronauts to adopt "vegan" (plant-food only i.e. no eggs or dairy products, a stricter regime than the more common "vegetarian" or simply meat-free) diets without actually having any personal acquaintance with such diets himself.

### **We can survive on a vegan diet**

If he were a vegan, or well acquainted with some, he would know that with only one tiny exception, *100% of human dietary needs can be easily filled by a plant-foods only diet*, not 97% as he believes. The exception is vitamin B-12, which is produced by bacterial fermentation. Animal-product-eaters get some from the B-12 that ruminants have stored, while vegans use supplements derived from non-animal bacterial processes. Other than that, every nutrient needed by humans - including pregnant women, fetuses, and breast fed babies - is readily available from plants.

Complex carbohydrates (and associated fiber) are of course supplied in abundance by every whole grain, bean, pea, vegetable, and fruit you can imagine. Fruits and honey provide simple carbs, if you want them (bees may be needed in colonies to provide yield-increasing pollination).

Proteins and amino acids are present in whole grains, legumes, nuts, seeds, and many vegetables (especially dark green leafies, crucifers, and root vegetables); fruits are actually the only low-protein plant food. Each different plant provides a different mix of amino acids; it is now well established that anyone who satisfies caloric needs by eating a variety of different whole plant foods during the course of each day will get all the protein s/he needs. Combining different plant protein sources in a dish is not necessary as long as daily variety is assured and no amino acid will be lacking. The only potential catch is that whole grains have far more protein than refined flours - but astronauts and space colonists would not have leeway to waste the bran and germ by refining their flours anyway!

Fats and oils are of course also available from plants: corn oil, olive oil, safflower oil, wheat germ oil, nuts and seeds and their butters and oils, avocado, etc.

And all minerals and vitamins (except B-12) are present in plants as well; in fact, vegetables and fruits are the primary sources of most of them. Iron is plentiful not only in meats but also in dark green leafy vegetables and many

legumes. Calcium, usually associated with dairy, is available to humans from the same place the cow got it: whole grains and leafy greens. And if you're not eating animal foods, you absorb and retain dietary calcium so much better than if you're carnivorous that you will not need nearly as much. Short-term astronauts can take B-12 supplements with them. Long-duration space colonies will have no trouble making B-12 for themselves: the necessary bacteria take up very little space, and using them is an off-the-shelf technology.

In short, all dietary needs for human health can easily be met by growing a well-chosen variety of plants as part of the space habitat life support system. Animal foods are utterly unnecessary.

### **A vegan diet can be satisfying**

The real question for astronauts and space colonists therefore will not be "can we survive on a vegan diet?" but rather, "will such a life be worth living?" It will be hard for some to believe that the answer is and unqualified YES.

Here, let me digress into personal history. In early 1990, when I was an omnivore (eating both plant and animal foods), I met and married a vegan. Within a few months, my 11-year old announced she would never eat anything with a face again. So although I had never formally renounced meat myself, I found myself cooking for and eating with vegetarians, and with most meals vegan, on a permanent basis.

Several results surprised me. First, when my meat-eating dropped below once a week, I started losing my taste for meat: I would order meat in a restaurant and not enjoy it in the way I remembered. After a while, I stopped ordering it. Second, I didn't miss it. By then, I had discovered the many worlds of vegan cuisine: traditional Chinese, Indian, Mexican, Middle Eastern, and many other traditional peasant foods from all over the Earth to provide inexhaustible variety of dishes and seasonings.

You can eat vegan forever and not get bored, especially since many of the tastes we associate with a given meat food derives in fact from the spices and not the meats: the taste of tomato sauce comes not from the shipmate but from the oregano and basil, for example, and rosemary-roasted potatoes give you the same pleasure as rosemary-roasted lamb.

Third, I discovered only after I had eaten this way for a while that I did not get weak and puny when I ate plant foods only, and gave up trying to balance proteins in each meal. On the contrary, in fact, I get fewer colds and have a lot more energy, and since I've gotten more physically active over the last seven years, I've gotten more muscular and vigorous on the vegetarian diet than I ever was as a carnivore.

I don't think average Americans can believe that eating any reasonable variety of whole plant foods, without paying attention to their different amino acids, really can give a person what one needs, *unless and until one makes the experiment*. It did take me a while to work my way into this regimen and get comfortable with it, but the proof lies in my and my husband's continuing health - he's been eating this way since '82. Proteins are adequately supplied by plants, and without doing a "balancing act".

## ***Enter meat-substitutes***

The other good news is in a sense more recent. After all, some humans have eaten a vegan diet out of necessity or conviction (spiritual or other) for thousands of years. But foods specifically intended as meat substitutes are extremely new arrivals on the food scene, and have been developed only in the last few years as more and more individuals began experimenting with giving up meat for reasons of health or kindness to animals or environmental concern or social justice. Many of these people have chosen not to actually eat animals, yet they did not want to lose the pleasure they associated with animal foods. As a result, a whole meat substitute industry is now also an off-the-shelf technology, and has matured rapidly to the point where some of it is awfully good.

Taste and experimentation do certainly play a part: I myself have not yet found a non-meat hot dog that I like, for example, though I adore a couple of different soy-product burgers. But many substitute meats are absolutely delicious in themselves, and many are difficult or impossible to tell from the real thing. [Most of us, I dare say, have eaten soy-product bacon bits (on salads, baked potatoes, etc.) with satisfaction for years. — Ed.] Granted that the best results are so far found in dishes such as sloppy joes, spaghetti sauce, marinated kabobs, and so on rather than as fake steaks.

The existence of these products means that space colonists will even have meat-substitute choices that are thoroughly palatable and hard to tell from the real meats they have left behind. Some will probably eventually abandon the meat substitutes, while others will depend on them. Both these camps will enjoy their meals.

Stan Love concludes that astronauts (and early space colonists) “will be largely vegetarian, in spite of any personal preferences.” That sounds dire, and it doesn’t have to be. They surely will probably be vegetarian - vegan, in fact. Yet they will be as well and happily and deliciously and healthily and variously fed as any humans on Earth. <LRQ>

### ***Editor's Postscripts (1) "cultured meats"***

One of the things that has long seemed possible to me is a (moral, if you will) compromise, in which we learn to cultivate real animal tissues (chicken breast, beef liver, beef, pork, etc. etc.) in nutrient-fed vats. The result would be real meat without the animal, “without the face”, except that of the ancestral donor. How satisfying this would be, or how economical from a food-production point of view, I do not know. But it offers a third choice for those who realize the high costs of meat production but do not want to give up their meat.

Biosphere II required seven acres to provide a sparse vegan diet for a handful of people. A space biosphere that insisted on supplying meat, even from the more efficient sources as chicken, rabbit, cavy (guinea pig, a Peruvian meat staple) and fish would need to be many times more spacious. We may want meat, but it will be a definite and pricey luxury.

### ***(2) 125 JSDC '98 attendees try it***

Louise Rachel Quigley & Hyatt Regency Milwaukee Chefs put together a space frontier vegetarian luncheon for Saturday noon with Al Binder speaking. It was a hit!

## **PARTICIPANT BIOGRAPHIES**

### **Seattle Lunar Group Studies - SLuGS**

[Concept Papers printed in MMMs # 106, 107, 108]  
{Pages 41-45, 48-52, 57-60 this volume of MMM Classics}

There are many members of SLuGS. Not every member participates in every project. It is SLuGS policy to encourage the formation of small working groups within the overall organization so that multiple research projects can be undertaken simultaneously. Brief biographical information on the SLuGS members participating on this 1990 project is given below. The entries are in alphabetical order and reflect information current as of 1991.

**David D. Graham** is president of Woolly Mammoth Co./ECS of Seattle, Washington. Mr. Graham provides general business consulting for construction contractors, alternative dispute resolution services for contractors with government contracts, and develops specialized software for the computer industry. Mr. Graham has an extensive background in commercial and military facilities construction. His experience includes service as Project Manager, Project Engineer, Contractor Quality Control Representative, and Claims Negotiator.

**Joseph P. Hopkins, Jr.** is a Senior Simulation Engineer for Boeing Commercial Airplane Company in Seattle, WA. He received his Computer Science B.S. in 1976 from the University of Missouri at Rolla. He has worked in the Flight Simulation Center for most of the past decade providing simulation support for avionics and display systems on many different Boeing jets. In 1984 he supported the successful Boeing space station bid. He is a past Vice President of the L5 Society, served as the Chairman of the 1986 Space Development Conference, and [1990] as SLuGS Vice-Pres. He enjoys backpacking, Nordic & Alpine skiing, classical music, reading and brewing beer.

**Stan Love** is a graduate student in the Ph.D. program of the Astronomy Department at the University of Washington in Seattle. He received his Bachelor's in Physics from Harvey Mudd College in Claremont, CA, in 1987. His primary research area is the astronomy, geology, and physics of the solar system. He also pursues research in Aeronautical and Astronautical Engineering. Mr. Love is currently serving as an Officer-at-large on the Board of Directors of SLuGS. Recreational interests: hiking, rock climbing, dancing, boating, reading, role-playing game design.

**Rodney Kendrick** is a Stress and Fatigue Analyst with the Boeing Military Airplane Company. For the last five years, Rodney has been working on the B-2 program testing and analyzing the performance of the first large all composite aircraft. Rodney has had a long interest in composite structures and their reaction to stress. His graduate thesis at the University of Texas (Austin) is titled "Hypervelocity Impact of Graphite Epoxy Panels."

**Robert Lilly** is an Electrical Engineer for Boeing Commercial Aircraft in Seattle. Mr. Lilly worked for two years on the 747-400 program before transferring to the 777 program. His major interests in addition to aerospace are flying and scuba diving. Mr. Lilly served as SLuGS president for 1989 and presented the groups paper "Comparing Structural Metals for Large

Lunar Bases" at the Space 90 Conference in Albuquerque, NM.

**Dana G. Andrews** is currently the Single Stage to Orbit (SSTO) Program Manager at Boeing Aerospace Company. Dr. Andrews (Stanford, 1974) has a long history with the various divisions of Boeing. He previously served as Program Manager for the Personnel Launch Systems program, as Aerodynamics Technology manager for Boeing Aerospace & Electronics, as Flight Technologies Manager for the Advanced Launch System program, as Space Station Habitation Module Manager at Boeing Huntsville, and various management roles in the Orbit Transfer Vehicle studies and the Air Launched Sortie Vehicle studies. Dr. Andrews has also worked at Boeing Commercial Airplane Company in the Preliminary Design section and in various research and development project with that division.

**Gordon R. Woodcock** is a manager of Space Transfer Vehicles for Lunar/Mars Missions for Boeing Aerospace in Huntsville, Alabama. He received his B.S. in Aeronautic Engineering from Oregon State University in 1954 and his M.S. in Nuclear Engineering from the University of Washington in 1965. He has served on the Board of the L5 Society (now the National Space Society) since the late 1970's. He was President of the L5 Society from 1984 to 1987. Mr. Woodcock was also a founder of the Seattle L5 Society in 1976.

In his work at Boeing he has been a study manager for Future Space Transportation Systems, Solar Power Satellites, and space stations. He has written numerous articles and papers on space development and authored a book "Space Stations and Platforms" published in 1986. In addition to his interest in "high technology," Mr. Woodcock competes in 10K foot races and has run three marathons.

**Dean Calahan** is a programmer for Aldus Corporation, Seattle, WA. At Aldus, Mr. Calahan is responsible for testing and fine tuning new software. Additionally, Mr. Calahan's interests include research into fractal geometry, hiking the Pacific Northwest, and a continuing program of quality assurance sampling of regional malt beverages.

**Mark Lawler** is a graduate student in the Ph.D. program of the Astronomy Department at the University of Washington in Seattle, Washington. He received his B.S. in Mechanical Engineering from Colorado State University in 1979, and his M.S. in Mechanical Engineering from Stanford University, California. He was a Fulbright scholar in 1980 to 1981 and attended the University of Stuttgart, Germany. In the early 1980's he worked for Boeing Aerospace on satellite flight controls and the 1984 Boeing space station bid. He is an avid backpacker, cross country skier, and bicyclist. Currently, Mr. Lawler is active in efforts to preserve ancient forests in the Pacific Northwest.

**Kent Karnofski** has a Bachelor of Science degree in Mathematical Sciences from the University of Washington in Seattle. He is presently working on Propulsion Controls with the Boeing Commercial Airplane Group. Kent has worked on several diverse projects within the company as a software analyst/ developer. His main interests in space are life-support systems, human factors, and alternative energy sources.

Leisure time activities include music, dancing, reading, hiking, and bicycling.

**Jeff Klien** - no information

**Hugh Kelso** is an architect with ABI, Inc. in Seattle, WA. Mr. Kelso has twenty years experience in construction and architecture including various heavy construction jobs (dams, transit tunnels, hurricane barriers). Mr. Kelso has also been responsible for the design and management of numerous residential and light commercial projects. Mr. Kelso is a co-founder of SLuGS and co-authored recent SLuGS papers on the design of large habitat structures on the Moon.

**Mike Anderson** - no information

**Brian Tillotson** is an engineer in Boeing Aerospace's Advanced Civil Space group in Huntsville, Alabama. Dr. Tillotson leads a project to find and evaluate innovative ideas for planetary surface systems. He is involved in advanced (some say bizarre) space propulsion research and research in artificial intelligence. Dr. Tillotson's Ph.D. research at the University of Washington enabled a robot to learn from experience. Research into artificial intelligence and neural networks remains an active interest.

Dr. Tillotson cofounded Space Research Associates, Inc., where he worked on solar power satellite concepts. He relaxes by reading, hiking, or playing paintball. <SLuGS>

## *A Plethora of Asteroid Moonlets To What Use can we put them?*

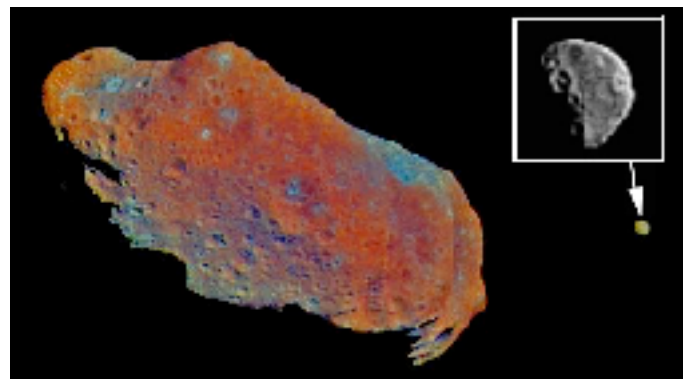

ABOVE: Family portrait of 53 km. long **Ida** and 1 km astrobit **Dactyl**. In last month's MM REVIEW, pp. 7-9, appeared an article about a second such discovery, a tiny moonlet around near-Earth asteroid **Dionysius**,

There may be many hundreds more! Are they merely astro-geographic curiosities?; navigational hazards?; or future bonanzas, their individual case by case usefulness up to men of opportunity to uncover?

[More than 30 asteroid moonlets had been discovered as of October 2002. #90 Antiope seems to be a pair of twin asteroids orbiting one another. Other asteroid moonlets are diminutive.]

Send your (or chapter discussion group) thoughts and brainstorm to MMM <KokhMMM@aol.com>

