

"Expanding the Human Economy through Off-Planet Resources"

MOON MINERS' MANIFESTO - Pleiades

MMM Classics
The First Ten Years

Year 10: MMM #s 91-100
December 1995 - November 1996

This year, we continue our series on Starting over on the Moon, now progressing from the first beachhead outpost to early frontier settlements.

*in the (new) beginning, ...
(Starting over on the Moon)*

Life on the Early Lunar Frontier will not be an easy one, but it is a chance to get in on the ground floor, to help create the rules and conditions, to get a personal fresh start. We look at lots of topics: start up industries; expanding the outpost; moonbase personnel; pioneer holidays; effects of 'one-sixth gravity; the effects of cosmic rays, ultra violet, solar flares; the natural mutual quarantine of lunar outpost; dealing with the element deficiencies on the Moon; the Moon's regolith blanket as an analog of Earth's air blanket; a moon calendar for scheduling lunar activities; the unending vigilance for fresh air; abundant plant life as a security blanket; spacesuit aversion; the quest for elbowroom; the small market syndrome and the quest for variety; how, for generations, luna will remain a frontier. That's a lot to talk about!



In MMM #97, we take up the topic of **Spirituality on the Space frontier**. the lunar environment will have its effects on spirituality and on the reinforcement of personal religious sensitivity. This is a fascinating topic which has received little consideration elsewhere.

We have previously talked about sports on the Moon, but 1996 was the year of the Atlanta Olympics. Would the Olympics ever include events on the Moon? In addition to the main summer and winter Olympic venues, would their ever be an expansion to include world-class athletic competitions beyond Earth? This is our topic in MMM #98.

2046 Olympics The Space Games



* moon icon © Simon Rowland



We look at possible events on the Moon, as well as events in Earth orbit and in free space. It is an interesting and exciting topic. What would it be like in 2046? We choose that year, rather than 2044 or 2048 when the main *terrestrial* Summer Games would be held, thinking that the even year in between would be ideal for the Space Games. We trust you will enjoy speculating with us.

Lavatubes on the Moon open up a whole world of possibilities that one doesn't see just contemplating the surface rubble pile! We have visited the topic often in MMM, and we devote a whole issue to this fascinating subject in MMM #100.



Twelve Questions about Lunar Lavatubes; their Remote Mapping and Robotic Exploration; Settling into a Lavatube, the (Sub)Terraforming Challenges; and Naming Lavatube Settlements are topics covered.

A hefty issue

This issue of MMM Classics is unusually long, 96 pages! This was MMM's first year serving the members of Artemis Society International, and apparently, that had some stimulating effect on our brainstorming and output. - **Editor**

Calling all wordsmiths! We need to coin a word.

Here on Earth, we throw a ball “into the air”. You could do and say the same on Mars. But what about on the Moon? No air! And to say you threw it into space or into the vacuum or into the void would be ambiguous, if not misleading. These words refer not to the boundary volume just above the surface (as does “air”) but to the endless emptiness that goes on and on, up and out.

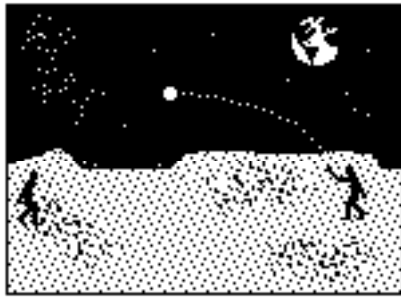

Send your suggestions to the MMM submission address (not the LRS PO Box) or to KokhMMM@aol.com and, to the person whose suggestion we like best, in addition to 15 minutes of Warholian fame, we will send a copy of the Collected Major Articles from MMM, issues # 1-20.

From the MMM Dictionary 

Entry — “Space Activist”

“Anyone who uses his or her talents to the best of his or her ability to promote and hasten the realization of an *open* space frontier.”

This means anything! - as a writer of general or textbook nonfiction, or of hard science fiction, screen plays, poetry, even “filk” songs; as an editor, publisher, bookseller; as a speaker or event organizer or exhibitor; as a teacher or curriculum planner; as an artist or model maker; as an actor, director, or producer; as a merchant; as an engineer, chemist, researcher in biospherics or experimental agriculture or as a space architect; as an entrepreneur or venture capitalist; as a lawyer. All these roles, and *many more faceless support tasks*, are the essence of either of *public outreach in depth*, or of *laying concrete foundations*, or both.

There are far more *menu options* than those amongst us concerned only with political action would have us believe. We are *more than letter and check writers*, more than phone dialers. **We are the people who would move off planet out onto the space frontier.** We do it *best by each* doing our own thing as well as we can, *not* by doing *solely* what someone else would have us do to pursue some *smaller* vision.

Entry — “Open” Space Frontier

“A future in which people of all walks of life have access to, and live, work, and play in various settings off Earth.”

The NSS Mission Statement reads: “to promote change in social, technical, economic, and political conditions *to advance the day when people will live and work*

in space, through public education, political and local chapter activism, and the publication of the bimonthly *Ad Astra Magazine*.”

The NSS “Mission-centered goal: by 2010: human settlement in space with 25 people, launch costs under \$50/lb to orbit, and space-generated revenues of \$60 billion.”

This reflects crucial influence of former L5 Society members who chose to stay on board at the time of the L5 - National Space Institute merger in 1987 which created NSS.

As NSS *seems overtly preoccupied with reacting* to one crisis after another in which political pressures would erode the current socialized space program (in the direction of *no* program at all) it might seem to the unfamiliar outside observer that NSS’ sole purpose is to promote the continuance of the government’s “closed” frontier policy (“astronauts only, government outposts only, scientific activities only”) in effect since the dawn of the Space Age with *Sputnik* in 1957. The NSS Board, however, is *firmly on record in support* of an “open” frontier. Given its preoccupation, however, it is clear that the rest of us must work that much harder at strategies that *Open the Frontier – outside NSS, if need be.*

Entry — “Commercial Space”

“any for-profit endeavor or enterprise which increases the amount, scope, feasibility, and/or sustainable economic viability of robotic and/or human presence in Earth orbit and beyond.”

One might get the idea from many space activists that commercial space means private launch companies and small satellite manufacturers - *only!* Even if this is qualified with an “at this stage of the game” this short list betrays a troubling lack of imagination, coming as it does, *from people who say they want to live somewhere other than on Earth!*

While it may be easier, and safer, to restrict one’s ambitions to the “toy space” of microsats and small launchers, our goal is to create a self-sustaining human economy beyond Earth’s atmosphere. This clearly requires **commercial entry into man-rated rockets and habitat hardware.** This has already begun. The for-profit SpaceHab shuttle payload bay module is already a reality, but has faced a rocky road.

Early plans for commercial tourist modules were ill-fated because they depended either on paper study spacecraft, or upon the government owned shuttle. Any effort to piggyback commercial for-profit activity on profit-be-damned agency programs is at the mercy of political pressures and bureaucratic procedures — hardly a place to put dearly acquired capital.

Many put all their hopes on the X-33 program. But the dream of **Cheap Access** from NASA seems troublingly self-deceptive. Meanwhile, would-be commercial players stall.

We clearly need **commercial manned access** to space. Yet the very presence of the shuttle system works in a highly preemptive manner to prevent such access from materializing. What is needed is to tie in with a **commercial manned destination:** a commercial space station. With the adoption for the International Space Station Alpha of the high inclination orbit favored by the Russians, there has never been

more reason than now for an alternative, a commercial station-depot *in a low inclination orbit* vastly superior as a staging and refueling place for deep space missions. Alpha would serve Moon and Mars missions at a severe handicap in comparison. There will also be need in orbit for more lab space at commercial disposal than ISSA can or will provide.

We also need to dust off the “**Space Cartage Act**” proposed many years ago whereby anything once in orbit and without its own motive power, could be moved to another space location or orbit *only by a commercial vehicle*.

Yet there is another kind of entrepreneurial activity which has the potential to accelerate the realization of an open space frontier. It is *not at the mercy* of bureaucratic, administrative, or congressional whim. Why not? Simply because it is a path that does not threaten powerful vested interests. We are talking about “**spin up**” **research & development**.

“Spin up” works like this. The entrepreneur considers the many and varied technologies that will someday be needed on the space frontier. Next he/she considers what profitable terrestrial applications there may be for each of these. There follows a business plan, and ultimately a for-profit terrestrial enterprise which has the happy effect of pre-developing and debugging and putting “on the shelf” a technology which will one day help open the frontier - *sooner and at less cost*.

[Continuing a New MMM Series]

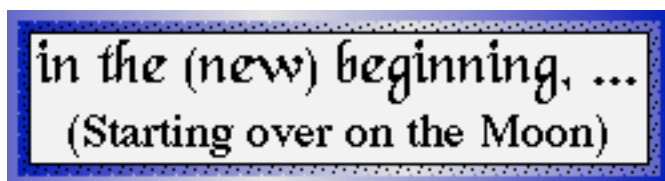

This month, we look at what the first lunar industries might include. As is clear from examining just what operations will be necessary simply to set up a lunar outpost properly, we will have to take the industrial plunge from landfall day one.

Then we look at how we can expand the starter base into something more fully functional, something more clearly pregnant with the future. The needs and methods of outpost expansion will also greatly affect the route infant lunar industries take by way of diversification.

Finally, we come to the question of personnel. There is a chasm of difference between crews on scene for short limited tours of duty, and people come to “settle in”, presumably for the rest of their lives. How do we go from one paradigm to the other?

“Space” —
it’s up to all of us!



by Peter Kokh

The **first** industrial equipment to make landfall on the Moon **will not be** a small pilot demonstration plant to make the first exportable product (**oxygen** from moon rock, being the popular candidate). *Rather it will be equipment needed to set up the lunar outpost properly in the first place*. This means equipment to make sintered regolith blocks to use in directly- or indirectly applied shielding [e.g. hangar sheds. cf. MMM # 89, October 1995, “SHELTER” pp. 3-4], and possibly solar concentrators and molds to make cast basalt products such as paving blocks for dust control [cf. “DUST CONTROL” in the same issue, pp. 5-6 - both republished in MMM Classics #9]

Any kind of construction and/or industrial activity will require soil handling equipment. *IF this equipment is properly engineered*, it can, at the same time, *providentially* separate out iron-rich materials (by passing over the soil being handled with a magnet) and solar-wind-derived gasses and other volatiles adsorbed to the fine soil particles - such as hydrogen, helium, neon, argon, xenon, carbon, and nitrogen (by heating). This process we have dubbed “primage” [cf. MMM # 38 SEP ‘90, page 4]. Every scoopful of regolith we move with cheaper equipment not so designed represents a lost opportunity to set ourselves up for subsequent industrial activity, in a sort of sinful shortsightedness on a par with our current policy of throwing away the space shuttle external tank.

Mark these words: if, through political shortsightedness in a government effort, or through misguided accounting decisions or scheduling impatience in a commercial effort, the first soil moving equipment on the Moon is *not* “equipped to primage”, we will have set ourselves in an ever self-deepening rut to nowhere. *Impatience always backfires* - its a cosmic law.

If we are providential enough to so set ourselves up, among the first products of hit-the-ground running industries will be bins or bowls, and tankage, in which to keep separate such industrially handy scavenged materials. We may also want to harvest, and “embin” the less common differently enriched regolith soils wherever we find them relatively unmixed. These will include (in addition to the common aluminum and calcium enriched highland soils and the iron and titanium enriched mare soils - both handy to a “coastal” site) the so-called KREEP soils from the Mare Imbrium impact splashout enriched in Potassium, Rare Earth Elements, and Phosphorus; iron-enriched orange soils like that found at Shorty crater; iron and titanium enriched ilmenite soils; material from large crater central peaks, probably representing upthrusts of deep mantle material.; and the glassy spherules found everywhere.

Initial “Industrial” Equipment

We’ll want a bulldozer/grader fully equipped to

by Peter Kokh

primage, a solar concentrator able to produce various levels of heat, various handy molds, some of them refractory (able to withstand high heat), and sieving and compacting devices. We'll also want a lab capable of testing performance characteristics, and a shop with in which we can "work" these initial crude materials, and "fabricate" them into useful items: building blocks and bricks, paving slabs, bins and other containers, tankage, additional molds, support "tables" for additional imported equipment, etc. As soon as feasible, we will want equipment that will let us tinker with sintered and cast iron and crude glass products.

Yes, we want to set out a ready-to-go-just plug-in oxygen extraction pilot/demonstration module. But if we come truly committed from the outset to a permanent industrial presence, then the oxygen trick, taken alone, buys us little. Oxygen is important enough to share top priority status. Delivered back to LEO for refueling Moonbound ferries, it will lower the cost of importing additional equipment to the Moon. But every needed piece of low performance equipment that can be made on the Moon in a simple starter industry also cuts down import costs, even more directly, by cutting down appreciably the total accumulative weight of equipment needing to be imported. We need this two-pronged approach. To scorn it, as unworthy of attention, would be, to put it honestly, just plain fatally stupid.

Beyond that, we must always keep in mind, that anything the outpost can make for itself, however crude - as long as it is serviceable, is a potential export to other space locations at a decided cost-advantage over unnecessarily refined alternatives made within, and shipped out of Earth's deep gravity well. This should be the guiding philosophy of lunar industrial diversification aimed at a healthy diversified export trade.

A companion stratagem that will "set us up" better yet is to especially fabricate all equipment that does, and must initially, come up from Earth so that those components which can *eventually* be replaced by serviceable Moon-made parts are made of elements not easily or economically produced on the Moon, at least not in the near future, *but which* will be essential for a healthy diversified industrial operation. For example, tables, tanks, bins, dividers, separators, containers and other packaging materials etc. *should* be made of *strategic cannibalizable materials* such as copper, brass, stainless steel, aluminum alloy, easily reusable simple polymers like polyethylene and polyurethane, etc. [cf. MMM # 65 MAY '93 pp. 7-8, "MUS/cle Substitutions" and "Stowaway Imports" - MMM Classics #7]

While such "special" manufacturing specifications may make the import item initially more expensive in itself, and perhaps even heavier and therefore more fuel-costly to import, the subsequent advantage to infant lunar industry may very well outweigh these upfront penalties. *If we are indeed in this for the long haul, then long term goals must be given priority over short-term budgeting myopia.*

To insure that this is the plan we will indeed follow, it is absolutely essential that we first sell ourselves, then others whose support we will need, on the whole "ladder" of a lunar industrial settlement, and not just one innocuous unalarming "rung" at a time. The rung-by-rung sales pitch now in vogue among space-activists is perhaps the single most responsible fatal flaw behind our current going-nowhere space efforts. ☒

The provident architect, in designing a building - be it a residence, a factory, a school, an office, or a corporate headquarters - will take into consideration the possible downrange need to expand. For if the tenant of the premises prospers, the structured interior space of the original construction may soon be outgrown. If no provision has been made for easy and orderly expansion, the original site may have to be abandoned, and a new facility built on adjoining or distant property.

Much like the would-be architect using Lincoln Logs or Lego blocks, and even more like the think-ahead Scrabble player, the architect of the original lunar outpost will want to leave a number of opportunities for expansion. His grounded options must provide for changing needs in a flexible way. "Expand EZ" features will mean minimum disruption and disturbance of, and other inconvenience to, ongoing operations

This is the philosophy behind using multi-port nodes as airlock modules, for example. We don't have to give up a point of access to expand. Spacing of such expansion/access nodes must also be considered. The module or other pressurized space to be added may or may not be of comparable size to the starter module or modules. If connecting ports are arranged at angles to one another, as for example in a cross-T, hex, octagonal or other radial pattern, this provides more sizing flexibility than does an initial configuration with expansion ports arrayed side by side.

Expansion ports should be indifferent to the nature of the added space: hard-hulled payload bay sized modules brought up from Earth; "telescoping" or otherwise unfolding hard-hull modules which allow more usable volume; or inflatable structures. Of these, the cylinder can offer the same or greater volume than the sphere for the same or lower height. And the torus offers a more stable footprint as well as room for built-in features in its "donut-hole" [cf. MMM # 50, NOV '91, pp. 6-8 "Hostels: Lowering the Threshold to Lunar Occupancy: Part IV, Hostel-Appropriate Architectures" - MMM C #5]

We have recently touched on another topic which will greatly affect the ease or difficulty of outpost expansion: the manner in which we apply shielding mass made of regolith. If we apply it directly, a certain amount of tedious, gingerly delicate, and messy excavation may be necessary to expose the expansion point decided upon. If we apply our shielding indirectly, as in a hangar shed arch roof over the outpost site, then this shielding will not be in our way when we need to expand, and, as a bonus, the workers affecting the expansion can work in a safer, radiation and micrometeorite free "lee" vacuum under the hangar shed.

The layout of the site must also be considered, and we won't want to pick a site that unduly constricts opportunities for expansion with too close scenic but in-the-way features like crater walls, rille shoulders, scarps, etc.

Expansion for what?

We will want to expand our outpost in a timely fashion to provide together both more living space and more operations space. In expanded living space will be additional

PERSONNEL

From Scout Crews to Pioneer Settlers

Expanding “tours of duty”, “reenlistment” options, partners & pregnancies, cabin fever prevention, etc.

by Peter Kokh

Expectations from our long-running experiences on Mir should give us confidence for similar manning and crew rotation patterns on the Moon. In its one-sixth Earth-normal gravity (“sixthweight”), any physiological deterioration should both proceed more slowly and be accumulatively less severe than in ambient zero-G. In following this pattern, we might expect some lunar base personnel to have longer tours of duty, while other visiting “mission specialists” who have come to oversee relatively short tests of pilot demonstration processing equipment, for example, may return to Earth in short order.

There are several reasons why personnel may rotate at a slower rate than the rhythm of Earth-Moon support and resupply flights might seem to allow:

(1) not bringing replacement personnel frees up allowable net payload mass for extra badly needed equipment.

(2) not returning personnel makes room for extra “export” cargo from the Moon:

(a) lunar liquid oxygen for delivery to LEO to refuel the Earth-Moon ferry

(b) loads of regolith samples for delivery to Earth’s surface where ongoing processing experiments can be done more cheaply and more thoroughly, i.e. with lower gross man-hour support costs and in better equipped laboratories.

(3) if the lunar descent vehicle is built as we’ve suggested, with the crew cabin underslung and equipped with a surface locomotion chassis that can be winched to the surface and taxi to the outpost [“frog” and “toad” “amphibious” lunar landers are introduced in MMM # 48 SEP ‘91, pp. 4-6 “HOSTELS: Lowering the Threshold for Lunar Occupancy”, Part I - MMM Classics #5] every descent module that returns crewless means an extra surface vehicle at the disposal of the outpost.

(4) In general, average on-the-Moon labor support costs will come down as the amount of productive man-hours per ticket of passage goes up.

With all these forces operating to encourage extension of lunar surface duty times, outpost managers, both on site and on Earth, will be motivated to provide perks and incentives for voluntary extension of planned tours of duty. Moon duty will be exciting and prestigious at first, with no shortage of volunteers. But as duty time wears on, the view out the window less dominated by Earth, more by sterile, barren, unforgiving, and lonely moonscapes of colorless grays, lunar base personnel will be glad to get out of their sardine can quarters, be relieved of their cabin fever, and return “home”.

From this humble beginning to an era when men and women will come intent upon staying the rest of their lives is one tremendous jump. But the long road from limited mission scouts to pioneer settlers starts right here, with the need on the several counts mentioned above to *encourage* voluntary, but still not indefinite, extensions of contracted duty time.

People put up with what they have to. If the next

private quarters for more crew, more and better furnished common space, more recreational and leisure space, more space for added life support and food production, even garden space.

Expanded operations will include: exploration and in-the-field prospecting, mining, material production, manufacturing, expanded sample and product testing laboratory, product fabrication facilities, inside storage, etc. Obviously, reason exists for considerable expansion, stage by stage.

Planning for expansion must be flexible. Some of the things we think we can do and do well enough on the Moon may not work out or present engineering and prerequisite difficulties that mandate putting them off until later. Other unsuspected opportunities for useful and profitable activity that can be supported early on will emerge. The exact sequence of diversification into iron and steel, glass and glass composites, ceramics and cast basalt, and lunar concrete, should be kept provisional and open to unfolding realities of need and ability. Expansion must then be both flexibly preplanned and opportunistic. This is in fact how things unfold on Earth. It will be no different on the Moon.

Addition of “Out-Facilities”

Initially, the outpost will be quite compact and integral with the only peripheral installations being solar arrays and radiators, antennae, tank storage farms, the space pad, power generation and storage etc. But the time will soon come when we will want to move industrial operations that have passed their field trials out of the ‘incubator’ space within the original outpost complex into new, more spacious, and more rationally designed industrial quarters more or less nearby. Such industrial space may be connected to the outpost by a pressurized corridor tube or “cunicula” of some sort, or it may be accessed, also in shirt sleeves, by a docking personnel transport coach. However, if the facility uses a lot of raw materials “mined” at some distance, the whole industrial operation might better be placed at a suitable site handier to the source.

Another unconnected complex likely to arise early on is a “Port Operations” facility at the Moon base spacepad site, as the pace of expansion increases and with it the amount and frequency of traffic between base and Earth and/or Earth orbit. Additional “exclaves” may be at an astronomical observatory installation within logistical support range of the outpost, and even a sort of getaway recreational retreat, say on the scenic rim of a large not-to-hard-to-reach crater or rille. ‘Androgynous’ dock-locks will make such actually separate installations functionally contiguous allowing easy, safe, and comfortable passage from one to the other. Keeping pace with all this will be an expanding road network, reworked as need be to handle more frequent and heavier traffic loads.

Room for Visitors

At first, there will be no room or provision for “non-working” visitors. As the outpost expands, spare quarters for guests may be set aside (possibly the original, now outmoded crew quarters). Only as the outpost expands to the point where potential income from visitors outweighs the “bother” that looking out for them will cause, will a real ticket-purchasing visitor influx begin. The outpost will then have a dedicated hotel, a tourist excursion coach, and an itinerary of visitable sites. And outpost population will have grown quite a bit. ☺

opportunity to “get out of here” is some time off, one grins and bears the restrictions, the confinement, and the sacrifices with or without a smile. But if ships are returning to Earth on a regular basis and one’s “moon duty” has already “worn thin”, then the desire to be aboard the next ship home will begin to interfere with one’s effectiveness. Perks, extra amenities, and other incentives to make continued surface duty more bearable will be absolutely necessary.

Pay: we start with the obvious: money, the worth-while-maker. As duty extensions are cheaper than crew replacement, some of the “savings” realized are properly shared with those agreeing to stay on, in terms of higher wage rates. Wages can be sent to one’s Earthside family, or accumulate in a terrestrial bank account. But there are other forms of compensation.

The “re-upper” can be rewarded with “import credits” e.g. the right to request added momentos, pastime materials, or favorite food delicacies to be on the next ship up. One can acquire seniority for bidding on desirable assignments. One can be admitted to the decision making councils. One can be granted more “flextime”, leeway in personally scheduling work time and free time.

Time off: sabbatical week “vacations” would be a very special perk, one that the “reupper” can use to explore in greater depth any hobbies or interests — experimenting with lunar art/craft materials, dance forms that go with the grain of sixthweight, exploring and developing confined space sixth-weight sports ideas; music, poetry, literature, and writing articles for hire reporting on life on the Moon. It is important to realize that all such activity can be indirectly productive for the basehold as a whole if and in so far as it opens up more possibilities for other personnel to enjoy their stays.

Attention to ambiance. Not all the perks should be reserved for those who agree to duty extensions. By then the psychological damage from unnecessarily spartan conditions may be irreversible. The outpost can be made both ergonomic and functionally pleasant at little or no extra weight penalty or cost simply by thoughtful design. Crew quarters can be individually decorated, and easily redecorable to suit the tastes of new occupants. There should be varied and redoable decor in the common areas. There should be cubbyholes other than one’s own cramped berthspace in which to retreat. Attention should be paid to acoustics so that one has the choice of background music or silence or his/her own favorite blends.

Rotation of assignments: no matter what one’s specialty, there should be the opportunity for shot-in-the-arm routine-busting assignments. Those regularly in the field can be given inside duty for relief. Vice versa, those stuck in labs and workstations can be given periodic field duty.

Leisure time opportunities: the outpost should have a good audiovisual and literature library, in the lightest weight storage form, of course. There should also be some traditional art and craft media and the opportunity to explore working with on site materials. Requests should be honored when feasible for “time off together” for those wanting to explore dance or sport or other “exercise” options. There should be “real” opportunities as well for continuing self-education, personal or occupational, for credit when desirable.

A bit of Earth: relief duty in the outpost farm, even if nothing but a compact hydroponics closet operation, will be welcome to most. In addition, an abundance of well-chosen “house plants” will not only help keep the air “fresh and sweet”, but provide a psychological filter against the barren and sterile surroundings outvac - especially if arranged in the foreground of any window or viewing port. Available nooks and crannies can be the opportunity for “pocket parks”, even “forests” of bonsai evergreens.

Water reserves can be put to work as well. Fountains and wallside waterfalls add both soothing white noise to help drown out the non-symphonic hums of assorted equipment, and to keep the air comfortable and rain-fresh. Aquaria can add the further comfort of “wildlife”, color, and visual relief. Another opportunity for “wildlife” will arise once the outpost “farm” reaches the stage where natural pollination would be helpful. Bees, butterflies, and hummingbirds are candidates.

Scarcely anything, however, is more important for morale, day in and day out, than menu diversity and good tasting food. Bland nutritional balance is hardly enough - not out of the ivory tower. The outpost pantry should be kept well-stocked with herbs, spices, and peppers.

Toward “Social Normalcy”: the desire of outpost mission planners to control and otherwise restrict the range of “permissible” social activities will be strong. On the one hand there is the legitimate desire to have things run smoothly and discourage behavior that can be disruptive. On the other hand there is the illegitimate pressure that comes from having the rest of the world looking over your shoulder with their assorted hangups. The solution to both has to be a very real degree of privacy with limited and scheduled public “telepresence” along with a degree of discretion given to on site authority.

While the variety of social interactions will become measurably more satisfying as basehold population increases from shy of a dozen towards a hundredfold or more, nothing should be done to control or restrict spontaneous sexual liaisons, romances, and relationships so long as they do not begin to interfere with work or with the morale of the rest of the personnel. That said, it remains a pretty good truism that fraternization “at work” is a bad game plan, full of pitfalls and well documented by horror stories. Nevertheless it happens.

Pregnancies will be strongly discouraged at first (cf. the ABC movie “Plymouth”), and perhaps be reason for early termination of tour. Yet sooner or later this is a plunge that must be taken. We cannot know for sure that the Moon is a potential long term new home for man until the second generation of native born turns out healthy and fertile.

A more serious potential problem is the development of a medical condition that would make survival of a trip back to Earth problematic. It may never happen.

What to do with someone who has done something unforgivably antisocial or outright criminal is an eventuality more likely to occur. “Out the airlock without a spacesuit” is not an option. Confinement to quarters (makeshift brig) means a loss of productivity. The alternative may be to assign the person to undesirable but necessary duties, inside or outvac. Menu and free time restrictions might be effective penalties. No amount of prior screening can prevent trouble altogether.

Sooner or later someone will die on the Moon either by accident, by sudden illness, or by foul play. Shipment of the remains to Earth should not be automatic. The person in question will have signed a living will which states his or her preferences. Internment on the Moon should be an option. Nor need this mean "burial". If the outpost has a furnace that can serve as a crematorium, one can specify his/her ashes to spread inside in the outpost "flower garden" or "pocket park" or outvac in some chosen or favorite spot. If not, another option is simple surface internment, under UV-proof glass, otherwise exposed to the vacuum, and the stars. More than any flag, a burial site makes a place, however desolate, forever human.

Longer term. So much for beginnings. Our humble lunar outpost will have to number more than a hundred before there is enough diversity of talent, occupation, opportunity, and social interaction to make indefinite stays tolerable even for the hearty few.

The mini offspring biosphere with which the frontier community reencradles itself will have had to become much more massive, self-regulating, and forgiving before all but the most determined will be willing to give up ever returning to the lush green hills of Earth. We will have had to have progressed from outpost-with-houseplants to biosphere-with-farm-and-farm-village, and a tad of compatible or insulated industry on the side.

Economically, we will have to be manufacturing on location a visibly large portion of our needs, particularly expansion shelter and furnishings. Thriving indigenous arts and crafts will begin to endear pioneers to their new world be home and start to add to the list of things they would have to "give up" were they to return to Earth. When this list becomes personally more cogent than the list of still missed things they gave up to come to the Moon, the balance will be tipped.

We will have had to make the commitment to the less direct productivity of child rearing and retirement. And perhaps these two needs can take care of each other. Parents can work while retiree "grandparent" volunteers (with enough energy) can teach and raise the young. In general, there must be programs to keep all citizens as productive as possible. In this light, retirement becomes more of a shifting of gears, of switching to less stressful, more relaxed, less demanding "half-time" assignments. Besides teaching, administrative paper-pushing duties come to mind. There will be other things. Everyone must, and must be given a full range of opportunities to, pull his or her weight in the forever upward struggling pioneer frontier community.

Population will have to grow too before their will be enough of a gene pool upon which to base a stable permanent population, if, for some reason, the traffic from Earth should be cut off, forcing the infant community to go it alone, hopefully in economic interdependence with other similarly stranded off-Earth pockets of humanity. While this seems far off, it is a scenario which has long motivated space supporters.

The journey of a thousand miles begins with the first step. We've tried here to outline some of these first steps, as well as some other forks in the road a bit further along. If it is going to all happen, we will have to consciously take these steps in a timely fashion.

MEMO

Rethinking the **MOON BUGGY**

Reflections from Dale Amon

[amon@vnl.com - Dale, chair of the '87 "Merger" ISDC in Pittsburgh, now lives in Belfast, Northern Ireland.]

Who would *want* to [build new lunar rovers from the old Apollo era plans]??? By today's standards the electronics on that thing are a science fair project...

Replace the frame with composites from Scaled Composites. The electric motors will be a fraction of the size and weight because magnet materials have improved *vastly* since then. Storage technology has not improved by as great a degree but still, it *has* advanced. We'll have commercial micro-machine accelerometers on the market soon, so the navigation hardware will be built right onto the chip with the electronic interface. The comm gear has shrunk to nearly nothing. Compare a walkie talkie in a 60's era Edmund Scientific catalog with what you can pick up down at your local Tandy Radio Shack. R/C toys have better radio equipment than some of those 60's comm units...

And then, most importantly of all - we *know* the environment it is to work in and have those old rovers, their problems and performance as an initial data point. And that data point is basically that it is no big deal building one. They *are* a piece of kit that a hobbyist could successfully build. It doesn't take an aerospace company to build an electric dune buggy.

Just a bit of caution on vacuum, a bit of thought on rad hardening, a bit of care on temperature range... And you needn't bother about outgassing of your materials. They'll never be inside your breathing space so who cares? That makes it a lot easier.

Oh, and some care in packaging may be required to insure it isn't damaged by the vibration. I remember ruining a tire on my DT400 by not tying the tire down when hauling it in a trailer behind my car. Tire spun from the vibration and wore the nobbies bald...

From Rovers to Cycles — Human Power

While walking home recently one night I remembered some thoughts I had on lunar rovers a number of years back. There will be a need for different sorts of vehicles, and undoubtedly large hauling vehicles, whenever they are required, will need a good power source. Whether that be fuel cell, battery, solar power, beamed power or some mix I won't go into here. But the type of vehicle needed for a small relatively self sufficient group should have a number of characteristics that few of the designs in the literature ever consider.

- ⇒ The motive source should be 100% field repairable preferably with only a few tools and simple spare parts.
- ⇒ Spare parts should be such that they can be manufactured locally from small amounts of raw materials.
- ⇒ The vehicle should have a fail safe criteria that it can bring the driver home under almost any circumstances in which the driver is still capable of driving.
- ⇒ It must use indigenous energy supplies.

Now if you look at these requirements through the old

fashioned NASA eyes, you will come up with a billion dollar project. If you look at it with the eyes of an engineer, you immediately come to the conclusion that a human powered vehicle is just the ticket.

Research backs this up. In a *Scientific American* issue on Human Powered Vehicles a number of years ago, an article on bicycles had an extra data point for the performance of a vehicle on the Moon. A racing biker, with no air resistance and 1/6 g could break 1000 km/h in sprints. A normal, healthy person could cruise at over 100 km/h all day, and could *easily* pull a trailer load at the equivalent of typical Earth-bound auto driving speeds.

The form of the vehicle is the recumbent bicycle like that used by Stephen K Roberts (Computing Across America). And in fact, he would probably be the best person to speak to on the design of a lunar rover. He crossed the USA from end to end several times on his recumbent, traveling up and down through the Rockies, keeping up reasonable highway speeds - and all the while with a trailer that included solar power gathering and a satellite uplink so he could type on the keyboard in front of him (while peddling) and submit articles to magazines that funded his journeys. He also had navigation and maps built into his console processor. I don't think there is anything that a lunar rover built for days of unsupported prospecting would need that he didn't do 5-6 years ago.

Now, that is not to say there aren't issues unique to the Moon. There is the issue of traction and off road travel which will drive the gearing ratios, axle loading, weight and balance, and wheel design.

Braking will have to be dynamic, feeding the energy back into a dynamo. Normal friction brakes are a bad idea for two reasons - 1) The abrasiveness of the regolith. 2) Brake cooling is purely by radiation to the background and conduction through the frame. Radiators are a problem as has been suggested before; and since I expect the frame to be composites, conduction is not very good either.

Gears and chains and derailers will have to be *very* robust and spares will be required. A design that can be field welded would be a good idea. Better to trade off a bit of elegance and performance for field maintainability. These parts can be built very ruggedly (I'm not talking about racing bikes here!!) and would need to be able to withstand the rigors of large temperature swings and abrasive particles. One could seal them, but then it is more difficult to field strip. And not to mention which, without herculean efforts the lunar grit will get in anyway. If anyone out there was in *Desert Storm*...

Another area of concern is space suit cooling. The loads will not be excessive under normal cruising since the peddling is only enough to replace frictional losses.

Use of a small motor like that in a mini bike could solve a number of problems (if they don't add too much complexity on their own). The motor could be the means by which braking returns energy to storage. Energy can be recovered on downhill stretches and used to ease uphill travel. It also can reduce the heat loading on the space suit during acceleration from a standing start, or indeed any acceleration under load. The motor would, of course, need to be built such that it can be disconnected from the system entirely if it fails.

The over all system would have to be able to get the lunan back home regardless. So think of it only as a luxury item on the bike.

The suit would be a live-in suit, so that puts some extra design load on it. You might have to do better than a diaper if you're going to be out for a week... But this is a problem that needs to be solved anyway. The Stars Wars rovers that some NASA scenarios show us are not going to be feasible on any realistic budget, and in any case you'd only be able to afford one of them for the same price as giving every lunan their own personal lunabike.

It seems wholly superior to any rover concept I've yet to see. Just about anyone out there could have run circles around the Lunar Rover and been out 20 km and back before it was barely out of sight of the LEM...

Ah, you say, bikes are good on highways, but off-road you're going to want a trike! The lunar surface has huge areas that are much like beaches and dunes. Covered with hardpacked fine regolith that follows the contours of the land in a very smooth and gently rolling fashion. This is not to say that crater rims and such are quite the same - but large tracts of the Moon should be easily negotiable.

As to bike vs. trike, there is no inference above, of a two wheel design - in fact I believe the recumbents are usually trikes. At least the Robertson one that I saw in 1989 was... **DA**

Out-vac trike-uits are a challenge

by Peter Kokh

Sounds delightfully low-tech, doesn't it? Tired and stressed out after a long day's work in your lunar office, mine, or factory? Just don your out-vac trike suit and head for the airlock and get some heal-all unwinding exercise! Reminds me of an Arthur C. Clarke's story where the hero does a kangaroo-lope to safety 600 km across Mare Imbrium in just a spacesuit.

The question arises: without an open air heat sink, where does all the body heat generated by such exertion go? An out-vac triking suit needs not only to be self-contained (in RV-camper-trailer talk that means "with toilet"), but able to handle/ shed internally-generated heat and perspiration as well. That also means being able to keep the wearer from getting a chill soaked in his/her own sweat once the exertion is over. Perhaps the suit's insulation material could be an *eutectic salt* in a quilt of pocket cells, melting to absorb internally-generated heat, solidifying to release it - automatically, on demand. **PK**

Or Perhaps a "Buppet" Bike

by Phil Chapman <pchapman@BIX.com>

with permission, from a post on Artemis-list

[* **Buppet**: *etym.* from Body Puppet]

(on the analogy of Muppet from Mitten Puppet)

Note: "buppet" is the editor's word, not the writers

See MMM # 89 OCT '95: "Dust Control" pp. 6-7 -
Republished in MMM Classics #9]

Having tried both [an EVA suit and a diver's dry suit], let me tell you that a pressurized conventional spacesuit is *much* more restricting than a drysuit.

Spacesuit design has been hampered by thinking of it only as a *garment*. It is also a small space vehicle. A conventional suit is no place to be for more than a few hours. For longer durations, you need to be able to pull your arms in so that you can scratch, or eat, or sleep, or void. This suggests that the lunabike should be integrated with the suit -- in other words, the suit would be a lightweight pressurized canister with wheels (4, for stability), with a shirtsleeve internal environment for pedaling and living. The canister would be equipped with pressurized gloves, waldoes or other attached tools for manipulating the external environment.

It might be necessary to carry a conventional suit, donnable inside the canister, so that you could get out and get under if something broke, or go climb that cliff over there (where, as Arthur Clarke has told us, The Sentinel is waiting), or, in extremis, walk home. For routine use, (such as getting from one pressurized dome to another) the mobile canister alone might be sufficient. The real safety reason for carrying a conventional suit is to avoid potentially fatal single-point failure modes, an objective that might be met by careful design of the canister/bike alone.

PC

No, what we need is a Volkscycle!

Response from Dale Amon to Chapman's suggestion

[What I have in mind is an outvac cycle that fit's every lunan's budget. So] the bike must be mostly buildable from local materials with simple tools and basic stock materials; all systems required for it to function as transport must be field repairable. Simplicity. Something a back yard mechanic can build and repair - exclusive of the electronics, of course - but there should be no electronics that are absolutely required for the bike to operate. Electronics must be something that is bolted on and if necessary unbolted and tossed into a crater to lighten the load...

The minute part of the design requires a special tool or material, my design criteria demands that that element be discarded from consideration. Simple. Indigenous. Independent.

Ad Astra! - Dale

Human-Powered Moon Trike

Call for a Technology Demo for ISDC '98 - Milwaukee

One of the more ambitious goals outlined in the plan for ISDC '98 - Milwaukee is to present a number of low budget (\$100-\$5,000) technology demonstrations of tidbits of technology that will be needed, *or useful* on the space frontier, and which should not take that much money to demonstrate.

A human-powered Moon Trike is such a possibility. Because gravity is only 1/6th Earth-normal, but momentum remains *full* Earth-normal, to prevent tipping, the vehicle should have a very wide track, wheels that lean into turns, and a low center of gravity (hence a recumbent rider position seems ideal). Any interested group should attempt to find its own industrial and corporate sponsors, advisors, project managers etc. and register their effort with ISDC '98 - Milwaukee, P.O. Box 2102, Milwaukee WI 53201 which will attempt to provide advice and assistance.

MMMM

[Pioneering a Moon-appropriate art medium]

Waterglassing

R&D Report: #4 — 11/05/'95

by Peter Kokh, amateur artist

RECAP: This is a "Lunar Arts/Craft" R&D Project aimed at determining if "paints" suitable for use by artists in a pioneer settlement can be made entirely from elements recoverable from lunar regolith soil. The idea is based on the fact that sodium silicate, commonly known as "waterglass" and a liquid at room temperatures, is the only known inorganic adhesive. It can be produced from lunar soil, and the basic experiment is to see if adhesive-based (rather than solvent-based) "paints" can be made by mixing in colored metal oxide pigments.

The first painting, Moon Garden #1, was produced 9/29/'94 using sodium silicate, titanium dioxide (white), manganese dioxide (black), ferric iron oxide (rust), chromium oxide (green) and sulfur (yellow) and combinations of these to produce gray, orange, and pink. The "canvas", again picked because it could be produced locally in a lunar settlement, was glass, painting, foreground first, on the backside.

An article about the project appeared in the Jan/Feb '95 issue of *Ad Astra*, pp. 46-7. Since then other pigments have been tried, not all successfully. The most notable (and costly) addition to the palette being cobalt aluminate blue.

The Aging Problem - Worst fears allayed

In a few months, the first two paintings had begun to show patchy delamination from the back surface of the glass. The prime suspected culprits were low winter indoor humidity, a film of windex on the glass, or, worse, a temporary aspect to the adhesive quality of the medium. The third painting, done in mid May addressed both the first two concerns. The pane was baked after cleaning to remove residual windex film. And the air was now more humid. Six months later, this painting looks much as it did the day it was produced.

While this allays the worst fears, that waterglass painting may turn out to be suitable only for "temporary art", we are not ready to claim that the problem is solved. This is an experiment, and it is the nature of experiments that sometimes the desired result is not, even cannot be, produced. Time alone will tell whether or not this "aging" will continue, whether or not it can only be postponed, etc. We will not resort to organic additive "fixatives" as this would invalidate the experiment.

New Pigments, methods tried

In the past several months, some new pigments have been purchased. Iron Sulfide, FeS₂ (fool's gold), yielded disappointing results. Vanadium Pentoxide, which promised a bright golden orange joined the ranks of three previous "failing" pigments in immediately reacting with the waterglass and gumming up. Chemicals that had not worked now represented an investment of well over \$200. However, a somewhat crude "work around" application method promises to recoup some of this investment and expand the palette. We have succeeded in "flocking" one of these four powders on glass wet with plain waterglass. Potassium chromate gives us a brighter, more vivid yellow than the pastel sulfur we've been using so far.

New paintings, sales, gifts, donations

This fall saw three more paintings. "Out the Window" depicted an oval window in a lunar habitat, looking out on the Moonscape (painted on the reverse side of an 8x10" pane) with the peripheral foreground inside the habitat painted on the front side of the glass. It was donated to Greg Bennett, CEO of the Lunar Resources Company and chief architect of the Artemis Project™ - after hanging "NFS" [not for sale] in the First Contact II art show. Also in the show, up for bid, was "Earth in Space" painted on the reverse side of the 8x10" glass, with however, the clouds on the front side of the glass to create depth and show that they were not Earth surface features. This went for \$60. A small 5x7" demonstration piece, "Moonscape" was donated to the charity auction and went for \$12. The following week, the second painting produced (mid-October '94) called "Greening the Gray" was donated to the MSDC seed money raffle. Meanwhile, membership in L.A.A.M.P./subscriptions to semiannual **Moonbow** [no longer available], crept up to just ten.

Waterglass-aided Stained Glass Experiment

We hope to soon begin diversifying work with waterglass. Stained glass (art glass) is certainly a viable lunar art-form, materials wise, with one exception: the "leading" that separates/joins the individual colored glass cartoon pieces. What we want to try is cementing these colored glass pieces, using waterglass as an adhesive, to a host transparent pane, filling the gaps with a thick paste made of waterglass and common regolith simulant. The look should be similar enough, and the heavier pieces will be lighter in lunar gravity. **PK**

Commercial Moonbase Brainstorming Workshop

Report by Peter Kokh, First Contact II Co-chair

On October 7th, 1995, at a Science/Science Fiction Convention in Milwaukee called **First Contact II**, LRS hosted a 3 hour brainstorming workshop on the "Design Requirements for a Commercial Moon Base". The Lunar Reclamation Society (NSS-Milwaukee) and Milwaukee Science Fiction Services are joint partners in this new hybrid convention. Leading the workshop was the special LRS "Doer" Guest of Honor, **Greg Bennett**, CEO of The Lunar Resources Company in Houston, and chief architect of "The Artemis Project"™. Co directing the session were Mark Kaehny and Peter Kokh of LRS. David Burkhead of *Spacecub* fame also participated. There were eleven of us altogether.

After a few general remarks about what we were going to attempt to do, **identify things a first lunar outpost could do to make money**, we broke up into two brainstorming groups (larger groups are unwieldy).



Group A: Greg Bennett, Mark Kaehny (group secretary), David Burkhead, Edwin Reck, and Mark Roth/Whitworth — came up with the suggestions below.

⇒ The numbering reflects only the order in which the suggestion was made - given the limited time, there was no attempt to put these ideas in a logical order, much less to come up with them in a logical order - brain-storming, by its very nature, has to be free-ranging and unfettered. The inevitable chaff can be separated out from the wheat later. The dynamics of group brainstorming is such that an idea presented "half-baked" by one person, can then be "fully baked" by others in the group. It is an exciting process.

⇒ The contents in square brackets, [], are added by the MMM editor, a non-participant in Group A, and *may or may not* accurately qualify or reflect the intent of the suggestor.

1. (a) CD-ROM "Artemis Story", (b) full video interactive 3-D animation videotape with celebrity speakers. - [from Ed Reck]
2. Sell rides on training equipment similar to Rand Simberg's Space Lines. Actual training.
3. Photo CD-ROMs pictures. Documented Travelogs, National Geographic style.
4. An online WWW pay-for-data site.
5. Animé - Japanese Animation - CD-ROM, magazine story.
6. Licensing the Setting i.e. of "the Artemis Universe"
- (6a) Creating "Artemis" Product Lines - Children's toys.
7. Scientific sponsorship - rack space and crew time, paid for by corporations as good will advertising
8. Hardware junkie big name contacts" - Bill Gates?
9. Flight Models - Estes type static models and mockups [for sale to theme parks, air and space museums etc.]
10. Babylon 5 newsgroups - meet people - Staszynski etc.
11. Sell Lunar Samples, Made on Moon scientific novelties
12. Sell [lunar regolith] simulants and scientific novelties
13. Television Story - Shows on all possible variations on "nationality of the Moon"
14. Solar Power Demonstration - small power satellite
15. "Save the Earth" - sell concern for Earth's future
16. Sponsoring Conferences - make money off of fame, leverage off fame (credibility problems?)
17. Sponsorship of Companies - "Proud Sponsor of ..."
18. Sell bricks made from lunar regolith simulant
19. (a) Selling place names on the Moon [of small features to be named after donor etc.] (b) Selling burial plots on Moon [for lightweight cremation ashes.]
20. Long term storage in cold rad-sheltered vacuum: sperm and egg bank; biological and pathogen samples; archival space for data and knowledge stored on magnetic media; etc.
21. (a) Robotic Probe - B/W 10 frames/sec. [illustration below]

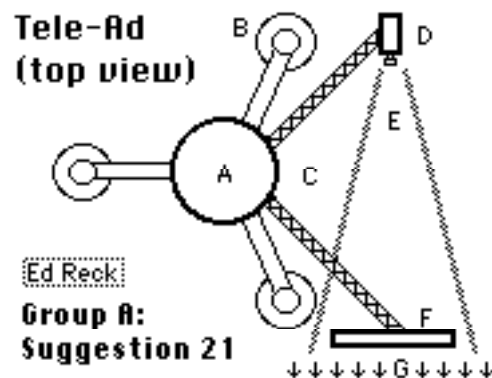

KEY: A. Lander core with power and communications package; B. One of three landing pads; C. retractable booms; D. videocam; E. Videocam's field of view; F. Electronic message board telechanged from Earth; G. Background scenery.

Another idea was to draw messages on sand with a stick, and photograph these. [anything from ads to expensive but cherished Valentine Day "I love you" cards - authenticated.]

(b) Signs on the Moon whose message can be telechanged from Earth, with image of sign in lunar setting transmitted to Earth - i.e. real time unobtrusive advertising on the Moon.

22. High Definition digital video [the Artemis Story, etc.]
23. TV produced on Moon. Aerobics, Kick Boxing and Karate, [and the obvious bootleg videos which must remain *rumored*.]
24. Selling 1/6th g rides on counterweighted gym sets [such as the Mars-grav weight compensating gym set made by Ann Arbor Space Society]
25. Sports Programs [uniquely lunar sports that do not need a lot of pressurized volume - with fast, neat action and high spectator value - direct pay-for-view broadcasting to Earth]
26. Maps of Moonbase area [wall murals, placemats, anyone?]
27. [Static] Models and working models
28. [Merchandising mail order] Catalog of cool space stuff
29. Pay to work schemes [like architectural and paleontological "digs"] Hands on patronage. Field Trips. Sponsored trips [can be to terrestrial sites where neat preparation and simulation things are happening]
30. A newsletter "Holidays on the Moon" published when morning comes to the proposed settlement site [i.e. *moon*thly]
31. Medallions - [individualized] matching set - one sent to the Moon. You keep the other one.
32. Mission Control Center for the Artemis landing missions to be located in a Theme Park [pay-to-observe]
33. Coin-operated games; your face in a cool Moonbase setting
34. Limited Edition Prints, signed by artists, countersigned by the first return crew - e.g. famed artists like Kim Poor
35. Mural Pictures [Murals are scenic wall papers 4 large pieces across the top and 4 across the bottom, not pre-pasted. Environmental Graphics of the Twin Cities is top manufacturer of nearly 2 dozen scenes which sell for \$40-50 and include Earth over Apollo 17 landing site, Columbia in orbit over cloud-studded Earth, and Saturn and its moons]
36. Space-wear and Moon-wear clothing for Ken, Barbie dolls.



Group B: Peter Kokh (group secretary), Fred Oesau, David Crawford, Doug Seitz, Jim Plaxco, and Kevin Crowley.

⇒ Whereas Group A concentrated (not exclusively) on money generating ideas to get the Artemis Project "on the way", Group B chose to concentrate (again not exclusively) on money generating ideas that would apply "once a permanent occupiable outpost was set up".

1. **Testing/tending** of prototype feasibility demonstration **equipment** for mining operations, beneficiation processes, other processing: e.g. lunar oxygen production, silane [silicon-based analog of methane] fuel production; iron fine extraction and sintered iron product manufacturing; i.e. Artemis crewmembers serve as time-share mission specialists for companies hoping to do industrial business on the Moon.

Money would be earned not only from providing time-share trained labor. Income would also be generated by carrying along equipment to the Moon, shipping back various processed and manufactured samples, etc. i.e. renting payload space and mass aboard the Lunar Transfer Vehicle, and descent/ ascent vehicles.

2. **On site Advertising.** More elaborate possibilities than in # 21 above because of the availability of crew for non-electronic changeouts, as well as part time models, actors, etc. The availability of crew also permits greater latitude in changing the all-important background setting, i.e. in total picture composition. It allows moving "commercials" as well.

3. **Setting up and Tending Telescopes** and other astronomical installations (changeout of instrumentation) for university-consortia etc. This would involve trained time share crew as mission specialists, and fees for payload bay space and weight as in # 1, above.

4. **Teleoperated "Working" Robot-Rovers** - Artemis sells **minutes/hours** for the right to teleoperate mobile equipment that (a) emplaces regolith shielding over the habitat complex; (b) grades approaches and aprons, improved landing pad, etc.; (c) collects dust and rocket samples.

Time could be purchased directly, or, seeing that it would be expensive and eliminate all but the best-heeled of individuals, corporate sponsors (or Artemis itself) could raffle off the right to teleoperate such equipment, after a minimum number of hours of simulation training, of course, this included in the package, so that the actual time would be well spent, both to reward the lucky individual teleoperator, and to maximize for Artemis the efficiency and safety with which the needed work gets done.

This concept would not be unlike going on a paid "teleoperated" archeological or paleontological "dig".

5. We **noted** that many income opportunities will presuppose that Artemis planners had picked a **visually exciting site** with its surroundings, not just a scientifically exciting one.

6. **Photograph panoramas** deserving of being rendered as **wall murals** (wallpaper, see #, Group A, above). This will include one of the Artemis Moonbase itself, either/both as under construction or/and as completed (phase 1), as well as various untransformed scenic vistas in the area.

Some of these murals could be available for open reproduction, others sold in limited sets of 100 to generate high individual auction/bid prices.

7. **Telerobotic lessons** sold separately to qualify winners of teleoperation time. See # 4, above.

8. **\$100 million lottery** - winner to be trained as time-share mission specialist along on the first, or second mission.

9. **Teleoperable manufacturing equipment** to be engineered by rival competing engineering teams *pro bono* - the carrot reward being the right to get a percentage return or royalty on income generated by the teleoperated device for the its operational lifetime.

10. **Entertainment pay-per-view TV produced on site**, capitalizing on eerie effects of 1/6th gravity: one or two person ballet performances (doable on a small set); midget sumo wrestling (our apologies to the Little People or those of Japanese descent to whom our fun suggestion is offensive);

once a bigger "gym" is available, Lunar Jai Alai.

11. **Made, or hand-selected on Moon artifacts**, coins, jewelry. Cut and polished breccia broaches or ring stones. Sintered iron coins to be polymer coated against rust on arrival on Earth. Items made of glass spherules. Necklace glass capsules half-filled with common regolith Moon dust.

Weightier and thus *much more expensive*: sinter-cast block which bears your own footprints, made on the Moon with a casting or your very own foot/feet or shoe(s)/boot(s). Sinter-cast blocks with custom valentine-type message.

12. **Selling Names**: of modules and parts of modules of the outpost and lunar descent vehicle. e.g. the John Doe porthole, the Jane Doe Hall (meetings, TV studio, dance hall, gym, Jai Alai court, etc. etc. multi-use larger volume hard hull module or inflatable.

Also getting corporations to pay for additional mods or upgraded interiors of planned modules - all for the ad value = e.g. "furnished by Apollo interiors, of city, state."

13. **Repository for cremation ashes**. This can be under the open star-spangled sky, UV-protected by a quartz pane.

14. **Biological Quarantine Facility** for sample all-but-extinct pathogens and toxins too dangerous to be kept indefinitely at the Contagious Disease Control Center in Atlanta. An associated lab could be a follow-on.

15. **3D computer-controlled variable mold stamping** device which will render your footprints/handprints and a photo of same on the Moon, in an area to be set aside not ever to be re-disturbed. Different from # 11 (second paragraph) above.

16. **Lunar Spaceport Beacon** which can flash messages (commercial ad or personal [monitored] for a high fee) in Morse code when visible from Earth during local Moonbase nightspan. [see MMM # 89, OCT '95, page 1 bottom]

17. Along the same line, experiments in local nightspan **fireworks and light shows** to be paid for by sponsors on Earth for very large terrestrial audiences on special occasions.

18. Afterthought on # 11 **jewelry** ideas above. For necklaces, glass spheres with actual lunar vacuum (glass is stronger under compression)

19. **Actual Signatures on the Moon**: Artemis would sell the right (and small space) to write/engrave your signature on various pieces of structural or operating hardware(a) to land temporarily on the Moon = cheaper, or (b) be part of the permanent outpost installation. This idea is attractive because it does not add to the weight or cost of the hardware to be landed on the Moon. A much less expensive option (c) would be to take along your signature in microfiche or electronic form.

Reflections on the Workshop

As I had guaranteed Greg Bennett as we were about to start, this process was sure to come up with many ideas that have already been thought of in previous Artemis Project brainstorming sessions, but also certain to come up with some new ideas previous groups had not thought of, or at least new variations. Afterwards, Greg assured me that the Workshop had delivered as promised. All participants found the exercise very stimulating and the high point of their convention.

In Houston and in Huntsville, the ideas outlined above will be merged with the results of previous marketing and income generating brainstorm sessions. ###

Mail Box



Space Oases, in MMM # 87, July '95

8/24/'95 - I was glad to read your article in the July MMM about Space Oases and see your emphasis on modularity. This is a concept I've long advocated for both space development and the development of a powerful space advocate community. I think the space enthusiast community is going to come around on the issue of modular space infrastructure development, to some degree and eventually. But I wonder how much good it will do most people without a similar approach toward building a politico-economic power base.

Anyway, with regard to modular oases --whether in space or on a planetary surface:

1) It is feasible to build a large sphere modularly.

One must merely divide the sphere into appropriately sized and shaped sector volumes. There are a number of ways to do that. Latitudinal slicing and geodesic segmenting are the easiest two for me to think of off the top of my head. Regard-less of the particular geometry used one must merely begin with a balanced rotational system (since we are talking artificial *G* systems). In the design cycle the "sectors" (habitable volumes) would be sized as dictated by economics, required crew size, and various other factors. The two initial masses (whether both were living spaces or one were merely a counter weight) would be either hard or soft tethered with further tethers added (if necessary) as more modules are added. As an example, for the longitudinal slicing method, the first modules would be equatorial, as would all further modules until a torus was completed. Then additional modules could be added at "higher" latitudes (requiring careful balancing) or nearer the center of rotation (only requiring equal masses on evenly spaced sides).

2) As regards workers shifts: I would propose (if three shifts is the case) that the factories be located in modules between the living modules (one to three modules in addition to the living modules). My thoughts are that factories tend to be noisy, they would pose an unnecessary risk of pollution to the general population's environment, they pose an unnecessary risk of catastrophic damage to the living area's life support functions, and they could be in a constant state of "day time" without affecting any living volumes schedule.

I agree with you regarding modern America's risk aversion and the nonsensicalness of 1 *G* bias. But where it is inexpensive enough economically and logistically I wouldn't rule out lowering risk or raising gravity levels.

The Torus [Helix?] is an elegant solution. I like it! The most exciting future would see many different options developed and used.

Modularity both in architecture and in develop-

ment/construction schedule would be useful on planetary surfaces as well. For instance, if a small robotic/remote control digger/hauler were at work now, how ready could it have an area on the Moon for an oasis in ten or fifteen years? And if every year or two another robot some with similar some with other capabilities were also sent then how far along could an oasis be when it finally became feasible to send humans? And as construction progressed there would be greater and greater incentive to send humans and less and less of an infrastructure hurdle to overcome.

Richard Richardson

< Rrrspace@aol.com >

Doering, Alaska

EDITOR'S REPLY: While a sphere can be imagined as a combination of radial segments, and perhaps, on Earth where there is no differential between inside and outside pressure, such segments could be built one at a time. But not in space, at least not if you are going to pressurize them. Pressure wants to make everything round! **PK.**



Triple Helix Space Colony seems ungainly
[MMM # 87 JUL '95 "Space Oases, Part IV", p. 8]

Nature doesn't use the triple helix very much.

Myoglobin molecules, which somewhat resemble triple helices are crosss-braced. Even Watson and Crick's abortive initial attempt at modeling DNA as a triple helix had an internal backbone holding everything together. It's a rather ungainly structure.

Jeff Sanburg,

Skokie, Illinois

EDITOR'S REPLY: Just as the torus space colony has a hub, the helix, double or single has a hub-shaft. And just as the torus has supporting spokes connecting it concentrically to the hub, so will the helix, double or triple, have rhythmically spaced spokes to the central shaft. I was incapable of illustrating this structural feature in my crude MacPaint graphics program and hoped that the reader would assume it.

Whether nature uses the triple helix or not is immaterial. The design is structurally stable from an engineering point of view, and if growth from all three end points is kept apace, dynamic equilibrium will be maintained. Nature *does* use the radial plan (starfish, octopus, flowers, etc.) and the triple helix can be seen as a radial derivative. — **PK**



Dust Control, Space Suits, Terrestrial Uses

11/02/95. "Dust Control" [MMM #89, pp. 5-7] was an excellent article. There is a way that we could get some of this hardware developed prior to returning to the Moon. The universal door-lock and the turtle-back suit would appear to have real application in the area of radioactive waste management and other hazardous environments. The concepts of keeping the nasties out, shielding, and working at a positive pressure with respect to your environment are common to both the radioactive waste problem and the

Moon.

It is becoming increasingly clear that there is an enormous clean up effort that must be done in the wake of weapons production and nuclear power generation both in this country and elsewhere. If we could steer some of the design concepts in this area, the result would be technologies highly adaptable to the Moon.

David Graham < Woollym@aol.com >

Woolly Mammoth Co./ECS

EDITOR'S REPLY: Your suggestion is a great example of what I've dubbed "**spin-up**", pre-developing a technology that will be needed eventually on the space frontier, now, here on Earth for for-profit Earthly applications. Relatively free technology, ready to go or apply, when we need it in space is the end result.



Shielding with Bricks? [posted to artemis-list]

11/19/'95 With walls made of bricks or sandbags of lunar soil, and a roof made of <*mumble*> supporting more lunar soil, we can provide the same protection and still have access to the exterior surface of the habitat.

Some questions: How quickly does the habitat need to be shielded? Does it have to be accomplished during the initial manned mission or can it be done telerobotically after the first team leaves?

As far as brickmaking is concerned, do we know how to make bricks at the Moonbase using equipment that will fit into the first mission's mass budget? I thought brickmaking would involve producing a glass base product, melting it and using it as a bonding agent in the bricks. Is there another way? Maybe using the regolith's natural clinging properties and a gas operated pressurized ram mold?

Similar concerns for "sandbagging" lunar soil. Several hundred lightweight plastic and fiber reinforced plastic bags wouldn't weigh that much. But it would probably take a little time to fill them up by hand. The process could be automated but that means the machinery would have to be there to do it. Maybe a simple frame holding an electric vibrating hopper with a bag changer/end-closure device at the outfeed. Still have to have some sort of lunar earth mover to keep adding material to the hopper as well as a mechanism to remove and stack the bags as they are completed. Sounds like a system that would work best if there were people around to clear any malfunctions. Supervising it might be a full time job.

Simply piling dirt on top of the compound with a teleoperated scooper may be the best way to go at first. Although taking a brickmaking outfit and setting up business might do a lot to make people understand that we are serious about building a full fledged moonbase and that we are there to stay. You don't start a brick factory if you aren't serious about construction!

If it's essential to have external access to the first habitat then I suppose an aluminum frame could be set up like a spindly greenhouse (without the glazing) covering

the habitat. The center "roof" supports could be attached to the habitat itself. A reinforced tarp or blanket draped over the frame and the whole thing buried using the scooper. Won't be beautiful.

Jim Nobles <jnobles@sneezy.midtenn.net

EDITOR'S REPLY: Given the angularity of lunar regolith particles, tamping soil into a mold and lightly sintering it with solar heat or microwaves should produce serviceable bricks or blocks. Fiberglass reinforcement should not be necessary for most low performance applications.

If the first setup crew stays only a week or so, the amount of radiation they receive will be tolerable. So the shielding could be put in place telerobotically after the first crew departs and before the next arrives.

Your automated bagging process suggestion has merit. It will have to compete, in terms of equipment mass to be imported from Earth, with sinter-block making.

While simply bulldozing regolith is far the simplest method, it backs the moonbase operation into a corner so far as future expansion options are concerned. It may be wiser, as you suggest, to build a shed hanger and place modules underneath where they can be hooked up to one another in a growing complex with much less complication. See MMM # 89 OCT '95 "Shielding on the Moon: Digging in for longer stays."



No pity on those who stole the future!

9/23/95 - I finally got to see "Apollo 13" and it was a strange emotional experience. I was probably the only person in the theater who has actually ever met any of the people involved. So it was a lonely, personal event. I understood virtually every line of dialogue and knew so much about other events that were going on that weren't mentioned - the pogo, the problems convincing the computers that they really should do a sep with the LEM still attached - that I was there.

Ron Howard brought it alive and my own knowledge and my private memories from my days as a CMU Sophomore made it 1970 again.

And afterwards - blind rage. I left the theater and stopped for a pint on the way back. With every sip I cursed the political wanks who killed Apollo. May their souls be damned to eternal torment in the deepest foulest pits that hell has to offer. May dogs piss on their graves.

There is no smiley to this. I have no pity on those who stole my future.

Dale Amon <amon@walt.music.qub.ac.uk >
Belfast, Northern Ireland

**"Reach low orbit
and you're halfway to
anywhere in the Solar System."**

- Robert A. Heinlein

WORDSMITH CHALLENGE # 1 Name the boundary layer vacuum over the lunar surface. [MMM #91, Dec 95, p 1]

⇒ **Dorothy Diehl** <AstraDiehl@aol.com> "In the C.S. Lewis book, *The Silver Chair*, many of the inhabitants live underground. They call the place where they live the "Underworld". The place where others live on the surface, they call that the "Overworld". We could call that area of space directly above the surface of the Moon the "lunar **overland**". When we have vacuum tube trains or low altitude rocketed flying vehicles, we could call them "lunar overland vehicles" or the Lunar Overland Express."

⇒ EDITOR: to me, overland connotes "on" the surface rather than "over" the surface, and so doesn't fill the bill. But thanks.

⇒ **Garth A. Becker** <103323.2665@compuserve.com> "Why do you want to coin a new word keep it simple .. just say "**up**" and "**down**". The more specialized you make the lexicon the less people will want to learn and follow us."

⇒ EDITOR: Many of the worlds several hundred languages have only a couple of thousand words. Many have no technical vocabulary at all and you cannot get even a high school education in them, let alone a college degree - no textbooks. First class languages like French, German, Russian, Spanish have highly developed vocabularies of 100-200,000 words. English, however, has 650,000 words. It is no coincidence that English is the closest thing to a world language we have ever known. It got that way coining, adopting, or borrowing new words for new things and ideas - not by continuing to rely on existing words. Stop and think how many of the words you use would be unintelligible to Abe Lincoln or Daniel Webster. Fuselage, Carburetor, spark plug, trajectory, kleenex, shampoo, TV, videocam, jack, dead bolt, junk bonds, velcro, romex, vinyl, liftoff, dashboard, goalie etc. etc. Try to talk about any of these without using those words and using only words Lincoln knew. Then, get back to me if you honestly think that what you have come up with has made language "simpler". If we stop coining words, thinking to keep it simple by using ever longer and longer phrases, language will get more complex, not less. The problem I outlined was an aspect of the lunar environment that will be an "everyday" thing to people living there. They have the right to use a simple word rather than a phrase or acronym, or a word that means something else.

⇒ **Nelson Thompson** <nathompson@iwl.net> "One simple solution would be the word 'nair' - short for 'no air.' However, that's a bit clumsy and could be misunderstood. Then I remembered a seldom used word, a 'Southernism' actually, that I heard in my youth: nary. It meant 'not any.' As in, "I heard nary a bad word about him all my life." It's short, simple, not likely to be confused with other words, and has (had) a colloquial meaning not too different from what you wanted. The vacuum of space, even at the surface of the Moon, is literally 'not any.' So I suggest "**the nary**".

⇒ EDITOR: Runner up winning suggestion! Thanks

⇒ **Thomas Heidel**, Milwaukee WI - In MMM you regularly speak of the lunar surface as the "out-vac", a coinage probably modeled on the Australian "outback". In consonance with this I suggest simply "**the vac**".

⇒ EDITOR: I like it! *Grand prize front runner to date.* **PK**

Why most planets and asteroids have Clarke orbits, and most moons do not.

from the MMM Info Bank

The location of , even the very existence of surface-synchronous orbits depends on three factors:

- ◊ The **mass** of the planet, Moon, or asteroid in question
- ◊ Its rotation **period**
- ◊ Its **proximity** to deeper gravity wells

⇒ The more massive the body in question, the further out will be any surface-synchronous orbit, *all else being equal* the periods of the the compared bodies being closely similar).

Earth and Mars have similar periods or days of 24 hours and 24 hrs. 37 minutes respectively. Earth's geosynchronous orbit lies some 23,000 miles above the surface. The synchronous orbit for Mars, with only a tenth of Earth's mass, lies 10,500 miles above the surface. In contrast, a 24 hr. orbit above Saturn (95 times more massive than Earth) would lie about 160,000 miles above its cloudtops.

⇒ The slower a body rotates, the further out will be any surface-synchronous orbit.

If Earth rotated in 48 hrs rather than 24 , its synchronous orbit would lie nearly 39,000 miles above the surface [period² = distance³ (from planet center)]. Conversely, if Earth rotated in just 12 hours, its geosynchronous orbit would lie just 13,000 miles above the equator.

⇒ If the theoretical surface-synchronous orbit lies beyond the closest Lagrange point of a more massive body, a synchro-nous orbit will not exist as any object following such an orbit would fall into the dominant gravity well of the larger object.

The Moon's rotation period, locked to the period of its orbit about Earth, is a lazy 28.53 days. If the Moon were an isolated body off by itself, i.e. not a satellite of Earth or some other close and more massive dominant body, Its surface synchronous orbit, i.e. one with a period of 28.53 days, would lie about 55,000 miles out. In actuality, such an orbit would run over the shoulder of the Moon's gravity well into Earth's gravity well on the side facing Earth.

Most natural planetary satellites or moons have had their original rotations slowed, or speeded up, by overwhelming tidal forces until they rotation is locked to their orbital period, so that they always keep the same face turned toward their planet. Io, Europa, Ganymede, and Callisto always keep the same face turned toward Jupiter, Titan and its siblings, the same face towards Saturn, etc. Likewise, their would-be surface-synchronous orbits run over the lip of the gravity well interfaces with their host planet.

For communications on tidally locked planetary moons, there are **three solutions**:

- a. a constellation of satellites in swift close-in orbits;
- b. fewer satellites in very eccentric "Molniya" type orbits with their apogee (at which they move slowest and near which they spend by far the most time each orbit) above the place needing communications;
- c. relay satellites at planet-Moon L4 and L5 co-orbital Lagrange points, respectively centered some 60° ahead of and behind the Moon in its orbit about its planet at the same

distance from the Moon as the planet. For the Moon, L4 and L5 lie 238,000 miles out, fully ten times further out than Earth's geosynchronous orbit, meaning longer lag times and requiring more broadcast power.

the other hand, as small as asteroids are, their shallow gravity wells are far enough removed from those of more massive planets, that they can enjoy surface-synchronous orbits. Ceres, with a period of 9.08 hrs. has a Clarke orbit just 486 miles above its equator

PARADISE

[Continuing a Special MMM Series of Articles]

in the (new) beginning, ... (Starting over on the Moon)

This month, we continue our series of essays on the early days of a hopefully permanent manned lunar occupation, looking at "Pioneer Holidays", the self-selection drivers of lunan pioneers with the "right stuff", and what it takes to make a "permanent" outpost deserving of the name.

After a break next month to turn our attention to Mars, we'll resume this discussion of the first roots of what is sure to be a uniquely lunan culture in the April issue.

Meanwhile: !!!

Last month, in Moon Miners' Review #18, we were treated to a glimpse of an exciting new propulsion concept by NASA Lewis propulsion whiz Stan Borowski. "LANTR" promises to make the opening of the lunar frontier easier, more economic, and faster developing. Immediately below are the illustrations that should have accompanied that article.

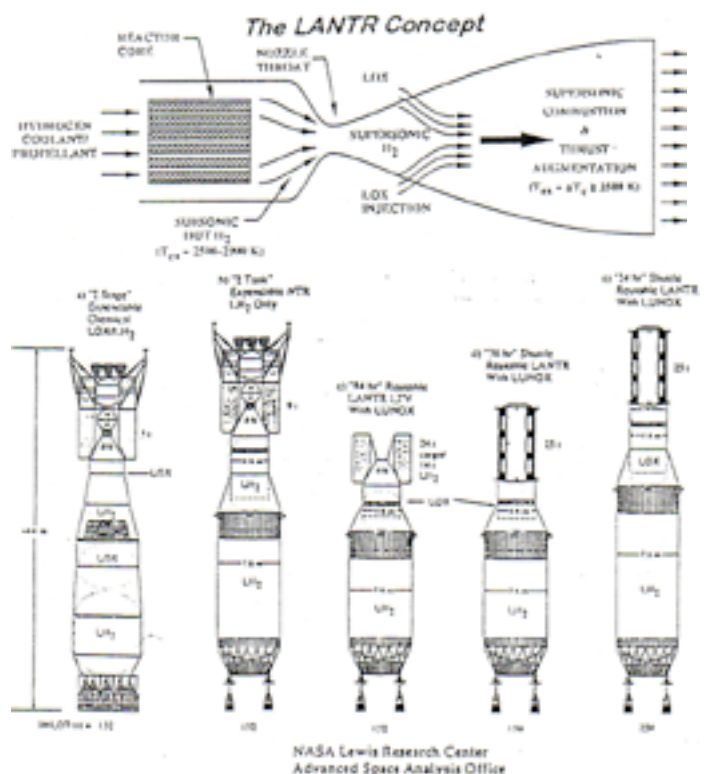



Pioneer HOLIDAYS,

and other festivities

by Peter Kokh

While “new traditions” (as oxymoronic as it sounds) are being made all the time, there is little doubt that those that command our observance most deeply are those which are oldest, rooted in our collective gitgo times. So it is with Holidays: Christmas, Easter, New Years go back millennia (two at least). Thanksgiving goes back nearly four centuries. The 4th of July will be 220 years old next time around.

We can expect that as the lunar frontier becomes fully established with the coming of age of the first native born generation of Lunans, the holidays and festivals they will most cherish will include those observed by those establishing the first beachhead.

The Apollo 11 landing (July 20th) is sure to be observed, as is the “infamous” day of retreat, the liftoff of the Apollo 17 crew (December 10th). But neither of these “trivia” dates will rival the enthused celebration of the “**Day of the Return**” when humans come back to the Moon intent on setting up an open-ended “permanent” presence leading to genuine settlement.

The first crew may only set up camp and then return to Earth, to be followed by the first crew intent on staying a full day-night cycle (the lunar “sunth”) or more. So closely connected with the observance of the Day of the Return will be the celebration of that first successful “overnighting” and the greeting of that first “sunrise” - “**First Night’s End**”.

Finally, “**Ever Since Day**” will mark commencement of uninterrupted human presence on the Moon. If I were to put a friendly wager on which of these will be the most honored in Lunan settlement tradition, it would be on “First Night’s End”. There will be a special flavor to this holiday, the shared mutual congratulations at having survived this “initiation” imposed by the Moon itself. And for all non-native born Lunans, there will be a special personal resonance with memories of their very own “First Night” and “First Night’s End”.

Other history-rooted anniversaries may mark the birth of the **first native born** Lunan. And later, the first native born grandchild (i.e. second generation, whose health will be the final test of whether or not humans can stay on the Moon indefinitely) [See MMM # 47 JUL ‘91, p. 5 “Native Born”]

Not all Lunan Holidays and festivities will take root in such historic occurrences. Some are sure to be bound up with the **Moon’s natural rhythms**, much as a growing minority of us terrestrials observe the equinoxes and solstices. Local **sunset** and local **sunrise** will be big deals, something to mark with a special meal or wine or friends - simply because they occur on a 28+ day cycle, not a 24 hour one.

If a particularly appropriate **Lunan Calendar** is adopted [see MMM # 7 JUL ‘87, “Moon Calendar” -

republished in MMM Classics #1], with “sunths” of 28.5 (24 hr.) days instead of 30.5 day calendar months, with the discrepancy with Earth reckoning made up with occasional “leap” (“intercalary”) “sunths” or weeks, Lunar New Years may only approximate the fall of New Years on Earth.

In such a case, the observance of religious feasts and holy days may also vary with that on Earth, without spiritual harm to those who honor them. This will be much to the chagrin and resistance of religious fundamentalists (those who give major importance to the minor, and minor importance to what really matters, and call every one else heretic and infidel.)

Solar Eclipses on the Moon are the flip side of Lunar Eclipses on Earth. They will be much more of an experience for Lunan pioneers and settlers than any eclipse on Earth (even total Solar). They will last several hours locally, and possibly may occasion the morning or afternoon “off” (work or school) as the case may be. And it will be the most favorable time for looking for city lights on Earth’s nighttime face.

In time, other “**political**” **milestones** will come to be honored in settlement tradition - the day when home rule is won, or independence declared, for example.

Historic and festive holidays will not be the only early-rooted traditions. **Pioneering songs and ballads**, even candidate settlement **anthems**, are sure to be written, sung, performed, and loved.

There may arise too special **festive foods** with historic significance. We have pretzels and crossover buns associated with Lent, unleavened bread associated with Passover. Eggnog, Christmas cookies, Easter Eggs, Pumpkin Pie are among many foods especially popular at specific festive times. On the Moon, many long-loved foods and recipe delights will not be available early on. Special early frontier substitute food and menu items, beverages too, even if in time the need to make such substitutions eases, may be prepared and consumed with relish on commemorative occasions. Associated with such holiday tradition meals may be time-revered toasts, blessings, and mutual greetings.

Certain **plants** are associated with various observances on Earth; poinsettias and mistletoe with Christmas, for example. And plants grown successfully in the early outpost days may come to be associated with various Lunan observances in like fashion.

The first humans to return to the Moon may think that all they are doing is erecting, deploying, setting up, demonstrating, testing, etc. But even the little incidental things they do, may in time take on special meaning and color not at all obvious at first, to become ritually repeated. This will all occur sometimes spontaneously, other times with alertness, if not deliberateness, as a part of fulfilling the very human need to impose on nature’s own rhythms, a festive and commemorative **cultural rhythm** of our own. Such cultural rhythms are a major element of the **social glue** that binds generations together. In this way they will bind future Lunan generations, much as similar traditions have always served in terrestrial communities throughout the globe, and throughout historic and prehistoric times.

PIPER

who will pioneer?

Leaving the familiar lush green hills of Earth for the Magnificent Desolation of the Moon for an open-ended stay won't appeal to many

by Peter Kokh

Space. Alien planets. As it starts to get real, it will also start to slowly dawn on media sci-fi-nurtured enthusiasts that the real thing is much less “nifty”, “neat”, “futuristic”, “utopian” etc., than imagined. The frontier will be a rough, hard place with few creature comforts, few opportunities for self-indulgence. We won't be stumbling on new aliens every week, indeed, perhaps never. Nor will we be visiting shining exotic cities.

Space, real space, offers little non-economic perks beyond one: the chance to start over, to start fresh, to have a hand in shaping the roots of a raw new community. Many immigrants came to America, Canada, and Australia with visions of making great wealth, and indeed some have done so. But many more came motivated by the lure of freedom. At first this conjures up images of political or religious oppression in the “old country”, but as proud as we may be of our political and religious freedoms, I suggest that this is only one type of liberty. Many more down to earth pragmatic people may have been drawn to our shores in search of another freedom altogether. Cultural freedom. Freedom from civilizations in which almost every aspect of life is stiflingly set. The freedom to start over. The opportunity to have a hand in shaping a new way of life.

When it comes to space and the call goes out for would be pioneers, not to go on some exotic mission, but to leave Earth behind, perhaps never to return, it is not those in search of the excitement that Science Fiction visions promise who will respond. It will be those for whom the futuristic, the ultramodern, the high tech, the super-sophisticated, the exotic, etc. means little. Those vulnerable to such turn-ons are best advised to stay on Earth, even as their spiritual ancestors stayed in genteel sophisticated Baltimore and other eastern cities instead of following Horace Greeley west.

Those first in line to volunteer will be those for whom the pleasures and gratifications of Old Earth have long become empty, for whom terrestrial creature comforts weigh less than the opportunity to roll up the sleeves and get the nails dirty building a raw new world up from scratch. Those who seek mainly to “consume” the “new”, will stay home. It is those whose bell is rung by the satisfaction of making very real personal “contributions” to an untamed infant world, to help polish the rough edges of this frontier one by one - it is these who will apply.

It will be tempting for governments, multinational companies, and other major players involved in opening the frontier to exercise a high degree of a priori control over who gets to go. Planners will say we need so many engineers, so many architects, so many workers. They will attempt to screen for personality problems. The temptation to “micromanage” who gets to go will be enormous. The need to micromanage will have many impassioned defenders. But!

But it is not the only way to go, nor is it consonant

with the best in our own time-honored traditions of individual self-selection. It can be argued that “we” can't just let “anyone” who imagines space or the Moon or Mars is for him or her to go - we'd get too many unsuitable people: antisocial types, alcoholics and addicts, criminals, psychopaths, “God knows what.” But there is another way to let personal freedom rule and still not end up burdened with a lot of unsuitable people putting a drag on struggling frontier settlement communities.

That way is to make sure that “self-selection” is “informed” self-selection. The public in general must be disabused of Sci-Fi-fed misconceptions about space. The dangers, the risks, the lack of creature comforts, the sacrifices and hardships, the substitutions and the do-withouts, the hard work, the isolation, etc. must all be drummed in over and over. That for every person willing to pioneer Antarctica you could problem find many thousands willing to pioneer Mars, a much less friendly place, is eloquent testimony to endemic mass misconceptions.

One public perceptions are corrected, replaced with the much harsher reality, far fewer people will be so eager to volunteer for the frontier. But those who do, all these reality checks notwithstanding, are far more likely to have the “right stuff” than any group carefully selected by micro-managers out of a flood of unenlightened mis-enthused volunteers. What we need is a philosophy, then a policy of “educated self-selection.”

This said, can we predict who will be more likely to volunteer, to have the “right stuff”? Much will depend on the life experience of the prospective volunteer. Climate, Culture, Education can all predispose on the “environment” side, irrespective of genetic or inherited personal qualifications.

Those from hardier climes

Obviously, those already happily adapted to hardier terrestrial climes will find life on the Moon or Mars far less depressing than those addicted to life in Earth's more idyllic and comfortable climatic oases. So it would not be surprising if among the “informed self-selected” settlement and frontier applicants we will find an above average representation of arctic, subarctic, north temperate dwellers, as well as desert peoples. We might expect them in general to be hardier, less deluded with expectations of paradise.

That means Alaskans and Canadians and Snowbelters and Scandinavians and Icelanders and Siberians and Eskimos and Patagonians and Falkland Islanders, etc. There are also temperate and tropic mountainous areas where life is challenged. Such places too may nourish the “right stuff”.

While there will be some sunshine oasis people, it would not be surprising if their ranks made up the bulk of disillusioned returnees to Earth. The Frontier will be rough. No offense to all you readers in California, the desert Southwest, Florida, and elsewhere where the “good life” is easy - but if you would shudder about a job-relocation to Wisconsin or Minnesota, perhaps you had better take an honest introspective hard look and think twice about early frontier space locations. And if you were born and raised in a hardier clime but have made a “life-style-motivated” relocation to a place where life is undeniably easier and more comfortable, an honest session of introspection may suggest that you confine your participation

and support of the movement into space to what you can do from “Couch Earth”. It will be a while, a very long while, before hardier folk have succeeded in building cushy utopian O’Neillian human zoo parks in free space. Once pioneering types seeking only the satisfaction of helping “start over, start fresh” have paved the way, and it safe for you to leave the womb world without danger of breaking a nail, we’ll let you know. Meanwhile marsupial type “Joeys” will find themselves more content closer to the pouch.

Cultural push and pull

The search for a place and conditions in which one can “start over” go hand in hand with the need to get away from a place in which one’s incentive and self-expression and opportunity to make a meaningful contribution are stifled. Those tired of paternalism, of over-direction, of suppression of initiative and resourcefulness; those unable to compete in a world where all the prize positions are already taken; those tired of too many arbitrary micromanaging rules; those ready to question the status quo and the given - among such will the spark of a dream to start fresh take hold, and overpower the hardships and sacrifices ahead. People who see no future where they are, are more likelier to see an acceptable open future where others, content with their present circumstances, would dread to go.

And then there are those who simply badly need the shot in the arm that only a major life change can bring: a new job amongst new fellows in a new place, without most of the rules set by people long since dead. People who’ve lived “one life” and are ready to start all over, fresh, where most all positions are open, where the future is less restricted, will appreciate the hard-won far-between rewards of pioneering. Space is a universe of places in which to start over, start fresh, start forgiven.

This country and others like it (Canada, Australia, New Zealand) were built by people leaving places they where they had never been able to “fit in”. Those that did “fit in” stayed in the old country. Blessed are the second best, for the same is true of individual plant and animal colonies pioneering new niches. What didn’t fit in in the old venue, works just fine in the new one.

Yet baggage happens. Some are “misfit” not just in reference to arbitrary stuffy sedentary cultures, but by any sense of the term. The problem is not with their surroundings, but with themselves. Some of those wanting to get away and start over, will prove to be just as out of stride on the frontier. Again, informed self-selection will tend to weed them out. But that is a separate problem.

The Melting Pot

Born before Pearl Harbor, I belong to a generation that was proud of America’s “melting pot” heritage, and abhor association with advocates of immigration damage control or even outright ethnic cleansing. Yet there are many space enthusiasts out there who in the closets of their hearts see the space frontier as a place to start fresh “free of” ethnic “undesirables”. Whether in groups, those so inclined will ever be able to put up enough money to collectively realize such a vision is questionable. It can hardly be argued that the more diverse the gene pool, the healthier and more creative and productive can

be the resultant civilization. Those willing to pioneer the frontier and possessing the “right stuff” will come from all over. It is likely that to the extent multinational government and/or business consortia are involved with the opening of the frontier, that it will begin, and remain a genetically open one.

What all pioneers will have in common - a vastly new, untested, and challenging frontier - will be much more intensely felt and immediate than any of the national, cultural, or ethnic culture traps which worked to keep them apart before. The more quickly a new frontier culture arises and the more depth it has, the easier it will be to forget the past cultural roots and immerse oneself in the new.

Talent, cultivated skills, and training

Being hardy and being driven to trade the comfortable old for the hard-going new, will not be enough to land anyone a spot on the front lines of the space frontier. You can’t drive to the Moon in your Ford, nor fly there in your Cessna - let alone saddle up the old mount or hitch a ride in a covered wagon or stage coach. It will take a small fortune to go, and for most that means finding a frontier-based employer willing to pay one’s fare.

Self-selection will have to be active, not passive. One will aggressively have to seek training and education, perhaps in multiple fields, if one is to have any hope of fielding a winning resume. People with double, triple qualifications in needed fields will have the edge, not just to be able to pinch hit in emergency, but able to do double duty from the start. For on a frontier, there are always more things needing to be done than there are people to do them. An outpost with a dozen people, may have two dozen jobs needing to be done. And it will be that way for a long, long time.

The frontier will need more than technical skills in manufacturing, mining, construction, engineering, etc. For morale’s sake it is important to humanize an alien location as soon as and as pervasively as possible. Pioneers with artistic or craftsman talent, singers, musicians, dancers, comedians etc. able to forge a new frontier appropriate culture. It will be a long time before the frontier can afford to import dedicated artists and performers. What is needed is the person who can do the technical job during the day, and fill the artistic and entertainment function after hours. So get a double masters with on-the-job double experience, and hone those creative talents too boot, and you’ll have a great chance.

To the prospective employer, experience *is* a seller. People with a record of successful problem solving, finding new pathways to get a job done will have a leg up. Those who accept without complaint the challenge to adapt, substitute, make do, improvise, invent, and otherwise demonstrate strong resourcefulness, will be especially impressive.

The frontier will require both leaders and followers. But it will especially need the “self-led”, the self-driven, the self-motivated. Indeed, self-selection starts here. One not only has to “want to go”. One has to want that “aggressively”.

Yet, an element of luck will always remain. One has to be in the right place, and at the right time. For many of us, no matter how high we score in the “right stuff” department, time will prove our enemy. The frontier will not open soon enough.

RAMA



Permanence has to be earned, not proclaimed

by Peter Kokh

“Permanent!” You would think its is a cut and dried word. But like all adjectives, its denotation can be justified in degrees. Sure, it’s not at all what we mean when we use the term with reference to our presence on the Moon, but in a sense our presence is already permanent. Even if we never return, indeed especially if we never return, the Apollo astronauts will have left a relatively “permanent” human presence on the Moon. Their bootprints, tire tracks, and assorted left behind equipment and paraphernalia [lunar museum hope chest] should outlast all of us individually, outlast, indeed the most long-lived of the current family of terrestrial nations. It will simply take that long for the process of micrometeorite rain to “garden” the surface at the landing sites to remove all traces.

But that’s not what we mean. The Apollo crews were just on “scientific picnics”, our happy campers taking their lunar module “tents” with them when they lifted off. The next “small step, giant leap” (to use the slogan of the upcoming New York International Space Development Conference - you all come , now!) is for the next returning crew to leave behind a habitable structure, protected from the elements by a blanket of moon dust (regolith) shielding. That goes much further to merit the description “permanent presence”.

Let’s quibble no more. What we all mean, *want*, is to plunge into a new era, one in which from that day forward, there will never again be a sunset on a moon without humans working and living there somewhere. For the more easily satisfied, the less expectant, that means no crew will ever return to Earth without first being replaced.

But to the rest of us, this is a wooden nickel. What we mean, *want*, by “permanent presence” is real settlement communities in which a significant part of the population has come to (and someday been born on) the Moon fully intending to live out their lives there, raising families, having children, working for their livelihood, and doing the whole spectrum of human things we call living. Now, in that sense of the term, we are talking about an era of much more ambitious activity on the Moon than are those folks happy to have an Antarctic style government/science outpost with rotating crews.

Our point in this essay is that we can’t get to this higher realization of the term “permanent” from day one of our return with a habitat module, without *the right set* of plans, without *the right* official (government, multi-national industry, or private undertaking — i.e. the chief responsible party in charge) “*philosophy*”. Philosophy, shunned as irrelevant or useless by self-styled pragmatists, is, whether its principles are sound or loony, the most powerful force on Earth. Everyone operates with an implicit philosophy, even criminals and misfits. As hard to pin down as it may be, as difficult to agree upon as we know it is, is still the ultimate fuel that powers and drives (steers) everything in human activity and history. So it

is worth paying attention to, worth trying to get it right, appropriate, and productive of results.

We must sell, and buy, “the ladder” of permanent presence on the Moon, as such — *as the whole ladder*. It has been, is, and forever will be, a failure-guaranteeing philosophy to attempt to neutralize potential opposition by selling the dream one seemingly innocuous rung at a time. When we do so, the rung gets designed by a committee with many of the players oblivious of the nature of the rung to serve as a step to another rung, and on and on. Look at our recent past. First, not to alarm anyone, we sold the idea of a space shuttle. That in place we introduced the idea of a space station. That now seeming to finally have a momentum of its own that will lead to its at-long-last realization, many of us are beginning to agitate for a return to the Moon and a first expedition to Mars.

The trouble is, the space shuttle we ended up getting was designed by a committee many of whom did not consider the need to maximize its design so it could best serve as a shuttle *to a station*. Repeating our mistake, the station, in each of its design iterations, has again been designed by a committee, most of whom have not considered it important to maximize the station as a platform *whose primary function* is to serve as a springboard for deep space missions beyond LEO and GEO to the Moon, to Mars, to the asteroids.

And so we have an ultra expensive shuttle with which we have to make do, and will get an even more expensive station downward looking in design and function (an easier sell to those to whom we were too timid to close the real ladder).

If we follow suite, the first lunar outpost will be an end all in itself, poorly designed for expansion, or to support the kind of ambitious experimentations and demonstrations needed to properly design expansion phases. If we do sell the outpost, once again it will become a self-halting step forward. We will indeed have gained only an inadequate high tech shelter that *will be* abandoned at the next budget crisis. So much for “permanence” - a permanent “ghost townlet”, eventual “ruin”.

That’s why it is difficult to see the sense of political space activism, aimed at programs rather than at legislative facilitation. The political process by its very nature *cannot* produce anything intelligent.

A commercial, industrial undertaking has much more of a chance, even with myopic MBAs running the show. A for profit enterprise or multinational is far more likely to design and plan in a way that leads to growth - and real permanence. Who has the deepest pockets is an irrelevant consideration. *Rather the question is who has the drive, the persistence, the absolute need to succeed?*

A government operation would put primary stress on science while doing *token* experimentation in the practical arena of learning to live off the lunar land. It will have saved money up front, and the resulting “mule station” will indeed be sterile, in no way pregnant with the future.

So agitate not for a “permanent outpost”. See to it instead that legislative and treaty roadblocks are removed, that economic incentives are in place. Then we will get a town built brick by brick, settler by settler for the long haul. Not just a permanent ruin-to-be.

Paraph

[Introducing a new MMM feature column]

MOON ZOOM

Exploring the Moon by Telescope:

Cheap, and Personal Access to a Waiting World

by Thomas Heidel, LRS

Introduction

For the price of a modest backyard telescope, nay, even cheaper, for the price of dues in your local astronomy club, you can book private passage on a fast-as-light space ship that will carry you at will over the lunar terrain, lingering here and there as its craters and frozen lava seas and rilles and scarps and rays catch your eye. You can watch the patient march of the sunrise or sunset across this "magnificent desolation". You can people it with your mind's eye. And you are really there, up close, not watching a video - really there. Night after night, as the Moon slowly turns into the sunlight and then into the stardark, this fascinating future home to human pioneers will reveal ever more of herself to you.

Books

Go to your public library and check out one of several books on observing the Moon. Or order "**The Moon: An Observing Guide for Backyard Telescopes**" #18534 from Kalmbach Publishing Co., Dept. AC125, 21027 Crossroads Circle, P.O. Box 986, Waukesha WI 53187-0986. \$11.95 plus \$4 4th class mail, \$4.50 UPS. MD and WI orders add 5% tax. Credit Card orders: 1-800-533-6644; (414) 796-8776.

Telescopes

The Moon is very bright - you do *not* want a large aperture "light bucket" telescope. Longer focal lengths and a set of good eyepieces and a glare filter will start you out right. Even a department store 60 mm scope (e.g. Tasco) will give you much pleasure, revealing craters and mountains. The Moon is easy to find, easy to follow, *manually*. No Setting circles or electric drives needed. Orion and Meade sell F8 6" Dobsonian telescopes for \$319 and \$325 respectively. Such a scope is also good for sky browsing ; star clusters, nebulae, comets, etc.

Local Astronomy Clubs

Sound advice is to join your local astronomy club. After using the club's and various members' telescopes, you will have a much better idea of what kind of scope to buy, if in fact, you want one of your own. How to get in touch? Call your library information desk. They often keep lists of special interest clubs and associations. If this doesn't work, write to **Astronomy Magazine** at the Kalmbach address above. They keep a very complete and updated list of local astronomy clubs with contact information.

Starting this month

Each month we will have a one column look at some feature or area of the Moon easy to observe with modest equipment. Many of these will be timeless reprints from past issues of **Selenology**, quarterly of the American Lunar Society. ☒

See Tranquility Base through your own Telescope

by Craig D. Wandke, American Lunar Society

[Reprinted with permission from Selenology, Fall 1995]

You can locate the Apollo 11 landing site with your own telescope! NASA's choice of the location that would come to be known as Tranquility Base, the site of humanity's first extraterrestrial venture onto the surface of a body other than Earth, in July of 1969, was the result of many factors. Most important of these was the safety of the astronauts. (remember JFK's "... *and return them safely to Earth*" ?) which included orbital mechanics criteria for ascent to lunar orbit, communications considerations, and the absence of mountainous terrain.

Apollo 11 landed in the eastern section of the Sea of Tranquility in an area not far from the craters **Sabine (S)** and **Ritter (R)**. The area is characterized by flat terrain and the absence of dangerous highlands which would have posed a possible navigational threat to the inexperienced moonmen.

Tranquility Base (**TB**) is slightly south of a point one third of the way *from* the above pair of craters *to* the crater **Maskelyne (M)** [The Maskelyne-Sabine-"Statio Tranquilitatis" angle is about 30°.] All three are about 16 miles in diameter, so all are visible with amateur telescopes, *beginning at about 90x* [90 power] under stable seeing conditions. Remember, that everything appears inverted in your telescope eyepiece. Thus south will be up, and west to the right.

[Another way to find the area is to look for the apex of an equilateral triangle anchored on the crater **Dionysius (D)** to the WNW and the crater **Arago (A)** to the NNW **TB** is located to the upper left of **A — D** in your field.]

The *map section below has been flipped*, top for bottom, to show how the area will look in your telescope.



The whole area will be best for viewing *a day before* first quarter [e.g. Feb 25, Mar 26, Apr 24, May 24] and then again *about two days before* the last quarter [e.g. Mar 10, Apr 8, May 8]. Since the mare material of Tranquility is dark, all three craters tend to be fairly obvious under the Sun's early morning and late afternoon rays at the suggested phases.

The flag (*any* of the actual equipment) is invisible, of course. What is visible is the general *area*, and so, with your telescope, a careful eye, the information on this page, and clear whether, you can see this historic area of the Moon through your own telescope! Happy viewing!

CDW

Moon Guns & Other Mysteries

by Gregory R. Bennett

CEO: The Lunar Resources Company,

“Chief Responsible Party”: “The Artemis Project”

Jan. 20th, 1996 - from: grb@asi.org

To: ederd@bcstec.ca.boeing.com (Dani Eder)

CC: kokhMMM@aol.com (Peter Kokh, for MMM)

About Moon guns . . . As it happens, I even have some thoughts about the subject at hand.

The idea of building a chemical gun to launch propellants from the is intriguing, but I'd shy away from comparing it to an electric gun. We're faced with it's own interesting technology challenges. As best I can tell, to make a chemical gun work we'd need all the industries required to support an electromagnetic launcher, plus a lot more. Here's what I'm thinking. Correct my concept of this thing if I got it wrong.

Propellants . . .

The first issue is making the propellants from lunar material. You mentioned the lack of nitrogen on the Moon. Some nitrogen is mixed in with the regolith, but exporting scarce, life-critical elements from the Moon would be a self-defeating business.

Ditto for the idea of exporting hydrogen. You mention using hot hydrogen as a working fluid in one of your posts, but I'd advise against it. If you start a business that wastes hydrogen on the Moon, it will last just as long as it takes other Lunans to wreck it. The stuff is too precious.

The good news is that there are lots of ways to make propellants from lunar material. You need a fuel, oxidizer, and perhaps some other elements to control the burning rate. Any mixture that gives you gasses which will support a supersonic burning wave front (a Chapman-Jouget wave) will work.

The hard part is getting that mixture. We'll have to disassemble Moon rock to do this. To get the oxygen we're exporting, we'll need essentially the same processes. Chemically the function of the gun is to reassemble the compounds we took apart. But making propellants for a chemical gun means additional chemical processes, all new technology that will have to be developed at some non-zero cost.

Once we make the propellants, we'll need containers, for storage, logistics, and getting the propellants into the gun. That means more manufacturing processes, more machining, more technology to develop.

Gun Structure . . .

Here it gets really complicated. We need a precisely machined barrel, able to contain some pretty high chamber pressures. It'll be miles long unless you're willing to build your payload to withstand thousands of g's.

A fuel tank robust enough to take that kind of acceleration is a whole new engineering challenge. It wouldn't be useful as a container for rocket propellants and in this scenario won't be recoverable, so I assume you don't want to do this.

That leaves us with the metallurgical challenge of making the material for the barrel, and then machining it. Now we're into really heavy industry on the Moon. I don't have time to estimate the initial capital required to get that much heavy machinery to the Moon, but just the thought of it boggles my mind. (And you know my mind doesn't boggle easily.) The

alternative is building up heavy industry on the Moon one step at a time, which adds a few decades to the program schedule.

Conclusions . . .

Based on the technology challenges and capital required to develop that big chemical gun on the Moon, my best guess is that electromagnetic propulsion would be considerably better-faster-cheaper to implement. Linear induction motors are fairly straightforward so the technology isn't scary. The important structural components -- supports for the magnets and payloads -- are massive but don't need to be as precise as a chemical gun's barrel; we're not building a giant pressure-containing cylinder.

The basic industries supporting either operation involve mining moondirt, separating the chemicals, and making metal; and both need a good power supply. For electromagnetic propulsion we're ready to go when we can make aluminum wire and machine the fiddly bits that keep the parts together. We'll even need wire to support control of the chemical gun, too. The chemical gun needs much lower power levels for its operation, but the fundamental industry is the same; we're still smelting aluminum and extruding it through a die to make wire.

Nevertheless . . .

All that said, I can still think of an economic argument for the gun: it looks neat. The muzzle flash against a dark sky would be awesome; you'd *know* something is happening when that behemoth fires! It might even sound neat if the ground shock gets transmitted to a nearby habitat. So even if it takes more industry development to do it, a big chemical gun might be economically Worth Doing because its entertainment value might add enough to make up for the cost of developing the additional machining capability. In comparison, an electromagnetic launcher would be *boring*. Think of it as an attraction at the Great Theme Park In The Sky.

One more argument in favor of doing this: These days we flinch at the word "spinoff", but the additional industrial capability we'd get from being able to do all that heavy machining should spark your imagination. If we can make a cannon barrel on the Moon, we'll be able to make just about anything.

GB

cartoon by Neil Durst, ASI Pittsburgh

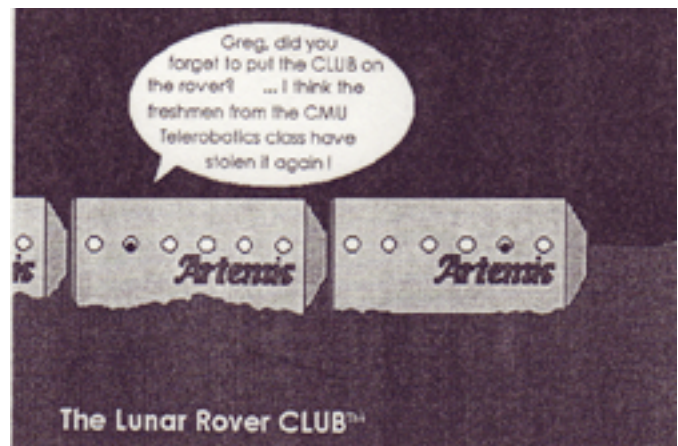

A Space Frontier Tech Demo Program IDEAS for Lo-budget, 2 yr.-feasible demonstrations of technology items that will be needed or useful on the Lunar Frontier.

[The following suggestions by no means exhaust the possibilities and readers are encouraged to think of, pre-brainstorm, and report to MMM of other neat doable projects that will help bring home to all of us, veteran space enthusiasts and general public alike, the concrete doability of space pioneering on the Moon, Mars, and elsewhere in the Inner Solar System.]

Moon human-powered Trike

See MMM # 91, DEC '95, page 9, column 2.

Silane Producing Sebatier Reactor

Silane, SiH_4 , is a fairly high energy liquid silicon analog of methane. Combining Moon-scarce hydrogen with Moon-abundant silicon in this way, extends the payload lifting power of hydrogen by six times. Silane is a top candidate lunar-appropriate rocket fuel for suborbital hoppers and Earth-Moon ferries, and lunar surface to orbit shuttles.

Silane could also be burned with lunar oxygen in an internal combustion cycle engine for lunar surface vehicles and electric generators for use at nighttime.

DESIGN, BUILD, and DEBUG a silane producing sebatier reactor. DEMO for ISDC '98 Milwaukee.

Silane Internal Combustion Engine

DESIGN, BUILD, and TEST an engine to burn silane and bottled oxygen in an internal combustion cycle rather than in a rocket motor cycle. DEMO for ISDC '98 Milwaukee.

Moon Motortrike

DESIGN, BUILD, and TEST a motortrike chassis to use a silane burning internal combustion engine. Trike should have wide track, wheels that lean into turns, and low center of gravity, along with 1 ft. minimum clearance. Possibly recumbent rider position. DEMO for ISDC '98 Milwaukee.

Atlasmobile

Assuming the availability of the same silane engine described above, design an "atlasmobile" on the order of the "atlasball" used on American Gladiators™ - a spherical cage moved by a Moon Motortrike or powered cart riding the bottom of a pair of circular tracks. See MMM # 81 DEC '94, page 1.

[Rego]'Lith moving Competition

DESIGN, BUILD, and TEST any of many possible types of teleoperable regolith moving equipment for us in emplacing shielding and grading sites, roads, and landing pads. DEMO for ISDC '98 Milwaukee.

"Turtlesuit" and "Turtlelock"

See MMM # 89 OCT '95 "Dust Control" p. 6.

The goal is not to design a pressurized functional "turtle-back spacesuit" but rather an unpressurized mockup with dummy backpack simply to determine and demonstrate the design factors that will allow its wearer to back up into a conformal turtle lock, effect lock and automatic inner door opening, pull his/her arms out of the suit arms, and reach up through the open back of the suit to be able to reach a grab bar on the inside of the habitat above the open turtle lock door, and thus pull him/herself out of the suit into the habitat.

This project can be broken down into at least two parts: DESIGN, BUILD, and TEST a turtle back backpack and conformal lock port in which the two engage and open together or in tandem, the habitat lock rim engaged with the "turtle-back pack "jamb" on the spacesuit. DEMO for ISDC '98 Milwaukee.

DESIGN, FABRICATE, and TEST, an open-backed suit in which the wearer can extract his/her arms easily from the suit arms and reach up out the back of the open suit. DEMO for ISDC '98 Milwaukee.

1/6th G Sport Simulator

Traditional Earth sports will not translate well to lunar conditions of "sixthweight" wherein everything weighs only a sixth of Earth-normal but retains full Earth-normal mass and momentum. Traction and maneuvering will be difficult. Instead of tragicomic caricatures of familiar sports, we will need games that play with the grain of lunar physical constraints, including small volume pressurized spaces.

DESIGN and TEST a computer simulation program which combines sixthweight gravity with full momentum in which to simulate any number of game and sport plan ideas. DEMO for ISDC '98 Milwaukee.

Lunar in home telescope

DESIGN, BUILD, and TEST an amateur telescope design in which the image gathering components are on the lunar surface, but in which the image is available, without electronic transmission, to the telescope user within his/her pressurized habitat below. DEMO for ISDC '98 Milwaukee.

The game plan:

- Gather a team with the right mix of expertise,
- brainstorm a design
- price the materials and tools that you will need
- make a presentation to potential corporate sponsors

Each Group is responsible for raising its own funds and locating its own corporate sponsors. Some assistance may be available to help transport your device to the '98 ISDC in Milwaukee. The ISDC will endeavor to provide project review.

Any group attempting to put together such a project should register with the

Tech Demo Committee, ISDC '98 Milwaukee
P.O. Box 2102, Milwaukee WI, 53208

Further Information:

Peter Kokh (414) 342-0705 eves, weekends
kokhmmm@aol.com

ISDC '98 MKE

Mail Box

✉ **Frontier Musings** [cf. MMM # 91 DEC '95, p. 6 "Personnel"]

Sometimes, when I'm musing about the mechanics of lunar settlement, I wonder if we can avoid the "lawless" element that was so much a part of earthy frontiers. On Earth, while life on the frontier was not easy, one generally could live off the land in isolation from others. On the Moon, the frontier physically is much more deadly. I would hope that this very real danger would cause a much more highly developed sense of teamwork, partnering, brotherhood, or, in a word, family among those that would dare to venture out from mother Earth.

The physical constraints of early lunar settlements will require a constant monitoring and vigilance by each team member of the others supporting technology to insure survival. Most all endeavors, especially those related to "outside" will have to be two or more person team efforts for safety reasons. Hopefully a culture will develop from this where each member's behavior is guided by a sensitivity and concern for the welfare of each member of the community at large. Crime, at least the personal, violent types of crime should be relatively rare. Not because of some rigid, police state mentality, but because we recognize that we are individually weak against a powerful and hostile nature. Our only hope of survival is in viewing each other as part of ourselves and caring for each other as we care for our own flesh.

David Graham
<woolym@aol.com>

✉ **Lunar bars**

[cf. MMM # 87 JUL '95 p. 10, "The Brass Spittoon" - republished in MMM Classics #9]

[from a post 11/19/'95 to artemis-digest@lunacity.com]

And at the Artemis Ireland reunions we can sit around the turf fire screen saver and sing old songs like *The Rising of the Earth*? And declare it a bohdran free zone?

But there is a serious side to this. In the earliest days it will be more like a wartime military post. But as it grows into a frontier outpost, a good pub will be important to sanity. And thought will have to go into the design of it so that a good tension releasing bar brawl will not leave anything damaged that is either irreplaceable nor will it risk the integrity of life support.

A frontier settlement has a psychology to it. And although I don't want a bunch of social engineers trying to apply academic theories to "designing" the people and society there, I do think it is necessary to apply common sense that any expedition head, military leader or old time US sheriff would have. People who go to frontiers have cut a lot of ties and

will have a burden of memories of things left behind; they will be in an unforgiving environment in which a slip on their part or that of another, or a random failure in equipment or procedure can maim or kill; there will be little to do but work and it will seem like there is so much to be done that it is a hopeless task; people you have grown to despise can not be avoided; relationships that failed can never be completely left behind... in general it will be a high stress environment. This is not to say that people will be going around frowning. Frontiers are also exciting and fun. But the invisible stress still builds and there must be socially acceptable outlets for it. Otherwise we'll end up with a town full of coronaries, neurotics and axe murderers.

So when I said "a good tension relieving bar brawl", I meant just that. Anyone who has ever lived in a seriously tense situation will understand all. People in Northern Ireland are particularly familiar with the both coping strategies and the results of failure to do so.

Dale Amon.
<amon@walt.music.qub.ac.uk>
Belfast, Northern Ireland

MMM #93 - MAR 1996

By the light of a smaller, dimmer, cooler Sun



← LEFT: On Earth, the Sun shines bright and warm. Our generous oceans act as a thermal sink for that heat, providing an additional mean boost of some 50° F (28°C) over where we'd be without them. Solar collectors do not have to be overly large to tap this energy further.

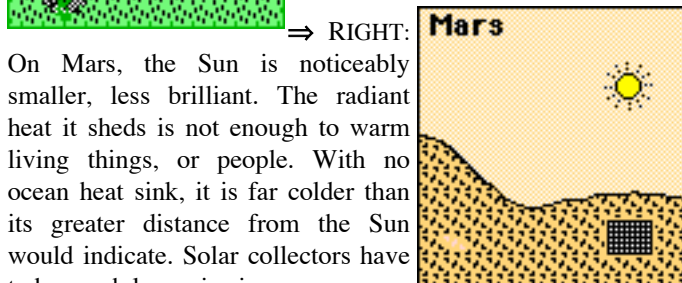

⇒ RIGHT: On Mars, the Sun is noticeably smaller, less brilliant. The radiant heat it sheds is not enough to warm living things, or people. With no ocean heat sink, it is far colder than its greater distance from the Sun would indicate. Solar collectors have to be much larger in size.

IN FOCUS Mars will require a harder breed of pioneer

Many people envision with enthusiasm an eventual wholesale settlement and colonization of Mars, and I number myself among them. In doing so, we carry forward what has become a racial dream of our species throughout this century. And we have done so, stubbornly, through revolution after revolution in our perceptions about the Red Planet. Banished to the realm of myth are the Mars of Edgar Rice Burroughs, populated by green men and princesses and thoats, and the

Mars of Percival Lowell, crisscrossed with canals feeding green strips of irrigated vegetation, defying the creeping desiccation of the Planet. But gone too is the glimpse of a moonlike Mars that we read into the photos from early Mariner orbiters.

We know now that Mars *was* once warmer, wet with ocean, rains, and rivers, and lakes, and possibly in early stages of greening. We are all but certain that much of that watery endowment yet remains, locked up in permafrost layers of soil in lower lying basin lands. There may even be liquid subterranean lakes *if* there are near-surface geothermal pockets still simmering here and there, but we do not know. As to the polar caps, we now know that under a few inches of carbon dioxide frost seasonally chilled out of the atmosphere, there are vast polar ice sheets hundreds of meters thick, at least in the north.

How much water is there? That is, how extensive and patchy are the permafrost deposits? How thick are they? How fresh or brinish? All these questions must be answered to a first approximation accurate to an order of magnitude before any brainstorming schemes of “terraforming” (or, as we would prefer, of “rejuvenaissance” i.e. not making Mars *like Earth*, but bringing it back to the more encradling *Mars-state* it once enjoyed) can be much more than an exercise in “garbage in, garbage out.” Which is why MMM has never gotten into such schemes. It is far too premature an exercise.

What does remain is the promise of a world that *is* more thoroughly endowed with prerequisites to support human and Earth life than is our own bondsworld, the Moon. Mars would seem to have far more appeal as a homesteading destination for those with enough of the right stuff to be willing to forever forsake the Green Hills of Earth.

But we can indulge in these fantasies, these declarations of willingness to go, only because the need to take a second look has not been thrust upon us by any immanent opportunity to open this frontier. That point of truth is still over the time horizon by an unknown number of years.

When that time does come and those who’ve thought themselves ready to go are faced with the decision to “put up or shut up”, we think that many, even most, will get cold feet.

For despite Mars’ life-supportive endowments, the challenges and obstacles to the establishment of a long-term human population capable of first enduring, then of thrivingly coming into its own, are daunting. And they are daunting from many points of view: engineering, logistical, biospheric, but above all and most critically, personal.

It is this last but ultimately most make-or-break class of challenges that we want to discuss here.

POINT: Mars is farther from Earth than the Moon, *much* farther. And the implications are *compounded*.

Size: (Earth) Moon Mars	Dist. from Earth (Mn=1)	Dist. from Sun (E=1)	Heat & Power from Sun (E=1)	Launch Window Resupply Frequency	One way transit times
	1	1	1	daily	1-3 days
	150 to 1,060x	1.38min 1.67max	52%max 36%min	every 25 months	6-9 months

Resupply, reinforcement, relief, and rescue are always from 6 months to 25 months away. This will mean a reliance on a strategic “egg yolk” policy, as opposed to maintenance of “umbilical” style logistics. On site repair and fabrication shops as well as hospitals, both as to equipment and personnel expertise will need to be very much more complete. **Triage** in medical emergencies *will have to be accepted by all* as a potential *personal consequence* before leaving Earth.

Resupply, reinforcement, relief, and rescue are always from 6 months to 25 months away. This will mean a reliance on a strategic “egg yolk” policy, as opposed to maintenance of “umbilical” style logistics. On site repair and fabrication shops as well as hospitals, both as to equipment and personnel expertise will need to be very much more complete. **Triage** in medical emergencies *will have to be accepted by all* as a potential *personal consequence* before leaving Earth.

It will mean that the personal commitment to the Mars frontier of each pioneer recruit must be individually that much deeper, more “final”, that much less open to reconsideration down the line. It will be much more expensive to return to Earth, and the delay time before such a repatriation can be affected will be much, much longer. Only the hardest, most self-reliant, and resilient personalities should tempt such odds.

Felt isolation from the mainstream of human civilization will be much deeper. Electronic communication with Earth involve response delays of 6-44 minutes, not the 2 plus seconds Lunans will experience. While, in all but live radio communications, those delays can be edited out, the edited conversations will flow jerkily and clumsily. The new “Martians” will tend to turn inward culturally and socially, and go their own way.

POINT: The Sun not only is further, dimmer, and much less warming, *it is noticeably so to the naked eye*. Not all of that is bad, of course. On Earth, full sunlight is uncomfortably intense. On Mars the *softer* light will be still plenty bright enough, and welcome, much as the softly sunny November skies in the northern United States and Canada.

But the smaller Sun [see artwork on page 1, bottom] will be a constant reminder of the reliefless cycle of very cool and bitterly cold seasons. Martian summers are but caricatures of our own temperate zone warm seasons, not even quite on a thermal par with the patchy thaws of our Antarctic summers.

The new Martians will learn to cope and grow to find much pleasure and satisfaction in the accommodations they need to make to acculturate themselves to this new world. But only those with the inner strength and drive to make the enormous adjustments had better set out on such a venture.

It can best be summed up so. Only a tiny fraction of the numbers who say they would go to Mars had they but the chance to do so, would also be as willing to commit to pioneering the relatively far friendlier fringes of our own Antarctica, with its vast fresh water supplies, breathable sweet air, and surrounding oceans teeming with life and food. That has to tell us something. We are all too romantic about Mars!

Yet as long as the moment of truth reality check is yet far off, we can afford to indulge our Martian illusions. And perhaps that is *good in the long run*. For it carries forth the dream, and with it the ongoing brainstorming exercises that will *one day overcome* the daunting odds. **PK**

Good Reading on Mars

Astronomy Magazine, December 1995 issue, pages 36-43
"The Mars that Never Was" by Edmund A. Fortier,
Paintings by Chesley Bonestel.

< MMM's "Platform for Mars" >

⇒ Economic interdependence of several distinct mutually-trading off-Earth settlement communities is the only plausible path to viability of any of them.

⇒ The opening of Mars, its moons, Deimos and Phobos, along with access to near Earth and Main Belt asteroids, is vital to the long-term survival prospects of any pioneer industrial and exporting settlement on the Moon.

To this end, MMM sees the following developments as part of "the critical path"

⇒ **Mars Permafrost Explorer** — The opportunity to pre-test such a probe in Earth orbit to improve our knowledge of terrestrial tundra resources, makes this an easy sell.

⇒ **Ground Truth Permafrost Tappers** — Orbital surveys will not be much good unless calibrated by well-scattered on site drill cores. Further, only by actual on site taps can we tell either the percentage of water content or its freshness or salinity or how we can best tap the deposit.

⇒ **Mars Lavatube Explorer** — The opportunity to pre-test such a probe in Earth orbit to improve our knowledge of lava flow terrain, makes this a logical priority. The results could be far less important for geology than for future Mars settlement scenario options. Ancient near-surface Martian limestone caves could also be identified.

⇒ **Mars topographic map** with accurate elevations: from which basin and watershed divides can be traced along with their overflow dam points. From this potential primitive and immature drainage patterns can be sketched. This will help avoid siting an outpost in a future flood plain.

⇒ **Geochemical orbital mapper** — A refly of the instruments aboard Lunar Prospector.

⇒ **Geochemical ground truth probes** — We lack even rudimentary mineralogical analysis of typical Martian soils. Without this, the path of industrial development on Mars remains totally fogbound.

⇒ **North & South Polar weather station net**

⇒ **Antarctic Mars Training Camp Base** in one of the cold but "Dry Valleys" like **Wright** or **Taylor**. This should be a permanent establishment at which survival gear and methods developed for the Mars frontier can be tested, and prospective expedition members trained.

⇒ **"Redhouse"** Wild Flora Experimentation Projects. See the article with this name on page 5.

⇒ Adoption of the Zodiac-based **Mars Calendar** of Dr. Robert Zubrin as published in *Ad Astra* Nov/Dec, 93, pp. 25-7 "A Calendar for Mars", with the friendly modifications detailed in MMM #73, Mar '94, pp. 6-7. Support sought from: NSS, The Planetary Society, NASA, ESA, IAU {International Astronomical Union} Russian, Japanese Space agencies, SFWA (Science Fiction Writers of America)

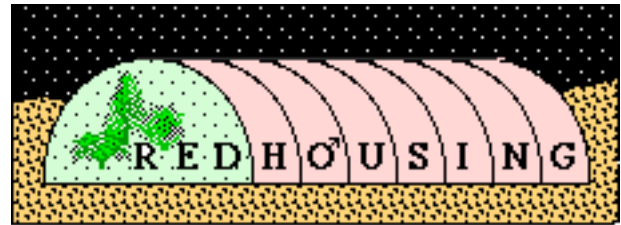

Breeding "Mars Hardy" plants in Compressed Mars Air

by Peter Kokh

In the previous "Mars Theme" issue, MMM # 83 MAR '95, on pp. 7-8 "Searching for OLD LIFE on Mars" (P. Kokh), we broke the topic down into two separate questions:

Question 1: What kinds of life forms may have had time to evolve on Mars before irreversible climactic decay, and could any fossil traces still endure?

Question 2: Could some anemic relic of a once far richer Martian Biosphere still subsist in "oases" here and there?

We concluded with a discussion of the implications for Martian settlement dreams, pointing out that the Romantics who hope against hope that we will find some primitive (at least!) life forms still extant life on Mars, had better hope that they are wrong. It is incomprehensibly naive to think that should we find life on Mars *of any sort*, that the political / rabbleocracy powers-that-be would allow humans (us!) to settle there. The Fourth Planet would forthwith be declared a quarantined biological preserve for the rest of time. "Humans and all Earth Life keep out!" We could hardly disagree more with the sentiments expressed by editor Jeff Liss in the recent issue of **Inside NSS**. He had called "disappointing" the recent finding that the Viking "No-Life-On-Mars" experiment results were not flawed after all.

If all we find are fossil relics and perhaps a few incomplete strands of DNA (we should rejoice at finding that much!) Jurassic Park type reconstructions of native life form populations are most unlikely.

If an ecosystem does survive, we could not hope to see *any significant further evolution* (beyond anecdotal differentational radiation of surviving species into new niches in a restored or rejuvenated more benign climate) within the lifetime of humanity, even if it be a million years - and *not even if* we succeeded in restoring, permanently, the former more life-accommodating climate with a stabilized all-Martian biosphere and biota. Romantic ideas to the contrary should not be entertained. We would be left with only pre-metazoan life, one-celled plants and animals - *nothing we could see with the naked eye!* So rather rejoice that Mars is empty of life!

It is not precise to say that Mars is "barren", only that it is "virginal".

That is not the end of the story. That Mars has no life, and quite possibly never spawned life even in earlier wetter and warmer times does not make the planet "barren". It only makes the planet "virginal". That conditions may have never been special to allow life to rise on its own, does not mean that life, originated elsewhere, and then bioengineered to fit Martian conditions, could not be successfully transplanted to Martian

soil, with intelligent guidance, corrections, and compensations. That is a tall challenge, however, but we hope to sketch how it might be accomplished. Or at least, the first steps one intending to green the planet might take.

The biological side of Greening Mars would have to be brought about "*pari passu*" i.e. *step by step together with* the geological rejuvenaissance of the planet. Rather than "terraforming" Mars by making it a copy of Earth, rejuvenaissance looks not at Earth, but the early Mars itself, for its standard of achievement. The planet does need to be warmed, first to the point where a third of the atmosphere no longer freezes out over the poles each winter (twice a Martian year, during northern and southern winters, i.e. paradoxically during southern and northern summers, i.e. atmospheric pressure is at its height only during spring alias fall). Warming it still further will free up additional carbon dioxide bound up at the poles or in permafrost year around. Both temperature and pressure have to be increased to the point that liquid water can exist in the open, even if only as seasonal dews.

But in this article, we want to look at the biological part of the equation. Obviously we want to, have to, use genetic material from sundry terrestrial plants (possibly animals too) and arrive at species hardy enough to survive and breed on a rejuvenated Mars.

What we have to start with is, species after species, a long ways from being remotely Mars-hardy. The harshest most demanding habitats on Earth are all much friendlier than the friendliest place on Mars, even possibly on the wetter, warmer Mars of yestereon. Where do we start? How do we proceed?

The most severe habitats on Earth are the deserts, the Andean altiplano of Peru and Bolivia, the tundra of northern Alaska, Canada, Greenland, Scandinavia, and Russia-Siberia, and the Antarctic islands, shores, and "dry valleys." No trees grow in these areas, not even the stunted, wind-grotesqued caricatures we find at the tree line on mountain slopes and at the tundra limits. Animals fare better, thriving on seafood, other animals and very lowly plants.

Animals, however, need an oxygen-rich atmosphere, which we don't have, have never had, on Mars. Plants, in contrast, thrive on carbon dioxide - it has been shown that most plants can be grown successfully in an artificial atmosphere of reduced pressure (e.g. 1/10th normal) of just carbon dioxide, the major component of Mars air. That is to say, that plants and crops can be grown on Mars in greenhouses pressurized with warmed Martian atmosphere, simply compressed tenfold - nothing else added, besides water, of course. That we could gradually lower temperature and pressure to meet the improving Mars climate halfway with bioengineered species that could be planted outdoors either to be tended and cultivated or left to grow wild is the general idea.

We call this redhousing, rather than greenhousing. We are using the air of the red planet Mars and an improved but still Martian climate - not the air of Earth and an idealized terrestrial climate. This is not to say we shouldn't have traditional greenhouses on Mars. We do have to eat and clothe ourselves and provide for pharmaceuticals and other needs, day in and day out - *while* we are busy in the redhouses preparing to mate a rejuvenated red planet with a blanket of life bred and

engineered to go native there.

Will there someday be forests on Mars, with real trees even if they look unearthly. That's a possibility beyond our vision. Our starting point will likely be the lichen, a moss-like plant that is basically a fungus able to survive thanks to a symbiotic relationship with green algae. That this feat is cooperative is discouraging, that we have to start with a very specialized complex - compound creature. The best place to start in any plan to evolve a radiant family of diverse species is with something very generalized, able to survive in a wide range of habitats. But thankfully, we have many species of lichens in the northern hemisphere and a few in the southern.

But are lichens the only starting point? Not necessarily. Many plants handle annual freezing in stride, but the much longer, much **deeper freezes** of Mars would likely be to much for them. Witness the tree line!

Some antarctic organisms in the animal kingdom, come equipped with an intracellular antifreeze - glycol. But plant cells have protoplasm as well. If the gene responsible for the ability to produce glycol can be transferred successfully to some plants, that might give us additional breeding stock for Mars. The more starting points, the more diverse the ultimate possibilities, the more niches on Mars that can be greened.

But hard long freezes are not the only challenges Mars poses. Severe **desiccation** is another. Desert plants, like cacti and other "succulents" withstand prolonged very arid stretches well. On Mars the desiccating capacity of the cold parched winds is extremely intense. What the cacti and other desert plants have to offer, will not be enough. But it is a start. Nor is there any reason why the glycol gene cannot be added to the genetic consist of desiccation-hardy plants, and vice versa. Chile's **Atacama**, California's **Death Valley**, NW China's **Takla Maklan** are among the most challenging niches for desert life.

And then there is the untempered **ultraviolet** of the more distant, cooler, Martian "Sun". Mars tenuous atmosphere without free oxygen (O₂) or ozone (O₃) is transparent to this tissue-killing radiation. Here on Earth, the most UV-resistant species are those that live at very high altitudes. The nearer to the equator, the higher up the maintain slopes does life thrive. Plants growing wild in various niches of the Peruvian-Bolivian *altiplano* (high altitude 13,000-15,000 ft. intermountain basin-plateau between the Western and Eastern Cordillera) may yield genetic contributors to this resistance. — a third ingredient.

We must add one more characteristic. On Earth many plants are pollinated by insects and birds. Bioengineering animals to breath a carbon dioxide atmosphere seems science-fantastic, not merely science-fictional. So we may want to end up with plants that are **wind-pollinated** or use some other assist than the help of sweet air breathing animal species.

The list of favorable attributes doesn't end here. We could select also for **abrasion resistance** to wind-borne dust, **low reproductive rates**, **interruptible life cycles**, etc.

What plant forms will be most receptive to such diverse genetic additions? Your guess is as good as mine. It is not impossible that the best Mars-hardy hybrids will have as ancestors plants that boast none of the assets mentioned, but will have proven receptive to all of them.

Nor do we have to wait until we are on Mars to begin the experimenting. There are so many candidate plants to start with, so many recombinant genetic combinations to be tried. The sooner we begin, and the more the facilities we set up, the sooner are we likely to have our optimism and enthusiasm rewarded - or discouraged.

On Mars, as we pointed out, all we will need is a shelter that holds compressed, warmed Martian air.

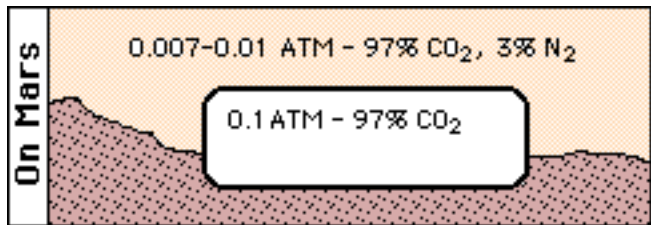

On Earth it will be a little trickier. Unbuffered, the facility would be subject to inexorable leaks from the higher pressure, vastly more oxygen-sweet air of the host planet:

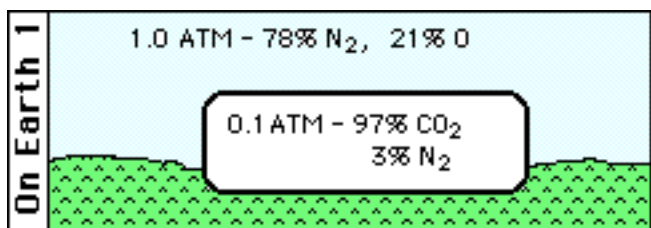

One way we can buffer the facility and prevent hasty degradation of the special atmosphere within, is to use a surround chamber with either Earth air or Mars air at relatively low pressure. Air would tend to leak out of the red house chamber, preserving quality, with makeup quantities from special tanks. If pressure in the surround got to high (too close in value to that of the inner chamber) the excess could be pump- exhausted to the outside terrestrial atmosphere.

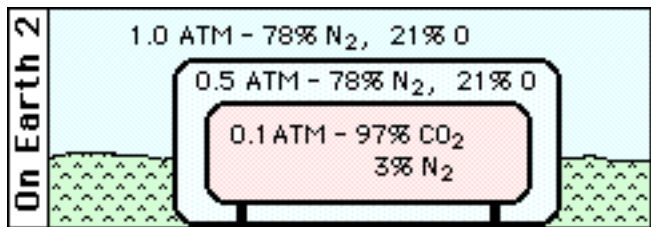

Or the redhouse could be covered and buffered by water in a host lake or pool or tank. This would also tend to prevent atmospheric contamination. A wet porch could not be used for entry, however, as oxygen dissolved in the water would outgas into the carbon dioxide atmosphere within, polluting it.

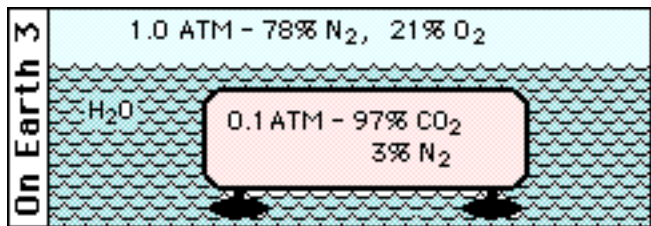

An Art of the Possible

The strategy is one of convergence, breeding ever more cold, drought, and UV hardy species for ever more Mars-like conditions in Mars redhouses. Meanwhile, outside the

actual Mars climate is improved by human activity and intervention. In fact, the degree to which these experiments are successful, will codetermine the goals set for rejuvenaissance of the planet. Like politics, the greening of Mars will unfold as the art of the possible. As politics should be (but isn't) it will also be the art of co-promise, not compromise - what can be achieved in improving the climate, temperature, pressure, and wetness of the planet - and what can be achieved by recombinant DNA biological engineering and breeding for Mars-hardiness. We can only speculate at the results.

The Role of Intervention

On Earth, and most likely on all life-bearing planets, evolution has not been smoothed. Each outburst of new species origination slows into a self-stabilizing rut, impeding further progress. It is the periodic decimation of existing species by comet and asteroid impacts that has cleared the way for new evolutionary growth. The future of redhousing will include man-made catastrophes to severely purge prematurely stabilizing indoor ecosystems and clear the way for new rounds of the game of survival of the most (man-determined) fittest.

Redhousing and the Plan for Mars

As progress allows us to preview the eventual results, we will know better what areas of Mars to set aside as future areozoic parks and preserves. Low-elevation basins and canyons will have the highest atmospheric pressure, the warmest temperatures (latitude for latitude) and be the first to experience dews and eventually free standing and/or flowing open water. The Mars Orbital Laser Altimeter aboard the Mars Global Surveyor (November '96 launch, September '97 arrival) will give us a good idea of where these oases-to-be are located. We will then even be able to speculate about setting aside right-of-ways for future parkways.

Redhousing in the Grand Design of Things

To return to the point we made at the outset, if Mars is devoid of life, that makes it a virgin world, not a barren one. The cosmic vocation of humanity, unsuspected by all the world's pretentious scriptural traditions, may indeed be to bring life to places where it can survive, but never originate on its own. Only an intelligent species can serve this function. Humanity then becomes "the" reproductive organ of Gaia (meant as the name of Earth-Life in aggregate, not as some mythic meta-individual).

Further, through interstellar flight, even if it only be of ships bearing nothing more than seeds, spores, and fertilized eggs, this particular human vocation takes on a more general Cosmic significance, *in the Solar neighborhood* (probe-reachable limits to be determined!) beyond this nursery womb-world nano-turf we call Earth. MMM

Make a Mars "Redhouse"
with controls, entry safeguards etc.,
as a chapter project
or school science project
for public display,
including ISDCs.

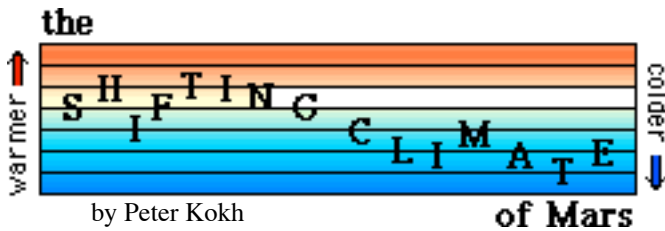

and the challenges for those who need data points for their terraforming schemes.

Those brave optimists who essay to put together various schemes to bring about major climactic and environmental changes on Mars in order to render the planet much more appealing a destination for would be Earth-forsaking homesteaders, can, at present, do little more than B.O.E. (“back of envelope”) calculations of the material and energy inputs and relocations needed to bring about such changes.

Whether the goal is “terraforming” (making the planet another “Earth”) or “Lowellification” (making the planet at least as friendly as we thought it was fifty years ago), or “rejuvenaissance” (“restoring” Mars to its wettest and warmest former state of about three billion years ago), the equations are hard to work without good data about the present.

In point of fact, despite all the revelations of the Mariner and Viking missions, we know much less about the Mars of today, than most writers will admit.

(1) We don’t know within two or even three orders of magnitude how much water remains on Mars, locked up in the polar caps, in subterranean aquifers and lakes, or chemically bound up in hydrates, or frozen in the interstices of soil particles as permafrost. Nor is such vital information the target of instruments aboard presently budgeted missions to Mars.

(2) We don’t know how much carbon dioxide is locked up in clathrate frosts at the poles, nor how much may be chemically bound up in sedimentary carbonate rocks or limestone layers.

(3) We have only a very crude idea of the relative altitudes of Martian surface features, and thus only a very imperfect idea of potential drainage basins and watersheds. Fortunately, this ignorance is being addressed by the **Mars Global Surveyor** ready for launch later this year.

(4) Hubble has shown that what we thought we “knew” of Martian temperature ranges, was pegged to a transitory condition.

Apparently, mean temperatures on Mars have dropped an astonishing 20° in the two decades since Vikings I and 2 established weather stations on the planet. By comparison, a mere 2° rise in terrestrial temperatures worldwide, would cause environmentalists and meteorologists and climatologists to reach for the panic button.

At the moment, we have no idea how long-lasting this cooling will be, nor even if the downward swing has bottomed out, nor on what time frame such meta-seasonal changes take place. Given that, brainstorming pathways to a friendly future are interesting fantasies and no more. As they say, “garbage in, garbage out.” Yet carefully designed future missions could tackle each of these points of our ignorance quite well. **MMM**

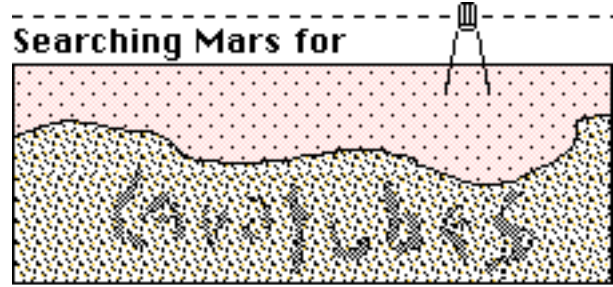

Mars’ vast shield volcanoes & lava sheets are prime territory for lurking lavatubes & prime real estate for the New Martians

by Peter Kokh

Whatever geological and scenic attractions may beckon siren-like to the first manned Mars expeditions, the “california” of future waves of Martian homesteaders is more likely to be the expectedly lavatube riddled shield volcano flanks of Olympus, Arsia, Pavonis, Ascraeus, and Elysium - and likely similarly endowed vast lava sheets of the attendant Tharsis uplift region.

The pre-excavated radiation shelter and the thermally buffered retreat of the tubes will make any settlement establishment much easier, giving it a considerable head start, as well as an enduring advantage. Mineralogical assets will also count, of course. And happily, the Tharsis region impinges on the head of the great Valles Marineris canyonland complex where many strata of rock will lay revealed for prospecting ease. **Pavonis Mons**, a great shield volcano already cited as possibly the most strategic mountain massif in the entire Solar System, its western flank the ideal site for a launch track complex, neighbors this canyonland head region on its eastern flank. [Cf. MMM # 18 SEP ‘87, pp. 6-7 - MMM Classics #2]

But all this is little more than reasoned speculation. We do know what kind of terrain sports lavatubes on Earth and we do see analogous terrain on Mars. But that’s it. On the Moon we have the added advantage of seeing actual examples of partially and wholly collapsed lavatubes (e.g. Hyginus and Hadley Rilles, respectively). Surveying such features on the ground will take generations. If we can search for them with orbiting instruments, our pre-settlement “treasure” maps of Mars will be enormously more helpful and propitious.

While many, if not most tubes may lie within lava sheet layers that have been subsequently buried by later flows and thus be well below the surface, those in the uppermost flows should lie near enough to the surface to be detectable by appropriately tuned radar.

Cf. MMM # 44 APR ‘91, p. 6, in which we report on the suggestion of Tom Billings of Oregon Moonbase (and published in Oregon L5’s **Starseed**) that since airborne radar had been used successfully to find lavatubes on the Big Island of Hawaii [i.e. the Mauna Loa / Mauna Kea shield volcano complex], given the dryness of the lunar [and Martian?] surface, it should be possible to map near surface tubes with orbiting radar. To penetrate deeply enough we would need a wavelength of 5-20 meters, meaning an antenna 20-80 meters across.

Given our experience with the quixotic results of some of the Viking lander experiments, it only makes sense to

fly such instruments first in low Earth orbit. We can then compare the findings with known “ground truth” and check the verisimilitude of the readings and better correct the calibration. Finding unsuspected tubes in various regions on Earth may be reward enough to merit such a precursor mission.

This being done, a second such orbiter mission could do its tricks in orbit above the Moon, adding enormously to the practical knowledge necessary for intelligent planning of lunar development scenarios. The third tubefinder mission would head for Mars polar orbit. Lessons learned at Earth and at the Moon would allow mission planners to fly the leanest and lightest and least expensive probe to Mars capable of doing the job usefully well.

Would permafrost deposits interfere with the readings and conclusions. Not likely, as the radar wavelengths for the former are LONGER - SHORTER by a factor of X. However the radar instrumentation needed for the two global searches would seem to make made-in-heaven bus mates — a “tundra and tube” mapper. If we did find permafrost and tubes in the same region,. and we may not, that would mark the location as especially attractive for settlement development.

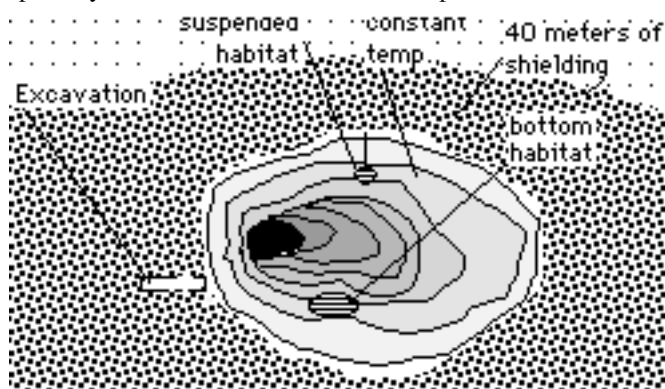

LAVATUBES AND THEIR USES: On Earth, these features are typically a few tens of meters wide and high and hundreds to a few thousands of meters long. On the much less gravid Moon, and with the scale of Hadley Rille as evidence, we expect to find lavatubes hundreds of meters wide, and many tens of kilometers long. On Mars, with its in between 3/8ths normal gravity, we might expect such features to be in between in size, say 50- 100 meters wide and a few kilometers long. On both the Moon and Mars, “tubing” will be a major outdoor hobby, akin to limestone cave spelunking on Earth. **MMM**

CHRISTEN THESE TWO PROPOSED MISSIONS:

MMM invites readers to propose (a) name(s) for our proposed **Mars Permafrost Orbital Mapper** and **Mars Lavatube Orbital Mapper**. The name can be drawn from mythology, literature, or history, or consist of an appropriate acronym.

This not an idle exercise. Chapter space activists were responsible for christening “Lunar Prospector” in ‘89, a name which stuck through several deaths and rebirths.

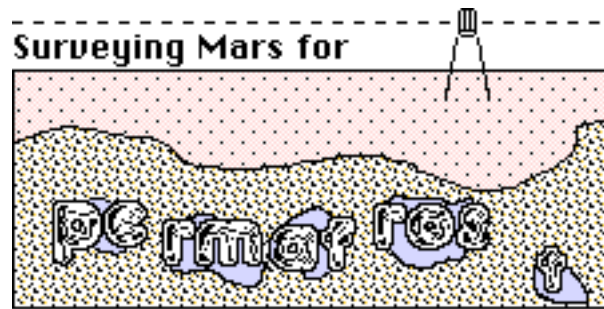

by Peter Kokh

PER·ma·frost: [from perma(nent) + frost] perennially frozen subsoil. Also called *pergelisol*.

Where do we find permafrost (on Earth)?

We find permafrost mostly in circum arctic lands of Alaska, Canada (Northwest Territories, northern Quebec, northern Labrador), Greenland, Iceland, Scandinavia (Norway, especially), and Russia-Siberia. Permafrost is the soil condition that manifests itself in “tundra” type no-root or shallow-root vegetation.

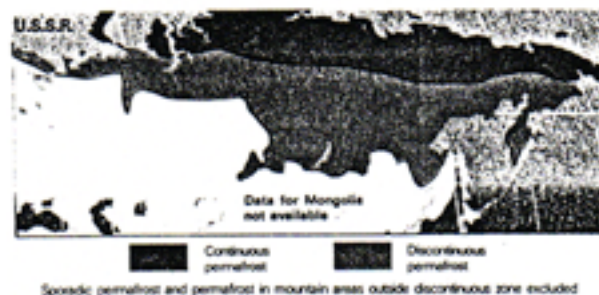
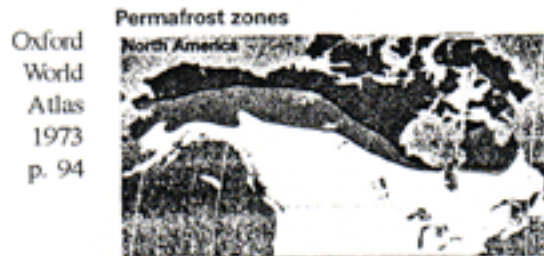

[*loc. cit.*: Permafrost can be differentiated into 3 main zones: (a) continuous permafrost, where very little land is unfrozen and where permafrost may reach depths over 600 meters or 2,000 feet; (b) discontinuous permafrost, where patches of unfrozen ground occur; and (c) sporadic permafrost, where patches of permafrost occur in a generally unfrozen area. Overlying the permafrost is an ‘active’ layer of rock or soil which thaws in summer and freezes in winter.]

How does permafrost form?

Permafrost forms in ground water areas through gradual transition to ever more severe winters and ever shorter and cooler summers. The deeper the ground water penetrates, and the greater the water content per volume of soil, the thicker and richer the permafrost layer.

Why do we think there may be extensive permafrost deposits on Mars?

There is abundant evidence from high resolution Viking photos of landforms for which the only plausible explanation is that they were formed by water: tear drop shaped islands in the middle of large valleys, relic beaches and ancient

shorelines, wave-sculpted dry lake and sea shore bottoms, deltas and estuaries, flood-carved channels. From such evidence, it has become clear that Mars even sported a respectable northern hemisphere ocean that once covered more than a third of the planet to respectable depths. Not all of this water could have evaporated or sublimated into space. Archaic water-saturated lake and sea bottoms should have retained their water content as the climate got colder and the ground froze to deeper and deeper levels.

Where on Mars is permafrost most likely to be found?

The likeliest areas of significant permafrost deposits are the ancient northern ocean bottomlands, deep major impact basin bottoms like Hellas and Argyre, and canyon bottoms (especially the outflow areas like the Ares Valley landing site for the **Mars Pathfinder** lander. Unfortunately, this lander is not providentially equipped to test for permafrost underfoot. It is typical that the kind of knowledge most needed to assess settlement feasibilities is low on the priority list of planetary scientists interested primarily in scratching the itches of their own narrow scientific curiosities. Both Vikings likewise landed in areas in which we might expect to find substantial permafrost deposits, a condition that went untested.)

Permafrost could have formed in adjacent areas not covered by standing water through the lateral spread of ground water, and in still other areas if subject to seasonal rainfall.

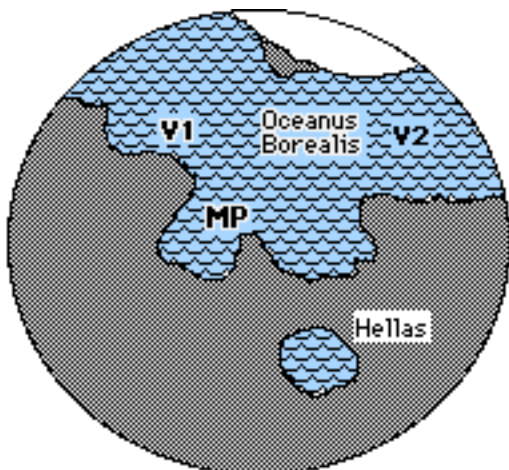

What, if any, would be the significance of permafrost on Mars for future settlement / development?

On Earth, (a) permafrost renders the land agriculturally unproductive, although tundra lichens and other vegetation is sufficient to maintain a large wildlife population of caribou, rabbits, and other hardy arctic fauna. (b) Buildings must be set on bedrock or thermally isolated from the ground, commonly by use of stilts made of materials with low heat conductivity, along with effective use of insulation to prevent heat radiating from the bottom of the building to the frozen soil below. The stilts should raise the underside of the building high enough above the ground to allow free air and wind circulation. (c) Road building creates special problems: special measures had to be taken during the construction of the Alaska Pipeline.

On Mars, seasonal thaws may not be a problem at first, but may become less and less rare as human activities, planned and unplanned, lead to a significant warming of the Martian climate. (a) For this reason, outposts in permafrost

areas will be especially challenging to build and maintain. Settlement may be limited to areas of patchy permafrost, with construction held to frigid *but not ice-saturated* soil and rock areas. (b) Only those areas where the 'topsoil' is 'active', i.e. thawing seasonally, will be colonizable by bioengineered Mars-hardy plant varieties developed through an aggressive redhousing program.

Mars outpost on stilts- insulated

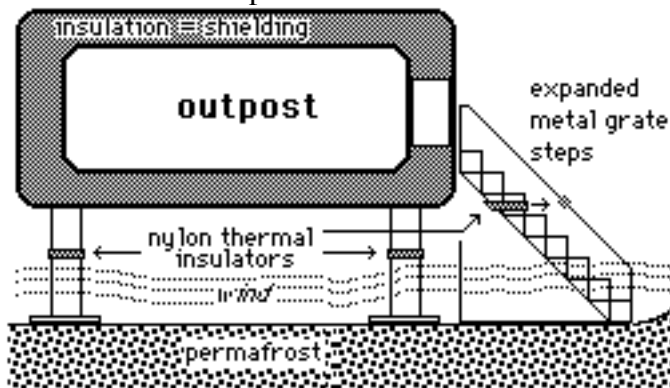

Mars subsurface outpost - insulated

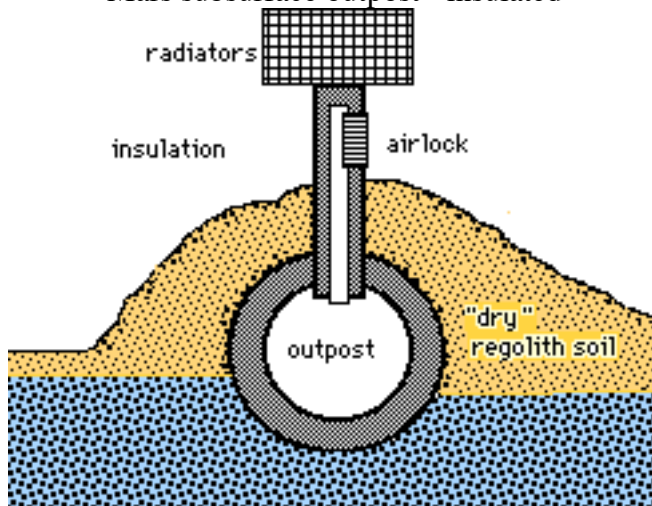

Mars subsurface outpost in "patchy" area



How can we tap permafrost water assets?

(1) We *could* strip mine the permafrost layers and then run them through melting ovens on conveyors, redepositing the dried soil back in place, all in one operation. This could be more mechanically difficult than it sounds, with lots of equipment breakdowns, given the hardness of the soil/ice aggregate.

(2) We could heat the deposits in situ (in place) and then pumping out the freed and liquefied water if excess waste heat at a high enough temperature is available. This requires

drilling holes for heat conducting rods or superheated steam pipes. Such waste heat would be available if the outpost had a small nuclear plant both for heat, power and for extraction of various atmospheric gasses.

(3) We can cover the frozen ground with an “infrared-black” plastic tarp and apply concentrated solar heating.

Which ever method we use to extract the ice-melt, it may be necessary, if the water proves to be saline, to distill the melt to purify it of salts (and possibly heavy metals). A few “ground truth” cores taken by rover drilling probes would soon establish just how fresh or how brackish the permafrost ice is, and whether it varies in quality from place to place.

Excess water produced by an outpost’s local permafrost tap may then be trucked, or airlifted, or eventually pipelined to other less advantaged settlements and outposts. Thus, water could well be the first real intra-Mars trade commodity. (A futures market, anyone?)

What alternative sources of water are there?

Other most options for providing water needed for drinking and hygiene, agriculture and life support, processing and manufacturing do exist:

(1) Nuclear powered atmospheric hydro-extraction plants are certainly feasible. In 10,000 tons of Mars air, there are 3 tons of water vapor, i.e. 0.03%, plus 7 tons of oxygen and 270 tons of nitrogen, both of which would also be extracted as byproducts. Each outpost or settlement is likely to have such a plant anyway, to produce carbon monoxide and methane fuels as well as fresh oxygen and nitrogen. The question is, will such a plant produce enough water in the process to meet demands, or will this “air-water” need to be supplemented?

(2) A much bolder and higher cost option would be to mine ice from the edge of the north polar cap (the southern cap may be mostly carbon dioxide frost). Melted, this glacial melt could then be trucked (requiring roads or ground effect vehicles) or (especially later as population on Mars and demand grows) a network of aqueducts would follow the paths imagined by Schiaparelli and Lowell from the north polar cap southwards. (cf. MMM #62 FEB ‘93, pp. 6-7 “CANALS on Mars” [republished in MMM Classics #7] and MMM #73 MAR ‘94, p. 5 “Canal Names” - Read in MMM Classics #8) One or both of these options can serve “ice-dry” areas of Mars.

Putting together a Mars Permafrost Map - Now

Because extensive permafrost zones are found here on Earth (some continuous, some discontinuous, some patchy), we have an ideal opportunity to fly the needed radar instrument package in polar Earth orbit to both test how well it can detect permafrost and to properly calibrate the instruments by checking their readings with actual data on the ground, so we will have greater confidence in interpreting the readings we get in flying an identical instrument package around Mars. We need to determine how well depth of the layer below the surface, ice content percentage, and thickness of the deposits are indicated in the readings, and whether differences in salinity or other factors affect the data points we get.

If flown alone (not with lavatube radar) as co-op U.S.-Russian mission, **Bering** (Russian-born explorer of Alaska, Vitus Bering) might be a good name for the probe. **Mars Permafrost Mapper** would be an alternate choice. 



A Space Frontier Tech Demo Program IDEAS for Lo-budget, 2 yr.-feasible demonstrations of technology items that will be needed or useful on the Martian Frontier.

[* The following suggestions by no means exhaust the possibilities and readers are encouraged to think of, pre- brainstorm, and report to MMM of other neat doable projects that will help bring home to all of us, veteran space enthusiasts and general public alike, the concrete doability of space pioneering on the Moon, Mars and elsewhere in the Inner Solar System.]

The “Mars Engine”

The goal is to produce a motor vehicle engine for use on Mars that will burn fuel and oxidizer derived from Mars’ atmosphere and whose combustion products will return to the atmospheric gasses from which they were derived. Two fuel combinations are possible: “**Carmonox**” engines will burn carbon monoxide (2 CO +O₂); “**Methanox**” or “**Oochie™**” engines will burn methane (O₂ + CH₄). Methane is the more powerful fuel and will be the fuel of choice if reasonably salt-free water can easily be produced from permafrost taps.

The GOAL of this tech demo is not a vehicle chassis suitable for Martian terrain, but an engine that can be used in any such vehicle: car, truck, coach, caterpillar, etc.

START: There are *now* any number of experimental methane burning vehicles already on the road. REPLACE the carburetor with bottled oxygen and combine with the methane in an INTERNAL COMBUSTION cycle, not a rocket motor.

AND DEBUG. DEMO at ISDC ‘98 Milwaukee.

A Mars Airplane

The density of Martian air at average surface levels is equivalent to the atmospheric pressure on Earth at 125,000 ft., an altitude that can be reached by a balloon-mounted platform. DESIGN, BUILD, and FLY an unpiloted airplane to and from such a platform - at or during ISDC ‘98 Milwaukee.

Paul Swift of the Ontario Space Society (ISDC ‘94 Toronto) has expressed an interest in taking up this challenge.

Mars Meteorburst Experiment

Meteorburst communications which bounce messages off the electronic debris trails of incoming meteors high in the atmosphere have been used successfully for over-the-horizon communications by long distance trucking companies. The devices never having to wait more than a second or two before finding a suitable placed meteorburst.

Because these events occur high up, this system also should work well on Mars, as a reliable backup to a more expensive to deploy and maintain satellite communications system. DESIGN, BUILD, and FLY such a system, again aboard a balloon-hung platform at an altitude of 125,000 feet.

💡 T D Igloo shielding sebatier reactor

Can shielding be manufactured by a sebatier reactor from atmospheric components on Mars? If so, a small nuclear thermal power plant could enshield a telerobotically landed Mars habitat module or complex without disturbing the boulder strewn and possibly permafrost hardened soil all around the campsite to be.

One possibility, in theory, is DiNitrogen Pentoxide, N_2O_5 , which is a white powder throughout the whole range of Martian ambient temperatures. It is dangerously chemically unstable, however. A much safer product would be simple carbon (graphite) dust, powder, or crystals.

DESIGN, BUILD, and DEBUG a sebatier reactor device to start with a Mars-like atmospheric mix and end up with such an inert thermal shielding powder. Make note of any potentially useful atmospheric byproducts produced in the process. DEMO at ISDC '98 Milwaukee.

💡 T D Mars Hovercraft or Skimmer

Traversing Mars boulder-cluttered strewn-fields will be slow going and impede easy, frequent, and timely travel between outpost sites on Mars by wheeled vehicles or legged walkers. A hovercraft which could skim over such routine obstacles at speed would open up the planet like nothing else could. Mars' low atmospheric density, however, makes a traditionally designed hovercraft infeasible. If the weight of such a vehicle, with cargo and fuel, could be partially (say 90%?) compensated by hydrogen aerodynamically styled buoyancy bags, perhaps such vehicles could work. Hydrogen is safe to handle on Mars where there is no free oxygen to speak of.

DESIGN, BUILD, TEST, and DEBUG a scale model Mars Skimmer. DEMO at ISDC '98 Milwaukee.

💡 T D A Mars "Redhouse"

Unlike a "greenhouse" which maintains terrestrial plants under Earth-normal ideal growing conditions in less than ideal climates, a "redhouse" would be pressurized with relatively pure Carbon Dioxide, CO_2 . BEGIN with the hardiest plants known on Earth, lichens and other tundra plants; plants that thrive in the high altiplano of the Andes, and at the tree line of other high altitude areas; plants that thrive in desert conditions; plants which survive intense cold.

The eventual goal of "redhousing" will be to breed ever harder and harder hybrids which someday may take hold and survive outdoors on a Mars where human intervention has succeeded in meeting them halfway by raising the carbon dioxide atmospheric pressure and ambient temperatures.

For ISDC '98 Milwaukee, the goal is simply to DEMO a redhouse chamber with controls capable of varying the pressure and temperature.

HOW TO PROCEED:

The game plan:

- Gather a team with the right mix of expertise,
- brainstorm a design
- price the materials and tools that you will need
- make a presentation to potential corporate sponsors

Mail Box

✉ **Is Mars more impact prone than Moon?** It would seem to me, that settlers on

Mars could be more exposed to meteorite bombardment than pioneers on the Moon. Mars weighs in some 5 times heavier than the Moon, giving it more gravity [3/8ths vs. 1/6th Earth-standard] and hence a bigger/wider/ deeper gravity well. This means it will "catch" more asteroidal and cometary debris, and impose on it higher velocities of acceleration prior to impact.

Mars tenuous atmosphere will burn up the micrometeorite stuff, so that Mars' surface is not subject to the steady 'rain' that the lunar surface undergoes. It would follow that the dust on Mars is from weathering, rather than impact "gardening". But the larger stuff will not be stopped and much will get through that incinerates in Earth's much thicker atmosphere.

Further, Mars is much closer to the main asteroid belt and probably is exposed to a thicker concentration of debris than the Earth-Moon system.

We should not be misled by visual and photographic comparisons of the Martian and Lunar surfaces at various resolutions. Unlike the Moon, Mars experiences real weather (wind, and scattered freeze-thaw cycles) and formerly underwent major episodes of volcanic activity. This gives its surface a deceptively younger, less impact-scarred look.

Not to scare anyone away. The heavy lunar bombardment we see happened mostly more than 3 eons [3 billion years] ago, and danger to pioneers will be less than us terrestrials face in volcanic eruptions, earthquakes, hurricanes, tornadoes, lightning, avalanches, landslides and other catastrophes from Earth's active geology and weather systems. The same should be true on Mars.

Thomas Heidel
Milwaukee, Wisconsin

EDITOR: Thanks Tom. You have summed up the situation accurately.



Neil Durst cartoon

MOON ZOOM

Starting your backyard/armchair tour:

Mare Crisium, the Sea of Crises

by Thomas Heidel, LRS - an MMM-Pleiades exclusive

Asked to do a series on backyard telescope observing of the Moon, the first decision I made was to bring along all of you who do not (yet) have (access to) a telescope or even a pair of binoculars. All armchair amateurs will need for our "Settlers' Viewpoint Tour" is a decent map of the Moon's near side, and/or a photographic atlas of the Moon.

Next I decided to start with the easiest feature on the Moon to pick out with the naked eye, a circular mare or gray lava plain that stands alone from the "chain" of interflowing maria that dominates nearside, and which is easily picked out by the naked eye from first crescent (morning shadows) up to four days after full Moon (evening shadows at Crisium). More billions of people have noticed Crisium (without knowing its name) than any other feature. At 10-17° N, 50-70° E, it is the right eye of the "man in the moon". Imagine the Moon's E-W path through the night sky. Tilt your head perpendicular to it, and Crisium is in the upper right quadrant. Through an image-inverting telescope (not binoculars), find it to the lower left.



Crisium at (a) local morning, (b) local noon, (c) local evening
 (a) '96: 3/22, 4/20, 5/20, 6/19, 7/18, 8/17, 9/15, 10/15, 11/14
 (b) '96: 3/28, 4/26, 5/26, 6/25, 7/24, 8/24, 9/21, 10/21, 11/20 (c)
 '96: 4/6, 5/5, 6/3, 7/2, 8/1, 8/30, 9/28, 10/28, 11/27.

Along with other major nearside seas, it's name first appears in Riccoli's 1651 chart of the Moon. 260 miles N-S and 370 E-W, its 66,000 sq. mi. compares to Wisconsin plus Michigan's Upper Peninsula. It has some easy-to-see features.

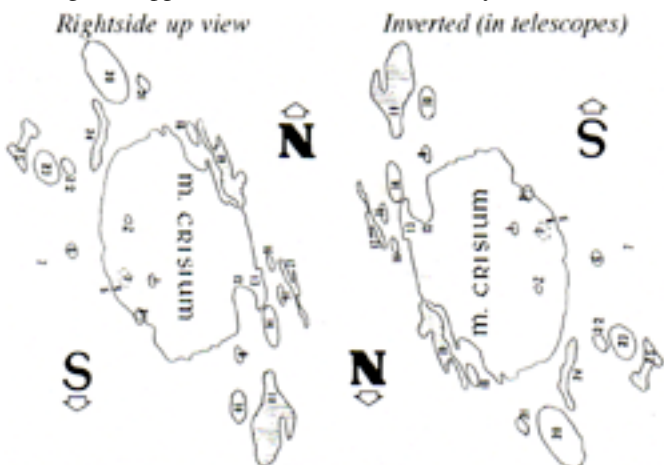

Out on the mare the crater [1]Picard (Jean, not Jean-

Luc) with a small central hill is easy to find. To the north of it find smaller [2]Pierce. Look from Picard towards the near western shore and pick out the incomplete rim of the larger but lava-sheet flooded crater [3]Yerkes. Kokh [1] has suggested a new nomenclature for crater rim remnants poking through the mare fill: *saxa* (Latin for reefs). Between *Saxa Yerkes* and the mare coast look for a long flat gray area. In [1] "Expanding Lunar Nomenclature", in *Selenology*: (American Lunar Soc. quarterly, issue # unavailable at press time) Peter Kokh has suggested another feature category be adopted: *fretum* (Latin: straight). Keeping within the meaning orbit of "crisis", he suggests [4]*Fretum Hodiernum* (Straight of Today) for this area. Past it a ways into the bordering highlands ([5]*Ora Vigilium*, Coast of Sentries) is one of the brightest lunar craters, [6]Proclus, often changing its appearance to careful observers, suggestive of "transient lunar phenomena". Beacon bright, it is a very easy feature to pick out. Beyond Proclus, on the fringe of Mare Tranquilitatis, lies [7]Palus Somni, Marsh of Sleep.

Moving counterclockwise past [8]Lick, and again a short distance into the border highlands along the south, find the crater [9]Auzouit, and south of it the larger dark floored crater [10]Firmicus, and past it, a small irregular dark plain called [11]Mare Undarum, the Sea of Waves. Now look for cape [12]Agrarum on Crisium's SE coast. Beyond it lies an unnamed bay (Kokh: [13]*Sinus Constantiae*, Bay of Constancy). To the ESE find the large flat-floored crater [14]Condorcet. East of Crisium lie [15]Hansen and [16]Alhazen, and beyond another irregular unnamed mare-filled area (Kokh: [17] *Lacus Spei*, Lake of Hope).

Just past Crisium's NE coast, beyond the crater [18]Eimmart, find another irregular mare-flooded valley known as [19]Mare Anguis, Serpent Sea. From its shores, Earth is a comfortable picture postcard distance above the WSW horizon. Redubbing the valley "Angus Bay", Gregory Bennett, chief architect of the Artemis Project™ suggests this site for a first commercial Moonbase. Precisely because Crisium is so easy to pick out with the naked eye, from a publicity/public awareness point of view alone, Crisium seems prime turf for a first outpost. Its coasts and shores offer access to Al-rich highland and Fe/Ti-rich mare soils alike. Kokh's favored site is *Fretum Hodiernum*, across the mare, handier to the rest of nearside.

Directly north of Crisium is the dark flat-floored crater [20]Cleomedes, very easy to pick out in binoculars, and the crater [21]Delmotte to the east, back towards Mare Anguis.

To the WNW of Crisium find [22]Tisserand, and just beyond it the larger [23]Macrobius. Between Tisserand and Crisium, and north of Macrobius are two irregular unnamed mare-flooded valleys. (Kokh: [24]*Lacus Parationis*, Lake of Readiness; and [25]*Lacus Vigilantiae*, Lake of Vigilance.)

Back to Crisium itself. Notice the subtle differences in shading out on the mare floor, indicating the exposed areas of distinct episodes of lava-sheet flooding, each with slight (advantageous?) differences in regolith-soil composition.

Revisit Crisium frequently at different phases and local lighting conditions. Learn to recognize the features mentioned above. Appreciate the differences between individual features. *Make yourself at home!* TH

The Cultural Implications of the Moon's 1/6th G



This month, we return to our essay series on the early days of a permanent human community on the Moon, as we at the **“Lunar Condition”**, the defining set of parameters that go with the territory

and will leave an indelible mark on early Lunan culture and civilization. *The Moon is a world dramatically different from Earth.* One way this was brought home to hundreds of millions was the sight of our astronauts and their moon buggies bounding and bouncing about in the lower gravity. The effects of “sixthweight” will be more than anecdotal. For the impact of the Moon’s environment on pioneers, see *below*.

IN FOCUS  **“Alien Shores” – We’ve been this way before!**

In this issue, we take a look at the “environment” of the Moon in so far as it will deeply affect the paths taken by future development, settlement, and outgrowth of a uniquely Lunan culture. It is a global setting that seems utterly barren, sterile, and hostile — in a word “alien” to everything we consider within the widest range of suitability, within the collective limits of human experience.

Indeed, is this not the popular objection to off-Earth colonization we hear most frequently and spontaneously expressed? “These are alien and hostile places, where we clearly do not belong! We should stay on our home planet!”

But Earth, globally speaking, was not always home. Our progenitors, according to current consensus, evolved on the East African savannas. If so, we are native to a relatively small subset of what is a very great range of diverse terrestrial habitats and climates. Once upon that time, much of the rest of Earth was effectively as “alien and hostile” to these early men as the Moon and Mars are now.

Out of this relatively narrow and specialized homeland, we have spread to rain forest and jungle and swamp and desert and mountain fastness and coasts. In each case, we left behind things with which we were comfortable dealing, and faced new material, climatic, plant and animal resources and challenges that we could only learn to use by trial and error.

Yes, we’ve been through this before, collectively as a species, time and time again. In each case, what was once totally “alien” to all our previous experience became absorbed. We learned how to cope. Dangers and risks were tamed with “second nature” habits and new local common wisdoms that dealt with them effectively.

We learned to clothe ourselves, not once, but many times in ever more resourceful ways. The same holds true with

our need to provide shelter. And, of course, food. It is this difference in the set of challenges facing different peoples in diverse new habitats that is the wellspring of different non-hereditary cultures. It is too this failure to flinch before the apparently “alien and hostile” that may have prioritized the development of language, by which “show” became “show and tell”, a much more capable tool of tutelage.

Think for a moment of how “worlds apart” are those early East African grasslands and the Siberian Taiga, the Peruvian-Bolivian-Chilean altiplano, and the North Polar eskimo-lands. Was not the conquest of the latter by native peoples the “remember the Alamo” equivalent that we find ourselves called upon now to follow?

Was the challenge of endless shifting ice flows, of permafrost tundra slopes barren of all but lowly lichens, of severely cold seasonal temperatures, not just as relatively intimidating as the raw exposure we find on the Moon to cosmic rays, solar flares and ultraviolet, and the incessant micrometeorite rain, all in near vacuum among utterly sterile, barren, and water-virginal soils? No, we’ve been through all this before, collectively as man, time after time.

We could go back further. Pre-human life before us is the culmination of an eons long march out of the “First World”, the Sea. We ourselves must see our yearning for new worlds beyond orbit in this perspective. And then we must remind others (for have we not collectively forgotten?) that this is not a wholly new thing on which we would embark. It is but a pendulum swing back to a cyclic theme that has been part of life for four billion years. And, more than a cyclic theme! A cyclic imperative!

But here we must be very careful. For this is an imperative which has never been wide-felt. When conquest of the land became ripe, most life was more than content to remain in the Sea. It felt no such challenge. Similarly with the plant, animal, and eventually human conquest of one new terrestrial habitat after another. There never was an overall imperative. In every case, all but the few thrived contentedly enough where they had always been, within memory.

Colonization has never been the task of the most successfully adapted. Rather it has fallen always to what we might call “the second best” - those capable of resourcefulness but incapable of competing with the dominant sectors of their own populations. They had to either push out to new and by the old standards less favorable habitats, or remain downtrodden where they were, if not perish altogether.

No “whole” population, structured by government or not, has ever set out to transplant itself except in the case of total environmental and ecosystem collapse within its homeland (e.g. the Anasazi). Colonization has always been a rather disorganized and spontaneous activity of “second best” individuals. If you want a “Beatitude” especially appropriate for the space frontier, it is this: “Blessed are the second best”.

Yes, the Russian Empire set out to force-settle the Siberian steppes and Taiga (with what it considered the dregs of its own population). Yet these were not empty lands but areas already spontaneously settled by native peoples.

Yes the American and Australian governments deli-

berately undertook to settle their respective Wests. But in each case, in all honesty, the government but supported and facilitated a popular movement of resourceful frontier-minded individuals in an effort that would have collapsed without them.

Indeed, the only all-government effort to create a presence in a previously unoccupied land has resulted in no more than a caricature of settlement. We speak of course, of Antarctica, presently closed by treaty to pioneering individuals and their families. Despite the onus of this legal precedent, space activists, even anti-Moon Treaty diehards, have been asleep on the wheel, protesting not a whimper when the the Antarctic Treaty was renewed recently for another thirty years.

If, when all is said and done and written, humankind fails to establish secured footholds beyond Earth, it will be the fault not of governments, but of the collapse and disappearance of the resourceful frontier-minded pioneer spirit among individuals. No amount of unlikely government support can ever make up for such a vacuum.

“These are” by our all too frequent, all too whining complaints, “not the best of times”. But they are good enough to endure most of us into contentment with life on Earth, whether we’ll personally admit it to be good life or not. Many are those of us who want to see the space frontier open, but few there are of us who would personally venture out there. *Certainly not* while the frontier is full of rough edges and beset with growing pains. We’ll wait until things become science-fiction sophisticated, until the Kansas Cities of the Moon, Mars and free space are as genteel as the Baltimores of yore.

Yes sir, we’ve been this way before, to alien shores. But will we ever go again! I don’t know, but proceed as if we will, because I hope what has been in the “second best” of life from the outset, is still there. It all depends on whether those of us with the right stuff are collectively numerous enough to form a critical mass of talent, resources, and determination.

Meanwhile, all too many of us lay the task not at our own doorsteps but, let-George-do-it like, at the doorstep of our governments. That, my friends, is pathetically wasted time and energy. Government will *follow* where the people lead, *not vice versa*.

But I fear we may have *institutionalized* this mistaken stratagem. The moment we did so is ever so clear. It was in the vote that two-thirds of us chose as our name, “The National Space Society”, eloquent witness to our belief that opening the space frontier is properly government policy. The other choice offered, “The Space Frontier Society”, denotes instead a free association of people, undefined by national status, determined to open space “by any means possible”, including, but not limited to, government facilitation and critical support.

“Oh, you beat a dead horse!” I hope not. Because if the horse is dead, so is the dream! The name choice is now an eight year old *fait accompli*. But that will *never* make it wise. We have in so choosing set before ourselves our greatest obstacle, our own failure to take ultimate responsibility for the dream. Of such stuff are tragedies oft’ made. **PK**

Continuing a New MMM Series]

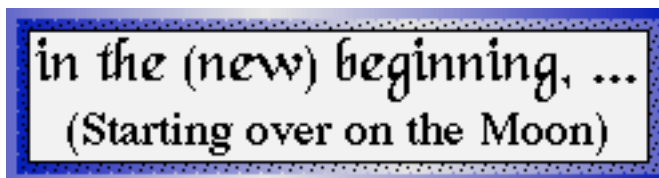

The primitive roots of “Lunan” Culture

This month we return to our series of essays on the very early lunar frontier. It may at first seem that a particularly “Lunan” culture will be a development a long time arriving. On Earth we are used to considerable cultural diversity, both from place to place and through the generations. It may seem outrageous to forecast the day when we will see revealed the considerable family resemblances all terrestrial cultures bear to one another. But there are certain time-and-place-transcending aspects of Earth that insert themselves in *every* human culture to date. For whatever the differences we love to exaggerate, we all share one very friendly planet, one encradling biosphere, the same gravity, the same protective envelope of sweetened air in which we work and play under wide open blue skies.

The unique equally transcendent wellsprings that will eventually make “Lunan” culture distinctive from *all* terrestrial cultures, making it in effect the first culture of a new family, will be present from the outset, intensely felt already by the first crew to take the plunge and “overnight” on the Moon.

The Moon is a world dramatically different from Earth. It’s gravity is only one-sixth “normal”. It is without atmosphere of any practical consequence. Its surface lies naked, exposed to the weather of space. It offers no life supporting biosphere of its own. These constraints will make life-as-we-are-used-to-living-it a memory-myth early left behind. As we deal with these facts and their consequences with a swim-or-sink urgency, and as we find successful ways to accommodate them, we will be forthwith face-slapped out of any romantic reveries we may have had. — *this month’s topics*.

So much for day one! Hardly will we have begun to cope and neutralize these brutalities and two other facts about the Moon will carve nascent Lunan culture even more deeply. The Moon is *very dry*. And its mineral assets lack some of the industrially strategic elements Earth’s more generous endowment has lulled us into taking for granted. — *next month*.

We have touched on each of these topics before in sundry articles. We do so again, all in one place, from the eye of the future historian and anthropologist interested in the very early beginnings of what is sure to develop into a uniquely Lunan culture and civilization.

There will, of course be many other things that add color to lunan culture. The sports that arise, for one thing: indoor, middoor, and outvac. Trade relationships and particulars with other off-Earth pockets of humanity throughout the Solar System. Political events. Art and Literature. The performing arts and media. And, of course, the indelible mark of powerful and influential personalities. But all these things will but add flesh to a cultural infrastructure grounded in the physical nature of our host adopted world, the Moon. And this infrastructure will fall into place almost immediately. **MMM**

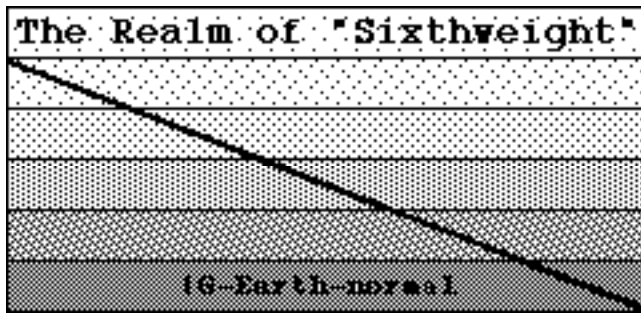

by Peter Kokh

Relevant Readings from Back Issues of MMM

[Republished in MMM Classics #1]

MMM # 8 SEP '87 "Colonists" I.Q. Quiz": Q. 1-3

[Republished in MMM Classics #4]

MMM # 31 DEC '89, pp 4-5 Prinztown Settlement Study;
"Hydroelectric System" - *illustrated*

[Republished in MMM Classics #5]

MMM # 47 JUL '91, p 5 "Native Born"

For the hundreds of millions who watched the first Apollo Moon landing, next to the black sky and the spacesuits the astronauts wore (eloquent joint testimony to the absence of appreciable atmosphere), the most visually striking thing we noticed is how our scouts bounded about the surface. Despite heavy backpacks that would have all but immobilized them on Earth, their gross weight was quite a bit lower than their muscles were used to handling. The surface gravity on this significantly smaller world is only one sixth that of Earth's.

Operating in "sixthweight" will make for more than an anecdotal, temporarily amusing difference. It will affect almost everything visiting crews and eventual pioneers do:

BIOLOGICAL EFFECTS

Bodily Functions - That the human body is adversely affected by long stays in low Earth orbit is well known. Blood circulation, digestion and excretion, muscle tone and muscle mass, heart rate, etc. all are affected. It seems as if our bodies were designed to operate with a gravitational "assist". After all, gravity is a transcendental parameter of our home world.

The medical evidence from zero-G ("micro-gravity" is the preferred physiologically irrelevant semantic micro-correction currently used to self-distinguish the 'in crowd') has led many to jump to the conclusion that nothing short of Earth-normal gravity will allow the body's several systems to perform satisfactorily. At least as far as gravitationally assisted blood circulation is concerned, they may be partially right. Gravity helps overcome friction within vessels and arteries, and the "mini"-gravity we will find on asteroids even as large as Ceres (1/30th Earth normal) may well be functionally zero.

It is an enormous and unsupported jump from that recognition to the faith-tenet of some that therefore long, term exposure to the one-sixth gravity of the Moon will also mean unacceptable physiological decline. One-sixth is infinitely larger than zero. No one, thanks to NASA's timidity when it comes to experimentation with artificial gravity, has been exposed to "sixthweight" for more than a few days - that hardly qualifies as a bona fide experiment!

Only long term exposure to sixthweight either on the Moon itself or in a rotating structure in space, will confirm the

more probable expectation that several physiological functions will decline but then plateau out at an acceptable level.

Cardiovascular health is not the only thing at stake. The *final* health seal of approval will require evidence from a fair sample of on-the-Moon pregnancies and subsequent fetal development, pediatric evidence from born-on-luna children and youth, the fertility rate of the first native born generation of adult men and women, and geriatric evidence from those living out the full term of their natural lives on the Moon.

Some would have us wait until the evidence is in before we commit to settlement. But that is preposterous, since we can only gather the evidence if we take the plunge, and the sooner we do it, the sooner we will know.

Physical Activities - the obvious things: walking, running, climbing steps, sitting, standing, and posture in general - even sleeping - and other bed-scene activities will be *translated* into the differently expressive tongue of sixthweight. Here is an area where we have no evidence at all. No one has ever walked on the Moon - not without a cumbersome space suit, except for a step or two inside the lunar modules, from which you can tell nothing. No one has tried to climb steps on the Moon under what would be normal conditions. No one has slept in a real bed on the Moon. There has been some pretty interesting speculation about sitting posture and about steps. We'll have to distinguish what comes natural to those coming from Earth and "just off the ship" versus, on the opposite end of the spectrum, those eventually born on the Moon.

Sports - gravity is less but momentum stays the same because it depends on body mass, not weight. You can be weightless but the only "massless" people are ghosts etc. Because traction and "purchasing power" will scale with the gravity level while momentum remains Earth-normal, it will be much harder to start, to accelerate, to maneuver, and to stop - this will apply to individuals and to vehicles alike.

It is interesting to speculate how we might make ourselves at home in such an environment. Will we kiss the traditional flat floored court and field goodbye in favor of banked sports fields? And/or will playing areas have cushioned side walls that we can throw ourselves against to help change the direction of our momentum? Will we use fellow players in both friendly and hostile bumping maneuvers, much as "jammers" do in roller derbies?

Dancing will also be affected. One can picture almost ethereal movements in Lunan ballet. But while dancers will experience considerably more air time (cellular phone users will be jealous), they too will have to accommodate the greater difficulty in starting, accelerating, maneuvering, and stopping. Perhaps both in ballet and modern dance and the night spot public dance floor, we will see a return to couples dancing in physical linkage, not just loosely opposite one another. This will allow partners to transfer momentum and direction to one another, as in the days of swing and ballroom dancing.

Exercise programs may well emphasize isometrics, in which one part of the body pushes against another. Some will want to maintain "earth tone" so they can more easily handle a return to Earth with its sixfold greater gravity (we think few acclimatized or native born Lunans will seriously entertain the possibility of gladly weighing six times more - that's too big a

jump). They will want to exercise in centrifuge gyms.

Children's gym sets will likewise show interesting characteristic differences from those on Earth. The kids will pioneer a characteristically different lunar-style gymnastics.

Transgenerational Effects - If you will, a couple of definitions. A genotype is the shape a living creature assumes as it matures from egg or seed insofar as it is determined by its genes. A phenotype is the shape it assumes insofar as it is determined by the environment. Take twin tree seeds, plant one in its normal habitat, the other up near the tree line on a mountainslope, and you would never guess that they belonged to the same species. Native born Lunans may look like a different race from their parents. On average, they might grow significantly taller and more lithe, and generally leptomorphic. Add in a couple of generations and they may not fit well in the habitats built by their earth-born ancestors. They will walk differently, sit differently, climb steps differently, dance different, play differently. These differences may dwarf those experienced in this country and elsewhere in the average height and weight of adults - coming from better modern nutrition.

Farming and Gardening - agricultural and horticultural implications of sixthweight include especially those gravity-assisted processes like hydroponic and other drip irrigation and nutrient delivery systems - requiring some minor and perhaps some major modifications, as well as soil and plant bed drainage. If the soil is too fine, a bed that may have drained fine on Earth could become water-logged on the Moon.

Will plants grow taller? Will they boast larger blooms and fruit? Or spindlier stems? Will these differences be subtle or striking? Science fiction writers have speculated about flower gardens of forest proportions in lunar greenhouses. Will we have a settling out into garden floor and garden "canopy" flowering species? Will such gardens be a major must see on tourist itineraries, and host many a wedding portrait session?

More important are the implications of phenotype change for food production and harvesting methods. Conveyors and chutes and other gravity-assist produce-moving equipment may need subtle changes. Again, the sooner we get our feet wet, even if its just in artificial sixthweight, the better.

Food Preparation - some cooking methods (boiling, at least), and the mixing and blending and separation by density of ingredients will surely be affected by transposition to the lunar gravity environment. Vinegar and oil, for example, will not be so quick to separate.

NON-BIOLOGICAL EFFECTS

Tool Use - Most of us are familiar with the major redesign of hand tools meant to be used in orbit that has been necessary to accommodate to weightlessness. The lack of gravity-assisted purchasing power, combined with the equal reaction laws of nature requires anti-torque compensation and other major changes. On the Moon, we will have gravity-assist to enable us to lean into our tools, but it will be less than that we are used to on Earth. Some of the modifications meant for tools used in orbit and outside space vehicle repairs may survive in some form on tools designed for lunar use. However, many tools unmodified from their common terrestrial form should do well enough for general use.

Operation of Machinery - Material handling equipment systems that rely on gravity assist may need some modification. This will be true both for solids and liquids. Some pieces of equipment, especially mobile units, may need to be redesigned for a lower center of gravity as on the Moon, tip-overs will be much more common, if compensation is not made. mass distribution

Vehicles - What applies to people, applies in exaggerated form to vehicles. It'll be harder to start, accelerate, maneuver, and stop on the Moon - simply because traction is reduced along with gravity, while momentum is not. Personal vehicles from indoor bikes to outdoor trikes to jeep equivalents, transport vehicles like trucks and coaches, "lith-moving" (road building and surface mining and gas scavenging) and construction vehicles, and sport vehicles will all need to be radically designed for sixthweight. At stake is stability in turning and banking, and overall safety.

As the years go by and native born Lunans start taking over, vehicle cabins may need appreciable redesign or resizing to accommodate their possibly taller average stature.

Furniture Design - because of both reduced weight and lower friction, furniture pieces will be a lot easy to move unintentionally by just bumping into or grazing them, an easy thing for non-adepts "fresh off the ship" yet to find their "moon legs". Thus furniture too may be built bottom heavy. Sofas and chairs may need a lot less cushioning, relying more on contoured seat areas - a good thing, because upholstery fiber would be an expensive item. We can expect more built-in furniture, not just cabinetry, but also bench seating, even beds - all for the reasons above. Provision for foot traffic aisles and walk ways may be more generous to accommodate a higher incidence of at least temporary clumsiness. Standard counter and table heights may also grow to suit taller Lunans.

Product Design - Bottom heavy design may extend to glassware, bottles, mugs, vases and other objects. Here we are ready to go with an ample suite of such things already designed for boat and recreational vehicle use.

Architectural Standards - Over time, as Lunans grow naturally taller, ceiling heights and door clearance heights will grow. Lunar habitat ceilings may be see a return to 9 ft. and 7.5 ft standards formerly common. Some expect "bounding ramps to replace stairs. But we will always need to accommodate the aging, the infirm, and those just off the ship. Paradoxically, it may be the latter, with their Earth-tuned musculature, who'll opt for bounding platforms. Those long acclimatized to sixth weight may need traditional stair sets.

Construction Methods - The lower gravity will allow easier lifting, and the suspension of more massive loads from ceilings and walls. There will be other subtle changes.

Power Generation and Storage - strange as it may seem, hydroelectric nightspan power in closed loop recycling water reservoir systems is a distinct possibility on this ultra-dry world. Water reserves could be pumped up crater walls and mountainslopes by solar power during dayspan, UV-sterilized under quartz panes, and then allowed to fall through generators during nightspan. Head heights will more than compensate for the reduced gravity. 



Exposed to the Weather of Raw Space

by Peter Kokh

Relevant Readings from Back Issues of MMM

MMM # 5 MAY '87 "Weather" [MMM Classics #1]

MMM # 37 JUL '90, pp. 4-5 "Ramadas"; "Flare Sheds";
"Solar Fringe Benefits" [MMM Classics #4]

MMM # 56 JUN '92, p 5 "Naming the Seas of Space"
[MMM Classics #6]

Earth and the Moon orbit the Sun together in shared space. Yet their respective surfaces have very different exposures to the elements of cosmic weather. Earth's Van Allen belts and strong magnetic field intercept a major portion of incoming solar flare particles - most of what does get in ends harmlessly in the beautiful displays of the aurora borealis (north) and aurora australis (south). Earth's deeper and wider gravity well attracts the lion's share of the meteoritic material coming our way, yet so much of it burns up harmlessly in the atmosphere leaving a gentle and imperceptible ash dew that the Moon seems unfairly bombarded in comparison. Finally, the oxygen turned ozone in Earth's upper atmosphere filters out the worst of the incoming solar ultraviolet rays. And salted with water vapor and carbon dioxide, the atmosphere serves as an insulator, raising Earth's surface temperatures some 50 °F (28 °C) over the Moon's average surface readings, and helps greatly moderate the swing between extreme highs and lows.

Bereft of both magnetic field and atmosphere, the Moon's surface lies naked, exposed to this many-faceted electromagnetic onslaught. One cannot even compare conditions here with those in low Earth orbit, a realm within the wave-breaking "harbor" wall of Earth's Van Allen belts.

Proper [rego]lith-shielded habitats, however, offer protection not dissimilar to that of Earth's atmosphere. Both involve blankets. Earth's is gaseous, mostly nitrogen and oxygen. The Moon's blanket is the regolith, the impact-pulverized layer of inorganic 'topsoil' that covers everything to a depth of 2 - 5 meters (~ yards, i.e. 6 - 16 ft.). Pioneers can either find the alternative shelter of a lavatube, or simply *tuck themselves under this 'lith blanket*. ["lith" is a Greek root meaning stone, here, the inorganic rock-derived powder and impact debris.] Two meters does fine for limited tours of duty. Four meters (13 ft.) would be better for those intending to stay many years and raise families. Both types of blanket stop most all of the incoming radiation and most all of the incoming meteorite bombardment. Both blankets moderate day-night and seasonal temperature swings (the 'lith blanket doing the more effective job, actually.) The similarity goes further. Freeze out the Earth's atmosphere, and the snow of nitrogen and oxygen would leave a powdery blanket of comparable depth.

Unfortunately, the lunan pioneers cannot operate entirely under the shelter of this blanket. In local areas, to be sure, all pressurized habitat, office, school, factory, commerce, farming, and park spaces can be interconnected by pressurized

walkways and trafficways - a sort of "mole city". Alternately, a whole local urban complex could be laid out within a spacious lavatube. But intercity or intersettlement travel would be difficult to manage other than on the blanketed surface itself.

How will Lunans cope given the danger of accumulative exposure to dangerous radiation? A whole spectrum of strategies will be in order. Those whose occupations take them out onto the surface regularly, will wear "rad" bracelets which document cumulative exposure. They will have to rotate surface assignments with duties within shielded environments - under the blanket. When their "rad" bracelets show maximum tolerable exposure, they will be retired to sheltered duties.

Solar flares, however, are one form of exposure that do not come in averaged steady doses. Those caught on the surface during a storm risk fatal nuclear exposure. Regularly traveled routes will need to provide shielded flare sheds at intervals, reachable within an hour or so from the midpoint between them. Excursions to areas without flare sheds may be allowed only outside of flare "season". Solar activity runs in 22 year cycles, fortunately, and this regularity offers a certain assurance of safe travel at most times. Vehicles engaged in emergency excursions during the midst of the flare season? will need to be equipped to "borrow in" on a moment's notice, or to otherwise erect and blanket a Sun-facing lean-to.

Lunans will learn how to cope with their "weather" just as the folk of Wisconsin and Minnesota and even more extreme climes on Earth have learned to cope with theirs. The populace will quickly acquire a local "common sense" and they will handle it "second nature" style. What to us seems a hostile and alien world, will to them seem cautiously friendly, coaxingly nurturing. It will be no big deal.

There may be consolation prizes to this exposure to the cosmic elements, prizes of economic significance. We can not guess what they are as yet. But even as northerners have learned to make economic hay out of winter, so will Lunans learn to put this naked exposure to good use. And here we are not speaking of the high-level dust-free vacuum over the lunar surface, of certain industrial value. We are speaking of the infall of cosmic rays, ultraviolet radiation, micrometeorite bombardment, and solar flares. Surely, with enough imagination and experiment, industrial and even art and craft processes can be devised to use such exposure as a special tool.

We have suggested that a settlement's water reserves be circulated on the surface under UV-transparent quartz panes: UV exposure should kill any bacteria or other pathogens. One possible industrial tactic would be to paint a "resist" on surfaces to be protected from exposure, and thus selectively "etch" a metal, ceramic, or glass surface with radiation, UV, or micrometeorite exposure. Experiment will be needed to see if the results, as experiment parameters are modulated, offer economic value. One promising area for experimentation would be industrially crafted decoration of surfaces of consumer products for domestic consumption and export.

Attitude is everything. If pioneers adopt a mind set that sees this naked exposure to the cosmic elements as all liability, then that it will surely be. If they have the faith to see it as a blessing in disguise, they will be ready to turn this "liability" into a major asset for themselves. **MMM**



Making do without the "Outdoors"

by Peter Kokh

Relevant Readings from Back Issues of MMM

- MMM # 5 MAY '87 "M is for Middoors" [MMMC #1]
- MMM # 8 SEP '87 "Parkway" [MMMC #1]
- MMM # 37 JUL '90, p 3, "Ramadas" [MMMC #4]
- MMM # 55 MAR '92, pp 4-6 "Xity Plans" - [MMMC #6]
- MMM # 74 APR '94, p 7 "Sun Moods" - [MMMC #8]
- MMM # 89 OCT '95, pp 3-4 "Shelter on the Moon" [MMMC #9]

If the principal theaters of lunar life and activity will be subterranean (in lavatubes) or sub'lithic (under the [rego]lith blanket), the supporting roles will be "out on" the surface. Using the Australian experience as a model of sorts, in which their great relatively barren continental "back yard" is known as the "outback", we've coined the phrase "out-vac" for the lunar surface. The out-vac will be a place visited and a medium of passage rather than a place lived in. Most Lunans will never don a spacesuit except in "decompression drills" reminiscent of our fire drills. Vehicle to vehicle and vehicle to habitat "dock-locks" will allow people to travel anywhere on the Moon in "shirtsleeve environments". There will be the geologists or selenologists, the prospectors and explorers, and the overland truckers and others whose jobs keep them in the out-vac for long periods. And there will be the self-elevated rugged individualists who throw themselves into various out-vac "sports" such as out-camping, out-cycling, out-climbing, etc.

Shielded ramada canopies will offer protected "lee vacuum" for those with regular work duties just outside the airlocks and dockgates of the town or outpost. In such areas only pressure suits, not hardened space suits, need be worn.

But for most Lunans, the hostility of the out-vac will threaten a wholesale forsaking of what on Earth are "outdoor" activities. Without compensation or accommodation, this loss could be demoralizing for a significant cross-section of a normal population. Some, as we've just suggested, will find ways to fashion out-vac activities that are reasonably safe and yet satisfactorily thrilling as well as liberating from the all-so-limited confines of even the most spacious and extensive of settlement mini-biospheres. The importance of such a safety valve cannot be overemphasized.

But for the greater part of the population, the answer may lay in the creation of very generous pressurized commons, nature and picnic parks and playing fields and parkways that, while sheltered from the cosmic elements, nonetheless have an airy and supportively verdant feel to them. As opposed to the more confined spaces within individual habitat homes and edifices which they will serve as interconnectors, we have called such sheltered yet open spaces the "middoors". The middoors lie between the doors of private spaces and the airlocks and docking gates of the settlement proper.

The more generous and more high-ceilinged spaces of

the Lunan middoors can be offered by several architectural devices. Pressurized cylinders carrying vehicular traffic can have a radius generous enough to support green strips with hanging gardens, trees, walking and jogging paths, even meandering trout and canoe streams. Spherical or ovoid or torus structures can serve as more self-compact nonlinear park and nature space. Farming and food production areas can provide for public footpaths and picnic oases.

Solar access can be provided more conservatively by bent path "sundows", by optic fiber shielded "sunwells", or more radically, as Marshall Savage suggests, by water-jacketed double domes. [See the illustrations in #74 article cited above.]

Well-designed middoor spaces provided in a generous acre per citizen ratio can probably substitute for the open air greenspaces of Earth for a large cross-section of the population. Others will need to come to personal terms with the out-vac. Still others will never be able to leave behind the green hills, the ocher deserts, the blue skies, the thick forests, or the horizon to horizon expanses of ocean deep on the only world they have collectively and individually ever known.

For while we may be able to walk and hike and bike and row and trout-fish in lunar middoor spaces, many other cherished outdoor activities will be difficult to replace: skating yes but skiing and snowmobiling no. Human-powered flight maybe, but powered flight, soaring, and skydiving no. Rowing and canoeing yes, but motorboating, sailing and ocean cruising no. Caving or spelunking in lavatubes yes, in limestone caves no. Berry picking and trout-fishing yes, but hunting not likely.

Each person pondering signing up for the lunar frontier must weigh his or her attachments to cherished activities that may not be supported in lunar settlement biospheres any time soon, if ever at all. And those who take the plunge will owe it to themselves to be politically and civilly active in guaranteeing that the settlement middoors is as generous and diverse and user-friendly as economically possible. Nothing less than the morale and mental health and long-term survivability of the whole settlement is at stake. MMM

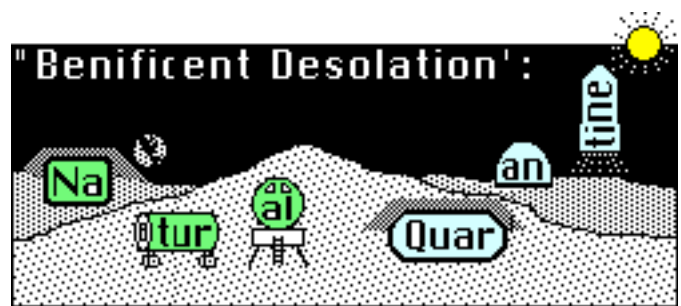

Lack of global biosphere has a silver lining

by Peter Kokh

Relevant Readings from Back Issues of MMM

- MMM # 8 SEP '87 "Colonists I.Q. Quiz": Q. 6 [MMM C #1]
- MMM # 15 MAY '88, "Rural Luna" [MMM Classics #2]
- MMM # 56 JUN '92, p 5 "Quarantine" [MMM Classics #6]
- MMM # 79 OCT '94, pp 13-15 "Lunar Roads"; "Waysides, Service Centers, and Inns" [MMM Classics #8]
- MMM # 83 MAR '95, p 5 "Tarns" [MMM Classics #9]
- MMM # 84 APR '85, p 5 "Ghost Towns & Ruins"["]

On Earth “the” biosphere is continuous, integral, and all-embracing. On the Moon, each settlement and outpost must maintain its own discrete minibiosphere, and do so very carefully. Lunans will live essentially and immediately, “downwind and downstream from themselves”. No global air circulation to diffuse pollutants, no shared ocean or boundary-defying groundwater aquifers to pollute. On the Moon, the great barren sterile out-vac will maintain a virtual mutual quarantine between all the several settlements and outposts.

Locally this discontinuity can be ‘postponed’. It will make no sense to have separate town center and suburban biospheres. Everyone living within feasible connection distance *will seek to be* interconnected. And there is virtue in this. The bigger the biosphere, the more stable and forgiving and satisfyingly rich and diverse it is likely to be, both in decorative greenery and in food and fiber producing plants. That does not mean there may not be separate political autonomies with their own little school district and zoning peculiarity fiefdoms etc. But the important thing, the biosphere, will be a shared metropolitan responsibility. There may be some few separate neighboring installations, but these will be industrial facilities where prudent separation is maintained in case of a potentially polluting accident.

The biological quarantine that will reinforce the separateness of discrete outpost and settlement biospheres will offer an important plus. We’ve never built / developed / grown mini / artificial biospheres before, and the risk of biological collapse through imbalance, disease, or mismanagement will be higher than we would like - certainly for several generations to come. The provident availability of quarantine through the aegis of surface vacuum and the absence of groundwater will provide distributed, rather than shared vulnerability.

If there is disease or wholesale biological collapse in any one given minibiosphere, the chances of containing it there locally are greatly enhanced by this quarantine. Infection can be carried in by travelers and visitors, of course, but the odds of prevention are clearly enhanced by this separation.

Another benefit of this natural quarantine is that the town fathers and citizenry in each case can choose their own flora and fauna combinations, their own climate and regimen of seasons. “See one lunar town, and you’ve seen them all?” No way! Each can have its own natural ambiance, enhanced by differences in city plan, prevalent architectural styles, etc.

This quarantine-enabled variety will not only make the Moon a more interesting place for terrestrials to visit, it will draw the visiting Earthlubbers to visit more settlements, not just the main one(s), distributing income from tourism more fairly. Towns will choose their floral and faunal mix as well as architectural styles and other elements of distinctive and alluring ambiance accordingly.

For Lunans themselves, the result will mean realistic possibilities to “get away” and experience wholesome “changes of scenery” on vacation holidays as well as in business travels. Those needing to relocate and start their lives “over”, will have the chance to do so. As on Earth, Lunans will be able to relocate for “life style” reasons.

The desolation of the out-vac is not only “magnificent”, it is truly “beneficent”. More next month! 

Lagrange Point Staging for Lunar and Planetary Flight

by Larry Jay Friesen - [References on page](#)

[Larry Jay Friesen is a physicist by education, and has worked for a number of years with various aerospace contractors at Johnson Space Center. He has worked in the area of orbital dynamics and currently is with the Hypervelocity Impact Laboratory. Larry is an Artemis Society member, serving on the Mission Design Technical Committee.]

Introduction

I would like to propose for consideration by would-be Lunar pioneers, a location for staging traffic between Earth and the Moon - once a lunar base has been established. The same orbital location, surprisingly enough, could make an excellent place for staging interplanetary space flights.

I am referring to the L1 Lagrange point in the Earth-Moon system. I am not the first to consider this orbit as a useful place for a base. Keaton discussed Lagrange point bases as possible staging locations at the first Lunar Base Symposium in 1984 [1]. Farquhar [2] had recommended a Lagrange-point station as an element of an Earth-Moon transportation system in 1972, although he preferred the L2 point beyond the Moon.

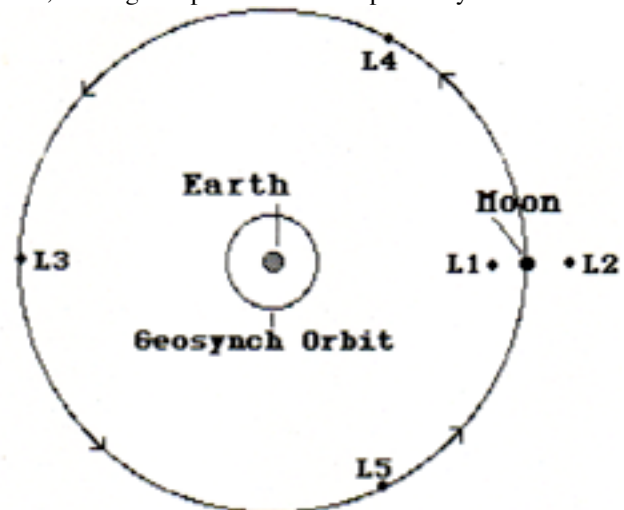

Figure 1 Orbital locations in the Earth-Moon neighborhood, showing Lagrange points.

L1 is an orbit between Earth and the Moon, located approximately 58,000 km [36,000 mi] this side of the Moon. An object placed there with the right initial velocity would orbit Earth in step with the Moon, remaining along the Earth-Moon line throughout each lunar month. The actual orbit selected for such a base may turn out to be not exactly *at* the L1 point, but in what Farquhar calls a “halo orbit” around it, such as he suggested for his proposed L2 base [2]. However, details of orbits are subjects for further study, and the L1 point proper will do for the present discussion.

The most efficient way to reach L1 from low Earth orbit (LEO) (and to return to LEO from L1 is via a lunar swingby trajectory, in which the spacecraft does a figure 8 around the Moon, as the Apollo capsules did, and performs a course adjustment maneuver (“burn”) to send it to L1, and then a final burn at L1 to change course and speed to the L1 orbit.

When people think of putting staging bases for lunar missions near the Moon, they are often thinking of bases in low lunar orbit (LLO), a few tens to a few hundreds of kilometers above the lunar surface. Why do I want to put a space station so far away?

There are advantages for having an L1 space station over an LLO base that apply to Earth-Moon traffic. There are others that pertain to manned interplanetary flights.

L1 Advantages for Lunar Base Support

To begin with, an L1 base offers great adaptability for supporting lunar surface operations. From L1, it is possible to launch at any time to any location on the lunar surface for a similar delta-velocity (ΔV) and flight time interval. For those not familiar with the term, ΔV ["delta-V"] is the sum of the velocity changes for all the maneuvers a spacecraft must perform in order to accomplish a given mission, or a major portion of a mission. It allows planners to estimate propellant requirements for the mission. Propellant requirements tend to go up much faster than ΔV . For example, doubling ΔV for a mission would more than double the propellant requirements.

Mission ΔV from L1 to the lunar surface is approximately 2.76 km per second, a little over lunar escape velocity, (unless you're in a hurry, in which case it is more), and the flight time is 3 to 4 days (again, unless you're in a hurry). Likewise, you can launch from any place on the lunar surface to the L1 base at any time, for the same ΔV and flight time.

But an LLO base circles the Moon every 2 hours or so, so it shouldn't take more than about 3 hours at most to get down, and the ΔV cost is only lunar orbital velocity, or 1.7 km/sec. So where's your advantage?

That 3-hour time span and 1.7 km/sec. ΔV represent the best case. That best case occurs if the lunar surface base is in the orbit plane of the orbiting station. Only two situations can guarantee that the surface base will always be in space station's orbit plane. One of those situations is if the surface base is on the lunar equator and the space station is in the Moon's equatorial plane. The other is if the space station is in lunar polar orbit, and the surface base is located at either the north or south pole of the Moon.

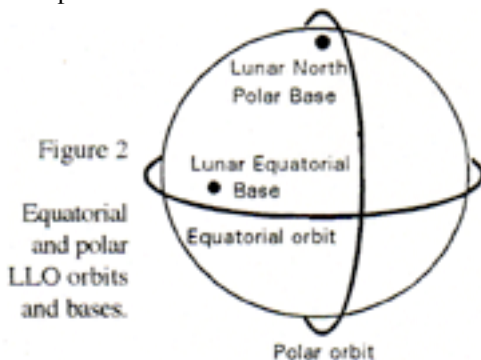

But what if we want more flexibility in our surface base location? Or what if we want to support several surface bases at different locations on the Moon? The one type of orbit which can overfly every spot on the Moon is a lunar polar orbit. Problem is, you have to wait until the Moon rotates under you, to reach any given spot on the lunar surface. If you are lucky, the surface base may be in your orbit plane now. Otherwise, it could mean a wait of anything up to 14 days.

Suppose there is some emergency, and you have to get a spaceship down to the surface, or from the surface up to the space station, as quickly as possible, and you can't afford to wait 14 days? Then you will have to do a plane change before descending (or after ascending). Orbit plane changes are very expensive in ΔV , and thus in propellant. In the worst case, if the surface base is 90° away from the current station orbit plane, the ship will have to do a 2.4 km/sec. burn to change planes and then pay the 1.7 km/sec price to reach the surface, for a total ΔV of 4.1 km/sec.



Figure 3. 90° orbit plane change and descent from LLO.

So we see that in the best case for a LLO base, it beats the L1 base for wait time and ΔV to and from the lunar surface. But in the LLO base's worst case, the L1 base wins. And we recall that the L1 base gives us a much more predictable, and at the same time much more flexible, mission scenario. Launch windows are essentially unlimited.

Another comparison of interest is station keeping. Space stations in either orbit will have to perform propulsive maneuvers from time to time to maintain their required orbits, and will require propellant to be supplied for that purpose. A station in LLO will have its orbit perturbed by the gravitational tugs of Earth and the Sun. The eccentricity of its orbit will be changed over time from the initially circular orbit to one more elliptical. The perilune (point nearest to the Moon) will be lowered and the apolune (farthest point) will be raised. L1 is not one of the stable Lagrange points. The station will eventually begin to drift away from that position if its orbit is not corrected.

According to Farquhar's estimates, the ΔV requirements for such station keeping are rather similar for both LLO and L1 bases: on the order of 120 meters/second/year. The consequences of *failing* to perform the station keeping maneuvers, however, are not. For orbital altitudes typically quoted for LLO studies, 100-200 kilometers above the lunar surface, perilune would be lowered so much that the station would crash onto the surface of the Moon in a matter of months. An L1 station would drift away from the L1 orbit, but would most likely remain somewhere in the Earth-Moon vicinity. This gives a much better chance for rescuing the crew, and perhaps even of inserting the station back into the desired orbit.

L1 also appears to offer more advantage from lunar derived propellant than LLO. As the companion article to be published in next month's MMM discusses, transportation costs for supporting a lunar base can be reduced if at least part of the propellant for the spacecraft can be produced on the Moon. It will be a lot easier if we have gas stations at both ends of the run.

It has been widely publicized that oxygen can be

extracted from lunar rock both for breathing and for use as propellant. Aluminum plus oxygen, for example, makes a decent rocket propellant combination. They may also be combined with hydrogen, as described in the companion article, for a high performance tri-propellant combination. If we are using lunar-derived propellants for the ships traveling between our space station and the lunar surface, making L1 rather than LLO the transfer point uses lunar propellant for a greater portion of the Earth-to-lunar surface voyage, and thus requires less propellant be lifted from Earth.

One reason why I prefer L1 over L2 as a station location is that I expect early lunar bases to be on the near side of the Moon, and L1 could supply a great deal of support for lunar surface operations. For one thing, it could act as a communication relay for almost the entire lunar nearside, linking bases to each other (if there are more than one) and to exploring expeditions that may be on extended traverses hundreds or thousands of kilometers from any base.

Just as an L1 space station could relay communications, so it could relay power. If a solar power satellite were included in its design, it could beam power to nearside surface bases, greatly reducing their power storage requirements. A lunar surface base (except at the lunar poles) is in darkness half the time, which will require it either to have energy storage capacity for two weeks at a time, or to use nuclear power. A station in L1 orbit is in shadow no more than a few hours at a stretch, a couple of times a year, during lunar eclipses [at other full moon situations, L1 along with the Moon will either be above or below the Earth's shadow].

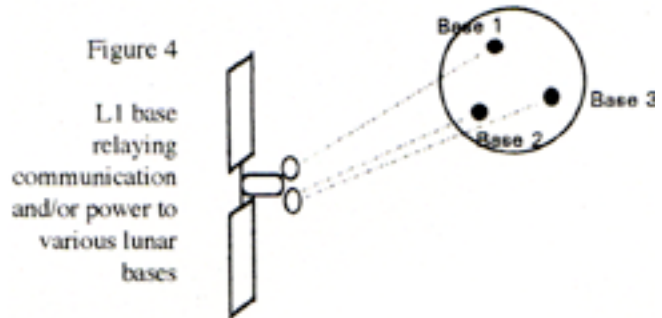

L1 Advantages for Interplanetary Flight

In addition to being an excellent support base for lunar surface operations, an L1 station would have significant advantages as a base from which to launch and recover human-crewed interplanetary vehicles. These advantages include:

- (1) saving large amounts of propellant by using Earth swingby or "gravity slingshot" trajectories to launch and recover the vehicles and
- (2) use of lunar-derived propellants as a majority of the propellant mass to fuel the craft.

A gravity slingshot trajectory begins with a reverse of the lunar swingby used to reach L1 from LEO. A spacecraft departs L1 with just the right velocity change to swing it past the Moon as though it were returning to Earth. It passes close to Earth, but instead of breaking into LEO, it accelerates, adding enough velocity to hurl it onto its interplanetary trajectory. It is already moving at nearly Earth escape velocity before the burn, having gained most of that velocity from

gravitational potential energy in its fall from the Moon toward Earth. Because of the spacecraft's already high speed, the burn ΔV does not have to be large. Figure 5 illustrates such a "triple thrust" slingshot departure from L1 for an interplanetary trajectory. It would not be efficient to bypass the slingshot maneuver and launch from L1 directly into an interplanetary trajectory. That would fail to take advantage of the kinetic energy gained from falling toward Earth and would take much more propellant.

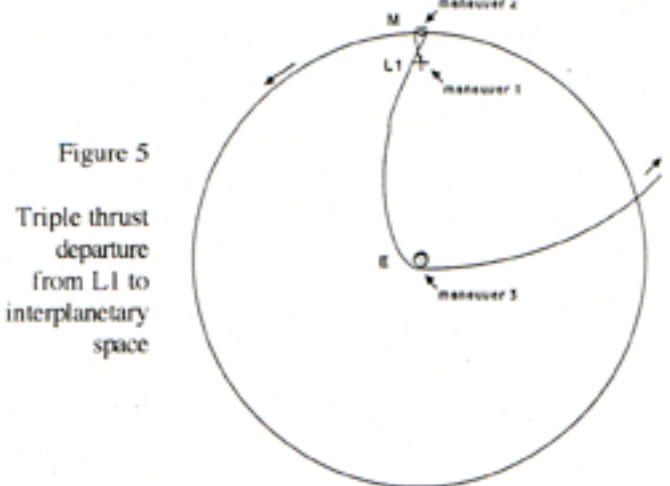

Table 1 shows a comparison of ΔV requirements for an L1 launch vs. a LEO launch for a Mars mission. The L1 launch Maneuver 1 and Maneuver 2 ΔV figures are based on Farquhar's figures for reaching L2 [2] and may need checking. However, they are unlikely to be in error by as much as a factor of 2. We see that launching from L1 saves on the order of 2.5 kilometers per second of ΔV over a launching from LEO for an outbound trip to Mars. The return trip requires the same ΔV amounts as the outbound trip to reach either L1 or LEO, so savings will double.

Table 1. Mars Mission ΔV Requirements, L1 vs. LEO launch

L1 launch		km/sec
At L1 ¹ :	Initiate Lunar swingby	= ~0.15
At perilune ² :	Switch to Earth flyby	= ~0.20
At perigee ³ :	Initiate Mars transfer	= 0.79
	Total near-Earth ΔV	= 1.14
At Mars	Entry into low Mars Orbit	= 2.08
	TOTAL one way ΔV	= 3.22
LEO Launch		
At LEO:	Initiate Mars transfer	= 3.65
	Total near Earth ΔV	= 3.65
At Mars	Entry into low Mars orbit	= 2.08
	TOTAL one way ΔV	= 5.73
ΔV saved	by launching from L1	= 2.51

¹: maneuver 1 of Figure 5; ²: maneuver 2; ³: maneuver 3.

One study I was involved with at Lockheed assumed a three-stage Mars exploration ship launched from LEO [3]. When we considered launching from L1, we found we could omit the entire first stage.

Part of the ΔV for the return trip could be accomplished by aerobraking in Earth's atmosphere, rather than by a propulsive burn. But here, too, return to L1 would

have an advantage over return to LEO. The perigee maneuver at Earth would only have to cut the velocity by 0.79 km/sec to put the spacecraft on a trajectory to L1. This is a lot less than the 3.65 km/sec needed to brake into LEO. That means a lot less kinetic energy converted to heat, so the aerobrake could probably be made much smaller and lighter (which in turn means less propellant to haul it to Mars and back).

Similar ΔV and propellant savings will apply to any interplanetary flights launched from L1 (including to asteroids). The reason is that most of the mass for an interplanetary mission does not consist of people or payload. It consists of propellant ... and as we have already noted, propellant requirements for a mission increase much more rapidly than ΔV requirements.

But you may be saying to yourself, I still have to get my ship, crew, payload and propellant from Earth up to L1 to begin with. When you raise this question, you are on to an important point. The scheme of using L1 as Earth's interplanetary port only makes sense *if* the ships can use lunar derived propellant, *and if* we plan on repeated interplanetary voyages. If we plan on making only one Mars mission with people on board, or two or three, then we might as well assemble and fuel them in LEO and forget L1 basing.

However, we have already discussed some possibilities for getting propellant from lunar sources. Any propellant made at the Moon will *not* have to be brought up from Earth. If the interplanetary ships use hydrogen/oxygen propellant, lunar oxygen could make up 5/6ths of the propellant mass (using Shuttle combustion ratios). That's quite a saving.

We have also discussed lunar aluminum as propellant for lunar landing vehicles and possibly for Earth/Moon ferries. Aluminum and oxygen alone may not have the specific impulse designers would want for a Mars ship. (Specific impulse is a performance measure for rockets somewhat analogous to miles per gallon. It is often given in units of seconds, meaning the number of seconds that one pound of propellant could produce one pound of thrust, before it is consumed.) However, as discussed in more detail in the sequel companion paper, a concept for an aluminum/hydrogen/oxygen *tripropellant* combination has been put forth by Andrew Hall Cutler [4]. At an H:O:Al mass ratio of 1:3:3, such an engine is expected to have a specific impulse exceeding 400 seconds - only slightly poorer than hydrogen and oxygen alone. An engine of this type might be worth considering for interplanetary vessels as well as for vessels on the LEO-Moon run.

The second requirement for L1 launches to be advantageous is to have repeated interplanetary trips, and to return to L1 as well as start voyages there. That way, you build a ship once, and only once have to lift the structure from LEO to L1. For all subsequent voyages of that ship, you will only have to ferry people, payloads (the less massive elements of the [loaded] vehicle) and (maybe) propellant hydrogen from Earth. The major portion of the propellant (and the majority of the initial mass of the [loaded] ship) will be Moon-derived.

Establishment of an L1 space station to support both lunar surface operations and interplanetary voyages would offer significant advantages in flexibility and efficiency to each, and an opportunity to "kill two birds with one stone".LJF

References for Friesen article, above:

- [1] Keaton, Paul W. "A Moon Base/Mars Base Transportation Depot", *Lunar Bases and Space Activities of the 21st Century*, W.W. Mendell, ed., Lunar & Planetary Institute, Houston, (1985) pp. 141-154.
- [2] Farquhar, Robert W. "A Halo-Orbit Lunar Station", *Astronautics & Aeronautics*, (June, 1972), pp. 59-63.
- [3] Friesen, Larry Jay & Bridget Mintz Register. "Space Station Accommodations for Manned Lunar and Mars Initiatives", Lockheed Engineering and Sciences Co. for Advanced Projects Office, NASA-JSC Houston (1989).
- [4] Cutler, Andrew Hall. "Aluminum Fueled Space Engines for Economical Lunar Transportation". *Lunar Bases and Space Activities of the 21st Century*, W.W. Mendell, ed., Lunar and Planetary Institute, Houston, (1985) p. 61.



"THAT'S MR. JONES PLACE, HE'S THE TOWN LAWYER."

Dennis Cripps cartoons, above, below

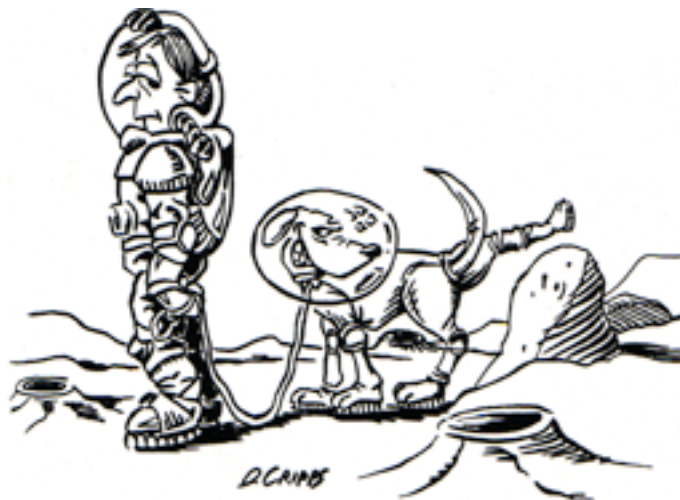

Shielding Artemis Moonbase

From Greg Bennett on Category 28, Topic 46, Nov 21, 1995
SHIELDING . . . Jim Nobles asked about this one.

We can rely on the thermal mass of the habitat and heaters for a while. The reference mission calls for having the robot pile up the insulation after the crew has headed home. We wouldn't want the crew shoveling dirt during their short stay. The space station relies on just a few layers of insulation

to handle the temperature extremes, so we should be able to get by for a while with insulation. Of course, the space station is snuggled up to a nice, warm planet throughout its life.

So this becomes a challenge for the robotics technical committee more than anyone else.

The basic concept -- and it's no more than that -- is to use some equipment added to a derivative of the rover that Carnegie-Mellon Univ. is working on in the partnership with LunaCorp. Our thinking was to put a bolt pattern on the rover's structure to accommodate the added equipment (whatever it is), and connectors for power and data. The basic design provides mobility, high-resolution video, power, navigation, and communication.

We haven't yet worked out how much mechanical power is needed to move dirt or how to protect the robots at night. We also haven't worked out any numbers on thermal stability and how fast the lunar base will lose heat before we can put a blanket over it. So right now we're going on a gut feeling; *my* gut feeling, a fact which scares me -- the only reliability there is trusting intuition derived from several years of designing spaceships and reading hundreds of technical papers about lunar bases. With that caution in mind: my gut feeling is that the habitat will make it through at least one lunar night with no problem. I'm more worried about the robot itself because the robot is more exposed to heat loss.

Next summer CMU is going to test the lunar rover in the desert. That gives us a timeframe for learning more about what it can really do, and developing conceptual mission plans to test against the rover's capabilities.

This whole area needs a lot more creative thought and serious number-crunching. The idea of making bricks is a new one. I don't know what kind of equipment we'd need for bricks. Some folks poo-poo the idea of sandbags but I don't know why.

The simplest solution might be as you said, Jim: just pile dirt on the module. If access to the external side of the pressure shell is an issue, we might have the crew throw a tarp over the module and provide standoffs to support it away from the pressure vessel.* The robot would then be building a cave around the module. Moon dirt tends to stick to itself (and everything else) so that cave might turn out to be quite rigid after rolling a rover over it a few times.

* [ED. COMMENT: Internal air pressure within the habitat would be sufficient to bear the load of well over 100 feet of soil placed on top - far more than the 6-13 ft. contemplated. We may want to provide "standoff", however, wherever there are habitat surface connections needing maintenance.]

We'll make it beautiful: give the robot a trowel and a manipulator arm to carve pretty designs in the dirt or something.

Purpose of the first mission, and then some . . .

The goals of the first mission are to:

1. Establish a permanent habitat
2. Leave the transportation system in space
3. Demonstrate private enterprise can do manned space flight

We're hoping we'll also be able to have the crew assay the site and do some exploring on the first mission, so the next crew will know what to bring with them. If we have some weight margin, a small pilot plant for processing lunar soil to

extract its oxygen is a high priority. Processing other volatiles and even smelting metal using solar power are also high priorities, even if these are only tiny little experiments no bigger than a briefcase.

Very high on the priority list is to leave the telero-botic capability in place so that the mission can continue after the first crew has come home. The crew might have to do some refurbishment work on the robot, replace batteries or solar panels, clean off dust (if they can), or erect a shelter for the robot.

Of course, if the science community would like to sponsor scientific goals for the mission, we'd be more than eager to accommodate their desires.

The permanent habitat becomes the exploration base and construction shack for the next flight, where we get down to serious work. Since the second crew will already have a habitat waiting for them, they can carry more industrial and exploration equipment. Mining, materials processing, and finding lava tubes are all urgent.

It's not inconceivable that the first flight could earn enough money to pay for one or more subsequent flights, but the entertainment value of this venture will diminish until both the lunar base and LEO transportation systems reach the point where lunar tourism is economically viable. So we need to demonstrate as early as we can that we are able to build habitats on the moon and fly people there using commercial aerospace standards and practices.

If we can do that, and the LEO transportation system comes together, we should be in a position to seek real capital to fully develop lunar tourism as an industry. That reduces the cost for everybody, and planetary scientists will find that a field trip to the moon is reasonable. A stable business -- any stable business -- will open the floodgates; it's all uphill from there.

GB

Relevant Readings from Back Issues of MMM

[Republished in MMM Classics #1]

MMM # 1 DEC '86, p 2, "M is for Mole"

MMM # 5 MAY '87 "Weather"

[Republished in MMM Classics #3]

MMM # 25 MAY '89, p 4, "Lava Tubes"

[Republished in MMM Classics #4]

MMM # 37 JUL '90, p 3, "Ramadas"

[Republished in MMM Classics #6]

MMM # 55 MAY '92, p 7, "Moon Roofs"

[Republished in MMM Classics #8]

MMM # 74 APR '94, p 5, "Shielding and Shelter"

[Republished in MMM Classics #9]

* MMM # 89 OCT '95, pp 3-5 "SHELTER on the Moon: Digging in for longer, safer stays."

Other Readings

"Lunar Base Design" by Peter Land, Illinois Institute of Technology, College of Architecture, Chicago, in "Lunar Bases and Space Activities of the 21st Century" pp. 363-73, Ed. Wendel Mendell, Lunar and Planetary Institute, Houston 1984, ISBN 0-942862-02-3

MMM #95 - MAY 1996

Towards a Calendar for the Moon

While there will be reasons why some future Lunan pioneers might want to use the familiar international calendar of Earth, reasons for starting fresh with their own date keeping system may be more powerful. On the Moon, the pace of Earth's seasons will be irrelevant. Timing of local sunrise and sunset will dominate everything. BELOW: sample permanent calendar customized for local sunrise/sunset pattern.

Firstsun (odd # sunths)							Secundsun (even # sunths)						
A	C	E	Ma	Me	S	T	A	C	E	Ma	Me	S	T
1	2	3	4	5	6	7	1	2	3	4	5	6	7
8	9	10	11	12	13	14	8	9	10	11	12	13	14
15	16	17	18	19	20	21	15	16	17	18	19	20	21
22	23	24	25	26	27	28	22	23	24	25	26	27	28
29							29	30					

For more Lunar Frontier calendar options, => below

[Continuing a New MMM Series]

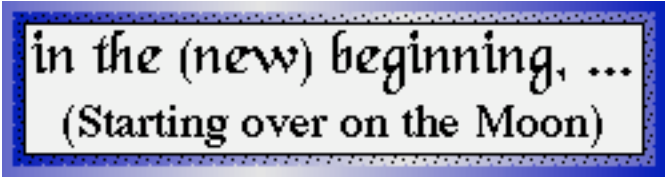

The primitive roots of "Lunan" Culture, II

Last month we talked about the brute physical realities that will begin shaping Lunan culture from the day of our return and the establishment of the first overnighting beachhead outpost — fractional gravity, naked exposure to the cosmic elements, and the natural quarantine between outposts.

We continue the story with those brute physical facts that will insert themselves, if not on day one, then shortly thereafter to begin carving nascent Lunan culture even more deeply. — The Moon is a very dry world. And its mineral assets lack several of the industrially strategic elements Earth's more generous endowment has lulled us into taking for granted. 



by Peter Kokh

Relevant Readings from Back Issues of MMM

- [Republished in MMM Classics #3]
MMM # 23 MAR '89, pp 4-5 "Gas Scavenging"
- [Republished in MMM Classics #5]
MMM # 44 APR '91, pp 5-6 "Ice Caves"

[Republished in MMM Classics #6]
MMM # 51 DEC '91, p 5 "Ice Found on Mercury!"

[Republished in MMM Classics #7]
MMM # 67 JUL '93, pp 3-8 "Water & Hydrogen: lunar industrial grease"; "Hydro Luna"; "Reservoirs"; "Settlement Water Company"; "Xeroprocessing"

[Republished in MMM Classics #8]
MMM # 78 SEP '94, p. 3 "Why hotter Mercury may have polar ice while the colder Moon may have little."

Compared to the Moon, **Tatooine**, of Star Wars I fame, would be a paradise oasis world. Away from the lunar poles, you can encircle the Moon, a 6,800 mile trek, without finding water. The closest thing to even the false comfort of a mirage will be Earth's blue oceans hanging tauntingly overhead in the black Nearside skies, some 238,000 miles away.

At the poles the story *may* be different. Volatiles such as water and carbon oxide molecules released on impact from rare cometary bombardment during local nightspan may have found their way to the safety of polar permashade coldtraps before local dawn, there to freeze out on the floors of craters whose interiors never see the rays of the Sun. The jury is still out on this, though indirect readings from **Clementine** over the lunar south polar region have been very teasing. Most sober estimates have been that the various loss mechanisms likely to be in effect (erosion from the solar wind, cosmic ray bombardment, micrometeorite rain) are likely to swamp the assumed rate of accumulation. That is, any ice deposits would be ephemeral and erode away or sublimate over time.

There is no one making such an estimate who would not be delighted to be proven wrong. Hopefully, we will not have long to wait. **Lunar Prospector**, next in line in NASA's Discovery Mission series, is due for launch next summer, equipped with precisely the right instruments to give us a definitive answer to the question. Any ice deposits **Lunar Prospector** might miss are probably too skimpy or thin to be of near term economic value.

The positive finding of substantial ice fields at the poles of Mercury, a world much closer to the Sun, has encouraged many. But Mercury's accumulation mechanisms may be significantly stronger. We simply have to wait and keep our fingers crossed, determined, should the results from **Lunar Prospector** prove negative, to make the best of "Plan B".

"Plan B" is to scavenge the hydrogen nuclei or protons adsorbed to the fine particles of the upper meter or so of the regolith, thanks to the incessant buffeting of the lunar surface by the Solar Wind over the past 4 billion years plus. Hydrogen is present in this surface layer on the order of 1 ton of hydrogen per 10,000 of rock powder (regolith) along with lesser amounts of other volatiles: carbon, nitrogen, helium, neon and other noble gasses. 10,000 tons of regolith is the equivalent of the material removed from an excavation 3 meters deep by 30 meters wide and 40 meters long. Equipping all our 'lith-moving equipment to heat the material handled in order to extract these gases for later separation would be a prudent and provident strategy. We have called this process "primage".

Just how much water does this hydrogen source represent? One ton of hydrogen with 8 tons of oxygen (super abundant) yields 9 tons of water. If we could extract all the

Moon's hydrogen to produce water, we could in theory cover all the lunar maria to a depth of say a centimeter or 3/8ths of an inch (and guess how fast that would soak in!!) Or we could make a crater lake 60 miles across and 30 ft. deep. Gathered all together it seems like a lot, but for the whole Moon? It's really very very little. No desert on Earth is as parched as the Moon. The Gobi, the Sahara, the Kalahari, the Takla Maklan - they are all dripping wet in comparison.

Even if **Lunar Prospector** confirms substantial water ice reserves at either or both poles, tapping them will not be easy. The ice temperature is likely to be extremely cold, the ice very hard and resistant to harvesting machinery which will be prone to break down all too frequently.

And should engineers come up with a simple smooth running system to extract this frozen wealth, how fast can we harvest it and put the water to work? In comparison to the rate at which these conjectured ice fields were laid down, *any* rate of extraction will completely swamp the rate of replacement. In other words, for all practical purposes, like oil on Earth, lunar polar ice is not a renewable resource. It behaves us to use it wisely. The number one demand will be for cryogenic rocket fuel. Make that number one in obscurity as well. We'd do best to use other lunar-sourceable fuels and save the water for recyclable uses in industry, agriculture, and biosphere support.

Will reason prevail? The temptations of impatience are always the strongest. A sustainable human culture on the Moon will have to be built on alternatives. Water-ice at the poles or no, Lunan culture will be characterized with an attention to water conservation beyond anything we have experienced on Earth, even in drought-stricken regions. Water is the blood of the biosphere. It is not free.

To what extremes will water conservation be carried? We have already spoken of the need to rethink airlocks to conserve nitrogen. The same will be true of water vapor. Conduits or pipelines and tankers carrying water or hydrogen in other forms (methane or ammonia, for example) will have to be designed for instant leak detection and ready repair. Materials of any kind with a hydrogen content (carbon or nitrogen too, for that matter) will need to be religiously recycled and reserved for intensive usage purposes.

Will Lunans carry things as far as the Fremen in the great Frank Herbert science fiction epic "Dune"? The desert-living Fremen wore "stillsuits that recycled their perspiration and urine into drinking water. Lunans may try.

We are used to life on a water-rich world with oceans, lakes, rivers, underground aquifers, and dependable rainfall. On the Moon there is none of this. Think for the moment of the ratio of plant matter to human matter. There is much more total mass of the former. Then think of the ratio of water to plant biomass. Again there is much more of the former. Will we be able to reproduce such healthy ratios within mini lunar biospheres? Both ratios on the Moon are likely to much smaller, not too much above safety margins and dependent on high efficiency short-cycle turnarounds. That could be a prescription for disaster as it leaves little room for error or accident or other unplanned misadventure.

Reserves will have to be built up through frugality in usage. At the same time, every opportunity to add to those

reserves from external sources must be taken within the limits of affordability.

We talk of a lunar settlement becoming self-sufficient. Ability to self-manufacture a large portion of its needs for domestic consumption is one thing. Ability to survive an interruption of lifeline supplies from Earth is something else. The umbilical cord can only be replaced with a yolk sac, that is with ample reserves of all vital supplies. Foremost among those are water, nitrogen, and carbon - scarce on the Moon, polar reserves or no.

Unlike us Earthlings, Lunans will hardly take air and water for granted. Culture and the language itself will be transfigured by a high degree of attention to the conservation and renewal of these resources. Those who in the early days may have mined lunar polar ice for rocket fuel will go down in Lunan history books as trashing plunderers, no matter what their other accomplishments. Transportation is not everything nor the only thing and there are alternatives. Other lunar-sourceable fuel combinations and the rocket engines to burn them need front burner development, not continued consignment to paper studies on library shelves.

Because of this high danger of misuse, and of further postponement of development of alternatives, positive findings by **Lunar Prospector** should be greeted with concern by the thoughtful. But amidst all the excitement, who will want to listen to words of caution? There may never be a Lunan culture if we do not. MMM

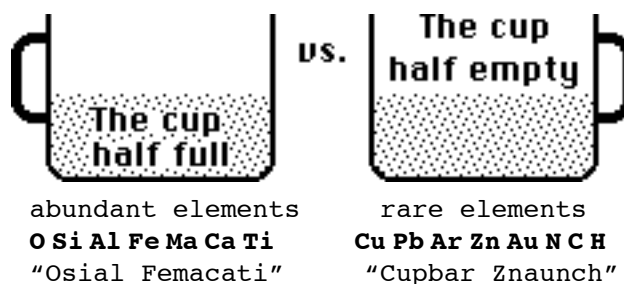

The Moon's Split Personality

Q.: Is the Moon's personality better defined by the elements in which it is richly endowed - (Oxygen, Silicon, Aluminum, Ferrum = Iron, Magnesium, Calcium, Titanium) — or, by the elements in which it is critically, strategically deficient (Cuprum = copper, Plumbum = lead, Argentum = silver, Zinc, Aureum = gold, Nitrogen, Carbon, Hydrogen) - ??

by Peter Kokh

Relevant Readings from Back Issues of MMM

[Republished in MMM Classics #1]

MMM # 4 APR '87, "Paper Chase"

MMM # 6 JUN '87, "Essays in 'M': Missing Volatiles; Methane and 'Mmonia; Minimizing import costs"

[Republished in MMM Classics #2]

MMM # 13 MAR '88, "Apparel"

MMM # 16 JUN '88, "Glass Glass Composites"

MMM # 18 SEP '88, pp 3-4 "Lunar Industrial MUS/cle"

MMM # 20 NOV '88, pp 5-6 "Ceramic Houses"

[Republished in MMM Classics #3]
MMM # 22 FEB '89, p 2, "Lunar Ores", S. Gillett
MMM # 23 MAR '89, pp 4-5 "Gas Scavenging"
MMM # 29 OCT '89, p 7 "Possible Lunar Ores", S. Gillett

[Republished in MMM Classics #4]
MMM # 32 FEB '90, pp 3-4 "Import-Export Equation"
MMM # 38 SEP '90, p 4 "Introductory Concepts of
Regolith Primage"

[Republished in MMM Classics #7]
MMM # 63 MAR '93, pp 4-10 "Beneficiation of Poor
Lunar Ores"; "Sintered Iron from Powder"; "Alloys
& Lunar Appropriate Metallurgy"; "Glax";
"Ceramics"; "Color the Moon"

MMM # 65 MAY '93, pp 4-8 "Silicone Alchemy";
"Sulfur-based construction stuffs";
"Moonwood: sulfur-based composites";
"MUS/cle Substitutions"; "Stowaway Imports"

It is most vitally important that *all* those interested in bringing the Moon into an expanded human economy, with genuine settlement of its "magnificent desolation" in the process, **understand the exact nature of the challenge** facing those who would put lunar assets to good use profitable enough to make their fledgling pioneer frontier community economically self-sufficient. — It is *so important*, that we risk ridicule in suggesting the above mnemonic "names" of the Moon's alternate chemical personalities - the *cup-half-full* and the *cup-half-empty*, respectively.

'Osial Femacati' versus 'Cupbar Znaunch'

Just as millions of astronomy students have successfully learned the proper sequence of stellar spectral types from hottest to coolest, via the insipid ditty "**Oh Be A Fine Girl, Kiss Me**", so perhaps millions of space development advocates will gain a better handle on the pluses and minuses of lunar assets through these equally insipid and weird "names".

So if you can resist your sense of self propriety and attempt to learn these two ditty names, you won't be sorry! If you can keep the lunar-have and have-not element lists straight without such mnemonic aids, fine. Quite frankly, only those who know "the score" will be prepared to help find solutions.

Together the two lists point to the need for a compound strategy of making do, finding workable substitutes, stowaway imports, and out-source development.

The lists are both incomplete, of course. The Moon has other elements in lesser but still sufficient quantities to be economically producible (e.g. Manganese, Chromium, Cobalt, Sulfur, Vanadium, Phosphorus, Potassium etc.) Likewise, there are other elements in which its share is less than we would like (e.g. Boron). But those above are arguably the most important and most illustrative. Together the two lists point to the need for a two-pronged mutually complementary strategy of making do with workable substitutions, stowaway import policies, and of out-sourcing alternatives.

The suite of available metal alloys will be affected, as metallurgists find themselves constrained to use alloying ingredients that are available on the Moon, not necessarily those they are used to using. Aluminum, for example, is in

abundant supply. But on Earth it is customarily alloyed with varying amounts of copper, an insignificant trace element on the Moon. Glassmakers, used to an abundant supply of Boron will have to find other formulae that work. Glazers will not be able to count on lead as a flux and brightener.

For most pioneers, the real differences in how they live will spring from the scarcity of hydrogen, carbon and nitrogen. What is available will preferentially have to be reserved for the biosphere and food production cycles. That means no paper, no plastic, no wood consumer products. We'll have to make do with glass and glass composites, ceramics, and metals. On the plus side, that will make for a safer, less fire-prone environment. In hermetically sealed lunar habitats, fire cannot be tolerated, cannot be allowed to happen.

An exception may need to be made for next-to-skin fabrics. Cotton or paper would seem to be the most sensible options. They would have to be organically grown and processed so that upon discard, they can be recycled easily back into the biosphere. Fortunately there is much ongoing research in this direction. Naturally colored cottons are now on the market under the Foxfiber™ name.

These strictures will govern the available options for home interior decoration and furnishing. Resourcefulness of artist and craftsman and designer alike should have no trouble rising to the occasion. Fiberglass fabrics can provide color and acoustic benefits. But since they resist abrasion poorly, i.e. do not wear well, they will be confined to walls not floors, to the outfacing sides of sofas, not the seating area, etc.

Sandals will use less organic or synthetic material than conventional shoes. Metals, glass, and ceramics will be adornment staples. Chain mail, a medieval art form still kept alive today by clubs fascinated by period clothing, could make a comeback on the Moon. It would be our recommendation that a lunar settlement library be extraordinarily well stocked in books about ethnic and primitive arts. In many ways the lunar artist and craftsman will have to start over and such sources could provide much inspiration and many resourceful suggestions.

Given the small market of lunar settlers, the extraordinary mass produced variety which we are accustomed to finding in our terrestrial malls and specialty shops will not be available. The role of the amateur Lunan artist and craftsman in customizing plain unadorned stock "issue" items from tableware to clothing to home furnishings will be critical. The Lunar settlement will give rise to an unprecedented renaissance of arts of all kinds. As a result the Lunan artist and craftsman may enjoy a prestige and place of honor in Lunan society that their counterparts have seldom if ever experienced on Earth.

For gems and jewelry, synthetic carborundum (an aluminum oxide) gems like ruby, sapphire, and emerald will be available, but not diamond which is carbon, nor pearl. Aluminum and stainless steel will replace gold, silver, platinum, copper, brass, and bronze. Small amounts of rich-grained hardwood may be as prestigious in a wedding ring as diamond is to us.

Musical instruments which use brass will need to be redesigned or forgotten. Sound boxes for string instruments will have to be metal, glass, or ceramic. Lunan music should

quickly take on a very distinctive new range of sounds. We predict, that after some getting used to, the effect will be pleasing and popular on both worlds.

Say goodbye to plastic toys as we know them. Some easily recycled plastic formulations, color keyed for easy fast sortation, and assembled for easy knockdown, may be allowed given the very short lifetime of toys. There will definitely be more metal and durable glass-glass composite toys.

While we have made great strides through electronics towards a paperless society, that goal is still far off - we now consume more paper than ever. Crude craft papers may be made available for children's art purposes, since these items can usually be recycled fairly quickly. Other organic materials, flour and dough clays, corn husks, seeds, etc. should also be available for "art du jour."

In contrast, serious art will have to rely on inorganic lunar-sourceable media: art glass, ceramics and ceramic glazes, metal, and crude paints made of metal oxide pigments in a suspension of sodium silicate "waterglass", an art form we have personally tried with some success.

These material strictures coming from the Moon's have and have not dual chemical personality, will also affect import policy. Imports of items made of elements already abundant on the Moon may be discouraged - why import coal to Newcastle? On the other hand, imports of scarce elements may be preferred by tax policy. However, such imports will be tightly steered towards on the Moon uses for which they are in most dire need.

The upshot is that the material side of lunar culture will have a very different and distinctive look and feel from the very outset. It may take getting used to, but we think future Lunans will be proud of their success.



"Mother Earth" - of course! - But "Mother Moon"?

Earth's Atmosphere ↑

The Moon's Regolith layer ↓

2 distinct, yet analogous types of

"CRADLE BLANKET"

by Peter Kokh

On Earth we live on the interface of a land-sea surface and a generous atmosphere. At the bottom of this gaseous ocean, temperatures are greatly moderated, and most of the life-frying radiation that permeates outer space is filtered out - in particular solar ultraviolet and the high energy particles of solar flare storms. The atmosphere serves as a protective "cradle blanket" for life on Earth.

Much has been made of the absence of such cradle blankets on other worlds in the solar system. Venus' atmosphere is crushingly thick, with a surface pressure some 90 times that to which we are accustomed. What's more, it is extremely hot, sulfurous, and unbreathable.

Mars' thin atmosphere is enough to support wispy clouds and occasional dust storms, but does a poor job of insulating the surface and filtering out harmful ultraviolet. On the plus side, it is thick enough to allow fuel-saving aerobrake landing maneuvers, even thick enough to allow for aviation to become a major avenue of transportation in the opening of the planet's extensive frontier, equivalent to the land area of all Earth's continents. Yet for thermal insulation purposes and UV protection, Mars is functionally as airless as the Moon.

On the Moon and Mars, we will have to live in tightly pressurized habitats, and protect them with thermal insulation and radiation absorbing mass - either in the form of a piled up overburden of loose surface material or by placing our habitat structures in handy subsurface voids like lavatubes.

Fortunately, on both worlds, meteorite bombardment through the ages has built up a convenient surface layer a few meters thick of pre-pulverized material that is readily available for this purpose. This layer is called the "regolith" [Greek for blanket of rock]. Largely rock powder, it contains larger rock fragments and a considerable amount of tiny glassy globs that have resulted from the heat of meteorite bombardments.

While lunar regolith occupies the same physical site as topsoil on Earth, there is an enormous difference. Earth's topsoil is principally derived from wind and water erosion, which leaves the particles rounded, not rough and angular like the "unweathered" grains in moon dust. Terrestrial topsoils have varying but significant components of hydrates (water-bonded minerals) and of carbon-rich organics (decomposed plant and animal matter). They are also rich in nitrates.

Nor on the other extreme, can regolith be compared to relatively inert beach or desert sands. Sands are mostly silica, silicon dioxide. Lunar regolith is metal-rich in comparison.

In essence, we have to burrow under this rock powder surface blanket. We will live and operate largely not "on" the visible surface at all, but once again on an "interface", this time between the fractured bedrock substrate and the powdery moondust top layer. Just as on Earth, we will survive and learn to thrive "tucked under a blanket" that provides thermal insulation and UV/Cosmic Ray/Solar Flare protection.

The regolith promises more than that. Its pulverized state makes it a handy and ample pre-mined endowment of the Moon's mineral resources. Lunar industrial development will build on this ready resource. More, having lain on the surface for eons, the regolith has soaked up incoming solar wind particles like a sponge. So it offers us gaseous wealth as well.

For thermal and radiation shielding, regolith can be blown, dumped, or bulldozed over our habitat structures. We can put it in bags to use for the same purpose but with greater convenience. Vibration compacted and then sintered by concentrated solar heat, it becomes a low performance solid ("lunacrete") that can be used for paving or as blocks for constructed unpressurized outbuildings, or for decorative interior walls. Flocking regolith on molten glass as it is shaped, or on ceramic greenware before firing may make for an interesting artistic effect. Sifted free of the more finely powdered grains, it may make a suitable soil or rooting medium for both geponics and hydroponics food production.

Finally, regolith will "give up" some of its valuable

elements *very easily*. Pass over it with a magnet to extract all the pure unoxidized iron particles (“fines”). Apply heat and extract all the adsorbed Solar Wind gasses: hydrogen, helium, carbon, nitrogen, neon, argon, xenon, krypton. Other elements (oxygen, silicon, aluminum, magnesium, calcium, and titanium and other alloying ingredients) can be extracted with more difficulty through a number of known processes.

Regolith seems a strange name. Pioneers may shorten it to **‘lith** (‘lith shielding, ‘lith-scaping, ‘lith-moving equipment, etc.) By whatever name, it will play *the major role* in shaping lunar civilization *and culture*. For moon dust is another very different yet analogous kind of cradle blanket. It will effectively tuck us in, motheringly, on the Moon. 

A tale of 2 Moons

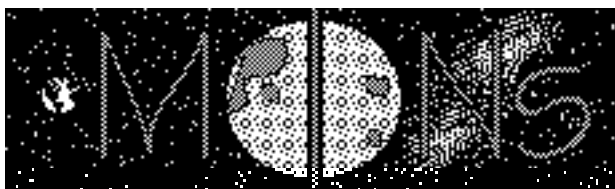

Earth-facing & Earth-oblivious

by Peter Kokh

Relevant Readings from Back Issues of MMM

[MMM Classics #1]

MMM # 9 OCT '87, “Farside: Part I”

MMM # 10 NOV '87, “Farside: Part II”

[MMM Classics #7]

MMM # 69 OCT '93, p 7 “Seven Wonders of the Moon”

[MMM Classics #9]

MMM # 86 JUN '95, p 8 “Relayside”

The fact that the Moon keeps the same hemisphere forever turned toward Earth, while the other hemisphere is forever averted from Earth, may well have profound effects on Lunan culture, markedly distinguishing Nearside and Farside folk from each other. Much that applies to Nearside applies to Farside equally (mineral character of the surface, airlessness and exposure to cosmic weather, low gravity, thermal extremes, general dehydration, etc.) It is life against these constraints that will shape the Lunan character in general. But the presence or absence of Earth over the horizon will introduce profound differences in the cultural spirit of Nearsiders and Farsiders.

Nearside: Earth hangs in the black star-filled sky like some bedazzling jewel filling thirteen times the sky area with some sixty times the candlepower the Moon in our own skies, phase for phase. Its ever re-marbling blues, greens, tans, and whites will make it the prime repository of color in lunar “nature”. Paradoxically, where the Earth is at a very high angle over the horizon in central Nearside (the “Crooknecks”), it will be less obtrusive into daily consciousness than closer to the Nearside limbs where it hangs comfortably above the horizon (the “Postcardlands”). Many Nearside homes, offices, schools, hotels etc. will have windows built to frame the ever changing and ever fascinating spectacle of Earth.

It is, of course, possible to look at Earth, even study it

from the Moon, just for its beauty and everchanging detail - without being reminded of the human culture on its surface, and its overwhelming dominance of the Earth/Moon economic equation. Some pioneers will be more successful than others in resisting the intimidation of the spectacle. Others, feeling Earth’s presence as overbearing, will work the harder to develop genuinely Lunan forms of culture and expression.

Again, paradoxically, the presence of the Earth may insert itself most strongly right along the limbs of Nearside where libration effects sometimes let it slip just below the horizon (the “Peekaboos”). Here in a broad 14 degree swath around the Moon from pole to pole where Earth oscillates above and below the horizon on a four week cycle, there may arise major settlements involved in the construction and maintenance of lunar solar power arrays beaming electrical power Earthwards - as well as a scattering of resorts. For the Peekaboos in general may become a favorite Lunan honey-moon destination. Here one can experience alternately, Earth kissing the horizon, and the rapture of Earthless skies.

Farside: Beyond the limbs (the “Peekaboos”), Earth is out of sight and out of mind. Lunar Farside is rather turned towards the “rest of the universe, a universe without Earth”. Its skies instead are dominated by the unchallenged splendor of the Milky Way in a glory not yet fully experienced by any human (excepting brief out-the-porthole glimpses by busy Apollo astronauts circumnavigating the globe).

Not only will Earth be visually out of sight, without cable relay to Nearside, or without satellite relays, the home planet will be out of sight electronically as well. The resulting “silence” will be an invaluable asset to radio astronomers attempting to listen to the whispers of the universe in order to learn more about its structure, and whether or not it harbors other contemporary and equally curious techno-sapient species.

Terrain-wise, Farside has great impact basins just as Nearside does. But because the Farside crust is much thicker, the molten magma from the interior has had less success in reaching the surface and pooling in great sheets within these basins - to make “maria”. Farside “seas” are smaller and scattered in comparison. There is no convenient “chain of seas” as on Nearside, making long excursions much more difficult. Farside terrain will be more of a challenge to builders of global highway networks.

Pioneers will come to Farside not only in the support of scientific installations like radio astronomy arrays, but for mineral resources that may conceivably occur there in richer concentrations than on Nearside. For whatever reason, over time, Earth being out of sight, out of mind, Farsider culture will evolve as more fiercely self-reliant, more willing to cut umbilical ties to Earth, more fascinated with the greater universe out there, more enraptured by the siren call of the stars.

If we do someday succeed in establishing self-reliant but interdependent pockets of humanity beyond Earth orbit, to the point where some sort of “consolar” organization or association seems called for, a site on the lunar Farside might command top consideration for a headquarters or solar capital. Lunar Farside is conveniently close to Earth in travel and communications terms - and - the vast bulk of humanity will remain on Earth for the foreseeable future. Yet lunar Farside

will be a place preoccupied with “the rest of the universe”, a place unintimidated by Earth and its massive civilization and economy. In contrast, Earth will be very much present in the skies of Martian settlements, shining almost Venus-bright.

Any particular favorite sites? It would seem the best site for an extensive radio astronomy installation would be in Thomson crater in the north east of Mare Ingenii, the Sea of Ingenuity. A solar “capital” could piggyback on such an installation. But seen from approaching spaceships, easily the most visually striking feature of lunar Farside is the very dark mare-filled floor of the great crater Tsiolkovsky, dominated by the very bright central massif, the peaks of Konstantin. Such a site would have much romantic appeal and the symbolism of the name could not be more serendipitously propitious.

It will take time, of course, for cultural differences between longtime Nearsiders and longtime Farsiders to appear. Once they do, the differences might become the stuff of friendly rivalry. Yet the much broader shared conditions of life on the Moon will dominate both cultures in the end. 

the



revisited

How Lunans will mark the days

by Peter Kokh

Relevant Readings from Back Issues of MMM

[Republished in MMM Classics #1]

MMM # 7 JUL '87, “Essays in ‘M’: Month, Meridian, Metonic Period”; “Moon Calendar”

[Republished in MMM Classics #5]

MMM # 43 MAR '91, pp 4-6 “Dayspan”; “Nightspan”; “Sunth”

[All MMM articles on this subject through MMM #150 are collected online at:

www.lunar-reclamation.org/papers/mooncalendar_paper.htm

In our attempt to uncover the early roots of a distinctively Lunan culture, we have looked at the Moon’s “sixth-weight” gravity, its airlessness and exposure to the cosmic elements, the natural quarantine it imposes between scattered settlements, its dehydrated state, and its mixed bag of mineral assets. All of these will radically affect the development of Lunan civilization and culture from day one.

But there is yet another brute physical fact about the Moon that will affect everything just as deeply: the slow lethargic crawl of the Sun across the sky - the Moon’s 14.75 day long “dayspans” and “nightspans”, its 29.5 day “sunth”.

[Astronomers call the period from full (or new) moon to full (or new) moon a “lunation”. From a lunar point of view, what is important is the sunrise to sunrise period. It would be silly for them to call it a “month”. An “Earth” (full to full or new to new) would make sense only to Nearsiders. So we suggest the “sunth” as *the* logical term.]

While within habitats and biospheres lighting can be artificially controlled to reproduce the Earth-normal 24 hour lighting cycle, much of lunar industry will have to match the rhythm of its operations to that of the sunth. For even if we have nuclear power to sustain a higher level of nightspan industrial activity, the availability of abundant free solar power during dayspan, will mean that there will always be a premium on getting done as much energy-intensive work as possible during sun-up, preferentially leaving energy-light, labor-intensive tasks for nightspan - where possible. This mode of operations will create a strong fortnightly rhythm in many sectors of Lunan life. [see “Dayspan”, “Nightspan” ref. above.]

Pioneers will be free to use Earth’s calendar, its days, dates, and months to govern their lives. Certainly Lunan astronomers and businessmen involved in export-import trade may need to do so. Those addicted to regular TV programs relayed live from Earth, and new settlers not yet committed to a lifetime stay may do the same. But for most Lunans, Earth’s rhythms will be totally irrelevant. “The” thing that will matter above all is the timing of local sunrise and local sunset.

One way to harmonize the rhythms of their lives to those of the Moon would be to start with an all new Calendar, designed from scratch to better serve their purposes. If Lunans adopt a system of alternating 29 and 30 (24 hour) date sunths in which each sunth always begins on the same day of the week, then at each location on the Moon, sunrise and sunset would always fall on the same dates of the sunth. This would favor smooth production scheduling and a rhythm to count on.

The only way to do this, however, would be to insert an 8th day, 3 weeks out of eight, yielding 4 weeks exactly each sunth, alternately 29 and 30 dates long. There is a catch. This immediately uncouples Lunar weekday names from those in use on Earth. The eighth day could be inserted in a weekend, allowing for convenient holiday and festivity scheduling with no interruption to the work week, and should be a popular feature. But it is something sure to scare the pajamas off the various warring clans of Friday, Saturday, and Sunday fundamentalists, all of whom seem to think Earth’s weekday sequence is an immutable, transcendental, cosmic law. Indeed, in the past, no proposal for calendar reform has been more certain to fail than a change in the Sunday-Saturday sequence.

For the sake of argument, let us assume that our pioneers are of the mind that this is a brand new world, and fresh beginnings are in order. They opt for the 24 hour date, the 7-8 day week, and the 4 week Sunth. The first of each calendar sunth would coincide with the “Full Earth” as seen from lunar Nearside (this occurs simultaneously with the “new moon” as seen from Earth). Nearsiders will have sunrise in the first half of the sunth, sunset in the second. Farsiders will have sunrise in the second half of the sunth, sunset in the first.

[A detail: because the sunth is 29.5306 days long, not 29.5 exactly, every 40th date, or on the closest weekend thereto, an extra hour would be added (as we do in the fall, switching back from daylight savings to standard time). This measure would keep the 29-30-29-30 pattern accurate - at the price of Earth dates lapping lunar dates by one every 2 1/2 years.]

Next, they will need new names for the days of the week, since their matchup with Earth’s weekdays will always

be ratcheting backwards with every 8th day insertion, 3 times every two sunths. Using the old names would mean utter confusion. Here are three name set suggestions:

(1) the names of the 7(8) biggest moons in the solar system:

Luna, Io, Europa, Ganymede, Callisto, Titan, Triton, (Titania)

(2) the names of the 7(8) stars in the Big Dipper: Dubhe, Merak, Phad, Megrez, Alioth, Mizar, Alkaid, (Alcor). The problem with this suggestion is that the Big Dipper is not visible below latitude 30° south on the Moon and some southern settlements would thus find these names elitist.

(3) [this suggestion is the one this writer personally prefers] the names of the 7(8) stars of the Pleiades star cluster (and the attendants of Artemis, a Greek mythological moon goddess): **Alcyone, Celaeno, Electra, Maia, Merope, Sterope, Taygeta, (Pleione and/or Atlas**, the parents of the seven sisters). Pleione could be used for the 8th day inserted in the mid-sunth weekend, Atlas for the 8th day inserted in every other sunth-end weekend. The Pleiades can be seen from all locations on the Moon as they cross the sky above the lunar equator. The 7-8 date week, again to avoid confusion with the invariable 7 day period of Earth, could be called the **Pleiad**.

Time zones?

On the Moon, the Sun rises an hour earlier every 9.5 miles you travel to the east, and that's at the equator, in a shorter distance closer to the poles. There is a 24 hour difference every 12.2° or every 230 miles along the equator. It will be much simpler for all the Moon to have just one time zone.

The fun has just begun. The Sunth-Pleiad solution is the easy part. Those of you figuring ahead must have realized that 12 sunths = 354+ days, 11 less than an Earth standard year.

This has always been the problem with counting by moons, instead of idealized 30-31 day calendar months. On Earth, while the period between full moons or new moons is a handy yardstick, the one thing that really matters above all is the succession of seasons in a 365 day cadence. It is the Solar year, not the lunar year that is king. Two cultural traditions, Jewish and Islamic, have adopted lunar calendars nonetheless.

The Jewish calendar attempts to keep step with the solar year by adding a thirteenth intercalary month, seven years out of nineteen. [There are 235 lunar months *exactly* in 19 calendar years of 228 calendar months. This is called the Metonic Period.] The Moslems make no attempt to keep pace and end up counting 33 of their years to every 32 of ours (the time it takes the faster 354 day year to lap the slower 365 day).

On the Moon, Earth's seasons by which weather governs agriculture, are of no real concern. Lunar agriculture, in controlled biospheres, can set its own seasons, and will be more sensitive to the availability of free sunlight on a sunthly schedule of two weeks on, two weeks off. Nonetheless, there will be incentives to keep the lunar sunth year and terrestrial solar years in step, at least over the long haul. The Moon, unlike Mars, is in Earth's backyard, and the sheer volume of live communications, and the heavy regular traffic in exports and imports make Earth's dominant calendar something not to ignore lightly.

This said, are there any solutions better than the two mentioned above? The problem with the Jewish solution of

twelve 354 day years of 12 lunar months interspersed with seven 383-4 day years of 13 lunar months is that the years are very unequal, a severe handicap for fiscal accounting and economic management. The Islamic solution is to ignore the problem and not make any attempt at concordance.

Option A

One possible but radical synthesis is a Metonic Period sequence of 19 years of 12 lunar months (sunths) of 354 days each, followed by a once-a-generation cultural, social, and institutional renaissance period of 7 "catch up" lunar months (sunths), at the end of which, the lunar and Earth calendars would again be in step. This would provide equal years for accounting purposes, and the cultural, social, artistic, institutional renewal once a generation would be planned, anticipated, and provide a culturally treasured shot-in-the-arm. There are problems with this: how do you count anniversaries, especially for events taking place in the 7 renaissance sunths?

Option B

Perhaps an even more radical solution is to uncouple the sunth-sequence from the year. We already have a calendar in which the weekdays are uncoupled from the days of the month. That is, January 1st can fall on any day of the week. Months begin in midweek (Mon. thru Sat.) six times out of seven. We could have a sequence of 235 sunths (repeating every 19 years) and allow the Calendar Year or New Years Day to float through the sunths, much as we allow the "First" to float through the week. The sunths could simply be numbered 1 through 235 instead of named. Or, easier to sell, there could be a sequence of 12 names with a thirteenth intercalary sunth 7 years out of 19, Jewish style. A floating New Years Day would keep the terrestrial year counting cadence, while still coupling lunar life to the dayspan-nightspan pace of the sunth.

One could hardly fault Jews for suggesting the wholesale adoption of their lunar calendar complete with the names they have used for the lunar months for thousands of years. For a probably pluralist lunar society, this may not be a diplomatic solution. New neutral sunth names may be in order. Might we suggest something simple: (u in sun is unaccented) Firstsun, Secondsun, Thirdsun, Fourthsun, Fifthsun, Sixthsun, Seventhsun, Eighthsun, Ninthsun, Tenthsun, Eleventhun, Twelvethsun, (Leapsun)

Firstsun would begin with the *last* (if there are two) new moon (full Earth) in December. In case of two new moons (full Earths), the first would mark the beginning of Leapsun. In either case New years Day, January 1st on Earth, would fall somewhere between Firstsun 1 and Firstsun 29 on the Moon.

Option C

Yet another possible solution would be to have 12 sunths plus 11 extra *year end reset days* so that all sunths of any given year would have the having the same date/day sunrise-sunset pattern, which would be different from year to year in a pattern cycle that repeats every 19 years (the Metonic Period again). This solution would allow a set conversion to terrestrial dates and allow easy tracking of anniversaries. Because each of the 19 years of the sequence would have a characteristic pattern, they might be named, much as in the totemic Chinese system (year of the dog, of the pig, etc.).

There are two additional benefit of this system: the introduction of variety (the same variety we experience by important dates falling on different days of the week, year after year); and “fairness”, if you will. By options A and B, some settlements would always experience sunrise and sunset on their weekends, (some on 3 day weekends!) others somewhere during the week. As industrial operations have to shift gear at these two times, the timing will come with different inconveniences during weekends than during the week.

The Lunan settlers themselves must consider the merits of the various proposals above and choose one, or come up with something different. *Please feel free to “vote” for the solution you like best, or to propose another.*

Whatever calendar arrangement settlers eventually choose, it is sure to reverberate throughout Lunan culture, adding yet another layer of distinctive and characteristic difference from the variegated “family” of cultures on Earth.

Physical Calendars

Lunar calendars need to be “perpetual” or recyclable. Options A and B allow a simple two sunth calendar (the 29, 30 date rotation) to be used indefinitely. A movable accent bar over a list of sunths on the side or above would be all that was needed to make it complete. If the day / date squares were reversible tiles, one side the photo-negative of the other, then each calendar could be customized easily to the local sunrise / sunset (dayspan / nightspan) pattern. Materials available are glass, ceramic, and metal. Recyclable organic *art du jour* could take the place of the “scene of the month” on our own paper calendars. It will be interesting. 

Lunar Aluminum and Oxygen Propellants to Support Lunar Bases & Planetary Flight

by Larry Jay Friesen

[A companion paper, “Lagrange Point Staging for Lunar and Planetary Flight” appeared in last month’s MMM.]

Introduction

It will greatly ease the long-term economics of supporting a lunar base to produce propellants at the Moon. These would be used for flights between the lunar surface and any near-Moon space stations, and from there back to Earth. It has even been proposed to supply lunar propellants to low Earth orbit (LEO) to be used for Moonbound ships. This will come as no surprise to long-term students of lunar base proposals. The major reason is that traffic models for lunar base show that by far the largest budget item in mass being moved around between the Earth and Moon is rocket propellant.

Lunar propellant could also be used to launch *inter-planetary* space flights. This would be especially advantageous if those flights were launched from a near Moon staging base, such as the L1 Lagrange point space station proposed in the preceding article [MMM #94, April ‘96]. I am going to argue that the combination of an L1 base and lunar propellants would make a powerfully synergistic combination for supporting both lunar and interplanetary ventures.

The most frequently proposed lunar-derived propellant is liquid oxygen extracted from the oxides and silicates that make up lunar rocks. This would be burned with hydrogen provided from Earth. One attraction of this is that the oxygen/ hydrogen combination provides one of the highest specific impulse values available from chemical propellants. Specific impulse is a performance measure for rockets somewhat analogous to miles per gallon. It is often given in units of seconds, meaning the number of seconds that one pound of propellant could produce one pound of thrust, before it is consumed. The few combinations known that produce higher specific impulse: (a) produce only slightly higher, not grossly higher, specific impulse; (b) are composed of more expensive materials; and (c) are more corrosive and difficult to handle.

One disadvantage of this, if one is trying to minimize mass lifted from Earth, is that the hydrogen will probably still have to be supplied from Earth. Hydrogen is extremely rare on the Moon [Ed. in general. We can hope that Lunar Prospector will confirm indirect indications from the Clementine mission that there is economically significant ice in the permashade areas at the lunar south pole. We should know by early ‘98, latest.] A minute amount is found implanted in lunar soil by the solar wind. It is conceivable that this can be extracted in amounts adequate for life support. However, the amounts of material that would have to be processed to extract enough hydrogen to support a reasonable amount of traffic to and from the Moon are far larger than I, for one, would find attractive.

Other propellant combinations based on lunar materials have been proposed. Silanes would stretch the terrestrial hydrogen by combining it with lunar silicon to make compounds analogous to methane and ethane. This would increase the proportion of the [total] propellant [combination] supplied from the Moon. However, it would also reduce specific impulse. Specific impulses of silanes burned with oxygen are roughly similar to those of hydrocarbons burned with oxygen, or in the range of 300+ seconds rather than the 400+ seconds of hydrogen and oxygen.

Advantages of Lunar Oxygen & Aluminum Together

A particularly appealing propellant combination is lunar oxygen plus lunar metals, especially lunar oxygen and lunar aluminum. Aluminum and oxygen alone will provide a specific impulse somewhat lower than most hydrocarbons. Brower *et al.* expect a value of 285 seconds [1]. However, this should be quite adequate for lunar landing, lunar liftoff, and departure for Earth from an L1 station using a lunar swingby trajectory. Lunar escape velocity is only 2.4 km/sec, so we don’t *need* an enormous specific impulse for operations in the lunar vicinity. A big advantage of this propellant combination is that no terrestrial material at all is required. Keeping down the mass we have to lift from Earth is likely to be a major factor in keeping down the operational costs of our missions.

One means of enhancing the performance of lunar oxygen and aluminum could be to combine them with terrestrial hydrogen in a tripropellant engine. Andrew Hall Cutler [2] estimates that [with] an H:O:Al mass ratio of 1:3:3, such an engine would have a specific impulse exceeding 400 seconds - only slightly poorer than hydrogen and oxygen alone. This ratio also manages to decrease slightly the proportion of

hydrogen that has to be brought from Earth, compared to the approximately 1:5 combustion mass ratio of H:O for Shuttle main engine technology. Brower *et al.* [1] expect that with an H:Al:O mass ratio of 1:2.5:2.75, a specific impulse of 475 seconds can be achieved. This would increase performance, but at the cost of bringing more hydrogen from Earth.

It might turn out that, for instance, lunar aluminum and oxygen alone would be best for a lunar lander flying back and forth between the lunar surface and an L1 staging base, while lunar aluminum and oxygen combined with terrestrial hydrogen would be more advantageous for a space-to-space lunar transfer vehicle (LTV) flying between the L1 station and LEO. Trade studies are needed to decide for what flight phases is most advantageous (i.e. what minimizes mass launched from Earth) to use lunar aluminum and oxygen alone, and when it is best to add terrestrial hydrogen. How *much* hydrogen should be added to the propellant mix, weighing the cost of mass launch against performance gain?

It would also be worth doing trade studies to answer the question: would it be advantageous to ship lunar aluminum and oxygen propellants to LEO? When the overall mass flow in the system is considered, will that reduce mass launched from Earth? Further, would aerobraking for LTV return to LEO be useful in a transportation scheme making heavy use of lunar propellants? Or would the propellant used in hauling the aerobrake around exceed that saved when braking into LEO?

If one wants to extract aluminum as well as oxygen from lunar materials, it means reexamining the extraction techniques. Reduction of ilmenite, for example, an often cited approach, will not do. Ilmenite reduction starts with a[n iron and] titanium-rich mineral found in lunar mare soil and produces oxygen, but no aluminum. Other oxygen extraction methods that do not produce aluminum will not do, either, at least not without steps added to get aluminum metal.

This also means carefully considering *where* on the Moon to go for raw material. Lunar maria are high in iron and titanium, but tend to run low in aluminum, only around 7%. The highlands, in contrast, are rich in an aluminum-rich material called anorthosite, and highland soil tends to be about 13% aluminum by weight [1]. If aluminum and oxygen are both target materials, the lunar highlands are the better place to go for feedstock. [Editor's qualifying comment follows article.]

Lunar Propellants for Interplanetary Flights

Lunar derived oxygen and aluminum propellants could also be used to aid the departure of interplanetary space flights, if those flights were launched from an L1 base on gravity slingshot trajectories as described in the preceding paper [3] [MMM # 94, April '96] If a "triple thrust" departure is used to go to Mars, for example, using both a lunar and an Earth flyby, the total velocity change or delta V (ΔV) needed to depart the lunar vicinity is only 350 meters [0.35 km] per second. ΔV gives a measure of the amount of energy and propellant needed to accomplish a maneuver, if you know the performance of the propellant combination your ship is using. The additional ΔV needed at perigee to place the ship in Mars-bound trajectory is only 790 meters [0.79 km] per second.

It is quite conceivable that lunar settlers may one day produce oxygen and aluminum propellants for departure stages

of planet-bound spacecraft, maybe with Earth hydrogen added for extra performance. Lunar oxygen could well fill the oxidizer tanks of the interplanetary craft for the subsequent maneuvers in its itinerary. If the interplanetary ship designers select a tripropellant propulsion system, the ships may carry lunar aluminum as well, with only a small admixture of terrestrial hydrogen to boost specific impulse. Using lunar propellants along with launching and retrieving interplanetary flights at L1 [3] could significantly reduce costs of interplanetary travel.

Ways to Implement Lunar Aluminum/Oxygen Propellant Usage

How are we to implement the use of lunar oxygen and aluminum propellants together? One way would be to pump aluminum powder as we do fluids. In this case, it will probably be necessary to use a carrier gas along with the powder to keep the aluminum grains from vacuum welding or sticking together from electrostatic forces. Here we could use lunar hydrogen implanted in soil grains by solar wind, because only a small amount is needed. The hydrogen for this function does not have to be a significant fraction of the propellant.

Another technique is a hybrid rocket engine using solid aluminum and liquid oxygen. A conceptual design for such an engine was proposed by Brower *et al.* [1]. Their design calls for a hexagonal array of aluminum bars the length of the combustion chamber. Liquid oxygen would be fed down the bars for regenerative cooling before reaching the flame at the bar tips. The engine could use oxygen and aluminum only, or could use tripropellant operation with hydrogen.

References

- [1] Brower, D., Adams, T. Kelly, C. Ewing, and T. Wiersema, "Conceptual Design of Hybrid Rocket Engines Utilizing Lunar-derived Propellant", AIAA paper 90-2114, delivered at AIAA/SAE/ASME/ASEE 26th Joint Propulsion Conference, Orlando, FL, (July 16-18, 1990).
 - [2] Cutler, Andrew Hall. "Aluminum Fueled Space Engines for Economical Lunar Transportation". *Lunar Bases and Space Activities of the 21st Century*, W.W. Mendell, ed., Lunar and Planetary Institute, Houston, (1985) p. 61.
 - [3] Friesen, Larry Jay, "Lagrange Point Staging for Lunar and Planetary Flight", *Moon Miners' Manifesto*, issue # 94. April 1996, Milwaukee, WI. [Above, this MMM Classics #] **LJF**
- [EDITOR'S COMMENT: We thank Larry Jay Friesen for this excellent and enlightening pair of papers. However, Friesen's remarks on lunar base siting call for comment.

Those who do not foresee (or do not wish to speak to) the industrialization of the Moon, and are only trying to brainstorm the economics of renewed exploration activities, may indulge in the thought that efficient oxygen production is the only determinant of consequence when it comes to picking a site for a lunar base. But those of us who look forward to real, industrially self-supporting communities on the Moon must take a wider view. Lunar settlers will need access to all economically producible elements. *From a lunar development point of view it is clear that we ought to put our outpost in a location from which both suites of materials (aluminum rich highlands, iron rich maria) can be accessed with equal ease - highland-mare "coasts!"* This solution is *so self-manifest* that the very continuance of this debate exasperates! Those who come from different disciplines must talk to one another! **PK**

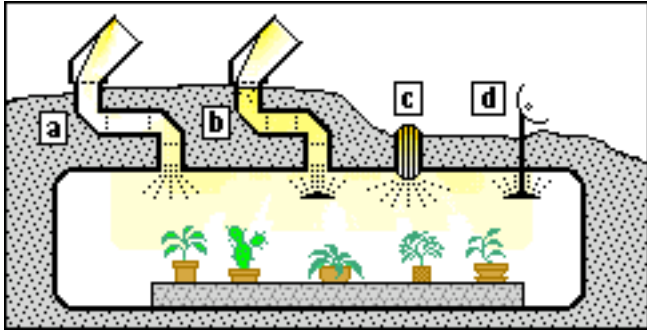

A Green Security Blanket

How will outpost personnel on the Moon for long tours of duty, and eventually Lunan settlers intending to live out the rest of their lives, cope psychologically with the unending and unrelieved stark and barren moonscapes? Whether traveling on the surface or looking out a habitat view port, they will never spot a stitch of chlorophyll green, of plant life, not even as humble as moss or lichen or slime. We can expect that they will compensate with an unusual abundance of house plants - by our standards. See *below*.

[Continuing a New MMM Series]

in the (new) beginning, ...
(Starting over on the Moon)

The primitive roots of "Lunan" Culture, III

Last month we talked about the deep effects on Lunan Settler culture of the Lunar Global Desert, the Moon's mixed bag of abundant and scarce elements, the lunar regolith as a type of "Cradle Blanket", culture-salient differences between lunar Nearside and Farside, and the effect on culture of the dominant 29-30 day long dayspan/nightspace cycle through a distinctively homegrown "moon calendar"

This month we continue our story with culturally relevant corollaries of the Moon's airless and sterile environment, probable rejection of the "spacesuit" as a daily fact of life, and the premium on habitable pressurized space. The bare raw facts of lunar life have yet more to tell us about the outlines of future Lunan culture, and we'll continue where we leave off, next month. Read, enjoy, and stay tuned. MMM

*We shall not cease from exploration
 And the end of all our exploring
 Will be to arrive where we started
 And know the place for the first time.*

T. S. Eliot in "Four Quartets"

The Unending Vigilance for

Fresh Air

"Mini-biospherians will live just downwind and downstream of themselves."

"You can't just open the window and let in some outside fresh air."

"We can't go if we can't breathe."

by Peter Kokh

Relevant Readings from Back Issues of MMM

MMM # 36 JUN '90, pp 3-5 "Biospherics", D. Dunlop

MMM # 51 DEC '91, p 3 "Everfresh"; p 4 "Fire Dept."

MMM # 52 FEB '92, p 5 "Dept. of Xity Biosphere"

The sealed window

Most of us hopeful and expectant that humanity will indeed spread off planet, have a very unrealistic idea of the difficulties we will have to overcome if we are in fact to be able to successfully engineer and maintain micro- and mini-biosphere environments that work, and work forgivingly, long term. Here on Earth when the inside air becomes too polluted from the outgassing of organic and synthetic building materials and from the chemical household maintenance products upon which we have become dependent, we have but to open the window and let in the relatively fresher outside air.

Outdoors, when air quality is bad, we know that sooner or later the wind will bring us relief. In space and on the Moon, even on Mars - *anywhere in the solar system* beyond Earth's mothering atmosphere - we will not be able to simply open the window, and there will be no outside winds. We will have to deal with the problem, principally by not allowing bad air situations to arise in the first place.

Outlawed items

Not to burden the air with pollutants that may be hard for many to handle in closed quarters, aromatic substances in general may be proscribed in more than subliminal quantities. Anecdotally, this will mean relying on honest hygiene as opposed to masking colognes and perfumes. Even in very small doses, in closed environments where there is no inside-outside air exchange, consciously detectable fragrances may become oppressively suffocating to many.

All materials outgas, synthetic materials especially so. Fortunately on the Moon, there will be little use of such materials for economic reasons. They can't be produced from locally available material stuffs, and importing them, or their stuffs, will be prohibitively expensive. This will make lunar habitat space much cleaner than most terrestrial interiors from the gitgo. But that's only the start.

Cooking odors, as much as we love them (save for chitterlings), can also become oppressive when there is no air exchange with the outdoors. Open boiling and frying may be verboten. Microwave and pressure cooker food preparation may be the way to go. If you're on the ball, you just realized this means no more "backyard" or patio barbecues. Restaurants with autonomous closed loop air circulation systems may be permitted an exemption. The cost of such equipment will be

reflected in the price of those ribs and steaks, however (as if the cost of importing such meats wouldn't be pricey enough).

The “middoors” - fresh air faucet and stale air sink

Once we begin to construct settlements properly speaking, pressurized spaces will begin to sort out into relatively volume-restricted interiors of private quarters, offices, shops, etc. and the relatively volume-generous pressurized common spaces of streets, alleys, parks, and other commons, on to which the “indoor” spaces open. These pressurized all-interconnecting commons we have dubbed the “middoors”. There will be air-exchange between “indoor” and “middoor” spaces, all within the continuous settlement mini-biosphere. That will be the source of some relief.

To make the middoors system work as both fresh air faucet and stale air sink, there will have to be a xity plan [“xity”, pronounced *ksity*, is an MMM-introduced word for an off-Earth (i.e. the x is for exo) community that has to provide its own biosphere, something no city on Earth has to do] that carefully arranges farming, residential, commercial, and industrial areas so as to create an air circulation loop cycling probably in that very order and back again. All mini-biospherians will essentially be living downwind and downstream of themselves, and this area zoning will provide the only limited buffering possible.

How do we do this and still allow for urban growth? The answer may lie in a cellular xity plan, in which each neighborhood has its own locally balanced area zoning and air quality restoring circulation. One happy result of such an integral neighborhood by integral neighborhood (or urbicell) plan is the millennia-overdue reintegration of city and farm, a restoration of the healthier pattern of farming villages. In the xity, as opposed to the city, vegetation will once again host humans, not humans hosting mere token house plants and landscaping accessorizers. (See the following article.)

In addition to the zoning pattern, there will have to be active ventilation and circulation assists in the form of fans. Air circulation need not be strong, nor steady except in an averaged sense. A certain randomizing of velocity and vector can simulate the pattern of natural breezes.

Part of this air circulation / freshness regeneration loop will be humidification in the agricultural areas, with fresh drinkable water coming from dehumidifiers elsewhere. Using water reserves in later stages of treatment for plant misting, water fountains, and waterfalls, will help control dusting and provide pleasant just-after-it-rains air freshness. Negative ion boosters can also be used here and there.

Fire and Smoke

As we learned from Skylab experiments in 1974, fires in orbiting spacecraft spread only one-tenth to one-half as fast as they do on Earth, *provided there is no fan-assisted ventilation*. On Earth, hot, thus lighter, combustion gases flow upward, and fresh, oxygen-rich air is pulled in to replace them, fueling the fire. In free fall space, there is no 'up', and no buoyancy effect. On the Moon, in still air, spread of fire by convection will be slowed, but still a factor, and fan-assisted ventilation is a certainty.

Far more important in all off Earth situations is the fact that we are dealing with sealed micro-environments. There

is no fresh air reservoir “outdoors” and we cannot “open the window” to let out the smoke. While the flip side is that habitat fires will inevitably extinguish themselves through oxygen starvation, this will only occur long after they have resulted in very final casualties wiping out all unlucky enough to be present. In short fire cannot be tolerated, cannot be allowed to happen.

Fortunately, in lunar mini-biosphere environments, we will see extremely limited “gratuitous use” of combustible materials, other than for next-to-skin clothing. Furniture and furnishings as well as building materials will be all but exclusively inorganic and incombustible.

On Mars, that need not be the case, and so fire there could be a much more real danger. Possibly, through the Lunar experience, we will have become sufficiently weaned of the organic stuffs (wood, paper, plastics, foams, fabrics) so easy to provide in the macro-biosphere of Earth, that even though the volatiles-rich environment of Mars will support their reintroduction and our re-addiction, Martian pioneers may choose to forgo these temptations, living much as Lunans do.

Questions in search of answers

The Biosphere II experience gave us some answers to questions we didn't suspect existed, and even more importantly showed us the extent of our ignorance. There were problems maintaining the proper percentages of both oxygen (too little) and carbon dioxide (too much). We discovered some building materials (e.g. concrete) to be oxygen sinks.

Off planet, we don't even know yet what nitrogen oxygen ratio it will be safe to use. Nitrogen may need to be imported, and the less we can get by with the better.

We scarcely know how to build a biologically assisted closed loop air system, much less a principally biologically maintained loop. The Space Station (Mir or Alpha) rely on continual resupply shipments of fresh water and make-up air

A wakeup call

That will be no way to maintain a lunar outpost. Nor will it be a way to support a Mars mission —not on the planet, not even en route, going or returning! In plain fact, had we the money, we could not go. It's not transportation technology that will hold us up, but budgeting and policy failures to support the programs needed to develop closed loop life support systems. Meanwhile hardware jock space enthusiasts ignore the problem like so many ostriches. This attitude and our lack of involvement have to change!

We can't go if we can't breathe. It's as simple as that.

Those who have survived near death experiences tell us that the most horrible way to die is not fire, as I would imagine, but drowning or suffocation - the absolute psychological panic of not being able to draw the next breath. Fresh air is not a luxury, nor just a good idea. We'd better be sure we know how to maintain it. MMM

**“1/6th G —
It's not just a good idea,
It's the law.”**

— Luna City local ordinance

Against the Overwhelming Barrenness of the Moonscape



by Peter Kokh

Relevant Readings from Back Issues of MMM

MMM # 8 SEP '87, "Parkway"; "Animal Life"

MMM # 50 NOV '91, pp 8-9. "Trees"

MMM # 53 MAR '92, p 6 "Xititech III. Cellular Rhythm"

MMM # 54 APR '92, pp 5-6 "Xitiplans"

MMM # 76 JUN '94, p 1 "Windows, in with a new cliché"

Some of us are house plant nuts, some of us are hobby gardening enthusiasts. But perhaps most of us don't give vegetation, indoors or out, much thought. We don't have to. Given the general luxuriant feel of the outdoors, we get enough of a green-fix automatically without having to concern ourselves much about it. And that remains generally true, even in this era in which the health of the host environment is in question, and living nature under siege from selfishness, greed, and simple carelessness.

On the Moon life is not a given. There is none of that comforting green stuff maintaining itself on automatic. The outdoors is lifeless, barren, sterile - relentlessly so - assertively so - threateningly so. Greenery within the protected confines of the mini-biosphere will become a preoccupation of all but the most soulless personalities.

That a healthy abundance of plants contributes significantly and noticeably to air quality and freshness will be a reinforcing motivation. (NASA-funded studies have shown that the right mix of houseplants can be quite effective in reducing household airborne pollutants.) But we suspect that for most Lunans, the real driver will be the need to use plant life as a security blanket, a psychological filter against the out-vac's life-quenching sterility, much as for smokers, a cigarette makes the world a friendlier place (no, I am not one).

If lunar homes and offices and schools have windows affording moonscape views, inside window box planters of houseplants will take the edge off the life=threat of that magnificent but deadly desolation. But we will find many other nooks and crannies to put plants. Greenery and foliage will become the mainstay of interior decoration. Everything else will play but a supporting role.

A much higher percentage of Lunans are likely to be home gardeners. They will be aggressive in finding opportunities to add plants. Quite possibly a solar-lit atrium space will become the organizing focus of choice in purchaser chosen home plans. Such a space will afford vegetable and herb gardens or a mini-orchard to help with the food budget and menu variety, maybe a tad of entrepreneurial canning. But it could also be devoted to purely decorative plantings of variegated foliage and flowering plants, song birds, hummingbirds, and butterflies. Or it could become a more mystical place, a Japanese style sand and stone garden. For despite the

general preoccupation with plant life, there will still be a big range of personal sensitivities, and of lifestyle needs.

Architects in general will look for ways to build-in planters and other cubbyholes for plants, providing also for their illumination. Vegetation will be a new design parameter.

Out in the "middoors" too, every opportunity to tuck in vegetation will be aggressively pursued by architects and users. Middoor streets and passageways, intersections and squares, are likely to become as verdant as they are busy. This can be the concern of the xity administration, or, more healthfully, of rival neighborhood, and street merchant associations, or other stretch-"adopting" clubs.

While green will be the dominant color thus inserted into settlement life (architects and decorators will be motivated to find ways to introduce ambiently lit sky blue ceilings and open space sky blue vaults), settlers may rely on plant life to provide other colors as well. The early lunar art pallet (water-glass-based metal oxide "paints" and ceramics) will be one of generally subdued colors. As helpful as such additions will be, the thirst of the more vivid coloration of flowers (and perhaps birds and butterflies) will be strong.

It is likely that flowering plants will be staggered so that at least something is in bloom every sunth (the lunar dayspan / nightspan cycle). Will flowering plants grow taller on their own in sixthweight? Or can they be coaxed to grow taller? If so, Lunans may be able to savor the delight of floral "forests". These would provide a must-see tourist draw.

Trees are likely to be of the dwarf variety (many fruit-bearing dwarf hybrids are already marketed), more bush-like in size, at least until the cost of imported nitrogen makes economically feasible the construction of higher-vaulted middoor spaces. In the meantime, to fill the void, individuals and clubs may take strongly to the cultivation of bonsai trees, even to the point of growing bonsai forests, again a tourist must see.

The first parks may be interim floral and grassy meadow refuges within agricultural areas. Even if the farm units are highly mechanized assemblages of trays and racks and LED lighting arrays, the sight of so much greenery (and the freshness of the air) will make any kind of food-producing area a mecca for those living or working nearby.

In the previous article, we mentioned that mini-biospheres will guarantee the reintegration of city and farm, the overdue return to farm village roots and a more nature-harmonious lifestyle-paradigm. Already in this century here on Earth, most developed cities have thinned out greatly in density, giving much more space to greenery (even if still more to pavement, in homage to the great god Auto).

Also on Earth, we have seen a general increase in urban and especially suburban wildlife, a welcome turnaround, led by post-human species, species that have learned to thrive in human-dominated environments. We can hope that Lunans will indulge in the luxury (to bean counter eyes) of urban wildlife. We've mentioned birds and butterflies. Surely bees, ducks, swans, flamingos, squirrels, even deer, and more.

In our cities, pockets of life are seen as a concession to nature. In the off planet xity, pockets of humanity will be the concession. Vegetation will play the host. The Xity will be an exercise in symbiosis, man and Gaia reunited. 

Spacesuit Aversion

The quest for alternatives to a user-unfriendly interface

by Peter Kokh

Relevant Readings from Back Issues of MMM

MMM # 5 MAY '87, "M is for Middoors"

MMM # 49 SEP '91, p 4 "Visiting Amphibious Vehicle"

MMM # 53 MAR '92, pp 4-6 "Xity Plans"

MMM # 89 OCT '95, p 6 "Dock-Locks; Buppets"

Bryce Walden, Oregon Moonbase (bwalden@aol.com) writes:

"Sorry I don't have a firm attribution for this. It's a short note I took down while channel-hopping a couple of years ago. The speaker was an astronaut with some experience in a spacesuit, and he listed the "Five Worse Things About A Spacesuit:"

- (1) You can't blow your nose.
- (2) You can't comb your hair.
- (3) You can't read your watch.
- (4) You can't eat regular food.
- (5) You can't scratch an itch.

I suspect that the first and last complaints will be the most irksome, but also that these are just the handy lightning rods for an overall discomfort with what must be even to the most adept and practiced, an unnatural way to interface with an admittedly hostile environment. For that is just what a spacesuit is, an interface with vacuum, with temperature extremes, and with the slow micrometeorite rain. Against other dangers of the alien environment, like cosmic rays and solar flares, it offers almost no protection at all.

The real point is that existing suits (at least) are not easy to don or doff, are cumbersome to get around in, interfere with free natural motion, and make manipulation difficult and clumsy. Where different pressures and atmospheric mixes are used in the spacesuit than in the habitat or vehicle supporting the sortie, pre-breathing is necessary, adding patiently or impatiently wasted hours before and after the venture in which little useful or satisfying can be accomplished. Spacesuits add to, rather than diminish the degree of difficulty and exertion the called for activity would of itself entail.

Improvements are certainly possible. The constant volume hard suit would eliminate any prebreathing requirement and, if, as we have suggested, entry to and egress from the suit were made from a turtle-shell life-support pack backed into a conformal docking port, the whole airlock ritual with its wasteful exhausting of precious habitat atmosphere in each cycling, could be engineered out of existence. [cf. MMM # 90, NOV '95, "Dust Control"]. NASA may not feel the need, but frontier pioneers will soon demand such a development.

But why use spacesuits at all?

(1) Vehicles can dock directly with other vehicles and with habitats or other pressurized facilities, allowing "shirt-sleeve" access *from anywhere to anywhere else*.

(2) At any given settlement or development site, all pressurized facilities will run more efficiently if they are interconnected via pressurized passageways and streets - save

where activity with some risk of cross contamination requires prudent isolation. And such interconnection will create a larger shared mini-biosphere with greater forgiveness and buffering.

If the outpost or settlement is wisely designed, much routine outside activity such as system maintenance, vehicle maintenance, replacing volatile tanks, etc. can be done under the protection of a radiation shielding canopy or ramada. This would allow lighter-weight suits, more comfortable to wear, easier to get around in, and easier to manipulate through - a more user friendly vacuum-work interface.

And for field work? The turtle back suits will disencumber crew vehicles of the more massive airlock apparatus. But personal one-man wheeled or walking vehicles with feedback or virtual-reality-operated manipulators ("buppets" for body puppet, after muppet for mitten puppet), will again allow shirtsleeve comfort and freedom of motion as well as less restrictive personal activity for the occupant/driver/wearer.

The motivation and incentive to develop such replacement hardware will be strongly felt among those engaged in longer tours of duty, and considering "reupping" for duty tour extensions. As the "outpost interface" begins to morph into a "settlement incubator", the demand for such hardware will squelch all bean-counting objections.

Predictably, there will be those few who need to feed their macho "rugged outvacman" image. Singly, or in small groups, they will put on suits and go outside to do their thing, ride around on lunar Harley hogs, go mountain climbing or whatever. Maybe they will have annual rebel outvac picnics at which they can pretend they are feeding their helmeted faces with roasted ribs and buttered corn on the cob after doing the three-legged race and the raw egg toss. Perhaps they'll promote an amendment to guarantee their right to bear spacesuits.

Seriously, there *will be* genuine and worthwhile activities providing both adventure and challenge and which do require a spacesuit — like exploring a lavatube complex. Lunar spelunkers are sure to become a proud and exclusive fraternity, luring many a young kid with wanderlust and dreams of becoming a famous discoverer.

And there will be daredevils too, who in spacesuits, may try to walk a tightrope across a rille without a net, or free wheel down a mountain slope (look ma, no brakes) in an effort to see if there is after all some lunar equivalent of a terminal velocity in vacuum, and if so just how high it might be.

For most Lunans, visitors or settlers, wearing a spacesuit will simply not be an acceptable *modus vivendi*. Any sense of novelty, for kids or newcomers, will quickly wear thin. Face it, the spacesuit, as much as we take it for granted, is a quaint uncomfortable activity restricting contraption doomed to become a Flintstone-like anachronism.

The space suit will always be part of lunar frontier lore. But the stubborn situations which demand its use will be fewer and fewer as time goes by. As a result, it will quickly fade from everyday lunar life. Perhaps every able bodied lunan will still put one on now and then. But the occasion will be the semiannual depressurization drill, much like our school days fire drills, or lifeboat drills the first day out on some ocean-going or spacefaring cruise ship. MMM

⇒⇒||THE QUEST FOR||⇐⇐ ELBOW ROOM

by Peter Kokh

Relevant Readings from Back Issues of MMM

- # 5 MAY '87, "LunARchitecture" [MMMC #1]
- # 28 SEP '89, p 5, "Sardine Can Fatalism" [MMMC 21]
- # 48 SEP '91, p 4 "Hostels: Foreword" [MMMC #5]
- # 49 OCT '91, pp. 3-7 "Hostel Share of Workload" [MMMC #5]
- # 50 NOV '91, pp. 6-8 "Hostel Architectures" [MMMC #5]
- # 75 MAY '94, p 1 "Lebensraum"; pp 4-6 [MMMC #8]
"Successful Lunar Appropriate Modular Architecture"
- # 80 NOV '94, pp. 9-10, "Stretching Out" [MMMC #8]

"Canned" habitat space

If spacesuits are restrictive, so will be "canned" Made on Earth habitat modules. In the beginning, there will be no easy alternative. On the Moon, local building materials and the factories to produce them and use them to manufacture shelter components will be an early "priority", read "not-immediately-realizable". Competing designs for habitat modules to be built on Earth and shipped to the Moon will be judged both on how compact they are and on how light they are. These are unavoidable shipping concerns with all foreseeable transport options.

There is a long tradition behind sardine can space, much of it in pre-nuclear era submarines. That people on short tours of duty a few months long at best can adapt to such cramped hot-racking conditions with minimal privacy or other personal amenities is well established. Anything is bearable if there is light at the end of the tunnel.

Relief from good human factors design

But a lunar Outpost Interface is not meant to be a military operation. It is a facility that cannot fulfill its mission if it does not foster experimental and even artistic creativity in learning to adapt to an utterly unfamiliar environment with no experience-recognizable assets. The base will have to be much better designed than a W.W.II era sub to foster the high morale needed for success under the challenging circumstances. Pairs of berths used in shift sequence can trade off shared elbow room personal space, via a movable partition. Common areas can be cheerfully decorated and partitioned to create the illusion of more complex, therefore psychologically more generous space. There should be getaway retreats one can sign up to use, and quiet spaces, and noisy gregarious spaces. And there should be rotation of duties, qualifications allowing.

Hybrid rigid inflatables

Well before "in situ architecture" using locally produced building materials begins to supply substantially more spacious quarters for personnel, activities, and operations, hybrid "rigid-inflatable" modules that compact for shipment, and expand upon deployment, all the works and systems in a rigid attached component (end cap, floor, ceiling, or central core). Such hybrids with their fold down, pop out, snap up furnishings opening into the inflatable space out of the attached rigid works section, will solve the frequent objection to inflatables based on the need to spend much time outfitting

them after deployment. [see the MMM # 50 reference above.]

These hybrids will allow more generous, if still tight, personal quarters, and common space for recreational activities which could not previously be supported. more importantly they will offer space for more storage of equipment, samples, and experimentation — all prerequisites to advancing to more demanding mission tasks in the overall framework of learning how to live and work productively on the Moon. **Time sharing and other tricks**

Time-sharing of all common facilities by a full three shifts will always be essential to getting the most product out of every facility and piece of equipment per dollar spent and time elapsed. On Earth, the part time use of facilities in line with day shift chauvinism is the single most wasteful aspect of all terrestrial economies. Fortunately, on the Moon artificial lighting sequences allows us to engineer out of existence any advantage of one shift over the other, removing all chauvinism and preferential treatment.

Providing the option of duty reassignment and or the chance to be reassigned to other sites, or at least to visit them, will greatly relieve the symptom of feeling trapped and caged. The flip side is that this need will motivate parties involved to open up ancillary sites, making a humble down payment on an interdependent multisite domestic lunar global economy.

Made on Luna shelter

Even with this expanded repertoire of tricks, imported pressurized space will remain at a premium. The flip side is that there will be an equal premium, a reward incentive, for the early development of lunar building materials and an ever expanding suite of shelter components made from them. The options most frequently considered are lunar steel, lunar concrete, and lunar glass-glass composites. The points on which a decision will be made are these;

- √ mass of capital equipment for processing, manufacturing, and assembly and construction that must be brought from Earth to realize the capacity.
- √ number of man-hours needed to process, manufacture, assemble and deploy equivalent structures in the competing materials
- √ diversity and variability of modular plans to which the competing module suites lend themselves

For successful "Lunar Outpost Conversion" i.e. transition from an Outpost Interface to a Settlement Incubator, timely steps must be made to develop lunar building materials and manufacturing and construction methods suitable to them. We must take the plunge, not just talk about it. For more, see the MMM # 75 reference given above.

lava tubes - real but limited relief

The use of spacious lunar lavatubes which provide lots of ready made protected "lee vacuum" are most attractive for the expansion of area-intensive industries and warehousing operations. But in themselves, lavatubes do not address the need for expansive pressurized volume, only the doing away with the need for emplacement of regolith shielding. In lava tubes the same solutions apply: good human factors design and time sharing, the use of hybrid rigid inflatables, followed by the introduction of shelter space built of lunar materials.

Well down the road, if ways are developed to safely seal and pressurize their vast volumes, lava tubes could provide all the elbow room Lunans will want for a long time to come. But that day does not seem to be just around the corner.

Altered expectations

The American expectation of some 750 square feet of housing per person, will not translate well to the Moon, nor should it. In the typical room, many spaces are minimally used. Dining rooms for example. Even bedrooms. The Lunan home architect / planner will need to develop multi-use spaces, with fewer rooms that are in fuller use.

Bedrooms can double as office, sewing room, den, or whatever. How? Back to the Murphy bed and the efficiency apartment idea. A bed that is unoccupied and neatly dressed may look nice, but two thirds of the day is just wasting dearly bought space. Dining will be another function that time-shares space with other activities. And so on. Native-born Lunans who've known no other way to live, will look on our homes as expressions of an obscene waste of space. (A four bedroom home to himself, this writer is more guilty than most).

The Great Home concept

This said (on the need for fuller time use of domestic space), opposing considerations *demand* attention. Families and households do not stay the same in their need for space. They grow and they contract. Our typical response is to move to larger or smaller quarters as appropriate. Or we add on to existing structures as the household grows, building additions.

As the pool of new housing may be in priority demand for new arrivals on the Moon, the mobility index of Lunans could well be much lower. Moving may be a less facile solution. Nor will expansion be easy. In the early era, habitat space is likely to be modular and individually shielded against the host vacuum. That will make construction of additions a much more expensive, difficult, tricky, and even risky proposition than on Earth. It'll be more logical and easier to build a homespace large enough from the gitgo to accommodate the average fully grown family, perhaps even with "mother-in-law space". The "Great Home" concept.

Properly designed, a Great Home's temporarily extra volume can be put to good use. For example it can include a separable autonomous apartment that can be rented out to new couples on a waiting list for their own home, or as bed and breakfast space for travelers. Or it can house a family's startup cottage industry. It will be easier and less expensive to put room space designed for future household growth to good use, than to disruptively construct add-on room when needed.

The street

The pressurized passageways of the settlement will be the glue that holds everything together. Modular individually shielded pressurized units will open onto the street/alley/gallery network, tying everything into one continuous minibiosphere complex. We suspect such passages will also be multi-use social glue areas, with broad enough shoulders for landscaped strip parks and garden terraces, areas for marketing cottage industry wares, wears, and homemade foods, for rummage sales and street entertainers, sidewalk cafes and relaxing park benches amidst the thriving activity of an intensely productive settlement. Like our suburban malls, settlement streets will be

the place the place to hang out and socialize.

Well sound-buffered, the streets will be active 24 hours serving a fully three-shift settlement, with no shift having any natural privileges. During the nearly 15 day long dayspan, streets can be naturally sunlit around the clock. During the equally long nights span they can be artificially lit.

Commercial and industrial space

In similar fashion, shops and stores (those that are not Ma and Pop operations, anyway) and factories will need to justify their expensive pressurized square footage by being open for business and operating around the clock to serve and employ three equal shifts of the population. This will even go for administration, libraries, schools, and parks. Nothing short of this can possibly be justified.

Tricks again

As with domestic spaces, good human factors design can make small spaces seem larger. Important in public spaces will be variety and change of ambiance from place to place. Much as in the Moscow Metro (subway) each station is a totally different work of art remarkable unto itself, street architects and landscapers may be called on to give each individual passage its own personality, probably with strong neighborhood involvement and feedback. Surface finishes can differ. Landscaping patterns and the planting mix can differ. And surely, as a unique expression of each neighborhood, sidewalk-showcased cottage industries will differ. The result will be to make the settlement-as-a-whole seem satisfyingly larger and more "metropolitan" in flavor and complexity than its small population might suggest. That'll be a happy, healthy effect.

More than a short term problem

Some generations into lunar development and settlement, Lunans may begin to move into more Earthlike settings as pressurized megastructures are built within which individual buildings of a type more familiar to us can be built, open to the faux sky blue firmament of a crater spanning dome or rille-bridging vault or within a spacious sealed, pressurized, yet sunlit lava tube complex. We dare predict space will still be at a premium. For we've been neglecting (rather postponing the discussion of) something vitally important.

Mini-biospheres need elbow room too!

It is not enough to relieve psychological crowding for the inhabitants. If they are to thrive, it is even more important that the biosphere be ample and grow, not just in pace with the population, but well ahead of it. That is it should be the goal to quadruple the supporting biomass as we double the population, so that the per capita biosphere support increases to a more healthful, more Earthlike ratio. Not only will lunar settlements see the return of the farming village, we will want to add wilds and nature preserves, greatly diversify the flora as well as the food crop mix, and continue to work in ever more wildlife. Long term, it is only such a development that can secure a settlement's future, advancing it toward biospheric self-maintenance. Also long term, it is only the hope and expectation of continued real progress in this direction that will make lunar settlements psychologically healthy places for Lunans to live and work and raise families.

Conclusion — The quest for elbow room will be a permanent feature of Lunan settlement culture. 

ORIGINAL AND STILL ONGOING PRODUCTION OF GLASS FROM MOON DUST

by Peter Kokh

Foreword - "Natural Production" on Earth

"Manufacturing" is increasingly a strange word, for literally, it means "made by hand". Yet more and more the involvement of human hands is reduced to pushing buttons, sometimes just on a keyboard. But behind the "manu" is still the "mente", the mind. In that sense, we can hardly speak of Nature manufacturing anything. Yet "natural production" of many useful things does occur, and the historical foundations of human economies are rooted very deeply in these natural productions, as opposed to purely human manufacturing. It is very much as if human industry relies on recipes using "not quite from scratch, prepared ingredients". All you fellow bachelor chefs know of what I speak.

Our terrestrial economy owes a great debt to the natural production of sand and gravel, marble, granite, slate, and veins of concentrated metal ores. These handy prepared materials have been naturally produced through the eons by geological processes. And of course, where would we be without those biologically assisted geological processes that have resulted in the natural production, and warehousing, of limestone, chalk, coal, oil, gas, shale, and other fossil derivatives? "Natural Production" - if you will not admit "Natural Manufacturing" - has given our species an enormous handicap, without which, for all our pretentious brainpower, we might still be in the caves or in the forests.

"Natural Production" on the Moon

On the Moon, these particular natural productions have not occurred. Luna is geologically dead, and has been for a long time. That said, Nature is still very much alive on the Moon, and busy, in a way we are sure to find very helpful.

Our outpost construction efforts, at least long term, stand to gain from the natural production of craters, rilles, and lavatubes. When it comes to future production of building materials and processing in general, while the chemical and mineral assets of the Moon would seem very homogenized in comparison to those of Earth, there has been some helpful beneficiation and enrichment. Highland soils are richer in aluminum, magnesium, and calcium. Mare soils are richer in iron and titanium. The splashout from the Mare Imbrium impact event is enriched in the so-called KREEP deposits: potassium, rare earth elements, and phosphorous.

More, we suspect the as yet unsampled central peaks of large craters represent upthrusts of deep mantle material; and that may prove a useful starting point in the production of some useful chemical elements. Finally, we have hope that some of the crater impacts were caused by asteroids rich in elements otherwise scarce on the Moon - like that which caused the Sudbury, Ontario astrobleme, source of much of the world's nickel and copper.

Regolith 1.03

1.00 Nor does the list of prepared lunar assets stop there. Incessant meteorite bombardment through the eons has

pulverized the surface to a depth of several meters (yards \pm) forming a powdery blanket called the "regolith". Because this material is representative of the host lunar endowment, it is a handily "pre-mined" source of most everything we will want to process on the Moon. Thanks to the natural production of the regolith, we won't be "strip mining" the Moon.

1.01 One of the special handy features of the regolith is the presence of a considerable amount of pure "iron fines", unoxidized (non-rusted) iron particles. Some years ago, Seattle LUNAR Group Studies (SLUGS) determined that if you excavate a site (for the placement of a soil-shielded habitat), you will find in the material removed, enough pure iron particles from which to build the habitat to be placed in the excavation. This resource can be recovered for the price of a simple magnet. [MMM # 63 MAR '93 "Sintered Iron from Powder"].

1.02 Another special enhanced feature of the regolith is a considerable bounty of adsorbed solar wind gases [MMM # 23 MAR '89 pp 4-5 "Gas Scavenging"; MMM # 38 SEP '90 p 4 "Introductory Concepts of Regolith Primage"], thanks to eons of buffeting of the surface by the Solar Wind, blowing outward from the Sun's surface. Involved are considerable amounts of hydrogen, nitrogen, carbon, garden variety helium, helium-3, neon, argon, and krypton, all recoverable through the application of a little concentrated solar heat.

1.03 Nor is that all. A third natural production within the regolith has been going on - again for billions of years. The natural production of glass spherules from the heat of micro-meteorite impacts.

Impact-derived Glass Spherules

SOURCE: *Planetary Science: A Lunar Perspective*. Stuart Ross Taylor. Lunar and Planetary Institute, Houston, and Research School of Earth Sciences, Australian National University, Canberra. © 1982

Glass: [Random House Dict.] [1] a hard, brittle, *noncrystalline*, more or less transparent substance, produced by fusion, usually consisting of mutually dissolved silica and silicates ... [2] or other ... natural substances with similar properties such as fused borax, obsidian, etc.

[Physically, glass is considered to be *an extremely viscous liquid*. Thus glass is markedly different from both crystalline and ceramic materials. Transparency or translucency, while common, are not automatic nor essential characters.]

Impact-derived lunar glasses are commonly found as spheres, the rotational shapes assumed by splashed liquids, ranging widely in size. 100 microns [μ] in diameter is typical (i.e. about a hundredth of a centimeter or 4 thousandths of an inch). [p. 128] Interestingly enough, this size/shape range are what we find on Earth for algal and bacterial one-celled microfossils, though the composition is totally different [p. 134].

The spherules are often flattened owing to the degree of plasticity at the time they "landed". Broken pieces are common as are irregular masses coating larger particles in blotches. The spherules are themselves commonly "cratered" by even smaller micrometeorite impacts than those that led to their formation. Colors range from colorless through pale yellow, green, brown, orange to red, and black, and show a clear relation to refractive index and to chemical composition

of the regolith material that became glassified by heat [p. 128].

Some glass spheres have inclusions of iron and nickel of foreign (meteorite) origin. Overall, the glasses are identical in composition to the host regolith material from which they were transformed [pp. 129-133].

These glass spherules are found in all lunar regolith soils, though the percentage by weight and volume varies.

Lunar Glass from other sources

Not all naturally produced glass on the Moon comes to us by way of meteorite impact heating. A primitive basaltic glass is represented in the Apollo 15 Hadley site "emerald green" samples [15425-6], comprising as much as 20% of the soil around Spur crater. And mare-forming basalt eruptions and volcanic fire fountains seem responsible for the orange glasses [74220, actually ranging in color from yellow to black] found on the rim of Shorty crater at the Apollo 17 Taurus-Littrow site [p. 128, pp. 297-300].

Industrial and other uses of glass spherules

Lunar glass spherules are *not a starting point for optical glass* and optical glass products like window panes and lenses, *nor* for the production either of high melting point fiberglass or low melting point glass matrix for the fabrication of "glass-glass composite" building component items [the MMM-proposed trade name for this GGC material is "Glax"]. For these things it will be necessary to start from scratch with composition-controlled batches of ingredients. As this will depend on prior processing and production of the relatively pure ingredients needed, such building materials and construction items — as important as their local manufacture are to the goal of lunar settlement self-sufficiency — will be an achievement priority for a later phase of settlement industry.

Glass spherules, given their uncontrolled composition and color, still offer a number of useful product possibilities and applications that will give the early outpost/settlement-to-be an economically significant leg up. Here are some:

As is: (domestic)

- √ abrasives and sandblasting material
- √ water filtration

Remelted and blown (domestic and export)

- √ early jewelry, art objects, giftware, souvenirs
- √ early "issue" glassware, dishes
- √ table/desk tops, lamp bases, etc.

Sorted for color (domestic and export)

- √ early vitreous glazes
- √ (jewelry and decorative ceramics)

Transformed by pressure and heat (domestic)

- √ zeolites to add back into sifted powder-free regolith for use in agricultural soils

The list of capital equipment needed is modest:

- √ a way to extract from regolith (without confusion with similar size breccia and lithic particles)
- √ size sort machine
- √ color sort machine
- √ furnace and blowers

As goals of lunar industry and export development, these product lines may seem minor. But together with the use

of sintered iron products and regolith scavenged gases, they will work to jump start *early and easy* industrial diversification, cutting a small but significant part of the import burden, and giving the pioneers a well-deserved sense of achievement.



The *Made-on-Luna* logo will have humble application at first, but thanks to prior "natural production" and serendipitously provident stockpiling of "not-quite-from-scratch materials", Lunar pioneers will be the beneficiaries of an industrial and economic handicap analogous, if not similar, to those we have enjoyed here on the cradle world. MMM



Moonbase Siting – aluminum in perspective

Thanks again for printing my [Larry Jay Friesen] articles in MMM #s 94 and 95]. May I respond to one of your comments at the end of the one about propellants? When I emphasized the need to look for aluminum as well as oxygen for mineral feedstock, I did not intend to say that we would not also have needs for iron, titanium, etc. on the Moon. I was trying to make sure that people would not EXCLUDE aluminum, even by the accident of simply not thinking about it.

It may be well known by all readers of the Moon Miners' Manifesto that we will need a variety of mineral resources to support a lunar community. But the reason I made such an emphasis on getting aluminum is because many of the researchers in the field, the scientists who are actually working on developing oxygen extraction processes, still seem to be focusing exclusively on ilmenite reduction and to have blinders about looking seriously (at long enough to do actual development work on) other possible processes, or about getting anything out but oxygen. At least, this seems to be true for some of the planetary scientists I am personally acquainted with here at Johnson Space Center.

I am not sure why this is the case. It may be because ilmenite reduction is a simple process and therefore easy to design "suitcase pilot plants" around for early manned (or precursor) lunar flights. It may be that ilmenite is lower in its energy requirements than other processes (I have not looked into this).

Whatever the reason, I have not yet found arguments that seem to be convincing enough to these people to get the research community to broaden its horizons, and actually do DEVELOPMENT work (as opposed to mere paper studies) of alternate extraction processes, in particular processes that will also extract metals in general, and aluminum in particular. If you have ideas for arguments that might be persuasive, I might listen to suggestions.

I am speculating that part of the conceptual

gap may be that most of the research community are scientists and are thinking in terms of a (to them long, but to us) short time horizon. They may be thinking in terms of reducing support costs for a scientific research base, not in terms of a full fledged, self supporting lunar community. This paragraph is sheer speculation, unsupported by careful scientific research.

Even if we wind up with pure mare regolith to work with, we can still produce aluminum, though. The process might be different, starting with different feedstock, and the yield will be lower, but 7 % is still nothing to sneeze at.

Larry Jay Friesen



On MMM's Graphic Titles

My wife has commented to me, and I tend to agree, that the graphics used in MMM article titles are often too much. A little of that is fine, but we both find it can be an annoying distraction, because beyond a certain point, they make the titles *difficult to read*. For example, on my second article, we both found that emphasizing the chemical symbols in Aluminum and Oxygen was appropriately cute. The little rocket taking off in "Flight" was a neat touch. But having an italic font for "Propellants" (and only for the first part of the word!) and putting the little tic marks above "Bases" seemed completely pointless so far as either of us could see, and made both words quite a bit more difficult to read.

Larry Friesen

[EDITOR's comment: MMM is not a professional journal in which unadorned text might be proper, but is a monthly reading potpourri aimed at a very wide space-interested readership. MMM tries to cover some of the very all-encompassing vectors of the space frontier. The idea, and our hope, is to lure readers to read, rather than skip over, articles about topics in which they may have had no previous interest. One way of doing that is with graphics or illustration. My own talent as an illustrator is very very limited. I have humbly tried to improve through practice. Solicitations for illustrations have met with little success. One artist, Dan Moynahan, illustrated three articles for us six or seven years ago, then disappeared. Others have offered but not (yet) delivered. Often that leaves me with graphic illustration of the article title or key word(s) as my only way to visually set the tone and catch the reader's eye. I am sure my achievement score is not good, but I try.

In the case above, the italics of "propell[ant]" were meant to suggest energy and motion; the "little tic marks" above the word "Bases" were meant to suggest a space frame holding up a layer of shielding. The lesson for me is that I must not assume that what I find obvious, guarantees that others will find it so. Again, I can only try. As to the valence of aluminum, of course you are right, as the formula Al_2O_3 demonstrates (the abundance being correlative to the valence).

In last analysis, MMM means 60 or more hours of *intense labor of love* a month. It's my football, and if I am no longer having fun with it, I'm likely to tuck it under my arm, and just go home. None of us want that. **PKJ**

"Lunar Broadcasting"

by Gregory R. Bennett <grb@asi.org>

Section 3.3 in the Artemis Data Book

As seen from a given point on the Moon, Earth will wobble in a box that measures plus or minus 7.7 degrees east to west (longitudinal libration), and 6.7 degrees north to south. The longitudinal libration is due to the elliptical orbit of the Moon about the earth, and the latitudinal libration is due to the inclination of the Moon's axis to the plane of its orbit.

Lunar equator is tilted 1 deg 32 min from the ecliptic

Lunar equator is tilted 6 deg 41 min from its orbital plane

Orbital plane is titled 5 deg 9 min from ecliptic

(these figures add up to make the first numbers)

To put this into perspective, Earth subtends an angle of about 2 degrees in the lunar sky, so it's moving roughly 3 times its diameter way from a mean point.

Earth subtends an angle of about 1.9 degrees, as seen from the Moon. Earth will slowly move within this box over a 28-day cycle. The box will be tilted depending on your latitude on the Moon. At the equator, it's rolled over 90 degrees. At the poles, it's as I've shown it here. At other lunar latitudes, the angle of tilt will be (90 - latitude) degrees.

To keep an antenna bore-sighted on Earth, it would have to slew the rate of about 1/2 degree per day. We'd want the antenna to cover the whole 2 degrees of Earth to allow for continuous coverage from horizon to horizon. Of course, people at a given location on Earth would be able to receive the signal for half of each Earth day.

Reception Times

Sometimes we'd get prime time in a given city; sometimes not. Programming could be adjusted for the cities along the strip of longitudes that will receive the signal in prime time. Advertisers in Chicago would pay more for a commercial spot at 7 PM than at 3 AM. That's OK; when it's 3 AM in Chicago it's 7 PM in Sydney, so our programming will be about what's up at the Opera House instead of how well the Cubs could play baseball on the Moon even though people in both of those cities would be receiving the signal.

Note that this situation, with the Moon halfway between Sydney and Chicago when it's 7 PM in Sydney, occurs at a specific phase of the Moon. Moon aficionados on Earth will learn to tell the phase of the Moon based on what kind of programming is coming to them, and vice versa.

Earth-tracking techniques

The easiest solution to tracking earth would probably be to calculate its position, but if we want a stand-alone antenna guidance system to point an antenna, we could use a radio direction finder. Earth is radio-noisy across all the bands, so it should be very easy to close the guidance loop on radio signals. Infrared should work, too. Earth is a very hot body against a very cold sky except during a terrestrial eclipse.

During an eclipse, it would be easy to find the limb of Earth occulting the disk of the sun up to totality. During totality, use the camera to find the body occulting the solar corona. I'll bet Earth looks really pretty during a total eclipse, with the sunlight refracting around the atmosphere to form a ring of fire. The Luna City Hotel will likely be booked up decades in advance for those events. **GB**

The Spiritual Aspects of Settlement



We end our series of articles on the varied ramifications of the lunar environment for settler culture with a discussion of how human spirituality and religious sensitivity might be affected and transformed in the process. It is the whole man and every aspect of his existence that

transplantation to this unprecedentedly new and different world scene will force into new directions of as yet unexplored possibilities.

We trust you will not be offended.



IN FOCUS A better "litmus-test" for space-friendly candidates

1. Candidates for national public office should show more than pro forma support for the Space Station as presently budgeted: **Any and all add-ons to Space Station Alpha as presently budgeted should be commercialized.**

2. We should look beyond thoughtless support for any resurrection of Bush's DOA "Space Exploration Initiative". **NASA's deep space program must be redirected from "exploration" to "resource prospecting"**. We need more *Prospector* class probes to the asteroids and other Solar System objects, prioritized according to accessibility.

3. Candidates should support an aggressive expansion of current NASA Research and Development programs and aims. **NASA should be charged with timely development of critical pathway technologies.** Among these are

- aerobraking
- pace tether applications demonstrations,
- artificial gravity missions and ultimately a permanent artificial gravity orbital laboratory for testing long-term human physiological adaptation to fractional gravity,
- demonstration of increasingly plant-assisted life support systems and of the recycling of wastes aboard Station Alpha
- demonstration of beneficiation and extraction of elements other than oxygen abundant on the Moon
- demonstration of the feasibility of production of useful building materials reliant on available lunar (/Martian) resources
- demonstration of manufacturing, fabrication, and construction methods based on such materials

- wireless power transmission tests from the shuttle and/or station
- remote sensing of permafrost and subterranean voids,
- and similar projects to pioneer technologies needed to open the space frontier to extended human activity.*

4. Candidates should support for continued expansion of the envelope of present Space Commercialization legislation. **Additional opportunities for entrepreneurial involvement in space at all levels should be facilitated by Congress.** (See #1 above) The great bulk of currently enacted and proposed commercial space legislation initiatives concern space facilities on Earth, vehicles and payloads going to orbit, and participation in NASA contracts.

We must begin identifying commercial opportunities "in" orbit and beyond. A Space Cabotage Act would mandate commercial transfer of payloads between orbits and might include kick motors intended to boost shuttle-carried payloads into intended higher orbits or into deep space. The intent is to limit NASA's transport operation to the Shuttle itself, recognizing that NASA's involvement in operations is not an apt precedent for the regime of future activities in space. This would guarantee the rise of commercial companies to handle any Earth-Moon ferry operations for example, and pave the way for LEO and loop-the-Moon tourism. Commercial ownership and/or operation of any hotel-dormitory added to Space Station Alpha's budgeted configuration would be logical.

5. NASA should take the spotlight off of "spin-off" "technology transfer" in which consumers get "free" benefits from government developed technologies at taxpayer expense. **NASA should assist and facilitate entrepreneurial "spin-up" technology development.** The goal is to demonstrate potentially profitable terrestrial applications of technologies that will someday be useful or necessary on the space frontier, with the R&D paid for by commercial sales, and the space applications technology going "on the shelf" for relatively inexpensive deployment when needed. An example that comes to mind would be the development of glass glass composites for terrestrial applications (from furniture to architectural elements, to recreational vehicle body components etc.)

6. "Debate" over the stalled Moon Treaty is pointless. **A government-business-industry commission should be set up to create a new Moon Treaty with language that sets up a regime to allow entrepreneurial use of lunar resources for the purposes of relieving Earth's environment-threatening power generation problems in a way that preserves the Moon's naked eye visual appearance from Earth.** Such a regime would seek to set aside and protect areas of especial geological or scenic interest, set guidelines for the territorial extent of commercial and industrial "concessions", enable private property rights for eventual settlers, and set guidelines for progress of future settlements towards political home rule as well as economic self-reliance.

7. **We should establish a University of Luna - Earthside to include an Institute of Lunar-Appropriate Design.** The ULE would take charge of research into the use and application of lunar materials over a wide range of areas with a view to telescoping the transition from an initial outpost interface to an

eventual resource-using settlement.

8. Candidates for national office should foster policies in other areas that are compatible with an “open” space frontier. We need a “Pro-Space Terrestrial Policy. This will include vigorous pursuit of

- the “reindustrialization” of this country
- tax and other incentives for industry initiated research and development in general
- a policy for environmentally friendly industrialization of the Third World, one that puts a strong premium on taping space-based energy solutions
- promotion of power generation options beyond the scope of current vested interests: hydrogen especially
- increased funding for fusion power research and into the He-3 fueling option.

Anyway, here is our “trial balloon litmus test” **PK**

[Conclusion to the Current MMM Series]

in the (new) beginning, ...
(Starting over on the Moon)

The primitive roots of “Lunan” Culture, IV

Last month, we jumped the gun by inferring that that issue’s essays were our concluding installment to the now year-long series of articles on lunar beginnings that debuted in issue # 88. We soon realized that there was yet more to be read in the crystal glass of “the lunar environment”, promising new vantage points from which to preview the shape of any lunar settlement culture to arise.

Here are three additional pieces continuing this web-thread of thought for you this month. While we are sure that these as well will still not have exhausted the ways in which the Lunan character will inevitably be shaped by the physical nature of this brave and raw new world. But any other cultural aspects with environment-based underpinnings we might detect will be deferred for future discussion. **PK**

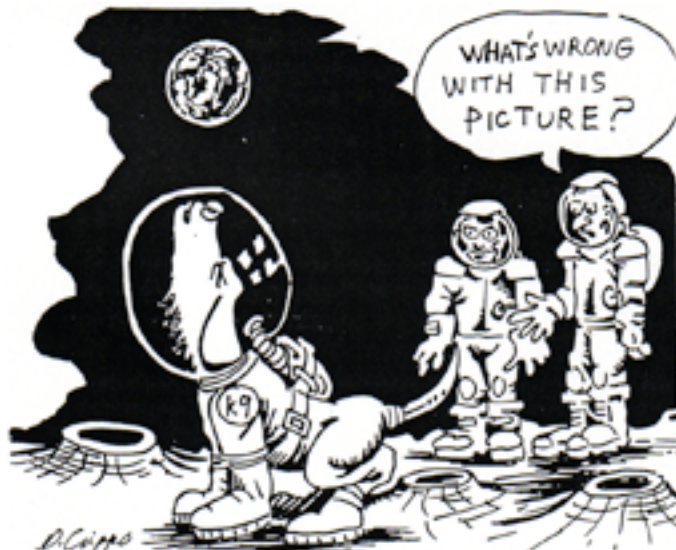

© Dennis Cripps

The Quest for Variety



by Peter Kokh

Relevant Readings from Back Issues of MMM

- MMM # 3 MAR '87, “Moon Mall”
- MMM # 13 MAR '88, “Apparel”
- MMM # 18, SEP '88, “Industrial M.U.S./c.l.e.”
- MMM # 22, FEB '89, p 6, “Hair”
- MMM # 26 JUN '89, p 4, “Toy Chest”
- MMM # 29 OCT '89 “The Role of Cottage Industries”
- MMM # 32 FEB '90 pp 3-5 “Import/Export Equation”
- MMM # 24 APR '91, pp 5-6, “The Fourth ‘R’”
- MMM # 65 MAY '93, p 3 “The Substitution Game”;
p 7 “Fast Road to Industrial M.U.S./c.l.e.”;
pp 8-9 “Stowaway Imports”
- MMM # 68 SEP '93, p. 3, “Cornucopia Crops”
- MMM # 77 JUL '94, pp 4-5 “Cinderella Style”; “Furniture”
- MMM # 85 MAY '95, p 1 “Safety Valve ...”

I’ll never forget an experience as a fresh high school graduate of seventeen, browsing through the Hudson’s Bay Company department store in Calgary, Alberta. The variety of goods seemed much greater than that at similar stores in my native Milwaukee. Here were to be found samplings of wears and wares from all the domains of the British Commonwealth, as diversified a market potluck of humanity as has ever existed.

On the Moon, shoppers are likely, at least in the early years, to have an experience just the opposite. Imported goods will be all but nonexistent and the exceptions will be prohibitively, obscenely expensive. The lunar domestic market will have to rely on its own resources primarily, other space-based markets eventually contributing their own offerings in trade.

“Small Market Syndrome” we might call it. Few people making few products to sell to few people. How do we avoid the expected consequence: little choice, little variety?

prohibitive imports vs. small manufacturing base

The challenge for variety (unavailable either from terrestrially made imports or from the small local labor pool) will affect almost all categories of goods: building materials, vehicles and other conveyances, home furnishings, accessories and artifacts and giftware, clothing, appliances - you name it. Not only will it be harder to find items one really likes, but it will be harder to put a distinctive custom personality on one’s home, even on one’s wardrobe. Such a forecast presumes that the principal entry for variety is mass produced goods from a variety of sources. But there are at least two other avenues by which satisfying variety can be provided under these constricting circumstances.

Potluck customizing

A machine producing a product can be shut down, retooled or given a setup change, and then come back up producing a somewhat different product. Until recently, the U.S. norm for setup changes across a broad range of industries was some 9 hours of downtime. The Japanese manage to cut the average setup downtime to mere minutes. There is no reason why a given piece of equipment cannot be tooled to produce a kaleidoscopic variety using a finite number of styling elements coming into play in diverse combinations. These might be programmed by computer, the changeout taking negligible time, with successive production runs of differently styled products (a radio chassis, a print pattern on a fabric, a handle design on a knife, etc.)

Or the diverse style elements can be preprogrammed to come into play in random combinations, one after the other (as lottery numbers are now stamped on the inside bottom of soda cans for example) Such “kaleidoscopic variegated product machines” could cheaply supply a significant range of individually distinctive items even for small markets. The variegation in each case would be confined to a set and recognizable “family character” range (given available styling elements, materials, colorants, etc.) within domestically supportable resource and feedstock limits without regard for the size of the domestic market. It may be possible to keep track by computer of the kaleidoscopic formula or setting for each individual piece so that patterns could effectively be saved to reproduce on request designs meeting special customer favor.

Finishing by individual artists and craftsmen

It is also possible to produce generic “unfinished” items, that can then be purchased by artists and craftsmen to finish and resell. Or an unfinished item can be purchased by the consumer and then given to an artist or craftsman of choice to be finished according to special request on commission.

While this is a slower, more labor-intensive method of introducing custom variety (than by way of the kaleidoscope machine), the results may (no guarantee) produce more artistically pleasing results, and the only way of producing non-random designs. Those who especially appreciate the hand-crafted and individually designed product may be willing to pay the extra price. But whence the artists and craftsmen?

Almost everyone will have a daytime job producing something essential for domestic or export markets, and for some time the bulk of art and craft may be executed in after hours spare time cottage industry style. Nonetheless, the demand may be so great that this need for variety in modern history’s smallest market may well serve to usher in a “Golden Age” for artists and craftsmen quite without precedent.

We should also see the rise of an unprecedented number of amateur “do-it-yourself” artists and craftsmen principally finishing consumer goods for themselves, and perhaps as gifts for family and other loved ones. To serve this need, various unfinished product lines could be marketed with finishing kits, samples, suggestions, and useful tips. The enterprising factory might even have an area where customers can bring in their purchases to finish in factory supplied facilities using factory supplied materials and tools. This will be an especially economical and popular choice.

Domestic product lines it may become popular to customize are dishes (tableware), ceramic planters, furniture items, clothing items and ensembles, bed linens (in a factory furnished dying facility) and the like. Personalization and custom expression areas outside the home may include product lines that can be customized for entryways opening on pressurized streets, surface shield-roofs, and vehicles.

The subject of customizable “issue” furniture was discussed in MMM # 77 [reference above].

The multi-community lunar world

Once an initial lunar settlement is followed by a second, a third, and more of whatever size, their mutual isolation will inevitably lead to diverse paths being taken along all sorts of lines. Each having its own discrete mini-biosphere, the choices of climate, farm crop mix, and complimentary flora and fauna could be different. One of the results in addition to the obvious one of distinctive ambiances, might be different organic feedstocks to use in decorating clothing and artifacts.

But more basic than that will be differences in the suites of available inorganic materials. For the primary reason for establishment of additional outposts, at least early on, will be to exploit diversely endowed natural local environments. Thus a highland settlement will inevitably produce differently designed and styled goods from a mid-mare or coastal settlement to give one obvious example. While raw materials will certainly be traded among settlements, it would be natural for local artists and craftsman to rely primarily on locally available materials. Trade between settlements then will be as brisk in value-added artist and craftsman finished goods of locally distinctive flavor as it may be in raw materials.

Imports from other off planet communities

As strategically critical materials may well be cheaper to supply from other off-planet sources like the asteroids, Mars, and its moonlets, it will likely be a prime directive of any lunar settlement to support the opening of other off-planet outposts and markets in any way possible. Such a policy will also produce a stronger interdependent off-planet economy all the less vulnerable to interruptions of support from Earth. As these other markets develop, they too may be producing consumer goods which will be a cheaper source of variety than items from out of Earth’s deeper gravity well.

Stowaway imports from Earth

While items imported from Earth either on speculation or by special order will be prohibitively expensive, there are other ways of getting Made-on-Earth wears and wares to the space frontier settlements. **(a)** Clothing worn by arrivals, whether new settler recruits, official visitors, or tourists: such items can be traded duty free for Made-on-Luna wears, and then made available for specialty shop resale, or for playhouse (actors’) wardrobes etc. **(b)** Settler immigrants might be allowed a certain token heirloom weight allowance. Such items, of diverse individually chosen sort, will remain in settler homes for the most part, but eventually end up on the market or in museums. **(c)** A subsidy for the import of art/craft tools (not materials) might be a good investment for all. **(d)** Earth-Moon ferries could conceivably be Earth-outfitted for the outbound journey, Moon-outfitted for the return, the Earth-made items finding their way onto the lunar market. **RAMM**

For generations, Luna will remain a

Frontier

by Peter Kokh

Relevant Readings from Back Issues of MMM

- MMM # 3 MAR '87, "Moon Mall"
- MMM # 13 MAR '88, "Apparel"
- MMM # 15 MAY '88, "Rural Luna"
- MMM # 18 SEP '88, pp 3-4 "A strategy for following up lunar soil processing with industrial M.U.S./c.l.e."
- MMM # 29 OCT '89, p 4 "Cottage Industries"
- MMM # 32 FEB '90, pp 3-4 "Import-Export Equation"
- MMM # 47 JUL '91, p 5 "Native Born"
- MMM # 55 MAY '92, pp 7-8, "Moon Roofs"; "Shantytown"
- MMM # 56 JUN '92 pp 3-4 "Harbor & Town"
- MMM # 57 JUL '92 pp 4-5 "Space Xity Biomass Ratios"
- MMM # 65 MAY '93, p 8 "MUS/cle Substitutions"
- MMM # 83 MAR '95, p 5 "Tarns"
- MMM # 84 APR '95, p 5 "Ghost Towns and Ruins"

"Praise the darkness, and creation unfinished!"

- Ursula K. LeGuin in "The Left Hand of Darkness"

In the Moon, we have a lifeless, barren world that would seem to be anything but friendly. We cannot deal with it at all as "naked apes", but only through the mated interfaces of technology and biospherics. Far more than other "alien shores" we've come across before, on this globe of unrelieved horizons of rock and rock powder against an unfiltered sky of cosmic hazards, we have little of past precedent to go on - little except the spirit of our pioneering past.

The Moon presents itself as a frontier in a much more pervasive and deep-challenging sense than has any previously unexplored and uninhabited niche on Earth. True, terrestrial frontiers have confronted us with challenges we *don't* have to worry about on the Moon: wild animals; strange diseases; the elements of fire, wind, water, and ice; and unfriendly natives.

Our acculturation to the Moon will have to be more far-reaching and all-encompassing than any humans have had to make to date. This will be necessary if we are someday to sit back and realize that through seemingly endless struggles with one problem after another, through battles lost and won, with ourselves as much as with our adopted world, we've somehow come, amazingly, to feel enough "at home" to experience real contentment, to let go of standby plans to return to Earth if in the end the rows of hurdles are just too much.

Frontier Interfacing 1.01

It would seem to some that the technical challenges to extended human presence on the Moon are either solved, on the way to being solved, or present only modest difficulties. In fact, most of the more flippantly offered solutions exist only on paper, or have been tried only in a laboratory without review by the engineers who would have to scale them up, and certainly not in any integrated systems approach. The early challenges include low-leakage pressurization integrity, thermal management, dust control, and overnighing power supply.

Beyond that, we must quickly progress beyond imported habitat volumes (rigid, inflatable, and hybrids) to (a)

demonstration of building materials easily, efficiently, and reliably processed from lunar materials, (b) demonstration of fabrication of modules and modular elements made from them, and (c) demonstration of construction techniques based on them. Nor will this ever be a "been there, done that" step. Lunar pioneers, deprived of the enormous repertoire of manufacturing stuffs and building materials nowadays available on Earth, will be challenged into the indefinite future to come up with new solutions, better fit for newer applications. It will not be enough to demonstrate crude sintered iron technology or crude glass composites (*Glax* - suggested generic trade name for the whole family of likely formulations) technology. Lunans will have to aggressively seek to add to their stable of metal alloys, ever more specialized and higher performing glass and glass composites, ceramics, lunar concrete, sulfur composites, and other inorganic possibilities. All of these curiosities will not come on line together, or quickly. And until we've learned the whole suite of "lunar tricks", for all our achievements, we'll still be on a frontier.

"Nuke" solutions notwithstanding, there will always be more power available during dayspan (when "solar" can be tapped) than during nightspan, baring the achievement of some circum-lunar superconducting power grid in which dayspan solar cogeneration additions anywhere can feed nightspan power demands anywhere else without appreciable losses. This means that the dayspan-nightspan polarization of processing, manufacturing, and labor duties that we have forecast (energy-intensive and labor-light vs. energy-light and labor-intensive) is likely to characterize lunar living rhythms for a long time. Even after good solutions to the overnighing problem have been found, relics of this sunthly task-switching routine are likely to endure, having become endeared to the population.

Settlement architecture and general plans are likewise not soon likely to be mature. Regolith-buried modular towns are the early likely favorite, along with modular outposts within the protective cavernous "lee space" of handy lavatubes. But beyond that the vision lures of more "Earth-normal" type of habitat architectures within atmosphere containing mega-structures: domed craters and crater chains ("catennae"), vaulted rille valleys [the LRS "Prinztown Settlement Study", detailed in the MMM series "Ventures of the Rille People" in MMM #s 26-33 JUN '89 - MAR '90], pressurized lavatubes, and similar farther-future dreams. It is dreams that provide any frontier with its fountain of youth, and with the vision of how it was, how it is on Earth taunting rugged lunar pioneers, they are not likely to ever be satisfied until they have been able to token-reproduce as much of Old Earth on the Moon as possible.

How extensive can lunar settlement become? Those of little imagination would go to their graves content and satisfied if we establish a vintage Little America type outpost with a handful of people. But the Moon is a very empty world, and only the size of the interdependent interplanetary economy can limit the growth of a lunar human population. Even if we limit our settlement areas, including biological natural parks and parkways, to the available "square miles of prime turf" (the definition will change as our capacities change: "ideal size" craters, crater chains, lavatubes, and rilles, etc.) - we will find

enough of that to comfortable house and feed and recreate a population of some millions, only a fraction of whom need to be engaged in production for export. So from outpost to an appreciable off-world population, a progression that will take generations, the Moon will remain a "frontier".

On Earth, pioneering a new territory has always been *relatively* easy. On the Moon we will have to cope with an across-the-board dearth of all the "in situ" assists and handicaps we have enjoyed in the past. We will find no trees, no wood, no bamboo, rattan or reeds or bark. There will be no food for the finding: no fish to catch, no game to hunt, no berries or nuts or seeds to gather. There will be no rich ores of iron, copper, or other metals to prospect. In addition to the lack of wood, there will be clay, no sod, no easy carve stone to use as building materials for shelter, not that we could seal them against the vacuum and cosmic elements *if they were* on hand. Nor, to make ourselves at home, will we find ready or almost ready to use art and craft materials.

We'll be learning what to make and how to make it, over and over again, medium after medium, for a long time. In the process we will cope better and better with the exclusions and substitutions and compensations - the lunar facts of life.

We'll have to adjust to material excesses as well as material insufficiencies. Regolith, regolith everywhere, with its intrusive and all-befouling dust - a challenge to housekeeping, to machinery with moving parts, to health. For most, that first fresh-off-the-lander impression of "magnificent desolation" will soon be replaced with an innocence-lost lasting impression of scenic monotony and boredom. Lucky the few for whom the variability of the lunar topography will never cease to amaze, with every new moonscape around the bend or over the rim! But for all, on the Moon we will be greeted only by rock, stone and dust: geology unrelieved by life with its verdant vegetation in so many forms, along with expanses of water: streams, lakes and seas. It is this combo of the awesome and the beautiful that has made our home world the lonely jewel it is, for as far off into the starry reaches as we have yet to thoroughly probe.

And then there are the black skies - as black by dayspan as by nightspan, unrelieved by alternating equal time periods of horizon to horizon sky-blue, variably pocked with restless white to gray clouds. Again, lucky the few who will never cease to be thrilled and soul-sucked by the clusters and clouds of stars - for these, when all is said and done, remain "the" frontier of human destiny.

Frontier Biospherics 1.01

If "gray engineering" has technical problems yet to be addressed, "green engineering" as it will be required on the off-planet frontier is in its earliest fetal stages. Most, amazingly not all, do appreciate that we cannot return to the Moon "to stay" without being prepared to aggressively phase in a mini- but functionally integral "biosphere" to reencradle ourselves on worlds without atmosphere, hydrosphere, and native flora and fauna. We may have long taken it for granted, but that does not alter the fact that we are quintessentially a symbiotic species. We must take our symbiotic partner with us as we move out into space. That partner is Earth-life in general, call it Gaia if you are not too hung up on the speculative excesses of the Margulis-Lovelock feedback theories. Sure we expect to be

able to engineer an artificial symbiote: chemically regenerated air and water reserves, and foodstuffs à la Solvent Green. And need this approach we will, for cramped conditions on space stations and long-voyage spacecraft. After all, we have a long tradition of substitution of less than ideal life-support means aboard submarines, ships in general, and Arctic and Antarctic research stations. But long term, such measures can only support a caricature of human settlement.

Normalcy, such as a general population will find tolerable, will require "nature" in recognizable familiar terms to be involved. At first this involvement may be token, as with salad stuff cubicle farms, and CO2 scrubbing algal vats etc. But without the sure prospect and unquestionable commitment to a schedule of progress in the general direction of a self-maintaining diversified and balanced biosphere regenerating clean air and water, as well as producing ample food, fiber, and feedstocks of various utilities, frontier settlement will not be psychologically tolerable or self-maintaining in any sense.

Think of the ratio of water tonnage to biomass tonnage on Earth, and then of the ratio of biomass tonnage to the gross weight of the human population on Earth. Obviously, we have a tremendously long road to travel on the Moon or in other off-planet biosphere sites if these terrestrial ratios are the standards at which we ought to aim. Even with such high ratios, we are now seriously straining the recuperative capacities of our environment. How could we pretend to dream of not poisoning ourselves in very short order if, in off-planet mini-biosphere-wanna-bes the ratios of water:biomass: humans are only ridiculous tokens? Our mini-biospheres must be very extensive: not landscaped cities, but farming villages with farms. It is vegetation that must play host to man, not man to vegetation à la houseplants! Until this is the case, and it is a direction to move in, not something we can achieve at the outset, lunar settlements will still be "the frontier".

Diversity of agricultural crops and complementary wild plant species, and a certain amount of post-human wild life as well (such as we find in our own urban and suburban and farming areas) will also be needed to provide a real biological flywheel as well as increasingly good mental health.

Frontier Economic Stratagems 1.01

Those whose bottom line dream is of a settlement invulnerable to the political and economic whims upon which continued lifeline support from Earth must always rest, face a long uphill struggle. In such a campaign nothing can be overlooked, certainly not the dollars, but neither the pennies. In addition to the obligatory money-earners like Lunox and a few other export items that have occurred to nearly everyone, there are innumerable less glamorous potential export commodities. (Anything Lunans can make for themselves at less expense than they can upport an equivalent out of Earth's deep gravity well, they can also sell to other space markets at a similar disadvantage: LEO and GEO lab-stations, factories, resorts; L4 and L5 space oases; and other off-planet pockets of human presence.) As anyone who has ever managed a budget knows, the nickels and dimes do add up, inexorably, often to sums that literally dwarf more attention-getting dollar expenditures.

Thus it is absolutely imperative that the domestic lunar economy not be neglected in favor of concentration on

production of obvious exports. That would be self-defeating.

At the same time, it is clear from the limited suite of economically producible lunar elements as well as the limited manpower pool, that not everything we might want to have on the Moon can in any foreseeable future be produced there. These facts of lunar life suggest **the M.U.S./c.l.e. stratagem** in which Lunans concentrate on self-manufacturing the more Massive, Unitary, and Simple components of various items they need, and be content with importing ready to assemble works cartridges containing any complex, lightweight, and/or electronic elements required. An Institute of Lunar-Appropriate Industrial Design, perhaps on Earth, could design products from scratch for just such a collaboration. Lunar products, all exportable, could include habitat and ship and vehicle hulls and body components, tankage, furniture, appliance casings, etc. In aggregate, the total import burden could be decimated.

The “yoke sac” stratagem is another “piece of the puzzle”. Lunans must move to quickly extricate themselves from realistically fickle umbilical dependence on Earthside policy-reviewers. Instead of supplies received “just on time”, the current newly embraced conventional wisdom, settlement fathers need to over-import any strategic commodities without which outpost failure is certain, swift, and without recovery. If economically recoverable water-ice reserves are not confirmed at the lunar poles, hydrogen will certainly be at the top of that list, along with sister volatiles carbon and nitrogen. A tank farm with a 2-5 year supply (based on growth assumptions) of methane and ammonia ought to do the trick.

Added reserves that need to be built up are copper and other industrially important metals, scarce or not yet economically producible on the Moon, including needed alloy ingredients; nutrient additions for regolith-soil-based farm production; pharmaceuticals or their feedstocks. We’ll also need well-stocked tool cribs and parts stores. The settlers need reserves to buy time in which to open up alternative sources if the squeeze is put on, deliberately or as an unfortunate side-effect of some unrelated policy development on Earth. Strategic planners must seek to open alternative off-planet sources of critical materials in seeking to build an independent capacity to self-replenish them. This is the frontier.

Opening the Solar System in general is part and parcel of securing the future of the lunar settlement. Other off-planet pockets of humanity will make more dependable trading partners. Early daughter frontiers may include asteroid mining operations, a Mars colony and processing and manufacturing facilities on its moonlets, Phobos and Deimos.

But they will also include the genteel suburbs - more sophisticated and Earth-reminiscent space oases settlements - or so the expectation goes. In truth, these artificial outside-in worldlets will be “lunar frontiers” in disguise, where Made-on-Luna items and lunar raw materials will be less expensive than more desirable, more sophisticated equivalents made on Earth.

Attracting Immigrants will also be vital to maintain and grow the settlement in a viable and sustainable fashion. To do this, the powers that be must “sell” the frontier, making its obvious and undeniable hardships come across as “more than worth it”, however counter-intuitively, in light of the rewards. If the “sell” is done right, it will attract the right people, the

ones who *will* be able to contribute to the building of the frontier, and who will find themselves amply rewarded by the intangible satisfactions that *will* come, however haltingly, from being able to make a real difference at ground floor level.

Immigration - selling the frontier

Frontier Adjustment 1.01

Many are the psychological adjustments that will be needed to be made, some of them over and over again, by those who have taken the plunge and made an honest commitment of the rest of their lives to their new adopted home world. They will have chosen to forsake the world of their birth with all its real attractions and advantages.

Consumer types who crave the latest and finest need not apply. Early settlement “issue” wears and wares will be crude and esthetically uninteresting, however serviceable. Local arts and crafts will develop slowly, and with them, the prospect of nicer things. The small market in tandem with other off-planet markets, will mean markedly fewer choices.

Those needing lots of elbow room will also have a hard time of it. Even with inflatable and hybrid rigid-inflatable prefab shelter imports, per person private and common spaces alike will be at a premium until shelter can be built routinely and generously with local materials we’ve learned to process and fabricate and erect on the Moon.

Occupational options will at first be limited, but expand in diversity exponentially as the population grows. There will be those with the psychological “right stuff” who will need at least temporary occupational reassignment.

A very real sacrifice, one most do not expect, is the enormous physiological obstacle that will build up over years in the way of ever returning to Earth, a place where one would suddenly, not gradually, weigh 6 times (not 1/6th) more than one had become accustomed to bearing. Earth, and its beauty and meccas of many kinds, will inexorably become a destination out of reach except for the physically most determined.

Risk acceptance will be a frontier trait that affects much more than the prospects of ever renegeing on one’s settler commitment. Lunans will live far, in gravity well terms, from Earth’s encyclopedic problem-fixing resources. Some equipment may rest unused, waiting unaffordable repairs or parts. “Medical Triage”, however, will be a more powerful concern for the less than supremely dedicated. Despite possible development of time-delay-scourged labaroscopic surgical teleoperation procedures, many less common medical crises, manageable on Earth, may mean certain death on the frontier.

Frontier Prospects

It is characteristic of any frontier for there to be too many jobs needing done for the too few people available to do them. The frontier puts a strong premium on multitalented individuals. Everyone has the opportunity to be useful, even the young, the handicapped, and the elderly. And these ground-floor openings will give all a chance to make meaningful, satisfying differences that will be worth all the hardships.

The LeGuin quote at the top sums it all up. The darkness of hardships and sacrifice are undeniable. But nowhere is Creation more Unfinished than on the frontier. And it is that opportunity for us to help finish creation which makes being human more than a cosmic joke. 

SPIRITUALITY

Effects of the Lunar Environment on Spirituality and on the Reinforcement of Personal Religious Sensitivities

by Peter Kokh

WARNING: *this article reflects the writer's personal spirituality and may be offensive or troubling to some personal sensitivities. Please do feel free to skip it.*

The Human Condition.

Beyond the Mother Biosphere (i.e. beyond Earth) the vulnerability of the human condition will perhaps be even more starkly revealed. Yet, as we learn to cope with "alien and hostile conditions" we may be even more prone to temptations of hubris; "We can go it alone! Look see! We are!" In the end, the raw forces of nature, as heedless of our presence as we are of anthills underfoot, will as always put a damper on that.

For the most part, the reactions of future Lunans will not differ. Those who believe that God plays both sides of the chessboard, determining the physical and material things that come our way on the one hand, and then helping us to cope with all these events on the other, thus making us pawns, will continue to have enormous difficulty handling deep personal tragedies (sickness, death, failure of relationships, financial catastrophe, etc.). This is the standard posture of most "give us this day our daily bread" type religions. You hear it repeatedly in the news when someone who has just won the lottery says, "You see, there *is* a God!" (What about for the the rest of us, who did not win ?) Posture one.

Those who believe, on the other hand, that God lets the world happen without interference ... *ever*, that the material and physical events which effect us are *not* an indication of his personal care and favor, or disfavor - these persons have never that same intense and critical need to know "*why, why?*". They live confident that, should we seek it, we will always find the strength and grace to handle anything that comes our way, and grow to become better persons because of it, and will go on through thick or thin to do just that. Posture two.

Nothing connected with living on the Moon or anywhere else in space, as opposed to living on Earth, will change any of this. Life is *not* easy. This *is*, Earth and anywhere else, is "a vale of tears". No amount of continued technological and medical progress will ever change that. The hardships of life make all of us susceptible to one version or another of the world's oldest confidence game, games which in the end can not deliver consistently. Those who swear by a *gimme-gimme* faith, are able to do so, because, perhaps without realizing it, they have found their own way into the second posture above.

Absence of a given encrading global biosphere.

On Earth, "Nature" has a strong duality, the geophysical forces of the planet itself, and the biological forces of plant and animal life, and their ecosystems. Repeatedly, we see that the forces of the former operate with total inattention to those of the latter. Nature as geophysical force is responsible for all

those manifestations that induce in us profound "awe". Nature as life is more responsible for evoking the sense of "beauty". The two together, a striking geological landscape setting clothed in life, instill a sense of awe and beauty together. This is how it has been for us from time immemorial living on this geologically active planet whose every niche, seemingly friendly or not, life has sooner or later found one way or another to colonize.

On the barren Moon, Mars, or elsewhere, it will be quite a different story. For future space frontier pioneers "Nature" will present herself as geology alone, not tempered by biology. Awe without beauty. Flora and fauna will exist only within manmade environments wherein its cycles will be controlled. The biota of mini-biospheres will come across as post-human "nature", not pre-human "Nature".

Apropos of our topic, in mini-biospheres, even in high domed or vaulted megastructures with an impressive achievement of varied biological diversity, one will not be as moved, on looking out the window of one's residence, to be filled with awe and beauty and remark to himself "God has made a beautiful world". Many may overlook the fact that these artificial biomes rely on genetic resources that we have found given to us in the Mother Biosphere, and feel less humble gratitude, more unwarranted human pride. We can hope that any such initial widespread reaction will in time be corrected and that respect, humility and gratitude will return.

Yet, precisely because of this artificialness factor, a conscious attempt at deliberate harmony may be deeper and stronger among space frontier settlers than it is among most of us. In mini-biospheres everywhere, people will live rather immediately "downwind and downstream of themselves", with any environmental sins coming back to haunt them not generations later, but in very very short order. On the space frontier, environmental consciousness is likely to be extraordinarily strong, both in depth and width.

Mother Earth and Father Sky

On Earth, the presence of *Mother Nature* has always been strong. In comparison, relatively few feel to the same degree the presence of *Father Sky*. It is an important and critical duality, and religious and spiritual traditions which do not speak to it, inevitably provide us with distorting filters through which to interpret the universe about us.

On the Moon, the tables will be turned somewhat, as this time, the surface of our adopted world with its barren and sterile expanses totally naked to the elements of cosmic weather, will clearly belong to the province of Father Sky, rather than Mother Nature who now will greet us only from *within* our minibiosphere *oases*. This major-minor shift in the melody of stimuli that impinge on our spiritual sensitivities will express itself inevitably and subtly in our literature, song, legend, myth, and other cultural expressions.

Man and Nature

The overall effect of the world's various scriptures, *whatever the sacred writers may have intended* in each case, is to serve as an *amplifier*. Scriptures have always been used, and always will be used to *justify whatever* one has done or is about to do *anyway*. This is said not in harsh judgment, but in honest observation.

Judeo-Christian scriptures, specifically Genesis, are often cited to justify a belief that Man is “lord and master” of creation. Nature is chattel which like the chattel version of “wife”, one is allowed to, expected to abuse into submission.

It is against this distortion that the more recent correction which holds we are stewards of nature, has had to struggle. In this paradigm, it is our humble responsibility and great privilege to preserve nature’s balances and harmonies, and to pass them on in as integral a condition as we can, to the generation(s) that follow us.

Sadly, many space enthusiasts who see space only from the viewpoint of hardware (if the only tool you have is a hammer, every problem appears to be a nail) are among those in the forefront of resistance to this new paradigm. But not only must we catch up here, we must move beyond.

Pioneers of the space frontier, living with biological ecosystems in minbiosphere oases, will come to see their relationship with nature as one of much more than stewardship. Our interdependent symbiotic bond with plant and animal species also pioneering the space frontier with us side by side will become fully apparent. We will have progressed beyond wife beating to paternal benevolence and then finally to a true partnership of mutual respect and support.

The significance of the frontier for the spirit

The barren reaches of space, the lifeless shores of raw worlds quite unlike Earth, offer unprecedented opportunity for new illustration, adaptation, expression, and challenge of and to the human potential. (1) using new suites of raw materials, resourcefully, for building, manufacturing, and artistic expression; (2) adapting to all new ecospheric-biospheric niches; (3) overcoming new sets of challenges and difficulties. We’ve done this before as humans left the forests and savannas of Africa to populate the mountains, the coasts, the deserts, the northern forests, even the arctic tundra. Each time we accepted the challenge calling us “:to be all we can be” and thus to reveal ever more deeply the glory and depth of the human plan, of the human soul. The Moon, Mars, the asteroids and space in general now present us with whole new challenges. Not to embrace them would be self-contraceptive, to thwart whatever divine plan lurks in our as yet not fully tapped capacities. We are called to worship, not just on Earth, but from everywhere.

Mysticism and reproductive responsibility.

Many a writer has independently come to the same eureka of understanding: the phenomenon of man is the awakening of the universe as self-aware. Beyond that, and along side it, there is an increasing humble awareness and new sense of awesome responsibility of our neo-technological species as *the reproductive organ of Gaia*. We are not a goal-choosing population unto ourselves. We have a vocation rooted in the nature of what we are as intelligent tool users. We are stewards of Earth-life, yes. But much more than that! In Life’s incredible ongoing epic march from one limited niche-plex to another, it is now our turn to lead the advance. Life first emerged from the sea onto the land and into the sky. Now life would leap from Earth’s surface into space, but can only do so through us. Only by so reproducing beyond the confines of Cradle Earth, can Earth-life/Gaia gain a hedge against mortality and vulnerability to threats internal and external. We have the “essential” role to

play. We are the lungfish of our own latter day time in a cross-the-threshold annexation of a whole new universe of horizons for life. The collective awareness of all this is sure to grow and may well become controlling. Our more-than-environmental responsibility index may reach unprecedented high levels.

Perhaps then it would be more accurate to say that the phenomenon of man is an instance of Earth-life becoming self-aware, rather than the cosmos as a whole. After all that would be quite pretentious on our part to presume. For it is Earth-life to which we have a custodial relationship, rather than planets, stars and star clusters, much less the cosmos as a whole. It is Earth-life we seem destined to help reproduce not the cosmos. As with all metaphors, this one breaks down too if pressed to far. In man, the very last thing you would associate with foresight and intelligence are the reproductive organs.

Earth was fertile turf for the natural rise of life. Most other worlds present conditions which preclude the rise of life, but (as in the case of Mars and Europa, at least) not necessarily the transplant of life already developed. First we will impregnate the still barren sibling worlds of Earth about our own Sun. And some distant day we may begin to transform other stars into true suns by giving them Gaia-fertilized worlds of their own to shine upon.

Or we might here and there find ourselves called upon to reawaken stalled ecosystem starts. It is only in the light of this emergent reproductive fertility of Gaia through man that worlds of themselves barren are now revealed to be not sterile, just virginal. It is only man that can make the Moon, Mother Moon, and Mars, Mother Mars, Europa, Mother Europa. Our expansion, with Earth life or Gaia, into the universe at large is beyond something neat or satisfying to do, it is the fulfillment of an epic vocation bigger than, much much older than man.

We are not alone!

For the first time in human memory, there will now be two settled worlds - for a start. For the first time in history, that means “worlds”, not “world”. Yes, both / all, human (*and Gaian*) worlds. But the crossing of this epochal threshold will tend to reinforce, I think, the widespread expectation that the universe holds others, worlds neither human nor Gaian, in its enormous multi-galactic reaches, and throughout its already long lifetime.

Out in space where there are no clouds, haze, or city lights to damp out of everyday awareness the presence of the star-spangled heavens, our wonder upon looking upward and outward will reach unprecedented highs, remaining much closer to the forefront of consciousness, well beyond that which may have existed in pre-technological times of our own prehistory.

More capable instruments of S.E.T.I. - the Search for Extra Terrestrial Intelligence, will be placed in deep lunar farside. There they will listen to the whispers of the universe, sheltered from electronic noise not only from Earth but also from potential suburban communities in the L4 and L5 lagrangian coorbital fields 60 degrees in advance of, and behind the Moon respectively in its orbit around Earth. Civilizations remaining within their home planet atmospheres might be considered puppy civilizations. Why would advanced peoples choose wavelengths for communication that could be

heard by pups?

There are legends and books about “ancient astronauts” or ancient visitors to Earth from out beyond. Here, by ancient we are going back only a few thousand years. That’s a moment ago on the time scale of the galaxy. On the Moon, where the landscape is billions of years old, not millions, let alone mere thousands, we will see the sweep of time in better perspective. On the Moon, truly ancient traces of past visits would not so easily be erased. That visitors may have come our way once every few hundred million years is a far easier expectation to justify than that they just happened to come along at this particular moment when we are first beginning to wag our tails. Again, since the lunar environment is so preservative, the earnest search for such possible traces and relics would be much more respectable. Either finding sapient relics or catching the sound of sapient whispers from out in the night of space time, would forever change our view of ourselves. We would remain special, even unique, but no longer alone.

On the lunar and space frontier, those interested could expect a quantum level increase in the job opportunities to pursue this wonder in more than meditative and mystical fashion. The expectation of success may begin our transformation in advance of any detection event.

The Cheshire Smile

Jews, Christians, and Muslims have all had their “mystical” periods. The presence of whole, sizable communities beyond Earth will sooner or later give birth to a renewed mysticism. For in truth we need not wait for electronic signals to establish “contact”. We can each, inside, look out into the depths of the universe and say “Hi, I know you are out there.” And we’ll *know* that out there in many places and in many times, others like us are looking out and saying hi as well. Mystically, we can look into each other’s souls and smile. To some that will seem like nothing. But in truth it is a lot. There can be a mystical bond of fellowship based on our common “creatural condition” - we all know “how it is”. No amount of biological, social, historical, or technological difference can change that. The golden key to the Cosmic Club may be a mystical one. Together we can sense the awe, beauty, and wonder of it all, together in a cosmic church.

Recall the fable of the Cheshire cat which vanished except for its smile or grin. Perhaps this is an apt metaphor for mystical C.E.T.I. - [mystical] communication with extra terrestrial intelligence. For there is here no transmission of data. As fellow creatures, we fully share the creatural condition. We are born, we live, and we die, and against many hurdles we are called upon to make personal sense of it all. Life will have its joys and sorrows, pleasures and pains, triumphs and tragedies. These things are transcendental the character of being a creature in a universe - no differences in biology, culture, technology, or economics can touch that. And since these are the only significant things when all is said and done, that leaves us an enormous amount to commune about, to feel kinship through, with which to exchange Cheshire smiles. Alike we share the reproductive vocation of the life stream of our cradle worlds, alike we strive to transcend individual and communal death. In comparison with this, all the data we might hope to learn from radio communication or actual contact with

alien species becomes trivia. Here on the Cheshire plane we are mutual siblings of Creation, not mutual aliens. We may have different Mother Natures (in the sense of womb-world life streams), but share one and the same Father Sky, the tidal force of all the universe and of everything within it through all the ages towards a Beatific Vision. Everything really significant to commune about is right here.

The social character of personal frontier vocations

Each man is an end unto himself, says Ayn Rand. Yet nothing is more true than that the self-involved never find themselves nor learn who they are. Identities are not given; they cannot be found looking inward. Identities can only be forged in finding a role to play in community with others. Yes, we must develop our own talents, but they will find fruition only in the context of others. The hermit will be forever lost and forever “no one”.

On the lunar and space frontiers, the need of everyone to play a part against the tremendous odds will be more keenly felt. Despite the hardships of the frontier, the incessant sacrifices, the dangers and the pressures, the ratio of those who have come to learn who they are in comparison to those who haven’t a clue, will be high. Tanstaaf! (“There ain’t no such thing as a free lunch” - Robert A. Heinlein in *The Moon is a Harsh Mistress*) will become a mark of the Lunan soul.

It will be characteristic of the Lunar frontier, as of all frontiers before it, that there are too many things needing to be done by too few people. For the young, this will bring a total and most healthy turnaround from the depressing situation of today’s world in which it is in contrast stubbornly ever more difficult to maintain the belief that one can make a difference. It is much easier to make a mark in a community starting fresh. Getting in on the ground floor, it is called. The opportunities for all, and the young especially, will be significant. For us, in our age here on Earth, the most many of us can hope to achieve is to “tweak” something trivial. In terms of personal satisfaction in the face of death, there can be no better place to have lived than on a real frontier.

Here too, those with innate undeveloped artistic and craftsman abilities and aptitudes will be much more likely to be motivated to develop them, alongside other talents that on Earth we’d be more likely to consider economically irrelevant. The need for variety, for the personally custom, will provide an insatiable market for the one-of-a-kind creations of the artist and craftsman. This will usher in a veritable renaissance.

In practice this does not mean a higher ratio of artists to engineers, for example, but rather a higher incidence of those who are engineers, mechanics, repairmen, construction workers, agricultural workers, mining and manufacturing workers, managers, and teachers, and on and on who are also, in their off time, blooming artists and craftsmen and musicians and so on. This means a higher percentage of citizens with more fulfilling lives, with greater sense of creativity and accomplishment, with more for which to thank the Lord, and with more ways to express that gratitude.

On Earth, with a little resourcefulness and some carefully chosen tools one can survive on one’s own - thanks to our generous biosphere. Of course, it is less of a challenge to do so in some climes than in others. Here it is comparatively easy to

be a loner, a recluse, a hermit.

On the Moon that will be much more difficult and certainly less rewarding. For one thing, on Earth one leaves the city and the town for rural and rustic areas to “get closer to Nature”. On the Moon, Nature as life will exist only within farm town biospheres. The larger the urban population, the greater, more luxuriant and diverse its biosphere is likely to be. This turns all terrestrial experience on its head, and the cultural-spiritual implications will be profound. The larger the “xity” [a community contained within its own biosphere], the greater the numbers of opportunities to find rewarding work in agricultural, pastoral, even “wild” settings. On the Moon we will learn that we can “commune” with Nature with more depth if we do so alongside our fellows, not apart from them.

Working with the antisocial

If the message of Tansaaf is the soul of the frontier, it is even more true that we can afford to lose no one’s productivity to the luxury of righteous exile from society. To lock up people “where they can do no harm” means as well locking them up “where they can do no good”. On the Moon as anywhere we will find the antisocial, the criminal, those seeking to get their own at the expense of others instead of along with them. But on the space frontier, rechanneling and redirecting the self-fulfillment energies of such individuals will be a much more productive thing to do. “Revenge is mine” says the Lord. Maybe on the Moon we will finally decide to take heed. In a society, when we excommunicate a member, we all become less for it. Practicing apartheid for misfits is an admission that we have all failed, not just the individual we separate from ourselves. And repatriation to Earth will be a doubly expensive option as the passage of a replacement along with his orientation and training must be paid as well.

The very nature of the frontier means that there will be a lot of jobs that are more difficult and more dangerous to do. That does not make them any the less fulfilling or capable of inducing a sense of self-worth. Such jobs can absorb a lot of “hostile energies”. Opening new roads, pioneering new remote settlements, exploring lavatube mazes, establishing outposts on asteroids are all things worth doing.

“Misfits” and “offenders” can be given the choice of signing up for such duty living in communities of their peers in which they are given all the knowledge and tools to do the job and tasks at hand - but no bars, no guards, no warden, thank you. The assignees can elect and impeach their own leaders on the basis of accomplishment and its consequent shared rewards. Spontaneous justice will quickly purge those who slack off at the expense of others. To survive, one must play the game, and in the process learn how to be a citizen. [see MMM # 35 MAY ‘90, p.3, “Ports of Pardon”]

In general, on the frontier, it will be to everyone’s benefit that whatever help is necessary be given to bring out the best in those who are, for one reason or another, showing difficulty in playing a productive role. This means working to integrate the handicapped, the injured, the aged, and the developmentally challenged into activities that contribute to the cultural commonwealth. The very fact of doing so and finding effective ways to channel concern for others for whom “it doesn’t come easy” is bound to have a significant effect on the

spirituality quotient of the settlement(s) as a whole.

The Space Frontier and Monasticism

We might define a monastery as an all male, or all female recruit-replenished vow-celibate community in which spirituality and meditation sublimate the needs for active sexual life and compensatory creature comforts along with dedication to yeoman work beneficial to humanity in exchange for those material needs which they are not able to meet through their own industry and resourcefulness.

In the past such duties have included scribe service, and the maintenance of ancient documents. More recently, monasteries have earned their keep by economic activities which in themselves hardly set them apart, e.g. winemaking.

But on the space frontier, *should* enough men and women heed the very personal call to set themselves apart from all “the world” holds dear in order to dedicate themselves and their lives to some higher service, monasteries could fill some important needs. This will serve an even more valuable purpose in locations with little appeal (if only for the total lack of any place to spend “discretionary income”) or on tedious tasks with little reward.

Some examples:

(1) Staffing a Farside Advanced Radio Astronomy Facility [F.A.R.A.F.] dedicated to S.E.T.I., and/or serving as support staff for a professional staff of astronomers and their assistants. In this capacity they could do construction, raise crops, catalog and examine data, etc.

(2) Building, incessantly adding to, and maintaining some Grand Archives of all Humanity and Gaia in a lunar lavatube secure for the eons against the ravages of cosmic weather. Here would be stored all of the ever accumulating mass of human knowledge: science, theory, religion, culture, (literature, entertainment, religion and belief, performing and plastic arts and crafts); knowledge of Earth present and past (archeological finds and reconstructions, fossil traces) and succeeding alternate visions of the future. Everything stored or preserved on Earth is vulnerable to natural disasters (flood, earthquake, tornado, hurricane, fire, dry rot, insect attack, mold, and the sin of all sins, deliberate destruction as in the burning of the Library of Alexandria or of the Mayan scrolls, both by religious fanatics (may they burn in the hell of hells).

A successful transplant of monasticism to the Moon could serve us well elsewhere; a) Crewing multi-year-long supply runs to and from the outer solar system. It might take four to seven years one way to run supplies from Earth to an outpost on Iapetus (Saturn), much longer still to Uranus or Neptune; b) Staffing remote observatories, for example a solar polar observatory on Pallas with its off the beaten track 35° orbital inclination to the ecliptic; c) Or lifetime staffing of exploration outposts in the outer solar system to and from which regular crew rotation may always be quite impractical.

Conclusion

The Moon will be a life setting unlike anything in the whole of previous human experience. The differences with Earth, in so far as they will impact personal spirituality and religious sensitivities are significant. For individuals and human society as a whole the spiritual repercussions of lunar settlement may be profound.

PK

I SEE YOU'RE BUYING ITALIAN SUITS, NOW!

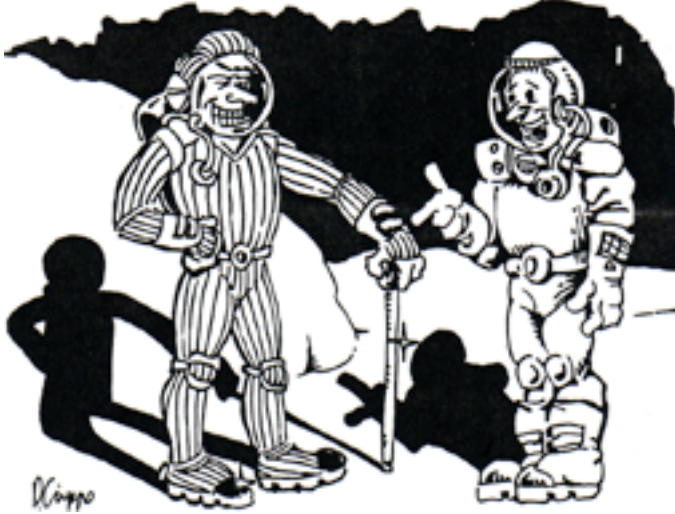

Pluto—Charon Cable Car

by Robert Dinkel and Francis Graham

Pluto and its moon, Charon, are both tidally locked bodies, with one face of Charon facing Pluto, as our own Moon does to Earth. But in addition Pluto has one face to Charon. So neither Pluto nor Charon rise and set in each others' skies.

A straight line could be connected between any two points on the mutually facing hemispheres, and it is tempting to think a cable could be strung as well between the two points. Such a scheme has been proposed for a cable car connecting a point on Earth's surface with a geosynchronous space station 22,000 miles above the Earth. The problem is, with such a scheme, the weight of the cable would snap itself after progressing to a height on the order of ten miles, even if the cable were made of continuously cast steel. It doesn't matter if the cable is made thick; [ed. note by Mark R. Kaehny - actually tapering the cable is generally proposed] the increased thickness adds to the weight. When the weight per unit area equals the tensile strength the cable snaps.

Is Pluto's case different? On June 15, Francis Graham and Robert Dinkel set out to solve this problem. Off the shelf steel is available which has a tensile strength of 311 kpsi so we assume that with some reasonable engineering advance and special order it could be pushed to 400 kpsi.

These rough dimensions of Pluto and Charon are assumed:

- Separation 17,500 km [10,850 mi.]
- Period 6.39 days
- Mass of Pluto 0.0018 x Earth [0.146 x Moon]
- Mass of Charon 0.00018 x Earth [0.015 x Moon]
- Pluto Radius 1500 km [1463 mi. Diameter]
- Charon Radius 650 km [807 mi. Diameter]
- Mass of Earth 6 x 10²⁴ kg.

First, we calculated the libration point L1 by setting the gravitational accelerations of Pluto and Charon equal to each other. Solving the resulting quadratic gives 13,295 km from Pluto's center as the point L1. That will be our upper limit for the weight integral. The lower limit is Pluto's radius.

The element of weight per unit area is

$$dw/A = -\rho drGMPLr^{-2}$$

where ρ is the density of the steel ($\sim 6 \times 10^3$ kg/m³).

Integrating over the entire length of the cable from Pluto to L1

$$\int w/A = 1 - \rho drGMPLr^{-2} = 2.55 \times 10^9 \text{ Nt.m}^{-2}.$$

The required tensile strength is thus 370 kpsi. 400 kpsi, our futuristic steel, can go to 2.75×10^9 Nt.m⁻², easily enough. If a cable can be thus strung from the libration point to Pluto surface, it certainly can be strung from the libration point to Charon's surface.

Thus we conclude that a future cable car between Charon and Pluto can be built, and safe, flightless transport for a Pluto base made. Such a cable car might be valuable at Pluto because of the vastly decreased solar power available for energetic transport by photovoltaically synthesized chemical fuels, and may be worth the use of the iron, (perhaps) a rare substance on Pluto. A Pluto base might be valuable for solar system science of all kinds, a new reference for stellar parallax measurements, and a host of other fundamental science experiments.

References:

Zeilik, M., The Evolving Universe, 4th ed. Harper & Row, NY: 1985 (Pluto data).

Rothbart, H.A., ed., Mechanical Design and Systems Handbook McGraw-Hill, NY: 1964. (Steel Data). **RD & FG**

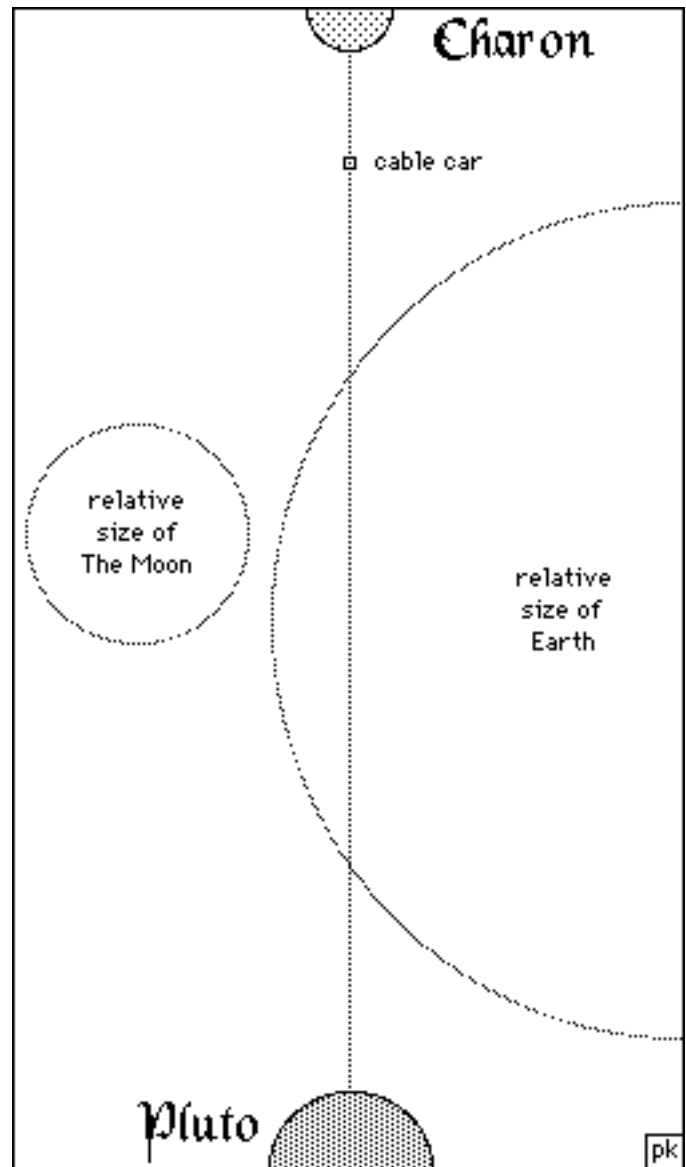

2046 Olympics
The Space Games

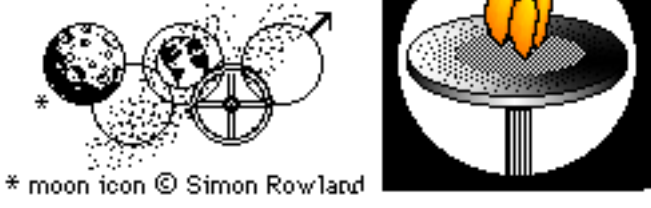

Expanding the Olympics into Space

With the spectacular "Centennial" '96 Olympics in Atlanta still fresh in our minds, we take time out to speculate about the possible expansion of "The Games" into space and its many venues so diversely different from all that's familiar on Earth. What shape will Olympic sports, gymnastics, and track and field events take? Seven big pages, *below!*

MMM tried new type font/size

January 11, 2006. For our readers' convenience, we tried out a different and fuller serif font this issue, MMM #98. We had been using Times 10 for some time. Most of the original hardcopy version of this issue was set and printed in New York 9. Less compact than Times, the new font meant 10-15% less words per page, so there was a cost and loss in total content. PK

Unfortunately, ...

Apple Computer does not allow its New York font to be embedded in PDF files. Go figure! For that reason, in this MMM Classics version, we continue to use Times 10 instead of New York 9.

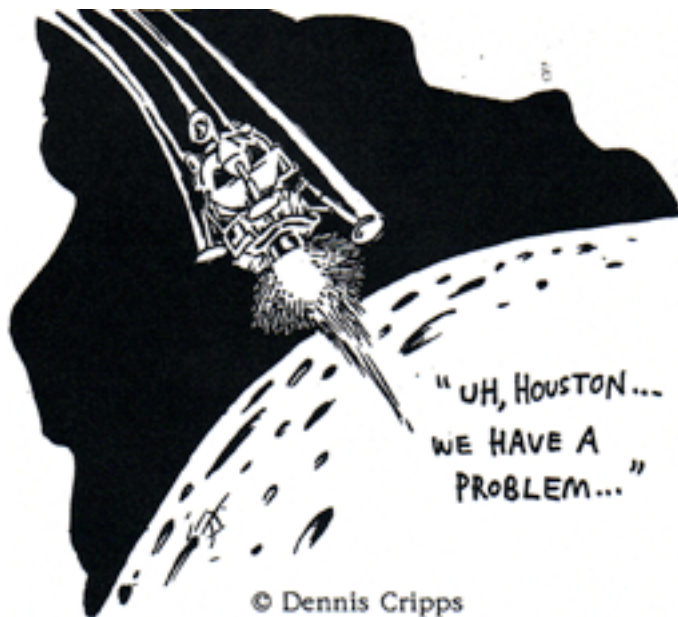

The Sesquicentennial Olympics:
The "Space Games" of 2046
An Exercise in Speculation

by Peter Kokh, with reader input invited!

"There won't be a sesquicentennial Olympics because they are held every four years, so we are talking about 148 or 152 years, not 150." Ah, but the "Winter Olympics" are now held during the intervening even numbered year, and so also might be the "Space Olympics". This moot point handled, and this years spectacular *Atlanta Games* fresh in mind, let's speculate on what the future might bring.

Relevant Readings from Back Issues of MMM

- MMM #9 OCT '87 "Moonsports"
- MMM #11 DEC '87 Space Oases II Internal Bearings
- MMM #30 NOV '90 "Wanted: Split Personality types for Mars Expedition"
- MMM #42 FEB '91 "Locomotion: Mobility in Very low Gravity Environments" by Michael Thomas
- MMM #46 JUN '91 "Footloose among the Asteroids"
- MMM #50 NOV '91, pp. 6-7 "Hostel-Appropriate Architectures: (4) 'Hybrid' Inflatables"
- MMM # 51 DEC '92 "Hybrid Rigid-Inflatables in Space"

Introduction

A lot of different things have to come together before the dream of Olympic Space Games can become even an infant reality. We'll need not only a set of appropriate events, but a significant pool of human talent with sufficient practice time in whatever space locations are involved.

The **population** at the various space sites need not be permanent on a personal level (cradle-to-grave family based), but it must certainly be characterized by long enough tours of duty to allow potential contestants to take to their new medium, be it zero-G or lunar sixthweight, by "second nature".

Long before there are permanent residents of off planet "nations", contestants will compete in the various sanctioned space events as representatives of their home nations on Earth - much as many third world nations are well represented in the Olympics by their youths at school in the developed world.

In time, true space nationalities will arise (e.g. Lunan, Lagrangian), but that time is well off. When it does come, will there be a strong **native born advantage**? Native born Lunans, even native born Martians, may be significantly taller and more lithe than new arrivals and this will give them an advantage in some events and sports, but handicap them decisively in other events more tailored to new arrivals with their Earth-tuned musculatures. This situation will be handled by the sure emergence of a second generation of new space events and sports to suit the "new youth".

Even apart from this, some immigrants will take to the

new gravity situation as if by second nature, “instinctively knowing” how to take advantage of everything of every potential asset of the new environment. Standards of performance, required maneuvers etc. will inexorably change for dancers, gymnasts, etc. as more “natural” expertise develops.

Given the relatively small populations living or just working off planet by the end of the first half of the next century, there will necessarily be a very high contestant to population/**spectator ratio**. But with the pervasively felt need to not take physical condition and muscle tone in space or on the Moon for granted, the percentage of off planet populations engaged in athletic physical activities is sure to be at unprecedented levels. Couch potatoes on the new frontier may constitute a minority. True, there will be other demands for off duty energies like arts and crafts and development of new cottage industries. Still, fitness consciousness will run high.

A large enough pool of physically talented people does not guarantee a Space Olympics, of course. Events and Sports designed for an Earth-normal gravity environment (“1 G”) will be totally inappropriate for “zero-G” venues, and come off in pathetically ludicrous manner in the Moon’s 1/6th G or in Mars’ 3/8ths G. In other words, new sports and events appropriate to the gravity situation of each type of space venue must be developed, standardized, and their level of performance matured, before we can have an event worthy of sanction by the Interplanetary Olympics Committee. We will need major **experimentation**.

To this end off-planet **Sports Development Societies** may sprout up with various chapters in each new venue or class of venues. They in turn will be divided into various “sections” (e.g. concerned with the guided development and evolution of venue-tailored gymnastics, dancing, and skating; with swimming and diving and flying; with track and field type events, with apparatus co-development; with spectator team sports, etc.

For the latter, team sports, a **successful formula** might involve simplicity with yet enough complexity to allow interest-holding variety of outcome. Of course, as more athletes need to be involved in team sports than in individual competitions, they may as much as a generation behind.

Equally critical to the rise of new appropriate events and games will be the material-physical **standardization of facilities**, that is of “tracks”, “fields”, “arenas”, and “courts”. Since facilities dedicated to athletics and sports on a full-time basis will be significantly more expensive as a percentage of overall venue and settlement development expenditures, multi-use gyms and arenas will certainly be the rule. One can design or invent a totally appropriate event or game, which however will not soon, if ever, become real simply because its field-needs are as yet financially or architecturally impractical or incompatible with other more modest, more easily accommodated events and games.

Along with event and sport development, evolution, and maturation, there needs to be then a co-standardization of multi-use facilities and practice courts. As the cost of suitable pressurized host volume comes down, new differently configured and sized facilities can be built and new families of events and sports developed for them, or vice versa.

The Space Games of the future then will be strongly

grouped by the arena type for which they are codesigned. Multi-use will be the order of the day, and any arena, court or field analogs that are developed will have to be reconfigurable for a large variety of athletic events and games. The profligate stadium specialization we see today (especially in the light of more urgent social needs for public dollars) is not an example we will soon see misfollowed on the space frontier.

It will be hard enough to design, build, and financially justify orbital and surface facilities for athletes and contestants themselves. Yet we must provide co-space for judges, referees or umpires, and sports reporters. And what about spectators? By far the greatest portion of sports facility expense on Earth is dedicated exclusively to the accommodation and comfort of spectators. Will we need to reduce gallery size to the point where only token proxy spectators can be accommodated? In fact, in the beginning, the on site population will be small and much gallery space not needed. Live telecasts to others in the host venue watching at home or in the local sports bar can be tapped for combined audio-feedback to the players and contestants. Certainly that kind of feedback will be essential in inspiring **Olympic-caliber performances**.

Potential **Space Venues** are several, and their individual **Prognoses** for Olympic class event development differ. First will come LEO [low Earth orbit], GEO [geosynchronous or Clarke orbit], LLO [low lunar orbit], and other zero-G venues, including deep space vehicles on long duration coasts without artificial gravity (via rotation). But for suitable athletic activities to evolve in such venues we will need a lot bigger pool of talent than the handful provided for in the budgeted International Space Station Alpha [ISSA]. Once complementary commercial sibling orbital facilities start to appear, the prospects will pick up. Meanwhile, the ISSA handful are surely likely to experiment.

On the lunar surface, the outlook is similar, dim at first, much brighter later if a token scientific outpost is followed by a real permanent town of sorts and further improved as secondary sites appear here and there around the Moon. For nothing accelerated development (and/or evolution) like competition.

The same can be said for athletic and sports development on the Martian Surface. As to potential Olympic style activities in “mini-G” asteroid-sized environments, they are likely to get their first real boost from personnel stationed on the Martian moonlets, Phobos and Deimos. Mini-G can be defined as 3% of Earth-standard or less, that maximum being what we’ll find on Ceres, the atypically largest asteroid of all. Because potential asteroid are manifold and all over the graph on their precise levels of mini-G, standardization will be difficult. Perhaps the right approach is to treat mini-G as an “English”, not unlike the coriolis effect, on what for all practical athletic purposes is a near zero-G environment.

Rotating Space Facilities (Lagrange or other space settlements; tether-rotating deep space cruise ships, and rotating space stations and resorts) may mock terrestrial (1-G), Martian (3/8ths G), or lunar (1/6th G) gravity levels, but events and games in played in them will have a sometimes decisive “translation” that will make them more than subtly different. That will be the result of coriolis forces: causing a different

“English” on a ball (for example) depending on whether it is thrown east (spinward), west (antispinward), north (left of east), or south (right of east).

And now for a more complete illustration.

Zero G Events and Games

All known and currently practiced forms of human athletic activity and sport have evolved in a commonly stratified environment horizontalized by gravity at (for all practical purposes) a set given level which we have come to call “1 G” or Earth-standard. This invisible, silent but essential and transcendental component will be absent in space (though it can be inadequately mimicked by artificial gravity against the inner surface of an outer hull by rotation-induced centrifugal force. - On that, later.)

So when it comes to potential events in freefall or drift space, we will be starting with a fresh blackboard - almost. I say almost because some aspects or varieties of terrestrial exercise and sport are independent of gravity. **Isometric and other resistance exercises** where one muscle works against another are an example, and isometric events might replace weightlifting in orbit. Another salvageable component is the resilient ball. Thrown against a surface, a **ball will bounce** whether gravity rules or not. Here then is a start, and a significant one.

Given these two starting points, the next inseparably linked pair of challenges will be (1) to design a versatile space gymnasium-arena-court volume that is relatively inexpensive to erect and maintain, and (2) co-design a diverse family of events and sports activities to be exercised and played therein. And we must do both carefully with due consideration to non-premature standardization.

In space, where pressurized facilities must be maintained in an ambient vacuum environment, curve-contained volumes are the most stable and natural. We are talking about cylinders, spheres, and donut-shaped toroids. In addition to shape, we must pay critical attention to radius and volume as they will shape everything. We will need facilities that are large enough to house satisfying activities, yet economic to provide. Compromise, or better “co-”promise” will be the order of the day.

Cylinders recommend themselves as the most voluminous shapes for the mass involved that can be built on Earth and launched ready to use in space, transported there in cargo holds or, with a faring, stacked above or alongside a rocket booster piggyback style. But even the largest practical such structures (e.g. an empty or emptied retrofitable shuttle external tank) will be rather restrictive in the activities it can host. *It would be a start.*

ET Hydrogen Tank, Dimensions

Inflatable structures such as even larger cylinders, spheres, and toroids can provide significantly more volume for the launched mass. They would have to be easily retrofitable, inside and out (i.e. meteorite shields), A more elegant solution is the “hybrid” rigid-inflatable, the inflatable with an attached rigid works-packed core or end (see MMM # 50, and 51 references above.) Carefully codesigned for a compatible mix of sports and athletic events, all the equipment needed for reconfiguration for the various hosted activities would unfold, pop-out, or be simply stored to be hand-deployed in a compact

works core/locker section which might even include, in more elaborate successor versions, locker room type facilities.

Below: hybrid inflatable sphere (upper)
hybrid inflatable cylinder (lower)

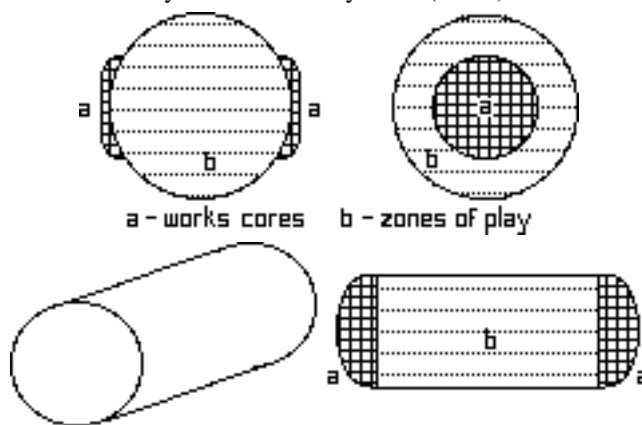

Donut-shaped toroids can come in “tight” (below, left) or loose (below, right) configurations and might offer interesting space in which challenging sports could be played or alternately host a number of simultaneous individual player events.



In the tight torus, the “pinch zone” can serve as “goal” or “backboard” for a *concentric* “basket” of sorts per suggestive illustration below. Various sections of the torus walls can be zoned (lined or color-coded) for different aspects of play. All surfaces will be potential rebound surfaces, some fair, others possibly foul.

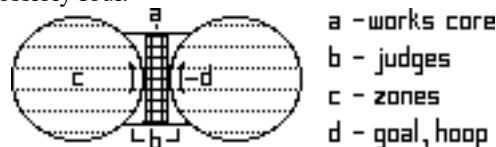

The assumption, of course, is that any of these structures would be non-rotating, and attached by shirtsleeve pressurized passageway to a host station or orbital facility or cruise ship. But we could always play around with “free” rotation, fitted with ball-bearing connections to the host facility so that it could “acquire” rotation spun up or down by the action-reaction play that is taking part inside them. That might certainly add interesting variables! For example, paired contestants or teams could do their thing in opposite directions, and the resultant torque differential would clearly indicate which side is gaining the upper hand.

Alternately, individuals or teams could rally against the clock and starting from a zero-G stop, work to spin up the facility and end up running on the periphery in an artificial gravity situation. Standardization of such a free-rotating facility would have to be strictly controlled and might be too difficult, however. Making provision for judging areas and at least token media and spectator galleries will be a design challenge, hopefully with some elegant solutions. Just as important will be designing works cores or event pantries that will support a diverse yet compatible variety of events and sports activities.

One such facility per zero-G venue is all there is likely to be, if even one! A successful working design easy to erect and maintain is likely to become an instant standard.

Types of indoor zero-G events we can foresee are isometric competition, wrestling, boxing, and other action-reaction ruled events. Air-swimming and air-dancing and gymnastics should prove tele-spectator favorites. versions of handball, ping pong or tennis, Jai Alai analogs allowing play off of all surfaces, even basketball without the running and dribbling. Limited volume may mean rallies (clock mediated competition) or multiple heats.

In a spherical volume, some sort of triaxial reactor like those used by training astronauts should support some fantastic gymnastic routines. Additional reader-developed and illustrated suggestions are most welcome.

Zero-G Olympic events will surely include some "EVA" [extra vehicular activity] type events in space suits or pods. The challenge will be to ensure both the safety of the contestants and competitors and minimize the risk of body and equipment impact damage to the host structure perhaps with nets of some sort or other types of sufficient shield.

A backpack slalom, a hand-grip or hand rail race or rally, muscle powered rail-gripping cart-cycles or dollies, and various sorts of gyroscopically counter-rotating hand wheel devices are imaginable.

Solar sailing is a much prophesied Olympic level competition possibility. But the sail apparatus would have to be weight- and/or size-fixed for Olympic competition purposes, not so for America's Cup type ever-evolving yachting type competition.

Olympic Events on the Moon

Back to gravity, gravity with a difference. All else being equal, people will jump and balls will bounce slower and higher. It will be harder to accelerate and maneuver. Momentum will be Earth-normal as it is independent of gravity. Traction, however, is largely gravity dependent, and will be proportionately reduced, putting a great strain on ankles. Potential rebound-assisting surfaces like walls, even ceilings, may become as import as floors in the play of many sports as well as in gymnastics. Highly banked courts or zones may be common. Because momentum is unchanged while weight is cut to a sixth, carelessness by novices and newcomers is likely to result in an epidemic of impact-related sports injuries.

Early sports facilities may utilize spherical, cylindrical, and toroidal rigid-inflatable hybrid structures similar to those that may become the norm in zero-G locations. However, the early availability of building materials manufactured on site and development of architectures and construction methods appropriate to them may bring down the cost of pressurized sports volume appreciably. This should allow the reemergence of substantial spectator gallery areas and rectangular courts, as well as development of sports and field and track events that require more space for satisfactory play and/or execution.

On the Moon, then, we are likely to see a renewed round of experimentation with the development of second generation Olympic events as the reduced cost of volume, and greater variety of arena configuration becomes a possibility

Yet field size combined with a scale-up owing to the

six-fold reduced gravity militates against any attempts to "translate" or transpose close caricatures of our baseball, football (either), golf, etc. and other field-intensive sports.

Standardization of smaller multipurpose arenas will encourage the earlier spread of additional similar facilities in new lunar towns and settlements and outposts. This means increased completion and faster maturation of the sport or event, and an earlier rise of play to respectably Olympic levels. And that, after all, is our goal.

In sixthweight, indoor cycling is likely. Handball, wall-tennis and Jai Alai analogs are likely. Lunar gymnastics will have to substitute momentum-rebound for gravity to keep the pace of routines less than dreamfully slow. Floors, walls, ceilings and hand rings or rungs everywhere will be part of the action. The risk of momentum impact injury will be a quick teacher, or triage master.

Surface sports out on the desolate moonscapes? Of course. Out-vac events may involve unsuited contestants in pressurized vehicles, but more likely suited competitors on foot or in open-vac human-powered vehicles (cycles, squirrel cages, or American Gladiator style Atlas balls scoring points by rolling into a succession of variably sized craterlets, for example. Pogo stick events? Why not, especially on the Moon!

Some familiar field and track analogs are more likely to be practiced in a suit out on the surface than indoors simply because of the room needed: the javelin, shot put, discus, maybe even the pole vault. Suited surface races may include hurdles and steeplechase type events, perhaps cross-country marathons. One thing not to forget is the dependence of suited contestants on efficient handling of perspiration and heat by their suits. This dependence may insert a level of erratic apparatus-driven variability that may be unsuitable for Olympics sanctioned events. It would seem that indoor games and events which more reliably measure the performance of the individual independent of apparatus will be quicker to be elevated to Olympic status.

Artificial Gravity Venues

Artificial gravity outside centrifuge cages, is something yet to escape the financial prison of paper studies. It would seem that NASA never heard of Von Braun or never say 2001. Artificial gravity comes courtesy of a set of engineering challenges that NASA has lacked either the confidence or the determination to tackle. When that situation will change is anybody's guess. Even in speculative planning of a human Mars expedition, NASA seems determined to send its crew in a zero-G environment guaranteeing that after many months of free-fall coast they will arrive on the scene much too weak to do anything useful. Baby step experimentation with tether induced rotation, for example between a pair of shuttles, between a shuttle and Mir, between a shuttle and a station habitat prior to delivery, are so simple in concept that the refusal to attempt them invites contempt. Nonetheless the day will come.

Rotating environments can provide a range of baseline G values from 1 (Earth standard), 3/8ths (Mars standard), 1/6th (lunar standard), with end cap and ramp ranges everywhere in between on down to coaxial micro-gravity levels. We are likely in time to see a number of rotating habitats at each of these gravity levels.

However, even within an Earth-normal "1G" space oasis, we will at best be able to enjoy Earth-like sports and events, *with a distinctive difference*. For given the small kilometer-scale or even smaller radius of rotation likely in each instance, the coriolis effects which are only insignificant laboratory curiosities on Earth, will infect most athletic and sports activities in artificial gravity environments with a decided "English" on ball trajectories and even personal movements and maneuvers, an "English" which will differ with the vector: N, NNE, NE, ENE, E, ESE, SE, SSE, S, SSW, SW, WSW, W, WNW, NW, NNW. All else being equal (game rules, court size, gravity level, equipment) players newly arrived from Earth will have a variably difficult time adapting to this pervasive "English" or coriolis spin. The results may range from wild to comic caricature, at least early on. (Similar coriolis affected caricatures of lunar and Martian surface sports and events in artificial gravity habitats at those fractional gravity levels.)

Nor is coriolis force the only one that will affect play. Running eastward (spinward) a player or contestant will add to his/her weight measurably, while one running westward (antispinward) will experience noticeably reduced weight. Team captains will surely flip a coin for preferred starting orientation, with teams certainly switching at half-time if not quarterly. A simple assist will be a set of "Cue colors" along the perimeter (fence, wall) of the playing field. For example.

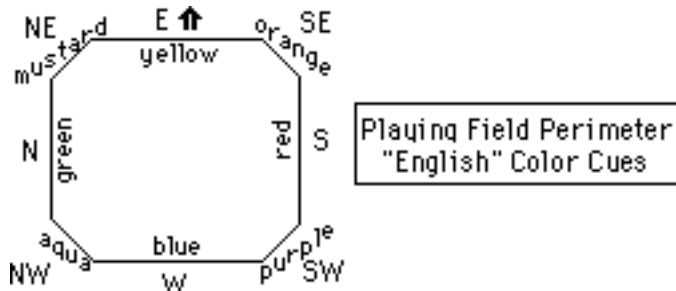

Larger radius, slower rotating settlements will have flatter, less "English"-affected fields. By the same token the weight increases or decreases by those running eastward or westward respectively will be less noticeable. But all this may be many generations in the realization.

Coriolis forces will be noticeable on effect on wind-ups (e.g. for shot put) and may make for more pronounced advantages or disadvantages for right-handed versus left-handed throwers depending upon direction of the throw.

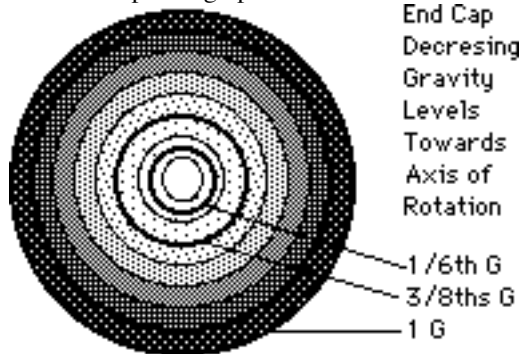

Island I (Bernal Sphere for 1000 people) and III (the million inhabitant Sunflower design of Gerard O'Neill) designs both include end caps, which offer a range of descending

gravity levels on their slopes.

Such end caps will feature gentle ramps and level plateaus. Garden, forest, and park space may be punctuated with apartments, resorts and hotels. If the habitat enjoys a full 1 G at the periphery, on the caps there will be habitat concentration at the Mars-mimicking 3/8ths G and Moon-mimicking 1/6th G plateaus.

End caps offer a very attractive venue for a range of Space Olympic events. The variable gravity will be ideal for a most interesting steeple-chase type event incorporating NE vs. NW and SE vs. SW variations (spinward and antispinward in both north and south caps). The caps of a 1G space habitat might host a space decathlon featuring a mix of events at terrestrial, Martian, lunar, and micro-gravity levels.

In a torus type habitat like the Stanford Island II design for 10,000 people, Martian and lunar gravity levels could be achieved in smaller concentric torus arc sections or complete rings. These could be reached not just by radial (i.e. vertical and perpendicular) elevators but by torus-tangential ramps that would follow Hohmann semi-elliptical orbit paths. The ever tightening (steeper) climb would be compensated by the every diminishing gravity inwards, and vice versa. So variable G steeplechase and decathlon events could be made possible in torus settlements as well - with properly attentive design.

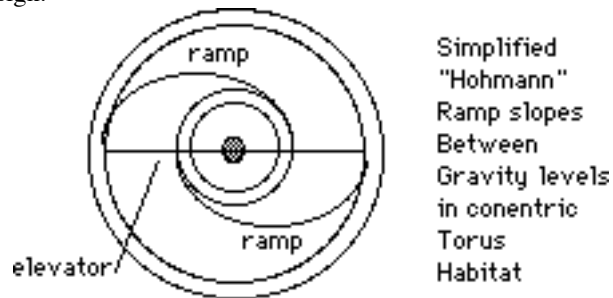

The coaxial areas of Bernal Spheres and Cylinder habitats, if free of power-generation or light transmission activity and equipment could offer a precarious perch for zero-G mimicking events. However the region is unstable in that any displacement at all, however tiny, from dead axis center means inevitable acceleration towards the nearer surface. That, of course, could be part of the game plan of any number of events designed to play on just such a certainty. Events like human winged-flight, gymnastics, and diving (bungee-constrained or pool-bound) are plausible.

One thing such megastructures will offer is a lot of open air, at least by early frontier standards. And the sheer inner surface spaciousness of Island III cylinders, on the order of dozens of square miles, makes them ideal for traditional type marathons. In all honesty, however, construction of such grandiose habitats by mid-century is questionable.

More modest artificial gravity structures, especially tether-split-and-spun deep space ferries on long journeys are very likely in such a time frame and in such mobile venues is where artificial-G sports and athletic events will take root.

Artificial gravity can even be simulated by resultant acceleration, at higher than native levels on the Moon and Mars (even on asteroids) by means of pressurized gyms riding an appropriately banked circular Maglev track at a set speed. Such

a facility would allow lunar and Martian residents to practice for higher gravity level space decathlon events.

We are not used to thinking about the external environments of rotating habitats. But certainly tethered-EVA sporting events outside rotating hulls are conceivable. One possibility dubbed “dangle-jectory rally” was illustrated in the MMM # 30 article referenced above.

“By shortening a tether to the hub, one would advance on the rotating structure; by paying the tether out one would fall behind - simple conservation of angular momentum. Using such maneuvers in tag matches might be risky, but rallye-type events in which one races the clock directly, and competitors only indirectly, attempting to land first on a forward perch or tag ring, then on one to the rear, before returning ‘home’. all by manipulating the effective length of the tether, could provide healthy adrenalin-pumping sport.”



“Dangle-jectory” Rallye: From A to B to C to A

Mars Events and Games

Martians-to-be will develop their own set of sports and track and field events, some reminiscent of those practiced on Earth or the Moon, some uniquely different. Mars 3/8ths gravity level will allow more traction and quicker maneuvering than on the Moon, but still much less than on Earth.

The thin atmosphere will be friendlier to suited surface events than is the harsh lunar vacuum. But Mars still will be a far cry from open air, open skied Earth.

The important thing to remember for our topic, the Olympic Space Games, is that until as yet unimagined forms of transportation drastically reduce Mars’ very effective isolation from the Earth-Moon-L4/5 system, Mars with its own orbital facilities and outposts on the moonlets Phobos or Deimos is more likely to develop its own set of parochial games. Integration into some pan-ecumenical Solar System wide Games seems well beyond the horizon. Travel windows are irreducibly 25 months apart, and travel times, even by proposed nuclear ships, involve some months.

Martian youth back in the Earth Moon system for university studies may carry the Martian flag into Olympic Space Games competitions. Of that concession, we can be sure.

Mini-G Venues

What about the asteroids as venues for the pursuit of the Olympic athletic ideal? Ceres, by far the largest, boasts only 3% of Earth-normal gravity. (Several satellites of Jupiter, Saturn, and Uranus, as well as Pluto and Charon have gravities in between the Moon’s and Ceres’.) All other asteroid bodies have less than that 3%. In most instances the ambient “mini-G” is so minimal as to merely put an “English” on activities that are near zero-G like. The same type of events that work in freefall will work with a little adaptation in mini-G. Those choosing to live in such locations or working there on assignment will surely compete among themselves.

The remarks made about Mars’ participatory isolation

go double for the asteroids, any of them singly, all of them as a group. Low delta-V trajectories notwithstanding, infrequent windows and long travel times and low human populations will make them the ultimate competitive sports boondocks. Again, asteroid-raised youth back in the home system for school, will proudly carry the banner of their adopted worldlets in the cislunar Space Games.

Mini-G wrestlers will not need a pad. Indoor corridor handrail races, slaloms, and steeplechases will be popular. On the surface, cable and handrail off-ground races will work. “Claw walking”, a horizontal analog of rock-pick climbing, is an idea of Michael Thomas (reference above.) Heavily ballasted isometrically hand and foot pedal-powered squirrel cage (rimless? i.e. just spoked?) cycles could carry contestants in races or rallies over the surface.

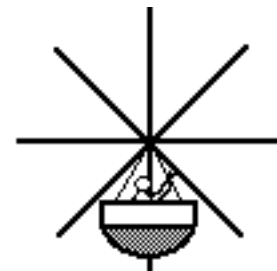
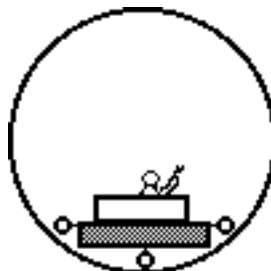

Even among themselves, in clock mediated events where participants are far and long separated by distance and time, records and winners will be hard to pin down. There is simply too great a range of mini-gravity levels. Classes like boxer weight divisions (heavy weight, middle weight, welter weight etc.) are one way this might be handled.

A Space Games Decathlon

Development of a well-rounded Space Games Decathlon type competition will mark the coming of age of the future Space Olympics. The winner will be dubbed “best athlete in the Solar System”, probably with protests from the Martian Media and disdain by Martian settlers. Oh well!

The question is should such a Decathlon have some events (a trio) at Earth-normal gravity? The answer would seem to be yes, especially if their are space habitats with artificial gravity at Earth-normal levels. After all, being able to compete under such taxing conditions (and heroically finish the event, even if placing well behind) will be the only mark that will earn the Lunan settler or freefaller true systemwide respect. The mix of events should include a trio of zero-G and sixthweight events each, and even a token Marts gravity level event. Anyway, that’s a stab at it but I wouldn’t dare to be more specific.

Yet longer range, a decathlon type competition that excludes super-gravid events (Martian and terrestrial gravity levels) may emerge to the forefront in Solar System wide games. Ganymede, Callisto, Io, Europa, and Titan all have gravity levels comparable to the Moon’s, and in all the Solar System, no human-negotiable surface beyond Earth’s itself (six times lunar standard) is more gravid, except for Mars (2.25 times lunar standard).

Participation by the handicapped

Non-prehensile limbs as opposed to prehensile ones are designed to handle locomotion in a gravid environment. We

already have a wheel chair race in the Olympics. But in the Space Games of the mid-twenty first century, there may be much more handicapped participation. Especially in some zero-G events, legless amputees may even have an advantage, in open competition with others. Indeed, it might be more of a challenge to design events for which legs are an asset than merely get in the way.

Conclusion: The process of developing and standardizing an appropriate mix of Olympic level events and games will take a long time to mature. We can insure a head start in running **computer simulations** with gravity level, mass, court size and configuration, apparatus mass and design, and rules all factored into the trial model. Such simulations could easily “pre narrow” the wide range of possibilities into a feasible handful of games, events worth trying at some nonprohibitive expense. Such a down select will need the filter of mutual compatibility, arena-wise as well as sufficiently market-tested player and spectator interest alike.

Virtual reality games and events built upon such computer simulations will act as a further filter, though some physically and humanly possible sports and events, however popular to VR players, may be a long time coming if the facilities or equipment they require would be prohibitively expensive.

Will games and sports described seminally enough in the pages of **science fiction** inspire the inventor developers of real future athletic events? That will depend on science fiction fans with sufficient creative imagination and computer simulation skills and determination - an unknown.

Popularity with **tourists** at orbital and lunar resorts will have an effect. But this may be probably minor in financial terms compared to that of popularity with Earth-bound armchair commercial TV or pay-per-view spectators of space athletic and sports event telecasts.

Beyond Earth orbit, **isolation** (Lunar and Martian rural settings, even more so asteroidal ones) will further experimentation. This should yield second generation events rather than and work to delay standardization of an initial set.

A major threshold will be the development and multiplication of **megastructures** in space (O’Neill type colonies, Islands I, II, III etc.) and on the Moon (Rawlings-Bova “Main Plaza” in “Welcome to Moonbase”; LRS’ double-vaulted rille settlements in the 1989 “Prinzton” Study (MMM’s #s 26-29, 31-33) providing very large Earth-reminiscent volumes. In such environments, **human winged flight** will be one of the oft foreseen possibilities.

Some events will rise to **Olympic level play** well before others. New events will be added with each edition of the Space Games. ABC’s Wide World of Sports, will become *Wide Worlds* of Sports. The epic saga of human **adaptability** continues.

2046 as a time goal is a very big challenge. By then a start should have been made on an official Space Olympic event list, integrated into the overall official Olympics program, with official sanction.

Finally, the effect of the Space Olympics and Space sports in general may be to ignite or fan the flames of many a youth’s desire to settle space. **PK**

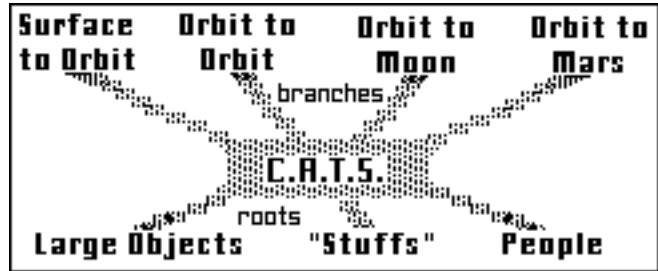

The “Tree of Cheap Access”

One thing almost everyone in the space activist community can agree on is the absolutely vital need to bring down drastically the cost of getting into space. But it is not commonly seen that this is not just one problem but several. Getting “**what**” into space? And just “**where in space**” are we talking about? The challenge is really multiplex. In this issue, we look at just some of the aspects.

Foreword

Why should we think that it is only a question of guaranteeing that we find the best combination of features? Cheap Access To Space, CATS, is not a simple challenge with a single solution. It is a veritable tree of problems with both roots and branches spreading in different directions.

That the best CATS solution for large hardware payloads should by coincidence be the best CATS solutions for shipping materials to space that can be handled in any quantity, or that the best CATS solution for either should by some lucky quirk also be the best CATS solution for sending people, cabinsfull of people, to orbit - that coincidence would be bizarre.

Heinlein pointed out that once you are in orbit you are half way to anywhere. With CATS. we will only have solved half our transportation problem.

We need Cheap Access from LEO to GEO, from either to the Moon, from Earth and the Moon to Mars. These are all different sets of challenges that are likely to have unique solutions.

If all that the push for Cheap Access achieves is to make it easier and cheaper to put communications satellites in orbit, we will have spent a lot of energy without doing a thing to open the real space frontier.

In this issue, we take a look at just some of the many challenges and just some of the possible solutions. We’re sure there are more problems and more good strategies — our purpose is to stimulate thought and vaporize the current simplistic hysteria over something that is more important and far-reaching than most CATS champions have let themselves realize. In the end, CATS, the effort to insure

**ever cheaper access
of everything we want to put in space
to everywhere we want to go in space,
will be an unending story. PK**

Launching "Stuffs" to Orbit

by Peter Kokh

By "stuffs" we mean commodities any which we may wish to ship to orbit or space destinations beyond in relatively high volume and over a long period of time, on a regular basis - which, however, can be shipped in any quantity. A lot of small pay-loads do the trick as well as a few big ones. We are talking about materials or substances, not hardware of set and indivisible fully assembled size. Some examples are water, hydrogen, oxygen, nitrogen, methane, ammonia, (volatiles of which the Moon seems to have a paltry endowment) other gases and liquids, powders, compacted pellets, computer chips and other micro-assemblies etc. In other words we are talking "pipeline" items, not "truckload cargoes", items which at their destination can be placed in tank/bin/silo farms, etc.

That such "stuffs" can be sent to orbit and beyond in piecemeal fashion, does not in itself warrant a conclusion that that is the most efficient way to ship them. It only means that pipeline analogs ought to be considered on their own merits with any high system development costs weighed against the accelerated amortization expected from high volume, individual stuff category by category, or collectively en masse.

The pipeline concept of regular supply, can be satisfied in several ways. Assembly line manufactured cheap small rockets launched often, is but one way. A high per unit time volume of traditional rockets, even if they are small, might add polluting exhaust gases to the atmosphere at a worrisome rate. The option would be to carry aloft only an orbit insertion/circularization engine to ignite well above the atmosphere. The initial boost to high altitude / high velocity suborbital trajectory would be made by an Earth-bound device such as a mag-lev mass driver or a gas gun.

Sandia National Laboratory in Albuquerque is one outfit investigating the possibility, and, of course, the military is very interested for the tactical applications it imagines.

A launch gun or launch track is only part of a working system, however, and promises to be a very capital-intensive, high upfront cost device. Further, it (either) could only accelerate projectiles and their hardy or hardened mini-payloads, at very high Gs (thousands!) into a forward position from which they could be, and would have to be, inserted into orbit by another part of the system.

The partnering part of the system could be a small onboard non-reused motor, or, in the case of commodities bound for geosynchronous orbit in a slot handy to an equatorially sited launch device, some kind of orbiting mass-catcher, anchored by the balance of its inertia and distance permanently overhead and downrange, ever poised to "catch" the steady stream, and somehow able to put the accumulated momentum from the catching process to good use in station-keeping. This can be arranged by putting the catcher at a slightly lower and normally faster altitude, with the steady momentum addition calculated to keep it at geosynchronous velocity all the same. I yield to the orbital mechanics experts.

Launch guns not on or very near to the equator would scatter their charges shotgun style to a whole equator-stradling range of crisscrossing orbits, unless launch was restricted to

just one narrow window a day. That would make poor economic sense, so the incentives to find a genuinely equatorial site should be "insistent".

Launch guns or tracks discharging at relatively high altitude above the thicker layers of atmosphere, would gain the further advantage duo of earning more altitude and velocity for the energy buck, while requiring less faring mass.

What about the pellet containers or capsules carrying the commodities? Three obvious possibilities are (1) Non-volatile self-contained solids might need no protective envelope, the minor ablation being deemed the cheaper option. (ice cubes as a container free way of shipping water would not seem very promising, however). (2) Empty the contents at destination and shipping the empty capsules or pellet projectiles back to Earth as cheap dunnage. And (3) make the container-farings of a material that is badly needed at the destination, in effect smuggling that material aloft as a stow-away co-shipment. Stainless steel, copper, brass, bronze, zinc, lead, platinum, gold, silver are just some of the choices. Effectively, this third method would produce maximum pipeline efficiency.

In the next article, we will talk about prime turf for such a pipelining facility. For this purpose, political, national, military and other usually primary considerations mean little. Location, location, location - as in real estate, for pipeline launch operations, location will be everything, the only thing.

Once assured volume of traffic warrants, for "stuffs" that can be pipelined, the Cheap Access to Space (CATS) answer(s) developed for large payloads and for personnel traffic may be an unsuitably expensive choice. However, until we have orbital or lunar facilities which will require relatively large reusable launch vehicles to bring up massive and bulky assemblies (habitat structure, energy production, material processing equipment - all in an earlier time frame), the demand for pipeline items will continue to be too low to justify the capital expense of a pipeline launcher. But it's never too early to do the research on the tree of engineering options on which the eventual designers and builders of such a system will rely.

TTTTT

The Daniel Cripps Cartoon



ountains made for LaunchTracks

by Peter Kokh

When the idea of using an Earth-captive virtual first stage e.g. a spaceship-carrying rocket-powered dolly accelerating along a track up the western slope of some convenient mountain, first was published, I'm not sure. I first saw the idea dramatically illustrated in the early 50s film "**When Worlds Collide**". The sight of that large streamlined spaceship rocketing up that long slide and then out into space, bound for a planet around a star that would shortly swallow a vaporized Earth whole, is hard to forget. Men have dreamed of reaching space in this fashion for a long time. The ideal mountain, of course, is not on Earth at all, but on Mars, Pavonis Mons. But let's take a look at what we have here on Earth.

We are all familiar with the advantages of launching Eastward from low latitudes, as close to the equator as possible, to get a piggyback boost from the Earth's own angular momentum as it rotates on its axis. The maximum boost, at the equator, is 1,037.9 mph (1670.25 kph) = circumference of the Earth divided by 24 hours in the day. This boost diminishes as you move away from the equator to the north or south. The percentage of available boost at any latitude is given by the cosine of the latitude degree. For example, Cape Canaveral, Florida lies at at 28° N. The cosine of 28° is 0.88295 which gives the percentage [88.29%] of the boost available at the equator, or 916 mph.

We are also, most of us, aware of the penalty, in the form of drag, incurred by launching through a thick atmosphere. If we could launch not only from on or near the equator, but from high altitude as well, launch efficiency would be maximized (translatable into higher altitude, larger payload, or both).

Early '50s science fiction writers almost universally imagined that White Sands, New Mexico would be the major gateway to space. Eventually NASA decided for political, military, and, Oh Yes, range safety reasons that this country's major spaceport would be along Florida's Atlantic coast. But Wernher Von Braun, the make-it-happen guru of modern spaceflight, actually had had a better idea when he proposed that the *World* spaceport be located on a high mountain plateau in central New Guinea, 5° N. Von Braun, of course, was a multistage rocket man, and the idea of using an Earth-captive virtual first stage in the form of a mountain-slope climbing rocket sled dolly would have meant turning over an important part of launch operations to a separate team of scientists and contractors.

While the rocket sled idea remains "a path not chosen", prime fodder for the writer of "what if" alternate histories, the idea is essentially sound. Without discussing the technical and engineering features and merits of such a spaceship launch track, let's take a look at just what actual terrestrial mountains might make the final cut. Here is our short list of the top four, with some comments. We have them listed in order of their summit heights, even though a launch track might not reach it.

Mt. Cayambe, Ecuador

19,160 ft., 0° 40 miles NE of Quito, and 200 miles NE of the major Pacific coast seaport metropolis of Guayaquil. In the Andes, Cayambe is the only mountain on our list with neighboring peaks that might do just as well. The other three (Cameroon, Kenya, and Kinabalu) are stand-alone massifs.

Range Safety and clearance: best clearance is to the north for polar launches, for which Cayambe offers no advantage. 2,000 miles East to the Atlantic over the sparsely populated north Amazon basin.

Mt. Kenya, Kenya

17,040 ft., 0°. An extinct volcano with a beautiful and classic graduated slope. 300 some miles NW of the Indian Ocean port of Mombassa with a railroad connection. 100 mi. NNE of Nairobi and its major airport. The summit is sacred to some Kenyan tribes.

Range Safety and clearance: 300 miles west of the Indian Ocean coast (in southern Somalia) over sparsely populated terrain.

Mt. Kinabalu, Sabah, Malaysia

13,455 ft., 6+°N. Near the north east tip of the great island of Borneo. About 40 miles ENE of the South China Sea port of Kota Kinabalu, and 80 miles WNW of the Sulu Sea port of Sandakan. About 100 miles S of the southern tip of the Philippine island of Palawan.

Range Safety and clearance: 70 miles to open water to the East for eastward launches.

Mt. Cameroon, Cameroon 4.2°N

13,353 ft., 4+°N. 60 miles from the border with Nigeria, 10 mi N of the port of Buea (former capital of the former British Cameroons), and 50 miles WNW of the major port city of Douala. The western slope is subject to torrential rains.

Range Safety and clearance: Open water 25 miles to the south for southward launches only, a major drawback. Some 2,000 miles from the East African coast (in Somalia).

Mountains without the Right Stuff

Excluded from this list are active volcanoes, and mountains that lack good seaport access. Arthur C. Clarke fictionalized ("Fountains of Paradise") a space elevator from a mountain in Ceylon (Sri Lanka) at 6°N. In truth, Mt. Pidurutalagala, the highest peak, is only 8,281 ft. and nearby Adam's Peak a thousand feet less. Both, however, have good eastward clearance over the southern Bay of Bengal.

Any effort to pick a site and build a mountainslope launch track would also have to factor in local political stability or the lack of it. If we were to pick *just one* such facility, serving all the world, my vote would have to be for *Mount Kenya*. It is tall, smack on the equator, central to the world's population, has fair weather, good access to a major port, and arguably acceptable range clearance. TMM

Launching PEOPLE to Orbit

by Peter Kokh

I remember Tom Rogers' audience gripping pep talk at the banquet at the 1988 International Space Development Conference in Denver. He foresaw a day when people - workers, tourists, and settlers - would be the principal item shipped to space. Indeed, people are the one thing it makes sense to ship to space rather than produce there from on site resources. It will be this traffic that opens space. And until this traffic begins in earnest, probably with tourists, space will largely be a venue for a token scouting elite, and for Earth-bound armchair voyeur wannabes - like us.

If this proves true, Cheap Access to Space ("CATS") solutions developed for large hardware items like space station modules and communications satellites may very well not prove optimal for the coming traffic in live-and-wanting-to-stay-that-way bodies. The Space Shuttle was early-on likened to an all-purpose "pickup truck" for space. That doesn't make it qualify as a good bus or highway coach, much less a good family car. The shuttle and its paper study replacements are in fact crewed cargo ships, cargo ships that can take along a small hardy and hardened crew.

While hardware payloads may come in a set range of sizes, occasional oversized loads being low traffic items, the optimum size for a people shuttle will change as the sustained demand and volume of traffic grows. The 29 passenger DC-3 once did just fine. But today, it is often more economical to fly planes that carry several hundreds at once. The point is that a CATS solution not amenable to "scaling up" may be an unhappy choice as a people carrier, even if it does deliver airline style operation and fast turnaround time.

Shuttle time to orbital destinations is short, shorter even than the average domestic airlines hop - not counting the time you may have to sit on the pad prior to taking off! Given the expected shortness of surface to orbit flights, a high "packing" density in the cabin may be tolerable. Demand for a "window seat" may well be higher than that aboard airliners, given that the scenery will be much less prosaic. That "see one cloud, see them all; see one farmer's field, see them all" attitude will not be common, even for seasoned shuttle travelers. This demand, if carriers choose to meet it, may place constraints on cabin design, and may make some SSTO configurations much more popular than others. Right now, in the early stages of CATS R&D, such considerations are at the bottom of the list. But in time, that list will be turned end for end.

Competing SSTO configurations may favor competing ground-based infrastructure (spaceport launch and land facilities). In the early days of space tourism, low traffic volume will bring with it few choices of gateways. If you want to go, you will not complain about flying to a distant departure field. But as traffic grows, at first chartered but eventually scheduled, it will be economical to offer more gateways, departure points convenient to more population centers or perhaps at more major airline connection hubs. If that is the case, SSTO configurations that are the less versatile and place higher and more expensive to meet constraints on spaceport

infrastructure will lose out in competition (all else being equal) to those that can take off from nearly anywhere and land nearly anywhere.

The general public will want lower accelerations than seasoned crews can tolerate. This will be another major design consideration not currently given much weight. Compromises are inevitable, however. It could be for example, that the only way to bring the ticket price down to a mass-use threshold may be the use of an Earth-bound first stage such as a mag-lev sled at a high altitude, and preferably low latitude (near equatorial) "aerospaceport" and there will be few of these if indeed more than one. Such a development will move orbit-bound traffic in patterns opposite to the decentralized paradigm suggested above. The use of piloted piggyback flyback boosters would also tend to limit gateway choices.

When it comes to moving regular people traffic between Earth and Lunar orbits, and between lunar orbit and the lunar surface, still other vehicle configurations may prove to be the most economical. Thus, even though the McDonnell Douglas Delta Clipper family configuration is inherently more versatile when it comes to landing site, not even requiring an atmosphere, that doesn't mean that just because it can land and take off from the Moon (or anywhere else) that it is the most economical configuration in that specialized environment.

Certainly for Earth-Moon ferry traffic, where we are concerned with flight times of many hours to a few days, cubic foot allowance per person will have to be much more generous, with diversions galore.

And when it comes to Mars, the usual "space shuttle" pattern will be set on its ear. Instead of a surface-based vehicle that can get to orbit and then return, we will need, at first at least, an orbit-based vehicle that can land anywhere (look, ma, no runaways) and get back to orbit. Who can say, (let's agree to have fun here) perhaps for that purpose a saucer-shaped vehicle may do better than a winged one. After all, it is the orbit-based "surface shuttle" paradigm that UFO lore invokes.

So while we are supporting CATS, let's be aware that the early answers may not prove to be the best answers - we need to explore all the options if we want not just to open space to more hardware, but also to more - quantum leaps more - people.

TTTTT



by Peter Kokh

In the last article, we suggested that it is conceivable that the least expensive per capita seat to orbit may be a vehicle that is booster- or track-launched from a high altitude near equatorial aerospaceport. Let's play with that idea for a moment - not with the launch track or other captive booster stage options- but with candidate sites.

If we look at existing international airports, making the problematic assumption that our transatmospheric spaceplane can take off and land within the typical boundaries of

such facilities, what are the choices? They are not many. Most equatorial cities of size are ocean or river ports near sea-level.

Here are the three best exceptions:

Quito, Ecuador 0° at 9,500 ft altitude.

Quito is the capital and second largest city of Ecuador with somewhat less than a million people. It is a minor hub with most air and sea traffic coming into the country via the larger, more cosmopolitan sea level port of Guayaquil. The flagship national airline serving Quito's **Jose Marescal International Airport** is *Equatoriana*.

Bogota, Columbia 4.4°N at 8,563 ft.

Bogota is the capital of Columbia and its largest city, already one of the megacities of the Third World urban tropics with over 5 million people and growing rapidly. While it is slightly less well situated than Quito in both latitude and altitude, it is by far the more important air traffic transportation hub. The flagship airline is *Avianca*.

If space-bound traffic grows, Bogota could make an ideal western hemisphere aerospaceport, serving North, South, and Central America, with travelers electing to spend several days taking in the sights of this beautiful, colorful, vibrant, and cosmopolitan city.

Nairobi, Kenya 1.5°S at 8,700 ft.

Nairobi is the capital and largest city in Kenya, in the process of suddenly becoming a Third World super city with several million people, ten times or more its size in colonial days. Nairobi is the air traffic port of entry for most travelers to East Africa. *Air Kenya* is the flagship national airline. If high altitude equator based transatmospherics turn out to be the most economic way for tourists to reach orbit, Nairobi could some day be the "Space Safari™" jumping off point for three continents: Africa, Europe, and Asia (which has *no* low latitude high altitude city.)

Nairobi has the added advantage of being on the southern flanks of Mt. Kenya, whose western slopes offer an ideal site for a launch track for space-bound high volume commodity cargoes.

Top Cities/Airports in Comparison

All three of these equatorial cities have modern airports which accommodate any fleet jet. But if existing hub traffic is a consideration, Quito loses the Western Hemisphere race to Bogota.

Would the national airlines that serve these cities (*Avianca*, *Air Kenya*) expand intercontinentally to funnel most orbit-bound traffic through their home hubs? Or will the traffic be up for grab with other national airlines competing on a level playing field? Might the transatmospherics themselves be owned by *Avianca* and *Air Kenya*, and thus be able to offer discount transfers to and from their hub feeder fleets? All these questions may be moot if the extra cost of airline flights to and from these equatorial hubs added to the cheaper cost of space passage from them comes up to a harder-to-swallow bottom line.

Yet there is more favoring the equatorial hub scenario than lower seat-to-orbit costs. Equatorial Earth orbit locations

(hotels, resorts, and industrial parks), ideally suited for access from equatorial surface hubs, have a great advantage with a launch window to and from every 2 hours or so as opposed to once a day to and from cul de sac higher inclination orbits that maximize access from higher latitude spaceports like Kennedy and Baikonur. And it will be the equatorial orbit stations and depots which offer the most frequent launch windows and best fuel-saving advantages to and from the Moon and other deep space destinations like Mars.

Bogota and Nairobi Interplanetary Aerospaceport could grow beyond their edge as space gateway cities for people. They could become *the* terrestrial centers of solar system trade, trade shows, import and export markets, mineral and energy exchange boards, and more. After all, that is how great cities become great, by leveraging an at first minor advantage in an ever diversifying and pyramiding fashion. Perhaps it is good that there are at least two prime candidate cities, not just one.

And if high altitude doesn't matter?

What if high altitude becomes moot, and any equatorial city can compete for the trade? That opens the door to Guayaquil, Panama City, Cali and Medellin, Caracas, and Belem in Latin America but Bogota should handle that competition with no problem. Douala and Kinshasa might compete limply in Africa. Half a world away off by itself, Singapore would surely become the gateway for all Eastern Asia and Australia. (Its national flagship carrier *Air Singapore* is already the world's top-rated airline with Milwaukee-based *Midwest Express* a distant fifth. Just thought I'd throw that in there with ISDC '98 in Milwaukee only 20 months off.) Even if the advantage is with the high altitude cities, Singapore may garner a respectable East Asian market, its sea-level handicap meaning fewer paying passengers (less gross weight) and higher fares per flight to orbit on comparable equipment.

**Fixed vs. Variable
Cabin Orientation
for Launch & Land**

**i.e. Simple & Safe
vs. Complex and
Problem-prone**



by Peter Kokh

The recent winner of the X-33 competition, Lockheed-Martin's *VentureStar* is an apparently well thought out paper study design by Lockheed's famed Skunk Works, a team determined to overcome the considerable head start of McDonnell Douglas (the *Delta Clipper* program, with an actual successfully flying prototype).

VentureStar has a number of distinguishing features like its linear aerospike engine. But as a prototype upon which a future personnel carrier might conceivably be based it has one very salient characteristic that presents some challenges to passenger cabin design. *VentureStar* will take off vertically on its tail like the Shuttle, and again like the Shuttle, it will land

horizontally. While this was probably not the deciding factor in its choice, NASA's cozy familiarity and complacency with the Shuttle may have added the appeal of psychological frosting to Lockheed's design.

Will passenger cabins on vertical take off horizontal land craft be fixed, so that passengers are pushed into their seats through their backs during takeoff, effectively lying on their backs with legs up, but sitting on their buttocks during landing, seats and postures remaining the same?



**Vertical take-off
Passengers held
to seats by their
backs. Down is to
the rear of the
cabin.**



**Horizontal Land
Passengers held
to seats by the
buttocks.**

How comfortable this take off posture will be for the general public is debatable. Given a choice for the same money, we think the above arrangement will prove disastrously unpopular.

Another possibility is a seat that unfolds into a berth for takeoff, and back into seat position for landing. This may work well enough.



**Vertical take-off
Passengers in
supine position
in futon-seats**



**Horizontal Land
Passengers in
normal sitting
position.**

Clusters of Seats could be in Gimbaled pods free to rotate so that gravity or powered acceleration is towards and through the pod floor, not the cabin floor in general. Force will at all times be felt, through the buttocks and feet. A model for this system are the little passenger pods that take tourists to the top of the St. Louis Gateway Arch.

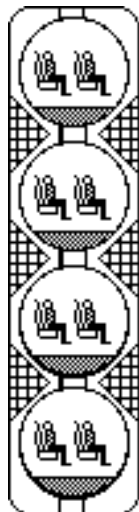

**LEFT: seating position during
vertical take off. No passage
between pods.**

**BELOW: seating position during
horizontal landing. Passage
between pods allowed.**

Crew only access to storage bins



As flights are short, the reconfiguration of seat backs and postures or the closing off of clumsy cramped crawl-space passageways and gimbaling of pods are bound to be distract-

ing, cumbersome, and annoying. Mere annoyance could change to trouble fraught with danger if a seat resists reconfiguration or a pod decides not to gimbal. It is curious that NASA which shrinks from tests of artificial gravity because of the engineering challenges, embraces a configuration which almost mandates one contrived Rube Goldberg accommodation or another. But there is a history of this, witness the Shuttle tile thermal protection system which is just as unnecessarily contrived (and expensive), mandated by an unnecessary choice of reentry attitude and angle.

In contrast, the VTOL, vertical take off and land, and HOTOL, horizontal take off and land, offer one simple unchanging configuration throughout both legs of the flight. "KISS", i.e. "keep it simple, stupid!" Fans of VTOL, the Delta Clipper's way of doing things, point out that a Clipper-configured craft could land on the Moon and take off again whereas a VentureStar-patterned craft could not.

VTOL would give us CATS and CATL (Cheap Access To Luna) in one craft. That is tempting. But is it the best route. Could there be cheaper craft specialized for LEO (Low Earth Orbit) to Luna runs just as VentureStar is best specialized for ground based shuttle operations to space on a thick atmosphere world? We must explore and test all the options. Only then can we have confidence in our choices. "God and Heinlein decreed that rockets should take off and land on their tails!" Maybe. Maybe not. I see problems with VentureStar's mixed mode operation. But it may just work.

FRAMA

Orbit to Orbit Transfers

by Peter Kokh

Presently, rockets must carry along all the fuel, and any extra stages, needed to get a payload in its intended final orbit. A payload brought up by the Shuttle destined for a higher orbit than the Shuttle can reach, must carry along a throwaway pre-fueled kick motor to do the trick. Imagine how expensive it would be to fly to another city if we had to pay the freight for bringing along *our own* taxi (and its fuel) to get us from the arrival airport to our hotel or other destination! Carrying that fuel to orbit means either less allowable payload or a bigger and more expensive booster than would be needed if (a) the vehicle could be refueled upon reaching low Earth orbit, or (b) it was possible to "hire" a kick motor once in low Earth orbit to do the job.

Refueling in low Earth Orbit

Given enough traffic following a given route into space, it should be feasible to orbit automated or remote control "tankers" that they could tap robotically or by teleoperation. Such a tanker could be sent up full, to be replaced and deorbit when empty. In time, permanent refueling stations parked in handy orbits, could "purchase" unneeded residual fuels and oxidizers from some vehicles to "sell" to others needing to refill or top off their tanks.

A 1988/'89 Space Studies Institute study outlined how

such an orbiting cryogenic fuel depot, using spent Shuttle External Tanks, could be set up phase by phase. Most of the liquid Hydrogen and liquid Oxygen needed would be “scavenged” from residual amounts left in other ETs reaching orbit.

There are two logical orbital locations in either case (tankers used serially, permanent filling stations): in the **International Space Station yards**, and in **low equatorial orbit**. The latter would be far more useful, being more reachable, with less fuel, from most locations, and at maximum window frequency. An equatorial filling station alone makes sense for payloads bound for geosynchronous Clarke orbit or beyond, for the Moon, Mars, or elsewhere in the ecliptic-hugging Solar System. Building a refueling station in Alpha Town for vehicles and payloads intended for deep space would be a lot like putting a gateway for Europe-bound Americans in Patagonia. *Kick Motor “Tugs for Hire” - Orbitug Inc.*

The idea of an orbital transfer tug, manned or not, has been investigated for incorporation into Space Station operations. But as we have just seen, given the Station’s intended high inclination (51°) orbit, such a tug would be much more useful in low equatorial orbit.

While the former might be agency operated, heaven forbid, the later is a prime entrepreneurial commercial opportunity. Tugs could be launch company owned and operated (Lockheed Martin, McDonnell Douglas, Boeing North American, Arianspace, Energiya, etc.), or time-share pool operated, or perhaps leased by independent operators. Of the major contractors, Arianspace, able to launch from a 6°N site in French Guiana, has a big advantage.

Legislation to insure the commercial option may no longer be needed but was proposed more than a decade ago in the “Space Cabotage Act.” Cabotage means the “coastal” trade in cargo, after John Cabot, the British explorer of the North American Coast (c. 1497). “Coastal” is appropriate as Earth’s true “space coast” is not Brevard County, Florida but LEO to GEO orbitspace.

Tug fees would of course reflect weight and delta v required for the orbital transfer. But they would also reflect whether the payload to be boosted was delivered to the tug home base (filling station) or whether the tug had to go fetch it in some other orbit first. Tug return to base fuel expenditures would also have to be paid by the shipper. Now if these fees in total are *appreciably* lower than the alternative cost of bringing along a one-use throwaway pre-fueled kick motor, we have a viable entrepreneurial space business opportunity.

Tug services would be “by appointment” and reservation only, at least until traffic grew large enough to attract speculative operators, able to “earn a living” through payloads of opportunity.

Nor does the opportunity exist just for traditional chemical rockets. Tether operated momentum boosters, possibly solar powered, could easily carve out a number of high traffic niches

Manned tugs would be useful for carrying replacement parts to already orbiting satellites needing repair. If this service can be profitably provided in a timely fashion at less cost to the satellite owner than the procurement and launching of a replacement satellite, we have another prime commercial opportunity. Such a manned tug would be a natural comple-

ment to a commercially owned and operated station or industrial park facility in equatorial orbit, serving as home “port”.

Refueling prices could come down once made on Luna fuels are available in quantity and quality. We are talking about lunar liquid oxygen, silane (SiH₄, a methane analog and hydrogen “extender”), and possibly powdered aluminum or liquid hydrogen aluminum slurry fuels.

Each of these “enhanced CATS” scenarios wait on a steady growth in traffic to become economically viable. For low Earth orbit is *only* “halfway to anywhere in the Solar System” [Robert A. Heinlein]. Orbital Filing Stations and Tugs for Hire may be where we will find our CATS price-reducing solutions in this theater of operations. TMM

Earth to Moon & Earth/Moon to Mars



by Peter Kokh

Propulsion Questions

LANTR: (Liquid oxygen [LOX] Augmented Nuclear Thermal Rocket) — In Moon Miners’ *Review* #18, JAN ‘96, Editor Mark Kaehny reprinted an article by Dr. Stan Borowski of NASA-Lewis, about a very promising new propulsion concept which could cut Earth-Moon transit time down to a day, *and* delivery more cargo to boot.

If total transit time is drastically cut, then the mass of shipboard facilities needed to keep passengers amused and content should be less. Less ship mass per capita [per fare] means less fuel needed per fare, or cheaper passage.

NIMF: (Nuclear rocket using Indigenous Martian Fuel)

In Moon Miners’ Manifesto # 30 NOV ‘89, we reported on Dr. Robert Zubrin’s concept for manufacturing both get-around Mars exploration fuel and return-home fuel from Mars’ atmosphere, instead of bringing it along from Earth. This scenario would cut drastically the size and mass of a ship or expedition needed to put a given crew and amount of equipment on Mars.

AEROBRAKE: a ship configuration that can present a large cross-section to the atmosphere upon entry or grazing, allowing it to dump momentum without firing retrorockets. Ships returning to Earth or Earth orbit from the Moon or Mars, and ships headed for Mars or Mars orbit can benefit from aerobraking. But this is an economic plus only if any extra mass needed to provide an aerobraking profile is less than the mass of fuel that would be burned in firing retrorockets. Thus it is a nice idea that presents design challenges.

Dividing & Conquering “Delta-V”: Shuttle-Ferry-Shuttle Rendezvous

At first blush, Moon Direct and Mars Direct - the idea of *transferless* passage from one planetary surface all the way to another - is as mentally comfortable to those of us breast-fed

on science fiction as an old slipper to tired feet. But what costs is fuel spent on changing momentum, accelerating and decelerating. We need to look at the structure of a passage from one planet to another. A few minutes of acceleration - days to months of cruising - a few minutes of deceleration. From the point of view of fuel expenditures, it would be ideal for an accelerating or decelerating ship to be as lean and pared down in per capita mass as possible. From the point of view of passenger comfort, it would be ideal if the long-cruising vehicle be as spacious and full-featured as possible, implying more, not less mass per capita. Contradictory indications, it would seem.

Bear in mind that deceleration and acceleration periods are an extremely brief fraction of total time of passage. Passengers don't mind having nothing more than a seat to sit tight in for short periods. Bear also in mind, that a circuit-cruising ship that does not stop, but only makes once or twice a loop course corrections, need spend very little fuel on anything but emergency power generation.

The elegant answer then, is not Moon direct or Mars direct, but lean Earth surface to cruise ship rendezvous shuttle. comfortable circuit cruise ships for near-Earth to near-Moon or near-Mars passage, and lean shuttles between Lunar or Martian surface and cruise ship rendezvous.

Note that all the delta V needed to go from Earth to Moon or Earth-Moon to Mars is spent on either end by briefly occupied spartan crowded shuttles. In contrast, the relatively luxurious, creature comfort bestowed cruise ships on which 99% of the passage time is spent, use hardly any fuel.

The burden of rendezvous by logic falls on the lighter vehicle. The mountain doesn't come to Mohammed. Rather, Mohammed goes to the mountain. The more massive vehicle has "the right of momentum", yes, akin to "the right of way". If the ferry has to brake into Earth or Mars orbit, making discontinuous interrupted trips to and fro, all such benefits are lost, and to be affordable, it would have to be as spartan as possible, just like a shuttle.

Another way such a scenario makes sense is that the cruise ships on which travelers spend by far the most time, can afford to be amply shielded from cosmic radiation and solar flares, whereas the darting shuttles needn't be.

Now we can hardly run our first expedition to Mars in such a manner. But the benefits are so clearly apparent, that this is mission profile we need to aim at if we are going to sustain any amount of traffic - regularly scheduled expeditions to a sequence of immigration waves to tourism.

Relevant Readings From MMM Back Issues

MMM # 21 DEC '88 "Lunar Overflight Tours"
MMR # 12 JAN '93, pp 2-8 "The Frontier Builder: An Earth-Moon Hotel Cruise Ship". Definition & Design Exercise, Doug Armstrong and Peter Kokh
MMM # 80 NOV '94 "Stretching Out", P. Kokh

Relevant Readings From Other Sources

Ad Astra July/Aug '96, pp. 24-27. "Recycling Our Space Program: *No Deposit ... No Return*", (Earth-Mars Cycling Ship scheme)
Buzz Aldrin and Leonard David



To/From the Lunar Surface

by Peter Kokh

How do we cut expenses for landing on the lunar surface? Use as low-mass a landing vehicle as possible to bring down the equipment, supplies, people, etc. Leave unneeded mass in orbit. See last article. In addition, we can pursue these strategies.

Fuels and Oxidizer from Moondust

- **Liquid Oxygen** for fuel oxidizer is the most obvious opportunity to save. There are many ways LOX can be processed from the lunar regolith soil. "LOX" can even be used to refuel Moonbound vessels in low Earth orbit.

- Less potent but quite adequate, **powdered metals** (alone or in a liquid hydrogen slurry) can be used in place of hydrogen. Abundant lunar aluminum, iron, calcium, and magnesium will do well. **Aluminum** oxygen combination is the most potent but it will take a lot of equipment and energy to produce the aluminum powder. (A 75% aluminum, 25% calcium alloy is easier to keep powdered). Pure **iron** powder is everywhere, especially on the mares, and can be produced easily by passing over the soil with a magnet. The exhaust is rust powder which will fall harmlessly back to the surface without degrading the lunar vacuum.

Densifying Hydrogen Extenders

Hydrogen may make the ideal fuel, but on the dry Moon, even if there is some polar water ice, hydrogen will be a precious commodity and using it - at least in unextended form - will constitute an obscene waste of an invaluable and limited and expensive resource. Two ways to use it as a fuel extender are as a slurry medium for powdered metal fuels (above) and in chemical combination with other elements. One of the hydrocarbon analogs of Moon-abundant silicon will do such as Silane, SiH₄, the silicon analog of methane, CH₄. According to Dr. Robert Zubrin, Silane can be produced in a Sabatier Reactor (the nuclear thermal powered device he successfully demonstrated for the production of methane fuel from Mars' atmosphere).

Economic pressures (impatience for short term advantage and profit at the expense of long term sanity) to use precious lunar hydrogen reserves directly will abound and there are many "damn the future" space advocates ready to do just that - some of them prestigiously placed. By treaty or lunar charter, it is in the interest of future Lunans and their civilization to restrict such use with adequate safeguards and stiff penalties.

Landing without Retrorockets

Mars fans are quick to point out that thanks to its atmosphere, it will be cheaper to land people and cargo on Mars than on the Moon. But there are a few tricks other than aerobraking that can be used on the Moon in similar fashion.

- Krafft Ehricke described a "Lunar Slide Lander" that would dump horizontal momentum into a prepared regolith runway in Lunar Industrialization and Settlement - Birth of Polyglobal civilization" in "Lunar Bases and Space Activities

of the 21st Century” ed. by W.W. Mendel, Lunar and Planetary Institute, Houston 1984, pp. 825-7.

In what we hope is an improvement on this idea, Doug Armstrong and I published an article on “Enhanced Harenobraking” [sand-braking] in MMM # 55, cited below. It is conceivable that some limited application of this trick could be used to shed some of the momentum of an incoming personnel carrier.

- Cushioning Farings of non volatile material - e.g. metal and ceramic foams might land G-hardened payloads on the Moon intact, in specially restricted landing zones where they can then be “harvested”.
- Chicago inventor Ed Marwick has put forth an elaborate proposal in which guided payloads enter a sloping chute dug into surface and encounter ever denser sprays of regolith dust, slowing the capsule down to a halt. Such a facility would have to be as long as a mass driver per level of Gs to be tolerated.

Loading and Unloading Facilities

The earliest ships coming to the Moon to set up operations in any given development area will be “self-unloaders” weighted down with the cranes and winches needed to unload and reload themselves. Landing on and launching from the Moon will take less fuel and be cheaper, once such equipment is set up on a site, thereby establishing a “port”. “Go anywhere” craft will operate at a competitive disadvantage as compared to craft designed to trade via an established lunar surface port facility. Population will follow, so that port-establishment will tend to be outpost and settlement site preemptive. (The same applies to the establishment of fuel processing facilities and fuel depots, harenobraking smoothways, electromagnetic launchers and catchers, etc.)

Electromagnetic Launchers

Mass Drivers have been principally investigated for the regular continuous shipment of unprocessed lunar regolith into space for production of building materials for Solar Power Satellites and Space Settlements. Such devices provide very high G launch over relatively short mag-lev tracks.

Other elaborations are possible:

- value-added pelletizable processed materials
- G-hardened small size manufactured items
- Larger items (cargo holds, personnel pods) in more potent, longer, slower accelerating launch tracks

Reversing mass drivers or Mass Catchers which catch and brake landing payloads have been mentioned and need further investigation for high traffic situations. In most cases this will not require a new facility, just a new “reverse” mode use (where launch demand allows) for an existing mass driver.

Mass Drivers-Catchers are expensive big ticket items. They will lower costs to and from the lunar surface only when amortized over a long period of high traffic use.

Relevant Readings From MMM Back Issues

MMM # 6 JUN '87 “Bootstrap Rockets”

MMM # 55 MAY '92 “A Better Slide-Skid Lander?”

Enhanced Harenobraking”

MMM # 56 JUN '92 “Harbor & Town



To/From the Martian Surface

by Peter Kokh

Early Orbit-Based Shuttles

The first expeditions to Mars will have to use orbit-based self-unloading, self servicing and self-launching shuttles. There are no ready to use port facilities on Mars. An aerobraking shuttle cannot land like *Columbia* and siblings. It can glide-in only to lose most horizontal momentum, but then must either finish the job by using retrorockets to land on its tail or vectorable thrust to land like a harrier.

Preparation of a **runway** for wheeled horizontal landing and take off would make sustained operations easier, but is a down-the-list priority.

NIMF shuttles and hoppers {nuclear rockets using indigenous made-on-Mars fuels like methane and oxygen) will be enormously cheaper to fly than those that must carry launch and return fuel down with them from orbit, indeed, all the way from Earth.

The NIMF scenario is versatile. Shuttles that will be on a location long enough to process their launch and return fuel can land anywhere. For quick trips, a fuel processing plant must be pre-landed on a selected site. A **depot network** of NIMF plants around the Martian globe at well chosen sites will accelerate the opening of the planet.

Early traffic to Mars would also benefit from a fuel processing plant on **Deimos** or **Phobos**, at least marginally. This would be an early high priority item, especially for traffic (processed hydrogen, nitrogen, and carbon volatiles such as liquid methane and ammonia for trade to the Moon in exchange for made-on-Luna equipment / provisions) to the Martian moonlets themselves might be a major development on which Mars surface operations are economically piggybacked and subsidized.

Later Ground-based Shuttles

If sustained traffic warrants (a decision to establish a permanent exploration base etc.) a true port facility can be established. In effect, this would change “Home Port” from Earth to Mars. Such a full-function port facility would be site preemptive, in that by making it far cheaper to land and take off from that location, traffic to other “undeveloped” sites on Mars would struggle at a major competitive disadvantage. Infrastructure is a strong magnet and activity polarizer. First site to establish it, wins.

Any Martian spaceport could also double as an airport. Cargo and passenger aviation on Mars, perhaps with hydrogen-buoyancy lift assistance is a strong feasibility. Its early development will be crucial to opening up the planet.

Up/Down Western/Eastern Pavonis

One of the most specially advantaged pieces of real estate in all the solar system is the very high (15-23 km?) extinct shield volcano Mons Pavonis (“Peacock Mountain”) which sits astride the Martian equator on the Tharsis uplift. Its

gentle western slope is a textbook site for launch track operations of any kind, far better than any of the mountain candidates on Earth (see earlier article this issue).

A launch track is a captive ground-based virtual first stage which shaves major engine, tank, and fuel weight off the remaining mass that has to be accelerated into orbit and subsequently maneuvered.

A Pavonis — Deimos Elevator

On Earth, the idea of a space elevator to a Geosynchronous facility 23,000 miles up using yet-to-be invented filaments of unbelievable tensile strength is an attractive, if very far off, theoretical possibility (Arthur C. Clarke's "Fountains of Paradise). It would reduce the cost of access to space to that of a small electric bill. Such a construct will be much easier (therefore much earlier) to install for an asteroid (like Ceres) where the distance to be covered and gravitational stresses involved will be orders of magnitude less.

On Mars, two assets will hasten the opening of a space elevator: Pavonis Mons and Deimos, a potential elevator-anchoring mini asteroid like body only slightly further out than Mars-synchronous orbit, and conceivably movable into place. But the timetable for such a development will be contemporary with major efforts to terraform (we prefer "rejuvenate") Mars itself into a friendlier place for human habitation.

Relevant Readings From MMM Back Issues

- MMM # 18 SEP '88 "Pavonis Mons"
- MMM # 73 MAR '94, pp. 3-5, "Urbs Pavonis / Peacock Metroplex: *the Site for Mars' Main Settlement.*"
- MMM # 56 JUN '92 "Harbor & Town"



MMM #100 - NOV 1996



The Lure of the Moon's Hidden Covered Valleys

In this Apollo 10 photo of Hyginus Rille in Sinus Medii (central nearside, 5°E, 8°N) are visible a number of "gaps" in the rille. The arrow points to the most prominent of these, about 10 miles long. The only geologically viable explanation is that this "interruption" is an uncollapsed segment of an original lava tube once well over a hundred miles long. Someday such ready-made sanctuaries from the cosmic elements may house the bulk of the Lunan urban population. Much more on pages *below* in this special "Lava Tube" issue of MMM.

**Lava Tubes
Relevant Readings from MMMs Past**

Articles on Lavatubes

- MMM # 25 MAY '89, p 4, "Lava Tubes"
- MMM # 44 APR '91, pp. 2-4, "Oregon Moonbase"
- MMM # 44 APR '91, pp. 5-6, "Ice Caves"
- MMM # 73 MAR '94, pp. 3-5,
"Urbs Pavonis, the Peacock Metroplex:
the Site for Mars' Main Settlement."
- MMM # 93 MAR '96 p 16 "Visit Oregon Moonbase"

Some Articles On Other Relevant Topics

- MMM # 3 MAR '87 p. 10, "A Concrete Moonbase"
- MMM # 5 MAY '87 "LunARchitecture"; "Weather";
"M is for Middoors"
- MMM # 8 SEP '87 "Parkway"
- MMM # 12 p 8 "Welcome to Moonbase" by Ben Bova
- MMM # 15 MAY '88 p. 12 "Sunflower Solar Collector"
- MMM #s 26-29 & 31-33 "Ventures of the Rille People"
LRS prize winning Prinztown Settlement Study (double-vaulted pressurized rille-spanning agricultural village megastructures)
- MMM # 37 JUL '90, p 3, "Ramadas"
- MMM # 50 NOV '91, pp. 6-8 "Hostels, Part IV: Hostel-Appropriate Architectures"
- MMM # 55 MAR '92, pp 4-6 "Xity Plans"
- MMM # 74 APR '94, p 5, "Shielding and Shelter"
- MMM # 89 OCT '95, pp 3-5 "SHELTER on the Moon:
Digging in for longer, safer stays."

**Lava Tubes
Twelve Questions About Lunar**

> **What is a "lavatube"?** How are they formed? A lavatube is a relic of a river of molten lava, self-crusted over on the top as the exposed surface cools, and then at least partially voided out as the lava spreads out eventually on the surface as a sheet.



> **Where do we find them on Earth?** in what kind of terrain? On Earth we find lavatubes in the flanks of shield volcanoes such as Mauna Loa/Kea in Hawaii and Medicine Lake in California. We also find them wherever we have had vast state-sized flood sheets of lava, as in Washington-Oregon, the Deccan flats of southern India, in northeast Siberia, and elsewhere.

> **How sure are we that similar features exist on the Moon?** The lavatube-rich lava plains found on Earth are geologically analogous to the maria or Seas we find on the Moon. On those grounds alone, we would have a high expectation of finding

lunar tubes. But for a second higher order of evidence we also have, in the same type of terrain, long sinuous valleys on the Moon called rilles (the Latin class name is rima). We have found hundreds of these features in orbital photographs and have visited one (Apollo 15's visit to Hadley Rille). The consensus explanation of such features is that they represent collapsed lavatubes. For a third even more convincing order of evidence, some lavatubes are clearly segmented with interrupting stretches of valley-free surface [see the photo on page 1]. These can only be sections of the original lavatube that have not collapsed and remain still intact. Such sections should by themselves be enough to give future lunar developers ecstatic dreams. But if there are partially intact tubes, it is inconceivable that elsewhere, if not nearby, are to be found wholly intact tubes. Lavatubes are a natural concomitant of maria formation on the Moon, and will be common.

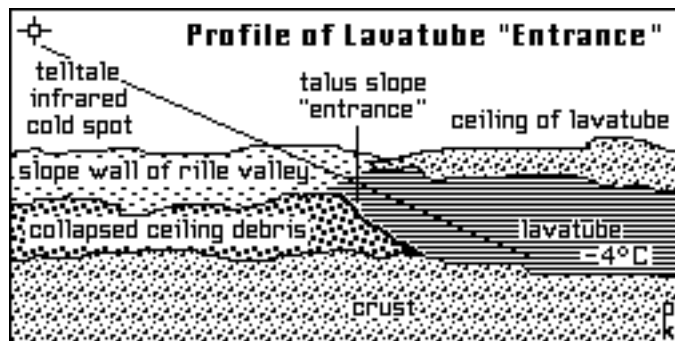

> **Are they near surface objects only?** Those we have direct or indirect evidence of (from rilles) are/ were near surface features. But keep in mind that the maria were filled with a series of lava floodings, and the formation of each successive sheet should have its own lavatubes. On the plus side, lavatubes in deeper layers have been more protected from collapse due to later meteorite bombardment. On the minus side, some, maybe most (a defensible guess for whatever your temperament), were filled up and plugged by later episodes of flooding. Deep tubes are unlikely to be discovered from orbit or from the surface. We could hope to find some of them serendipitously (where tubes in successive levels just happen to cross) by radar soundings taken on the floors of near surface tubes by actual explorers.

> **How might typical lunar lavatubes differ from typical tubes found on Earth?** (1) The formative episodes of lava sheet flooding on the Moon are all very ancient events on the order of 3.5-3.8 Billion years ago. Surviving lavatubes on Earth are all much much younger than that, some only thousands of years old. (2) In addition to being very ancient, lunar lavatubes differ in scale. Probably because of the lower gravity in which they formed (1/6th Earth's) tube-relic rille valleys already observed, photographed and visited run an order of magnitude (ten times) typical terrestrial dimensions in width, ceiling height, and total length. Lunar tubes are BIG. (3) lunar lavatubes have never been exposed to air or water (unless a comet happen to pierce the ceiling and vaporize inside with some of the volatiles freezing out on the tube's still intact inner surfaces - a real "lucky strike"!). Like tubes and caves on Earth, the temperature will be steady, but colder (Earth in general is 50°F warmer than the Moon because of the oceanic-

atmospheric heat sink.)

> **How intact and stable would lunar lavatubes be? How prone to future collapse, total or partial?** Any lavatubes that have survived to this day wholly or partially intact are likely to continue to do so for the rest of time. The vast bulk of major asteroidal bombardment which has pocked the Moon took place in the first billion years of the Moon's history. Lunar lavatubes, not subject to any sort of active geological forces or to any kind of weathering are perhaps the safest, most stable, protected volumes to be found anywhere in the solar system. They are veritable vaults, sanctums, sanctuaries we can bank on - no bet-hedging needed.

> **What aspects of lunar lavatube internal environments are most attractive for human purposes and to what uses might we put them?** (1) "lee" vacuum protected from the micrometeorite rain, from cosmic rays, from solar ultraviolet, and from solar flares, and unlimited volumes of it, is a priceless and odds favoring handicap toward lunar outpost and settlement establishment, expansion, and maintenance. In these conditions, only simple unhardened lighter weight pressure suits need be worn, for much greater safety, comfort, and convenience. Lee vacuum is ideal as well for storage and warehousing and in-vacuum manufacturing. (2) steady temperatures at all times (-4°F), protected both from dayspan heat (+250°F) and nightspan cold (-200 some °F), the "body-heat" of the subsurface Moon being much higher than the "skin" heat of the exposed surface (3) Lunar lavatubes are dust free. The regolith Moondust blanket is the result of eons of micrometeorite bombardment or gardening of the lunar surface. The unexposed surfaces of lunar lavatubes have been protected from all that and, good housekeeping measures adopted and religiously followed, will remain dust-free sanctuaries. Given the insidious invasiveness and machinery- and lung-fouling character of moondust, this asset is a clincher!

For construction purposes, shielding now provided as a transcendental given and dust-control vastly easier, lavatube sites will be much simpler and easier places in which to build. We have only pressurization to provide and maintain within these natural macro-structures.

As a package, lavatube assets effectively remove (squelch, eradicate, nuke) most of the common objections to the Moon as a development and settlement site, reducing worries to lack of around-the-clock sunshine (an engineering energy-storage and usage/scheduling question) and gravity one-sixth Earth normal (as if life hasn't always been able to adapt to anything!).

> **Are there any more special resources we might find in lunar lavatubes here and there as extras?** - Mineralogically, lavatube surfaces and their host terrain will be boring, fairly homogeneous basalt. Other elements, not present in local basalt, can be mined and processed elsewhere and the products made from them brought to the site. But not to be overlooked is the possibility that we have hit the cosmic jackpot with a volatile-rich comet strike of just the right size to puncture, but not collapse, a lavatube. Frozen volatiles would be the prize. These would not be subject to most of the loss mechanisms that will surely operate in polar permashade ice fields (micrometeorite bombardment, solar flares and solar wind,

cosmic rays, splashout from other impacts). To date, the only (and it's inconclusive) teasing evidence we have is an anomalous reading over western Mare Crisium that on first interpretation would seem to indicate subsurface water-ice. This reading has been (but should not be) routinely dismissed as spurious.

> **What lavatube uses are near term, what uses are more challenging and likely to be realized only in the far future?** Warehousing and storage; industrial parks; settlement as opposed to outpost; archiving. All of these can benefit from the use of lavatubes much as we find them, without wholesale modification. The idea of pressurizing tubes for more "terraform" settlement presents a number of enormous hurdles (sealing methods, sealant composition, pressurization stress, importation from Earth of astronomical volumes of nitrogen, etc.) and while in toto vastly easier than wholesale terraforming of a whole surface (e.g. Mars) is still something we will not tackle for some generations perhaps.

> **How much total ready to go protected volume are we talking about?** For political purposes internal to the pro-space movement, let's express our back-of-envelope guesstimate range of the total available volume of intact lunar lavatubes in terms of O'Neill Island III Sunflower space settlement units. That's ready-to-occupy-and-use-NOW (for those without 1-G and 24-hour sunshine hangups - they can wait the generations it will take to build Sunflower units *from scratch* !)

The surface area of the host terrain, the lunar maria, comprise some 17% of lunar surface = 2.5 million square miles - compare with 3 million square miles for continental U.S. Now if (we have to start the argument somewhere!) we assume that available floor and wall terrace surface of intact lavatubes compares to 1/1000th the taking 1/1000th of this aggregate lunar maria surface area, we get 2,500 square miles. This is in our estimate, a very conservative fraction. Counting supposed lavatubes in lower level lava sheets, 1/100th is a fraction that could be closer to reality. That would yield 25,000 square miles, an area comparable to West Virginia.

Subtracting for window strips (as we have for lavatube upper walls and ceilings), an O'Neill cylinder, if ever realized in full ambitious scale, might have 100 square miles of habitable inner surface. Argue about the figures, it won't change the overall picture. We are talking about ready to occupy network of lunar lavatubes that compares to 25 to 250 Island III units. If you are going to hold your breath until these free space oases are built, I can only hope your life expectancy is much more Methuselahn than mine {P. Kokh}.

> **Can we expect to find other similar hidden covered valleys elsewhere in solar system?** Yes, as they seem to be a standard concomitant of lava sheet flooding and of shield volcano formation, we might expect to find lavatubes on Mars, Mercury (the temperature swing refuge would make them hot property), Venus (they would be too hot, and share Venus' over-pressurization), Io (protection from Jupiter's radiation belts), and even on little Vesta..

> **By what Latin class name are such features likely to be referred?** (e.g. rima = rille) Cava, tubus, and ductus are available Latin words. The latter better indicates the mode of

formation.

MMM



Teleo-Spelunking on the Moon

[Reprint of MMM #44, April '91, page 6]

EARTH-BASED SEARCHES FOR LUNAR LAVATUBES

Writing in *Starseed*, the newsletter of Oregon L5 Society, Oregon Moonbase researcher Thomas L. Billings discusses ways to search out lunar lavatubes. Tube openings are hard to spot by camera unless you are right on top of them [but see note below]. While intelligent lunar base siting will require better orbital mapping than provided for the Apollo landings, the best method may be to look "through" the rock. The severe dryness of the lunar surface should make this possible for orbiting radar. (Airborne radar has been used successfully to find lava tubes on the big island of Hawaii.)

To provide deep radar imaging, the antenna diameter must be four times the radar wavelength being used. To penetrate deeply enough we'd need a wavelength of 5-20 meters, meaning an antenna 20-80 meters across! That's a lot of mass to put into orbit along with the ancillary equipment.

Billings suggests a way out. Readings from a number of smaller antennas in an interferometer array can substitute, synthesizing an image. It will be tricky to do this in orbit, and an intercontinental Interferometric is an option Using a 7 meter wavelength, you'd have a 250 meter resolution and a penetration of 70 meters, good enough to detect a convincing sample, given that many tubes are likely to be larger than this.

However, a considerable amount of power will be needed if the signal returning to Earth is to be detectable. Computer algorithms needed to sift signal from noise are getting better. Nor need the search extend beyond a few months, so maybe the expense wouldn't be out of line with the rewards.

TB

Editor's Questions. & Suggestions:

1. Would it be practical to intercept that signal in lunar orbit where it would be stronger?
2. Would Earth-based searches be limited to central nearside?
3. We could use the same instrumentation package to search for tubes on Mars, Mercury, Venus, Io, and Vesta, worlds with shield volcanoes and lava sheets.]

Using Orbiting Infrared Cameras to Find Collaborating Evidence

According To Bryce Walden and Cheryl Lynn York of Oregon Moonbase, orbiting side-looking infrared detectors may on occasion peer into the entrance of a fortuitously oriented lavatube, detecting its characteristic subsurface temperature, clearly distinct from ambient surface readings, in sunshine or out. Illustration in previous article.

MMM

ROBOTIC On Site Exploration & Surveying

by Peter Kokh

We are back on the Moon, to stay it seems, and we've detected a number of lavatubes from orbit, some handy to our first beachhead outpost. The catch is that there are so many things needing priority attention that we cannot afford the manpower and equipment costs to outfit even a single lavatube exploration expedition. But if we don't "go in" and actually explore and survey, how can we plan intelligently to "move inside" in concrete particulars?

Here is a way we can survey in detail all the lavatubes we have detected remotely from photographic evidence, from orbiting radar and infrared equipment. The costs, in comparison to a single limited human expedition, would be negligible.

A **surface crawling drilling rig**, using high resolution orbital radar lavatube location data, finds its initial drill point over an indicated tube site. This rig can be teleoperated or manned. Given the repetitive nature of the tasks involved, a highly automated remote monitored operation will be ideal.

(1) Its first task is to *drill and stabilize* (with a sleeve? with side-wall fusing or sintering lasers?) a hole through the surface and penetrating the lavatube ceiling some tens of meters down. The *hole* might be only a few inches in diameter.

(2) Next the rig winches down through the shaft hole a radar-mapping instrument and/or CCD optical camera down to a height midway between lavatube ceiling and floor (determining that position is the first task of the radar device). Then a flare attached to the bottom of the instrument package is released and dropped. The radar mapper and camera pan 360°, and from near vertical up (zenith) to near vertical down (nadir). The instrument package is retrieved. A latitude/longitude/altitude benchmark is then lowered to the tube floor directly below.

(3) The rig then winches down to the same point a length of fiber optic cable, securing the top end to the collar of the shaft hole. At the top end is a solar light concentrator which passively gathers available dayspan sunshine and channels it into the optic fiber cable. At the bottom end a light diffuser scatters this light in all directions.

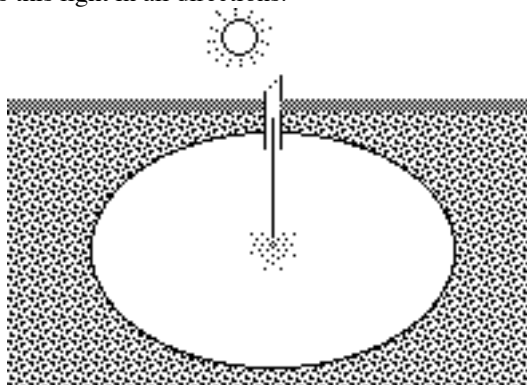

The idea is not to provide future human explorers within the tube with enough light, throughout the surface dayspan period, to find their way around with the naked eye,

but only with *enough light* that they can find their way using off-the-shelf *night-vision goggles*. Of course they will carry battery-pack spotlights to light up areas needing closer inspection, as well as for emergencies e.g. they are forced to stay inside after local sunset on the surface above.

(4) Meanwhile, data from the radar/camera probe is being turned into a contour map of the lavatube's inner surfaces. From this map, it will be clear in which direction the lavatube runs and the location of the next drill hole can be determined, picked so that data from it (and the reach of the left behind "solar flashlight" overlap conveniently).

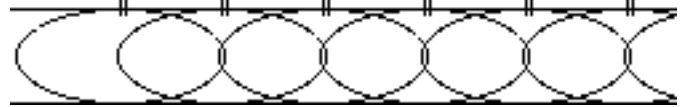

As the instrument package is removed from each successive shaft hole, another passive solar flash light chandelier is installed. On and on until the entire intact lavatube is surveyed from source to outflow. The rig then moves to one end of the next orbitally detected site to be investigated.

The result will be a set of tube surveys and maps from which preliminary rational use scenarios can be put together all prior to commitment of man-hours and man-rated equipment packages. Now, with all of these robotic surveys, safely made, when we do go in to explore or set up shop, we can be sure that the tube section picked is right for the purpose intended, including the offer of adequate expansion room for foreseen development options.

This is the basic idea. Possible embellishments are designing the solar flashlight chandeliers to serve as line-of-sight relays for radio communications by exploring crews, and/or as direct radio antennas to the surface.

If the tube surveyed by the surface-crawling robot drilling rig has already been picked for future development, a "sleeve-bag" of sundry provisions and resupplies could be lowered to the tube floor beside the benchmark prior to sealing the shaft with the solar light fixture apparatus. These provisions would lighten the burden in-tube explorers need carry along. Alternately, the solar light fixtures could be removable if the shaft is needed for lowering provisions or other narrow diameter equipment to the area below it.

This exploration plan will only work, of course, for those near surface tubes that have been sniffed out by our orbiting probes. But that will be an important start! XXXX

Setting into a LAVATUBE

Brainstorming an Early Lavatube Town

by Peter Kokh

Many of our readers will be familiar with the classical Island II "Stanford Torus" space settlement design [Space Settlements: A Design Study, NASA SP-413, 1977]. *Not* counting multiple levels, this ring with an overall diameter of 1800 meters and a torus cross section of 130 meters, has a

circumference of 5.655 km or 3.5 miles and a usable surface area (lower slopes included) of about 50 acres.

With multiple levels, it was estimated some 10,000 people could occupy 106 acres (Manhattan like sardine packing, i.e. quite dense by modern urban standards of c. 5,000 people per square mile = 640 acres.) That seems overdoing it especially since off Earth settlements wherever they are will first and foremost be farming villages: = lots of plants hosting very few people, *not vice versa*.

But thanks to the copious artwork that has accompanied the settlement design studies of the seventies, such a torus does give us an assist in conceptualizing a lavatube settlement. Cut it at one point and unroll it, and you have something comparable, if on the small end, to what we might someday see in lavatubes. The average lavatube is likely to be several times wider than the torus of the NASA study.

interior torus view, art by Pat Hill, IBID, p. 90

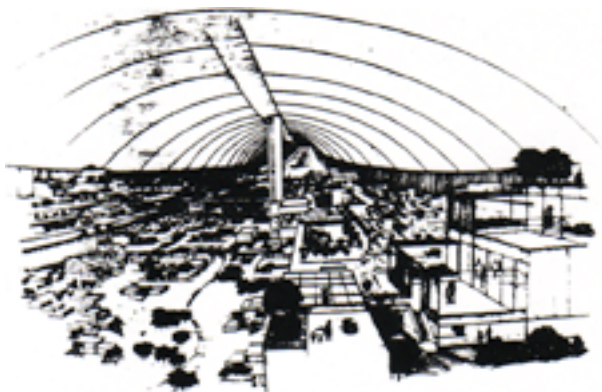

In practical fact, however, this scene gives us more of a goal to hold before us, than a model for feasible near term reality. Sealing a lavatube so as to pressurize it may be easier said than done. If we succeed, filling the immense volume with the usual buffer gas of nitrogen imported from Earth in a 4:1 ratio with lunar oxygen may be budget-busting. But more on this in an article below.

Near-term, pressurized ceiling clearances will have to be kept to a minimum. We will use lavatubes at first not to escape the vacuum, just to escape the deadly cosmic weather that normally comes with vacuum - on the exposed surface.

The tube ceiling vault functions analogously to the Biblical “firmament” protecting Lunans in their hidden valleys (lavatubes) from cosmic radiation etc. and from the otherwise omnipresent dust. Even if the tube is not sealed and pressurized it may be feasible to spray a high albedo coating on the upper walls and ceilings (CaO lime, or Aluminum Oxide or Titanium Dioxide, all producible cheaply and in quantity, are white. The trick is to make an anhydrous “whitewash”. Unfortunately, bluing this inner “sky”, e.g. with locally-producible cobaltous aluminate would be expensive.

Sunshine could be brought in down simple shafts or through optical cable bundles, to be turned on this sky-firmament, thus providing comfortable daylight type ambient light. During nightspan, nuke or fuel-cell powered lamps on the surface could use the same light transmission pathways. Possibly any whitewash material on the upper vault of the tube could have a phosphorescent component for a night span treat. Imagiengineering, it is called.

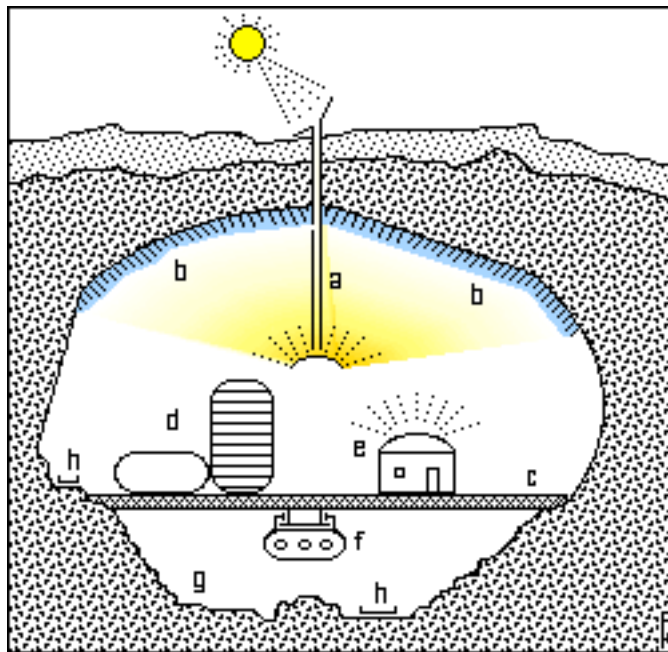

KEY: (a) sunshine access and defuser system; (b) whitewashed “firmament” for best sunlight reflection; (c) “town deck” on tube-spanning beams; (d) assorted structures; (e) “yurt/ hogan” type home with translucent dome to flood interior with firmament-reflected sunshine; (f) monorail transit system; (g) lavatube floor left natural; (h) nature walks.

Instead of grading or even terracing the lavatube floor, it could be left natural with the town built on a spaceframe deck spanning the lavatube shoulder to shoulder. an overhead crane riding rails along the sides of this deck could be useful in constructing/erecting habitat structures. The use of stilt platforms is a possible alternative to the deck span, shoulder to shoulder beams

Elevators to the surface can either be incorporated into “skyscrapers” reaching to the tube ceiling, or be built free-standing to provide great views of the town on the descent from or ascent to the surface.

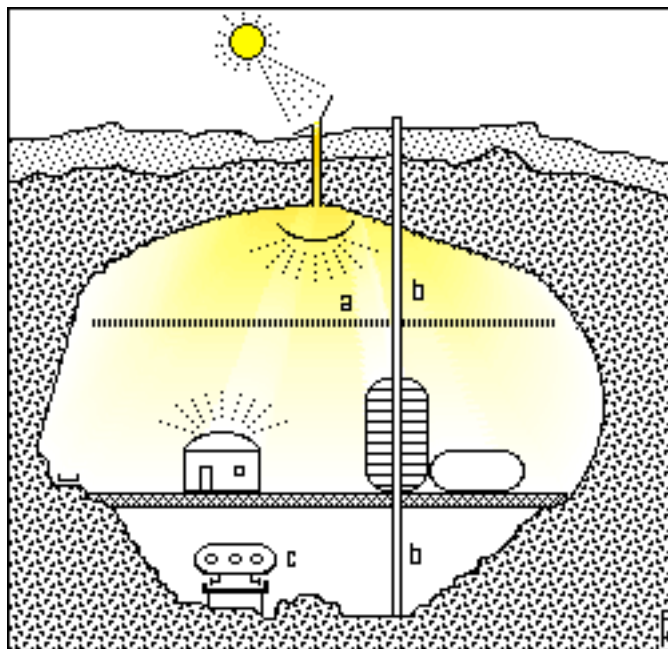

Access to the settlement from the surface is vital. This

can either be by freight and passenger elevator shafts or by a ramp road up the talus slope of a nearby natural entrance. We think the first option will bear the brunt of the traffic.

KEY to illustration above: (a) sunshine access via suspended “daylux” defuser grid instead of coatings; (b) elevator shaft through “skyscraper”; (c) transit system on stiltway over tube floor.

The tubes are given to us dust-free. Thoughtful engineering of tube access systems will help keep them that way. For example, elevators could have their topside terminals opening not onto the dusty surface directly but onto a suspended platform/launchpad complex.

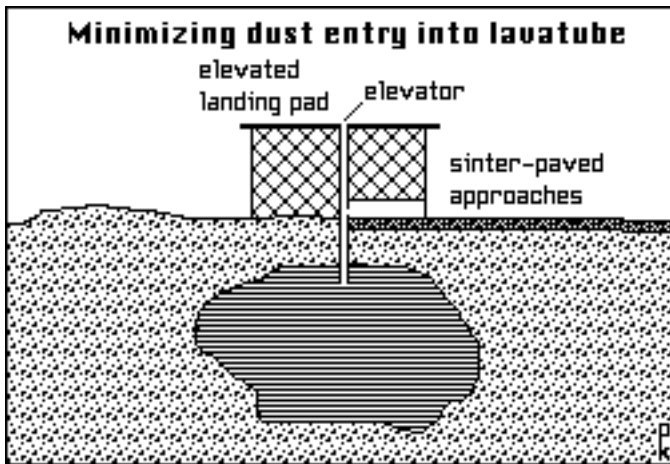

Appearances aside, a vital part of the settle-ment will be out on the surface and building material and component manufacturing out of “pre-mined” regolith, “the” asset of the surface. Once a processing, manufacturing, or gas scavenging position is past the “dust-using” phase, further processing, manufacturing, assembly, or separation can be more safely and more economically done in the lee vacuum environment within the lavatube. Industrial siting decisions will take into account the degree of involvement of solar power and concentrated solar heating. Operations that are electricity driven and not reliant on moon dust, will be the first to move into the tube.

For the lunar architect and contractor, however, freedom from the need to be concerned with shielding is a considerable gain. Tube residences and other structures can have simple windows, and lots of them, through which to behold these nether-world landscapes. The shielded windows of in-surface structures which use mirrors and bent optical paths to thwart radiation, will be a cumbersome relic of pioneer beachhead days, still used where Lunans must live in the regolith blanket surface rather than in provident subsurface voids. Tube structure windows may be characteristically convex, curved in to the pressurized interior, so as to put the panes under compression. Glass and concrete are stronger under compression than under tension. Nor will in tube windows need sacrificial panes.

The subsurface Moonscapes within the lavatubes will be quite different from the surface ones, though sharing one all important, all infecting aspect: their barrenness and sterility. So tubers may share with topside moles the practice of placing plants in front of windows as a psychological filter.

Many architectures are possible. One simple tuber

home plan would be a squat 2-story vertical cylinder section topped off by a convex-paned geodesic dome to let in the tube’s ambient light. The design type might be called the Yurt or Hogan after the Mongolian and Navaho home shapes it resembles.

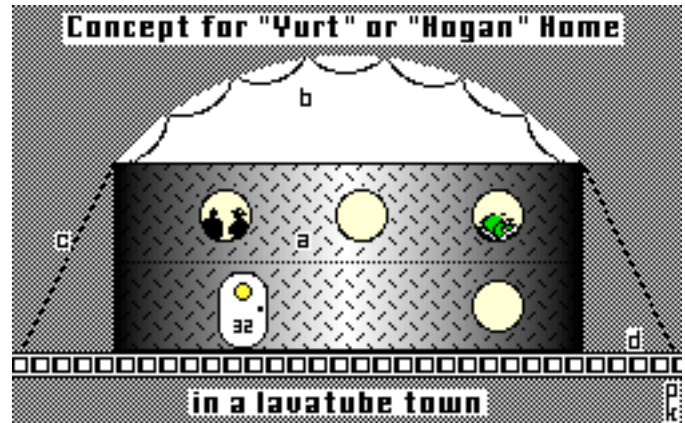

KEY: (a) 2-story vertical cylinder section, bedrooms on the lower level; (b) lunar translation of the geodesic dome for a high translucent ceiling vault over the family room and other common areas including a central garden atrium; glass panes are neither flat nor concave, but convex; (c) cable stays prevent internal pressure from literally “blowing off the roof”; (d) the residential deck of the townsite, leaving the tube floor ungraded.

NOTE: upscaled, the yurt/hogan design will make a fine church, synagogue, or meditation chapel, with the simple use of stained glass convex panes in the roof dome. A shaft of direct sunshine on such a dome would surely help set the mood.

The early lavatube settlement will not be an assembly of individually pressurized buildings, but rather, like the in-surface burrowings, a maze of structures conjoined by pressurized walkways, streets, alleys, and parkways. In the nether-spaces, thoroughfare cylinders can be generously paned with convex windows to flood their interiors with ambient reflected and diffused sunshine and views.

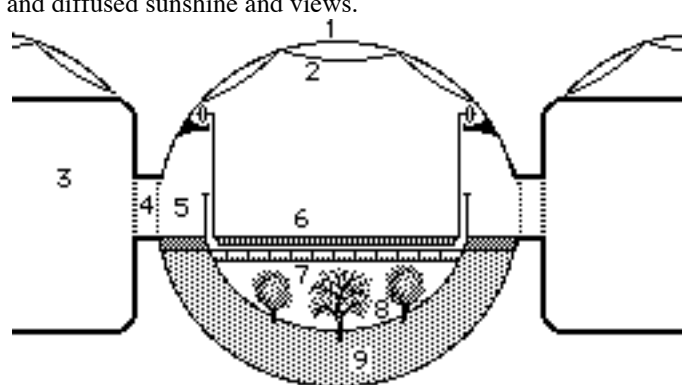

KEY: (1) cylinder section; (2) convex-glass panes to let in ambient reflected sunshine and views; (3) Yurt/hogan style homes opening onto street via entrance tubes (4); (5) pedestrian “sidewalks”; (6) rail-suspended goods delivery platform; (7) “crosswalks”; (8) landscaped, concrete free garden strips; (9) dust-purged, conditioned regolith geoponic soils.

Along with solar access for reflection off coated upper tube surfaces, there can be some sunshine ports that direct intense pools of light downward, say on the convex-paned lunar geodesic domed park squares. Nothing is so soul-renewing as a visit to a pool of strong over-illumination, the feeling

of being outdoors in the undiluted brilliance of the unmediated Sun. Directed sunlight, minus the infrared removed by proper glass filters, will also be needed over agricultural areas.

You can see how construction and architecture in lavatube settlements differ from the other types of in-surface settlements we have discussed before. Initially, there will be a strong reliance on inflatable structures and inflatable-rigid hybrids. Here, in lee vacuum, with no need to cover them with shielding, no vulnerability to micrometeorite puncture or ultraviolet and flare and cosmic ray aging, inflatables will have their heyday. All the same, as the costs of new made on lunar building materials and building components come down, and appropriate construction and erection methods are perfected, the bottom line money consideration will move settlement expansion in that direction.

An intermediate phase may involve the use of inflatable structures as slipforms for cold-casting (poured and sprayed lunar concrete) and arch/vault component placement.

As more generous endowments of nitrogen become financially feasible, larger domes over park space commons will make their entrance, affording a more generous "mid-doors" and the more obvious comfort of luxuriant flora and fauna, plants and urban wildlife.

Meanwhile, in the lee vacuum but visible out the abundant windows of lavatube structures will be other extensions of the settlement: sculpture gardens and Japanese style rock landscaping. Electronic displays on the tube walls, even something reminiscent of drive-in theaters, or should we say through-the-windshield theaters? Backlit murals on glass can infuse the citizens with the dream of a Green Luna, not altogether out of reach. And I'm sure sooner or later we'll see some gross examples of tagging by artistically inclined youth without direction or access to approved ways of expression.

Nature walks can educate citizens on the fine points of lunar geology, variations in lavatube textures and formation.

The lavatube settlement will not be a solitary community. To provide around the clock manning of industrial and agricultural facilities owned in common, a string of 3 villages with staggered day/night lighting (the solar access ports can be shuttered after all) will provide a succession of prime work time day shifts. A trio of villages can be separated by some distance along the inside of a lavatube, with intervening light baffle curtains (where convenient bends in the tube route do not offer the same benefit. Mass transit will unit them, and they can share 24 hour around the clock metropolitan facilities and amenities, including schools and parks and other investments that need to earn their peak full-time, or should we say all-time.

Settling the first lavatube should be part of a well-thought out **Outpost Conversion Strategy**. An initial beach-head outpost is succeeded by a surface Construction Camp once a mature set of feasibility experiments leads to the production of on site building materials. Proper site selection will have taken "graduation" to a nearby lavatube into account as an essential ingredient. Finally, after robot exploration and surveying of the proposed first site, will come the erection of lavatube village one, village two, a metro complex, and village three. Along with warehousing, farms, and industrial park sections - a whole mini urban complex.

(Sub)Terraforming Challenges

Challenges of Sealing & Pressurization

by Peter Kokh

While the volumes available in lavatubes are comparable in cross-section to space settlement designs, especially that of "Island Two", they may not be so readily pressurizable. Lavatube walls were not formed as "pressure vessels" and have never been pressurized (except for the possibility of comet puncture and vaporization). Whether they could structurally withstand the expansive stresses of full atmosphere is uncertain. After all, they exist in an ambient vacuum. Deeper lavatubes will have a better chance of maintaining their integrity, more shallow ones a greater chance of "blowing their lid."

Even though lunar lavatubes have come down to us intact through nearly four billion years of time, that does not mean that there are no fractures in their surfaces that could let an atmosphere eke out slowly but inexorably. And those tubes with entrances provided by past section collapse (illustration on page 4), will have to be closed off somehow. Those without open-vacuum entrances can be many miles long. That means they suck up enormous volumes of lunar oxygen and terrestrial nitrogen.

Of the three principal lunar-scarce volatiles, necessary for life, Hydrogen, Nitrogen, and Carbon, it is nitrogen that is most deficient on the Moon in comparison to the quantities we would like to have. But even if the import cost were no problem, or if we find cheaper extraterrestrial sources (the rocks of Phobos for example) there is the question of the sealants needed themselves.

We could use microwaves of laser sweeps to glassify the lavatube inner surfaces, making them impervious to gas transmission. But introduce water and humidity and we have a problem. Water attacks glass over time. Epoxy resin coatings could not be processed from known lunar materials, and in the quantities needed would pose an astronomical cost.

But if water seems to be the problem, it may also be the solution. For if we saturate the lavatube with water vapor, no matter to what level we manage to raise the inner surface temperatures in the tube, at some point in the peripheral rock, water vapor will form a rock-saturated frozen seal against further loss. Water vapor may be self-sealing.

But this brings up another problem which, all the denial in the world notwithstanding, affects space settlement designs as well - the likely prevalence of permafrost, a serious challenge to our biospheric and agricultural visions.

Suppose we solve most of these "engineering challenges". For safety sake, both against possible decompression accidents and biological contamination, we may want to develop a system of sphincters that can pinch shut convenient sections of lavatubes if need ever arises.

Yet the dream of recreating some part of the Earthly paradise is a very strong and persistent and infectious one. In a lot less time than it will take to overcome the challenges of terraforming the Martian surface, we will be able to start terraforming limited lavatube sections. In contrast to the case on Mars, terraforming the Moon's hidden valleys will work to

keep the out-vac surface comparatively pristine. For the Moon's dusty surface which has never known water or air, that is important. An attempt to terraform the surface (it is estimated that an Earth-dense atmosphere would hang around for a few thousand years - and that is practical for human purposes), any such attempt is likely to backfire and create a dust-bowl condition that will last some centuries.

The more modest goal of terraforming lunar lavatubes will be a lot like terraforming O'Neill's Space Settlement structures or Dandridge Cole's hollowed out cigar-shaped asteroids (e.g. Eros).

In H.G. Wells' "First Men on the Moon", we discover a native "Selenite" civilization tucked away in caves within the Moon. The idea is not new, and now it is more timely than ever.

GOALS of an early lavatube terraforming experiment program

We can safely experiment on a small scale, sealing off and pressurizing small sections of tube for transformation into metropolitan centers and village parks. If these special urban facilities failed, it would not interfere with the operation of the rest of the close-pressurized settlement maze.

The next step, tried before we risk pressurizing a whole settlement, might be a lavatube "Natural Park(way)" - Designed as a safety valve and as a bit of Old Earth for those who cannot afford or physiologically risk a trip down the maw-throat of Earth's hexapotent gravity well, our parkway would be visited and toured, but not open to settlement. Here Lunans could appreciate what they might have missed on Earth, and find themselves renewed and inspired to carry forward the great Lunan experiment. Trial biospheres rich in flora and fauna could be developed without risking would-be residents. A place for honeymooners and lovers and students and retirees - for everyone, The Mecca for Lunans.

Next, a more confident, lesson-learned suite of biospheric experiments behind us, we will have the confidence to tackle bigger and better projects. Biospherics could come to Garden Suburbs, whose condo-owners would pay the cost of experimental installations. And why not a tube amusement park?

There is another question here. Creation of a biosphere for our terraformed volume. The go slow experiments above will educate us and give us confidence before we risk citizen lives.

MMM

But perhaps there will be a conscious effort among the first pioneers, for whom lavatube life is something new and untried, to make allusion to hidden valley, subterranean, and submarine places and kingdoms of ancient lore. After all, it will be this aspect, something not yet taken for granted, that will be foremost in their consciousness as they embark on this new adventure.

A dictionary or encyclopedia I have of mythological and fictitious places gives lots of leads, but most of them are obscure. *Pellucidar* (Edgar Rice Burroughs) and all the local place names associated with this fictitious region will be a prime source. Then there are the submarine legends like Atlantis - after all, lavatubes lie beneath the congealed waves of ancient lava seas. And then there are the hidden valley stories like *Shangri-la*. *Shangri-luna*, anyone?

Once the novelty wears off, lavatube and lavatube settlement names are more likely to come from nearby surface features (rilles, craters, etc.).

"Co-names" might include Depths, Nethers, Cloisters, Retreat, Lair, Anchorage, Haven, Warren, Trove, Sanctuary, Sanctum, Burrow, Hollow, Grotto, Lower-, Nether-, -neath, and similar descriptive choices.

MMM

The Dennis Cripps Cartoon



The MMM Editor boarding the Moonship for Luna City

On Completing the First Ten Years of MMM

Someone in the Artemis Society asked me, now that with the next issue, MMM #101, we'd be celebrating our 10th anniversary of continuous publication, where I'd like to see us, and myself in another 10 years, on the eve of publishing MMM #201, the 20th anniversary issue. Without hesitation, I said that it was my dream to publish that issue on the Moon.

Here it is, January 11, 2006, just after our 19th anniversary, and the only way we are going to get to the Moon in time to publish #201 from Luna City, is aboard an alien UFO!

But I feel good, in the interim, to have completed archiving all the timeless articles from the first ten years. I want to extend the MMM Classics through #140 (the first 14 years) as there will be individual pdf files from there on.

I'm having a very rewarding blast! Peter Kokh

"Down Inside" Civilization & Culture

by Peter Kokh

Part I: Naming Lavatube Settlements

People pick place names for all sorts of reasons: to remember a home town or country, in honor of a fellow pioneer who did not survive the transplantation journey, for a nearby geographic or geologic feature, for a character in a book the leader happened to be reading. The list or rationales is endless. It will be no different on the Moon.