

GDC-ASP79-001

(NASA-CR-173024) LUNAR RESOURCES
UTILIZATION FOR SPACE CONSTRUCTION. VOLUME
2: STUDY RESULTS Final Report, Apr. 1978 -
Feb. 1979 (General Dynamics/Convair) 478 p

~~883-78477~~

883-78478

Unclas

00/12 15124

LUNAR RESOURCES UTILIZATION FOR SPACE CONSTRUCTION

FINAL REPORT
VOLUME II • STUDY RESULTS

CONTRACT NO. NAS9-15560
DRL NO. T-1451
DRD NO. MA-677T
LINE ITEM NO. 4

30 April 1979

Submitted to
National Aeronautics and Space Administration
LYNDON B. JOHNSON SPACE CENTER
Houston, Texas 77058

Prepared by
GENERAL DYNAMICS CONVAIR DIVISION
P.O. Box 80847
San Diego, California 92138



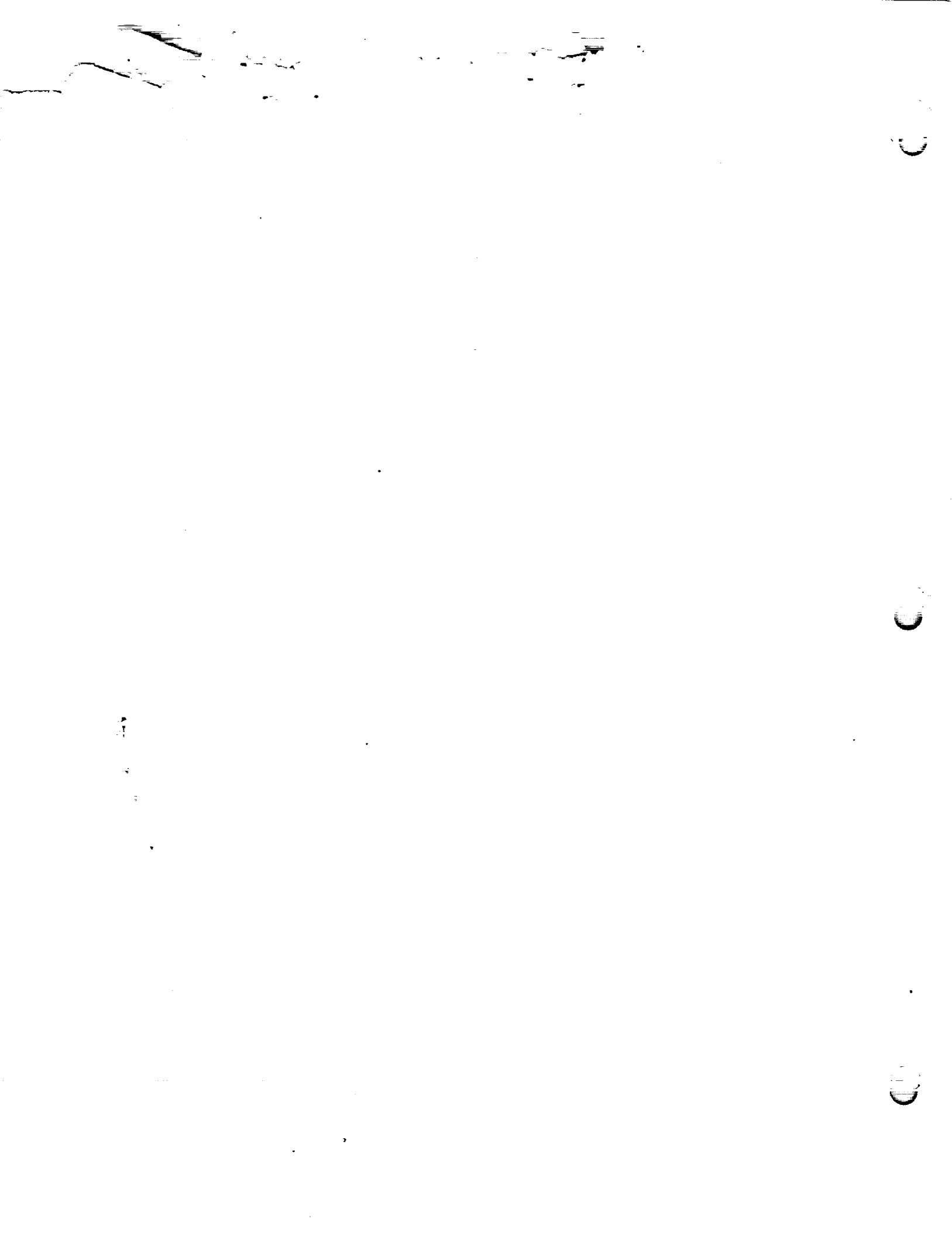

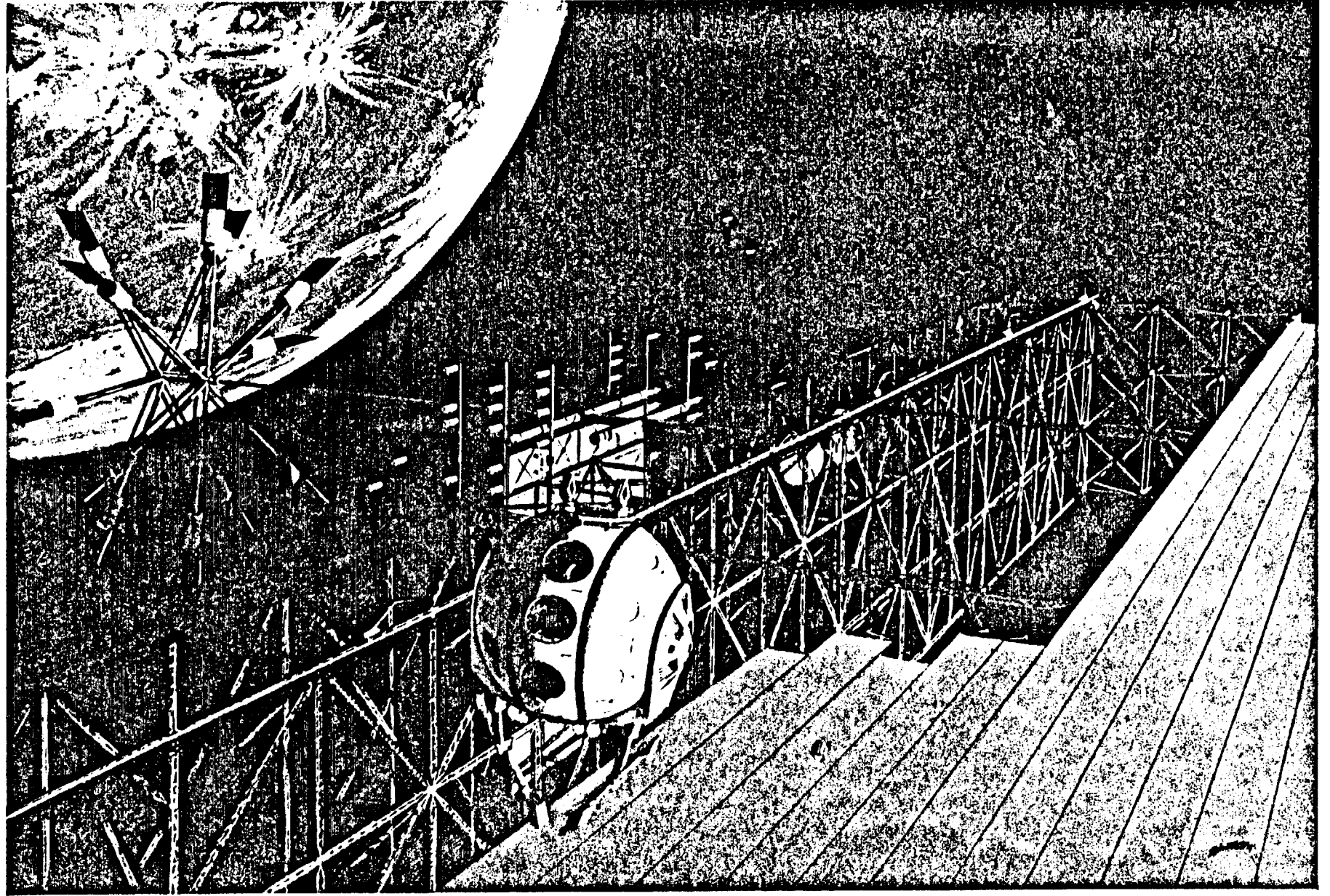



FOREWORD

This final report was prepared by General Dynamics Convair Division for NASA/JSC in accordance with Contract NAS9-15560, DRL No. T-1451, DRD No. MA-677T, Line Item No. 4. It consists of three volumes: (I) A brief Executive Summary; (II) a comprehensive discussion of Study Results; and (III) a compilation of Appendices to further document and support the Study Results.

The study results were developed from April 1978 through February 1979, followed by preparation of the final documentation. Reviews were presented at JSC on 18 October 1978 and 21 February 1979.

Participants who significantly contributed to this study include General Dynamics Convair personnel, a materials processing and manufacturing consultant, and five technical reviewers who are nationally recognized authorities on lunar materials and/or space manufacturing.

General Dynamics Convair

Ed Bock	— Study Manager
Mike Burz	— Transportation Analysis
Lane Cowgill	— Trajectory Analysis
Andy Evancho	— Economic Analysis
Bob Risley	— Economic Analysis
Charley Shawl	— Transportation Systems
Joe Streetman	— Transportation Systems
Maridee Petersen	— Typing

Consultant

Abe Hurlich	— Material Processing & Manufacturing (Retired Manager of Convair's Materials Technology Department and past national president of the American Society for Metals.)
-------------	---

Technical Reviewers

Dr. Jim Arnold	— University of California at San Diego
Gerald Driggers	— Southern Research Institute
Dr. Art Dula	— Butler, Binion, Rice, Cook & Knapp
Dr. John Freeman	— Rice University
Dr. Gerry O'Neill	— Princeton University

In addition to these participants, useful supportive information was obtained from two complementary study activities, from personnel at NASA's Johnson Space Center and Lewis Research Center, and from many academic and industrial researchers who are involved with development of manufacturing processes which may be especially suited for in space use.

- Contract NAS09-051-001 "Extraterrestrial Materials Processing and Construction" being performed by Dr. Criswell of LPI under the direction of JSC's Dr. Williams.
- Contract NAS8-32925 "Extraterrestrial Processing and Manufacturing of Large Space Systems" being performed by Mr. Smith of MIT under the direction of MSFC's Mr. von Tiesenhausen.
- Earth Baseline Solar Power Satellite costing information from Mr. Harron, Mr. Whittington, and Mr. Wadle of NASA's Johnson Space Center.
- Ion Electric Thruster information for argon and oxygen propellants provided by Mr. Regetz and Mr. Byers of NASA's Lewis Research Center.
- Electron Beam Vapor Deposition of Metals Information from Dr. Schiller of Forschungsinstitut Manfred Von Ardenne, Dresden, and Dr. Bunshah of UCLA, plus others.
- Solar Cell Manufacturing Information from Mr. Wald of Mobile Tyco Solar Energy Corp., Mr. Minnucci and Mr. Younger of SPIRE Corp., and Mr. Dubik of Schott Optical Glass Co., plus others.
- Glass Manufacture Using Lunar Materials Information from Dr. MacKenzie of UCLA.

The study was conducted in Convair's Advanced Space Programs department, directed by J. B. (Jack) Hurt. The NASA-JSC COR is Earle Crum of the Transportation Systems Office, under Hubert Davis, Manager.

For further information contact:

Earle M. Crum
National Aeronautics and Space Administration
Lyndon B. Johnson Space Center
Transportation Systems Office, Code ER
Houston, Texas 77058

(AC713) 483-3083

Edward H. Bock
General Dynamics Convair Division
Advanced Space Programs, 21-9500
P. O. Box 80847
San Diego, California 92138

(AC714) 277-8900 x2510

TABLE OF CONTENTS

<u>Section</u>	<u>Page</u>	
1	INTRODUCTION	1-1
1.1	BACKGROUND	1-1
1.2	LUNAR RESOURCES UTILIZATION CONCEPT	1-2
1.3	STUDY SCOPE	1-3
1.4	OBJECTIVES	1-3
1.5	VOLUME II ORGANIZATION	1-4
2	COMPARISON METHODOLOGY AND CRITERIA (TASK 5.1)	2-1
2.1	STUDY GUIDELINES	2-1
2.2	EVALUATION CRITERIA	2-7
2.3	FIGURES OF MERIT	2-8
2.4	COMPARISON METHODOLOGY	2-12
	2.4.1 Comparison Approach	2-15
3	MATERIAL REQUIREMENTS AND SCENARIO DEVELOPMENT (TASK 5.2)	3-1
3.1	GROUNDRULES AND ASSUMPTIONS	3-2
3.2	DEVELOPMENT OF LOW SCENARIO TOTAL MATERIAL REQUIREMENTS	3-3
3.3	PRELIMINARY ESTIMATE OF NOMINAL MATERIAL THRESHOLD	3-6
3.4	SATELLITE MATERIAL REQUIREMENTS (EARTH RESOURCES)	3-14
3.5	SATELLITE MATERIAL REQUIREMENTS (LUNAR RESOURCES)	3-21
	3.5.1 Characterization of SPS Earth Material Requirements	3-21
	3.5.2 Lunar Resource Material Substitution	3-22
	3.5.3 Evaluation of Substitute Lunar Materials	3-27
	3.5.4 Lunar Resource SPS Material Requirements	3-31
4	LUNAR UTILIZATION SYSTEM CONCEPTS DEFINITION (TASK 5.3)	4-1

TABLE OF CONTENTS (cont'd)

<u>Section</u>	<u>Page</u>
4.1 DEFINITION OF ALTERNATIVE LRU IMPLEMENTATION OPTIONS	4-3
4.2 EARTH MATERIAL REQUIREMENTS (EMR) & LRU CONCEPTS DEVELOPMENT	4-10
4.2.1 Concept A - Earth Baseline	4-15
4.2.2 Concept B - Lunar Mass Driver Catapult	4-17
4.2.3 Concept C - Lunar LH ₂ /LO ₂ Chemical Rocket	4-19
4.2.4 Concept D - Lunar Derived Rocket	4-21
4.2.5 EMR Sensitivity Analyses	4-23
4.3 EMR COMPARISON AND PRELIMINARY CONCEPT ASSESSMENT	4-27
4.4 LUNAR MATERIALS PROCESSING AND MANUFACTURING	4-30
4.4.1 The Lunar Surface - Composition and Characteristics	4-32
4.4.2 Mining and Beneficiation of Lunar Regolith	4-37
4.4.3 Extraction of Materials From Lunar Regolith	4-42
4.4.4 Manufacture of Stock Materials	4-51
4.4.5 Manufacture of Parts	4-72
4.4.6 Component Assembly	4-73
4.4.7 Materials Losses During Processing and Manufacture	4-78
4.4.8 Earth Materials Requirements	4-84
4.5 LRU INFRASTRUCTURE ELEMENT DEFINITION	4-89
4.5.1 Propellant Depots	4-89
4.5.2 Habitats	4-106
4.5.3 Power Systems	4-138
4.6 LRU TRANSPORTATION ELEMENT DEFINITION	4-147
4.6.1 Vehicle and Fleet Sizing	4-150
4.6.2 Vehicle Descriptions	4-157
4.6.3 Vehicle Comparison and Other Considerations	4-183
4.6.4 Vehicle Requirements Summary	4-188
4.7 LRU MATERIAL CHARACTERIZATION	4-190
4.8 LRU START-UP LOGISTICS	4-196

TABLE OF CONTENTS (cont'd)

<u>Section</u>	<u>Page</u>
4.8.1 Start-Up Mass Estimates	4-197
4.8.2 Start-up Period and Fleet Sizing Estimates	4-214
4.8.3 Earth Launched Payload Comparison	4-217
4.9 UPDATED IN-SPACE PERSONNEL REQUIREMENTS ESTIMATE	4-219
5 ECONOMIC ANALYSES (TASKS 5.3, 5.4 & 5.6)	5-1
5.1 EARTH MANUFACTURED SPS BASELINE	5-4
5.1.1 Cost Work Breakdown Structure	5-4
5.1.2 SPS Baseline Life Cycle Cost	5-5
5.2 LUNAR RESOURCE UTILIZATION ELEMENT COSTS	5-8
5.3 TOTAL PROGRAM COST OF THE LRU OPTIONS	5-15
5.3.1 Costs	5-15
5.3.2 Nominal Economic Thresholds	5-31
5.3.3 Cost Reconciliation	5-31
5.4 COST UNCERTAINTY ANALYSIS	5-44
5.4.1 Methodology	5-45
5.4.2 Economic Thresholds	5-50
5.4.3 Threshold Sensitivity to Manufacturing Costs	5-58
5.4.4 Implications of the Uncertainty and Sensitivity Analyses	5-63
5.4.5 Key Driver Parameters	5-65
5.5 FUNDING SPREAD PROFILES/PRESENT VALUE ANALYSIS	5-67
5.5.1 Funding Profiles	5-69
5.5.2 Present Value	5-78
6 PRELIMINARY DECISION ANALYSIS (TASK 5.5)	6-1
6.1 PARALLEL DEVELOPMENT PROGRAM DEFINITION	6-2
6.2 PROGRAM DEVELOPMENT SCHEDULES	6-9
6.3 ACHIEVEMENTS NEEDED TO JUSTIFY FUNDING	6-11

TABLE OF CONTENTS (cont'd)

<u>Section</u>		<u>Page</u>
7	RECOMMENDATIONS (TASK 5.7)	7-1
	7.1 RECOMMENDATIONS FOR FURTHER WORK	7-2
	7.1.1 System Study Recommendations	7-3
	7.1.2 Technology Studies	7-8
	7.2 TASK ASSESSMENT AND SCHEDULING	7-11
	7.3 LRU SHUTTLE TECHNOLOGY EXPERIMENTS	7-12
8	REVIEWER CONTRIBUTIONS	8-1
	8.1 REVIEWER RESUMES	8-2
	8.2 DR. ARNOLD'S COMMENTS	8-10
	8.2.1 Significant Contributions Made by Study	8-10
	8.2.2 Assessment of Study Usefulness and Applicability	8-11
	8.2.3 Expanded Comments Concerning Dr. Arnold's Specific Areas of Interest	8-12
	8.3 MR. DRIGGERS' COMMENTS	8-20
	8.3.1 Significant Contributions Made by Study	8-20
	8.3.2 Evaluation of Study Results; Criticisms	8-21
	8.3.3 Expanded Information Concerning Mr. Driggers' Specific Area of Interest	8-21
	8.4 DR. DULA'S COMMENTS	8-31
	8.4.1 Significant Contributions Made by Study	8-31
	8.4.2 Assessment of Study Usefulness and Applicability	8-32
	8.4.3 Expanded Comments Concerning Dr. Dula's Specific Area of Interest	8-33
	8.5 DR. FREEMAN'S COMMENTS	8-36
	8.5.1 Significant Contributions Made by Study	8-36
	8.5.2 Evaluation of Study Results; Criticisms	8-38
	8.5.3 Expanded Comments Concerning Dr. Freeman's Special Area of Interest	8-39
	8.6 DR. O'NEILL'S COMMENTS	8-44
	8.6.1 Significant Contributions Made by Study	8-44
	8.6.2 Assessment of Study Usefulness and Appli- cability - Limitation of Starting Assumptions	8-45
	8.6.3 Evaluation of Study Results; Criticisms	8-52

LIST OF FIGURES

<u>Number</u>		<u>Page</u>
2-1	Average unit SPS costs.	2-10
2-2	Lunar resource utilization cost projections from previous work.	2-14
2-3	Comparison approach.	2-16
2-4	Example steady-state cargo transfer scenario for a LRU concept with conventional chemical Lunar Transfer Vehicle	2-18
2-5	Iterative approach for developing representative LRU concepts.	2-19
2-6	Initial nominal economic comparison of LRU and Earth Baseline concepts.	2-21
2-7	Comparison of LRU and Earth Baseline concepts including cost uncertainties.	2-22
3-1	Lunar material requirements development.	3-1
3-2	Preliminary estimate of nominal threshold point.	3-13
3-3	Steps for lunar material substitution.	3-21
4-1	Four representative implementation options for in-space manufacturing of large structures.	4-5
4-2	Concept A - Earth Baseline SPS.	4-16
4-3	LRU Concept B - Lunar Mass Driver Catapult.	4-17
4-4	LRU Concept B - Mass Driver Catapult.	4-18
4-5	LRU Concepts C&D - Lunar chemical rockets.	4-19
4-6	LRU Concept C - LO ₂ /LH ₂ lunar transfer vehicle.	4-20
4-7	LRU Concept D - Lunar derived rocket.	4-22
4-8	Percent of SPS derived from lunar resources.	4-24
4-9	Processing and manufacturing scope.	4-31
4-10	Mining and beneficiation.	4-40
4-11	Proposed lunar material melting facility.	4-47
4-12	Aluminum sheet production, continuous vapor deposition.	4-56
4-13	Foamed glass production, continuous automated process for structural and waveguide components.	4-65
4-14	Solar cell module production.	4-77
4-15	Infrastructure elements.	4-90
4-16	LRU element data sheet—LEO propellant depot.	4-95
4-17	Flexible container configuration.	4-97
4-18	LRU element data sheet—Lunar oxygen liquefaction facility.	4-101
4-19	LRU element data sheet—SMF oxygen liquefaction facility.	4-103
4-20	Configuration summary.	4-105
4-21	LRU element data sheet—LEO modular space station.	4-110
4-22	Galactic radiation protection for deep space habitats.	4-113

LIST OF FIGURES (cont'd)

<u>Number</u>		<u>Page</u>
4-23	Solar flare radiation protection for deep space habitats.	4-115
4-24	LRU element data sheet—Temporary shelter.	4-120
4-25	LRU element data sheet—Small lunar base habitat.	4-122
4-26	Configuration of lunar base habitat modules constructed from ET hydrogen tanks.	4-126
4-27	Conceptual geometric arrangement for 1200 person lunar base using ET LH ₂ tanks.	4-127
4-28	LRU element data sheet—Large lunar base habitat.	4-129
4-29	Proposed configuration for modular 1 g SMF habitat employing ET hydrogen tanks.	4-132
4-30	LRU element data sheet—SMF habitat.	4-134
4-31	Habitat configuration summary.	4-138
4-32	LRU element data sheet—Lunar nuclear power plant.	4-145
4-33	LRU element data sheet—Space photovoltaic power plant.	4-146
4-34	LRU transportation benefit.	4-148
4-35	Transportation routes and vehicle requirements.	4-150
4-36	LRU element data sheet—HLLV.	4-158
4-37	LRU element data sheet—PLV.	4-159
4-38	LRU element data sheet—POTV (Earth Baseline).	4-161
4-39	LRU element data sheet—COTV (Earth Baseline).	4-163
4-40	LRU element data sheet—Passenger and crew control module.	4-164
4-41	Earth launch vehicle comparative assessment.	4-165
4-42	LRU element data sheet—SDV.	4-166
4-43	LRU element data sheet—Space Shuttle.	4-168
4-44	LRU element data sheet—POTV (LRU concepts).	4-169
4-45	LRU element data sheet—COTV (LRU concepts).	4-171
4-46	LRU element data sheet—LTV.	4-174
4-47	LRU element data sheet—LDR.	4-175
4-48	LRU element data sheet—Mass driver catapult.	4-177
4-49	LRU element data sheet—Mass catcher.	4-178
4-50	LRU element data sheet—Terminal tug.	4-180
4-51	LRU element data sheet—PLTV.	4-184
4-52	COTV assessment.	4-186
4-53	Lunar material launch technique.	4-187
4-54	Material characterization for LRU Concept B.	4-193
4-55	Material characterization for LRU Concept C.	4-195
4-56	LRU Concept B start-up payload requirements.	4-212
4-57	LRU Concept C start-up payload requirements.	4-213
4-58	LRU Concept D start-up payload requirements.	4-213

LIST OF FIGURES (cont'd)

<u>Number</u>		<u>Page</u>
4-59	Earth launched payload comparison.	4-218
5-0	Economic analysis task flow.	5-3
5-1	Summary cost work breakdown structure.	5-5
5-2	Development cost work breakdown structure.	5-6
5-3	Production cost work breakdown structure.	5-7
5-4	Operations cost work breakdown structure.	5-8
5-5	Nominal economic thresholds for LRU Concepts B, C and D.	5-32
5-6	Development cost comparison.	5-34
5-7	Production/operations cost comparison.	5-35
5-8	Earth Baseline manufacturing chain.	5-38
5-9	LRU SPS manufacturing chain.	5-39
5-10	LRU Concept B threshold with $\pm 3\sigma$ uncertainty ranges.	5-51
5-11	LRU Concept C threshold with $\pm 3\sigma$ uncertainty ranges.	5-52
5-12	LRU Concept D threshold with $\pm 3\sigma$ uncertainty ranges.	5-53
5-13	Iterative process required to determine crossover as a function of cost uncertainty ranges.	5-55
5-14	Identification of maximum crossover points for various cost uncertainty ranges.	5-56
5-15	Nominal economic thresholds if Earth Baseline and LRU Concept manufacturing costs are equal.	5-60
5-16	LRU Concept B economic threshold with $\pm 3\sigma$ uncertainty ranges.	5-61
5-17	Crossover points if Earth Baseline and LRU concepts have equal manufacturing costs.	5-62
5-18	Annual cost distribution curves.	5-70
5-19	Earth Baseline funding spread schedule.	5-72
5-20	Funding schedule - typical for LRU Concepts B, C & D.	5-73
5-21	Estimated annual expenditures - Earth Baseline.	5-74
5-22	Estimated annual expenditures - LRU Concept B.	5-75
5-23	Estimated annual expenditures - LRU Concept C.	5-76
5-24	Estimated annual expenditures - LRU Concept D.	5-77
5-25	Cumulative present value comparison of costs at a 7% discount rate.	5-79
5-26	Cumulative present value comparison of costs at a 10% discount rate.	5-80
5-27	Cumulative present value comparison of costs at a 15% discount rate.	5-81

LIST OF FIGURES (cont'd)

<u>Number</u>		<u>Page</u>
6-1	Parallel development programs for Earth Baseline and LRU satellite construction.	6-3
6-2	Example Earth Baseline SPS program plan - summary schedule	6-12
6-3	Example lunar resource utilization SPS program plan - summary schedule.	6-13
6-4	Example lunar resource utilization SPS development schedule.	6-15
7-1	Proposed schedule for system study tasks.	7-15
7-2	Proposed schedule for technology development tasks.	7-16
8-1	Timeframe chart for treaties and organizations	8-37
8-2	The Photoklystron	8-42

LIST OF TABLES

<u>Number</u>		<u>Page</u>
1-1	Lunar resources utilization study tasks.	1-4
2-1	LRU manufacturing options.	2-5
2-2	Candidate evaluation criteria.	2-8
2-3	Transportation cost contributors.	2-11
2-4	Manufacturing cost contributors.	2-11
2-5	Judgemental considerations.	2-11
2-6	Alternative construction concepts.	2-19
3-1	Candidate satellites for the low material requirements scenario.	3-4
3-2	Information employed for estimating satellite quantities.	3-5
3-3	Low material requirements scenario does not include satellite power stations.	3-7
3-4	SPS development/startup cost comparison.	3-9
3-5	Summer study cost adjustments.	3-10
3-6	Adjusted summer study production costs for one SPS per year.	3-11
3-7	SPS unit cost comparison (1977 \$B).	3-11
3-8	10 GW satellite system materials requirements.	3-15
3-9	SPS earth material requirements summary.	3-16
3-10	Estimated earth material requirements for modified low scenario satellites other than SPS.	3-17
3-11	Low scenario earth material requirements summary.	3-16
3-12	Comparison of low scenario material requirements.	3-19
3-13	SPS earth material requirements mass breakdown.	3-23
3-14	SPS earth material mass ranking and application.	3-24
3-15	Recommended lunar material substitutions.	3-26
3-16	Compilation of SPS substitute lunar materials.	3-28
3-17	Assessment of lunar material substitutes.	3-29
3-18	Lunar Resource SPS material requirements.	3-32
4-1	Summary of material processing locations for the Earth Baseline and three generalized space manufacturing options.	4-4
4-2	Definition of vehicle performance assumptions.	4-13
4-3	Material requirements sensitivity.	4-26
4-4	Comparison of LRU Concepts and Earth Baseline.	4-28
4-5	Summary LRU Concept comparison with Earth Baseline.	4-28
4-6	Earth & lunar crustal compositions.	4-32
4-7	Percent occurrence of minerals in lunar materials.	4-34
4-8	Lunar materials available.	4-36

LIST OF TABLES (cont'd)

<u>Number</u>		<u>Page</u>
4-9	Materials extraction and manufacturing.	4-38
4-10	Suggested processes for extraction of SPS materials from lunar soils.	4-44
4-11	Aluminum alloys capable of being prepared from lunar materials.	4-53
4-12	Processes for manufacture of aluminum sheet.	4-55
4-13	Iron and steel alloys capable of being made from lunar materials.	4-59
4-14	Processes for manufacture of iron and steel products.	4-61
4-15	Processes for manufacture of fused silica glass sheet.	4-68
4-16	SMF mass and power requirements for stock production and manufacture of SPS parts and assemblies.	4-79
4-17	Lunar and earth material requirements summary; non-recoverable manufacturing losses not considered.	4-80
4-18	Summary of SPS material requirements including non-recoverable losses.	4-81
4-19	Revised SPS mass estimate for construction with lunar materials.	4-82
4-20	Stock material requirements for SPS obtained from lunar resources.	4-83
4-21	Cooling water requirements.	4-86
4-22	Material requirements other than water.	4-87
4-23	Requirements for materials other than fluids.	4-88
4-24	Earth material requirements for SPS production.	4-88
4-25	Depot propellants.	4-92
4-26	SDV launched propellant delivery modules.	4-93
4-27	LEO depot mass estimate.	4-94
4-28	Depot sizing constants.	4-99
4-29	Lunar oxygen liquefaction equipment mass estimate.	4-100
4-30	SMF oxygen liquefaction equipment mass estimate.	4-102
4-31	Propellant facility sizing summary.	
4-32	Habitats are grouped by three major parameters.	4-106
4-33	Habitat design requirements are sensitive to LRU systems concepts.	4-108
4-34	LEO modular space station radiation protection.	
4-35	Shielding requirements for deep space habitats.	4-116
4-36	Solar flare shelter size and mass estimates.	4-117
4-37	Total habitat mass as a function of crew stay time.	4-118
4-38	Initial consumables for 12 person lunar base.	4-123
4-39	1200 person lunar base habitat mass estimate.	4-130
4-40	1500 person SMF habitat mass estimate.	4-135

LIST OF TABLES (cont'd)

<u>Number</u>		<u>Page</u>
4-41	Habitat comparison.	4-137
4-42	Habitat sizing summary.	4-137
4-43	Power system summary (1990 technology).	4-139
4-44	Weight summary for a 350 MWe nuclear power system.	4-141
4-45	Weight summary for a 350 MWe solar power system.	4-143
4-46	LRU concept power requirements.	4-144
4-47	Power plant sizing.	4-144
4-48	Sites assumed for definition of LRU transportation systems.	4-149
4-49	Concept A vehicle and fleet sizing.	4-152
4-50	Concept B vehicle and fleet sizing.	4-153
4-51	Concept C vehicle and fleet sizing.	4-155
4-52	Concept D vehicle and fleet sizing.	4-156
4-53	Ion electric COTV characteristics.	4-172
4-54	Catcher/Terminal tug options.	4-182
4-55	Vehicle requirements comparison.	4-189
4-56	Lunar material requirements per 10 GW SPS.	4-191
4-57	Concept B start-up phase.	4-198
4-58	Concepts C&D start-up phase.	4-199
4-59	Concept B start-up estimate.	4-202
4-60	Concept C start-up estimate.	4-205
4-61	Concept D start-up estimate.	4-208
4-62	Start-up mass estimate for Concept B.	4-211
4-63	Start-up Mass Estimate for Concept C.	4-211
4-64	Start-up Mass Estimate for Concept D.	4-212
4-65	Start-up Mass Summary Comparison.	4-214
4-66	Start-up operations for Concept B.	4-215
4-67	Start-up operations for Concept C.	4-215
4-68	Start-up operations for Concept D.	4-215
4-69	Concept B personnel estimate.	4-221
4-70	Concepts C and D personnel estimates.	4-223
4-71	LRU in-space personnel requirements.	4-224
5-1	RDT&E phase definitions	5-9
5-2	Production phase definitions.	5-10
5-3	Operations phase.	5-11
5-4	Earth Baseline life cycle cost.	5-12
5-5	LRU Option B life cycle cost.	5-18
5-6	LRU Option C life cycle cost.	5-22
5-7	LRU Option D life cycle cost.	5-26
5-8	Summary program cost comparison.	5-30
5-9	Major cost differences between the Earth Baseline and LRU Concept B.	5-36

LIST OF TABLES (cont'd)

<u>Number</u>		<u>Page</u>
5-10	Confidence level criteria for cost uncertainty estimates.	5-46
5-11	Cost element confidence levels and uncertainty range estimates.	5-47
5-12	Program phase cost uncertainty ranges.	5-49
5-13	Ranking of cost contributors.	5-66
5-14	Present values of the alternatives.	5-82
6-1	System element development comparison.	6-9
6-2	Critical LRU development requirements.	6-15
7-1	System study task assessment.	7-13
7-2	Technology development task assessment.	7-14
7-3	LRU shuttle technology experiments.	7-17

LIST OF ACRONYMS

ACS	Attitude Control System
COR	Contracting Officers Representative
COTV	Cargo Orbital Transfer Vehicle
CRES	Corrosion Resistant Steel
CTV	Cargo Transfer Vehicle
DOE	Department of Energy
DRD	Data Requirement Description
DRL	Data Requirements List
ECLSS	Environmental Control & Life Support System
EMR	Earth Material Requirements
ET	External Tank (Space Shuttle)
EVA	Extra Vehicular Activity
GDC	General Dynamics Convair
GEO	Geostationary (or Geosynchronous) Earth Orbit
HLLV	Heavy Lift Launch Vehicle
ISP	Specific Impulse
JSC	Johnson Space Center (NASA)
L ₂	Lagrangian Libration Point Behind Moon
L ₄ or L ₅	Lagrangian Libration Point which Forms an Equilateral Triangle with Earth and Moon
LDR	Lunar Derived Rocket
LEO	Low Earth Orbit
LeRC	Lewis Research Center (NASA)
LLO	Low Lunar Orbit
LMR	Lunar Material Requirements
LPI	Lunar and Planetary Institute
LRU	Lunar Resource Utilization
LS	Life Support
LSS	Large Space Structure
LTV	Lunar Transfer Vehicle
MBE	Molecular Beam Epitaxy
MDRE	Mass Driver Reaction Engine
MIT	Massachusetts Institute of Technology
MPTS	Microwave Power Transmission System
MSFC	Marshall Spaceflight Center (NASA)
NASA	National Aeronautics and Space Administration
OTV	Orbital Transfer Vehicle
PLTV	Personnel Lunar Transfer Vehicle
PLV	Personnal Launch Vehicle

LIST OF ACRONYMS (cont'd)

POTV	Personnel Orbital Transfer Vehicle
RDT&E	Research, Development, Test and Evaluation
RMS	Remote Manipulator System (Space Shuttle)
RPL	Rotary Pellet Launcher
SCB	Space Construction Base
SDV	Shuttle Derived Vehicle
SEP	Solar Electric Propulsion
SMF	Space Manufacturing Facility
SPS	Solar Power Satellite or Satellite Power Station
SRB	Solid Rocket Booster (Space Shuttle)
SSME	Space Shuttle Main Engine
SSTS	Space Shuttle Transportation System
TFU	Theoretical First Unit
TT	Terminal Tug
UCLA	University of California at Los Angeles
WBS	Work Breakdown Structure

ENGLISH CONVERSIONS

1 kilogram (kg)	= 2.205 lb
1 meter (m)	= 39.372 inches = 3.281 ft
1 ton	= 1000 kg = 2205 lb
1 square meter	= 10.76 square feet
1 micrometer (μm)	= 10^{-6} meters = 10^{-3} millimeters
(mm)	= 3.94×10^{-5} inches
$^{\circ}\text{C}$	= $(^{\circ}\text{F}-32) \frac{5}{9}$ = $^{\circ}\text{K}-273^{\circ}$
1 kilometer (km)	= 0.6214 mile
1 square kilometer	= 0.3861 square mile
1 gravitational constant (g)	= 9.806 m/sec^2 = 32.2 ft/sec^2
1 Newton	= 0.2248 lb_f
Specific Impulse (I_{sp})	= $\frac{\text{Newton-second} \left(\frac{\text{N} \cdot \text{s}}{\text{kg}} \right)}{\text{kg}}$
	= 9.806 (ISP in seconds)
Pressure	= N/cm^2 = 0.689 $\text{lb}_\text{f}/\text{in}^2$
1 Pa	= 1 N/m^2

1

INTRODUCTION

1.1 BACKGROUND

During the late 1960's two exciting future space projects involving immense structures were proposed. These two ideas, Solar Power Satellites (SPS) and space settlements, were totally unrelated during their conception and early promotion. The SPS, proposed by Dr. Peter Glaser of A. D. Little, is a multi-kilometer photovoltaic array located in geosynchronous orbit to continuously collect solar energy and beam power to earth via microwaves. Space settlements providing for permanent habitation of large populations (thousands) were proposed by Dr. Gerard O'Neill of Princeton University.

Both proposals suffered from "concept shock" during their initial promotion, since material masses needed for in-space construction of a single 10 GW SPS exceeded the total mass orbited during the Apollo project by two orders of magnitude. Doctors Glaser and O'Neill recognized this and addressed technical questions to prove that their respective concepts were theoretically feasible using current technology.

The oil embargo and resulting energy crisis of 1973 initiated Project Independence, and promoted NASA interest in SPS. NASA brought its Apollo background and Space Shuttle technology to bear on SPS, and developed a credible program for in-space assembly of earth-launched components. Dr. O'Neill also received NASA/OAST help via three summer studies sponsored by Ames Research Center. His construction approach was by necessity more radical; the extremely massive structures required for space settlements demanded that an extraterrestrial material source be developed. Both lunar and asteroidal resources were evaluated for this purpose, and the lunar source selected as the lower risk option due to Apollo sample data. The only major ingredient lacking for space settlement justification was a useful product to provide economic self-sufficiency.

At this point SPS and space settlements merged, since SPS was the only identified product sufficiently massive to support space settlement. Economic analyses conducted under Dr. O'Neill's leadership indicated that SPS construction could be accomplished at lower cost using his space manufacturing approach.

The economic analyses for earth-based SPS and space manufactured SPS were accomplished independently with dissimilar ground rules and assumptions. Therefore, a direct comparison of these existing analyses is not meaningful. One objective of the Lunar Resource Utilization for Space Construction study is to resolve these costing methodology inconsistencies. Further, alternative techniques for accomplishing lunar material utilization will be defined and evaluated in an attempt to discover lower risk space manufacturing methods.

1.2 LUNAR RESOURCES UTILIZATION CONCEPT

The lunar resources utilization (LRU) concept involves use of lunar materials rather than materials obtained from earth for in-space construction projects. In this concept, lunar surface material would be mined, processed to obtain useful elements such as silicon, oxygen, aluminum and iron, and fabricated into satellites capable of providing useful earth services and generating revenues. Lunar resource utilization involves an expanded manned space program regarding activity locations and total in space personnel as compared to an equivalent earth based satellite construction program.

Potential benefits associated with LRU:

- Lower energy requirements for delivery of material from moon to geosynchronous earth orbit (GEO) than from earth to GEO, results in reduced transportation costs.
- Significantly reduced earth material requirements since the majority of construction materials are obtained from the moon. Reduced depletion of earth resources.

- Significantly reduced earth launch vehicle requirements due to lower payload requirements. This results in reduced propellant consumption and atmospheric pollution. Launch vehicle size and flight schedule can also be reduced.
- Economic and social gains accruing from these reduced earth activities, assuming that equivalent revenue generating satellites can be produced with lunar resources.

1.3 STUDY SCOPE

The study developed and compared equivalent LRU and reference earth baseline space construction scenarios to determine the project size needed for LRU to be economically competitive. This project size was identified as the material requirements threshold at which lunar resources utilization may become cost effective. Alternative LRU techniques were developed and evaluated to determine threshold sensitivity to material processing location and lunar material transfer methods.

Assessment included conceptual definition of LRU major system elements, development of element costs, and total program costs. This information was obtained as much as possible from available literature and results of previous and current NASA-industry studies. The study goal was to perform an equitable comparison of LRU concepts with the earth baseline, using compatible ground rules and cost estimating procedures.

1.4 OBJECTIVES

Overall objectives of the lunar resources utilization study are:

- Establish evaluation criteria to compare manufacture of space structures with lunar or earth materials
- Define lunar resource utilization concepts and conduct an initial feasibility assessment
- Establish the material requirements threshold where lunar resource utilization becomes cost effective

- Determine conditions under which a series of decisions to pursue use of lunar materials would be justified
- Prepare plans and recommendations for further work needed to permit a future choice between space manufacturing scenarios

1.5 VOLUME II ORGANIZATION

These objectives were addressed by the seven study tasks identified in Table 1-1. The following sections of this volume are organized by study task for the presentation of results. Each section represents a specific study task, except for Section 5, which combines all economic analyses activities from Tasks 5.3, 5.4 and 5.6.

Table 1-1. Lunar Resources Utilization Study Tasks.

<u>Basic Activities</u>	<u>Supplementary Tasks</u>
5.1 Comparison methodology & criteria	
5.2 Material requirements range & scenario development	
5.3 Lunar utilization systems concept,..... definition	Material characterization during processing; process working fluid requirements
5.4 Preliminary LRU cost effectiveness determination	Expanded economic analysis
5.5 Preliminary decision analysis	
5.6 Sensitivity & uncertainty analyses.....	Evaluate earth vs space mfg costs
5.7 Recommendations.....	Define early technology experiments

The initial study effort, Task 5.1, developed criteria and figures of merit for use in comparing LRU system concepts with the earth resources baseline. This information was required early in the study to provide a guide for the concept definition activity of Task 5.3. Initial space program scenarios and material requirements were also developed early (Task 5.2) to provide a basis for LRU concept sizing in Task 5.3. The activities of Task 5.3 identified and defined alternative LRU system concepts, assessed technical feasibility and determined system costs. In Task 5.4 the material requirements threshold at which LRU concepts become economically feasible was defined. Tasks 5.2 and 5.3 were iterated following the Midterm for the most promising LRU program scenarios. A sensitivity and uncertainty analysis was then performed in Task 5.6,

which identified the key parameters with respect to LRU technical and economic feasibility. Task 5.5 related the space program scenarios and lunar resource utilization programs to define the achievements necessary to justify LRU implementation. The last task (5.7) used study results as a basis for preparing recommendations and plans for future LRU activities.

Two supplementary activities were added to expand the study scope. The first provided for the services of five nationally recognized authorities on space manufacturing as study technical reviewers. The second authorized special emphasis work which expanded work on four study tasks. Under Task 5.3 we conducted a material processing analysis to determine unrecoverable losses and predict excess material requirements. Also included was an evaluation of manufacturing steps to determine fluid requirements, with special attention on water for cooling, washing, etc. An expanded present value economic analysis was conducted within Task 5.4, and a supplement to Task 5.6 evaluated economic comparison results to determine why in-space production costs were lower than earth-based costs. Under Task 5.7 we identified LRU-related technologies suitable for experimental verification with Shuttle-based orbital testing.

SI (metric) units have been used for principal calculations and all reporting of LRU study results unless specifically noted otherwise. Metric tons (1,000 kg) are indicated with the symbol T. Prefixes k, M and G denote values of 10^3 , 10^6 , and 10^9 , respectively. Thus, MT refers to millions of metric tons.



2

COMPARISON METHODOLOGY AND CRITERIA (TASK 5.1)

TASK - Develop study guidelines and the methodology and criteria to be used for comparing the relative merits of using earth versus lunar materials for space construction. Specific figures of merit usable over a wide range of input variables are necessary to support the broad parametric nature of the study. Obtain NASA approval of these guidelines, figures of merit, and the comparison methodology.

APPROACH - A primary study objective is to compare alternative space manufacturing concepts which utilize lunar material, with a conventional baseline concept using earth resources. The objective of this early study task is to develop the figures of merit and associated methodology that will be used later in the study to accomplish the comparison.

The development of this data can be segregated into four distinct categories:

- 1) Prepare study guidelines
- 2) Define evaluation criteria for comparing
 - Lunar resource utilization concepts
 - The Earth Baseline construction concept
- 3) Identify meaningful figures of merit applicable for
 - A range of material requirements scenarios
 - Competitive lunar resource utilization concepts
- 4) Develop a comparison methodology for LRU concept evaluation
 - Logical approach for applying figures of merit
 - Plan for accomplishing study objectives

Each of these categories are addressed in the following four subsections.

2.1 STUDY GUIDELINES

Guidelines for conducting this study were obtained from the NASA JSC Request for

Proposal, from Convair's response to this RFP, from discussions with cognizant NASA personnel, and from activities conducted during performance of the first two study tasks. This list of guidelines was developed during the study to document assumptions and provide boundary conditions for the scope of our investigation. These boundary conditions are important since they provide guidance during this initial comparative assessment of lunar resource utilization. This constrains the scope of the study and allows useful tentative conclusions to be reached within the allocated funding. The guidelines also serve as important indicies of what can be done during subsequent studies to expand the scope of the study and evaluate secondary alternatives.

- 1) The Earth Baseline large space structure construction program, with which lunar resources utilization concepts will be compared, shall be the satellite power system (SPS) preliminary baseline concept described by NASA JSC's January 25, 1978 systems definition study document.
- 2) The high construction scenario for lunar resources utilization developed during study task 5.2, shall also include the satellite power system baseline concept of guideline 1. The material used to construct these satellites will be revised from Earth Baseline requirements during task 5.2 to account for substitution of lunar resources.
- 3) Lunar resource utilization guidelines shall be compatible with those for NASA's earth resources baseline. These guidelines include the following:
 - a) SPS operational date is year 2000
 - b) All ground rectennas sized for 5 GW
 - c) SPS operations occur in geosynchronous orbit
 - d) Microwave power transmission system operating frequency is 2.45 GHz
 - e) Microwave power density is not to exceed 23 and 1 mW/cm² at center and edge, respectively, of rectenna (rectenna's for Earth Baseline and SPS constructed with lunar resources will be identical)
 - f) System life is 30 years with no salvage value or disposition costs

- g) Zero launch rate failure assumed
 - h) Technology availability date is 1990
 - i) No cost margins will be used
 - j) Cost estimates in 1977 dollars
 - k) System weight growth factor to be reflected in costs
 - l) RDT&E (including first production unit), production unit, and maintenance and operations cost estimates should be identified separately
 - m) KSC launch site w/flyback booster
 - n) All earth propellants derived from coal, air, and water
 - o) 500 mission life of launch vehicles
 - p) 50 mission life of space-based vehicles
- 4) The study shall develop and compare alternative lunar resource utilization concepts. These alternatives shall include variations in material processing and fabrication locations. (RFP guideline.)
- 5) Lunar resource utilization shall be evaluated for a range of material requirements. Specific mission scenarios shall be developed to define these material requirements. (RFP guideline.)
- 6) Anorthite shall be the basic lunar resource used for producing silica glass, silicon solar cells, aluminum, other structural materials and oxygen propellant. (RFP guideline.) This does not preclude the use of other lunar soils.
- 7) Production SPS materials will be derived from lunar resources as allowed by lunar availability, processing/manufacturing difficulty, and quantity requirements. Lunar resources will be used for manufacturing all suitable large space structure components. Suitable components are those that can be easily redesigned for use of lunar derived materials, and are required in sufficient quantity to justify an automated space manufacturing facility. The only materials or products imported from earth are those which are either unavailable in lunar resources, or which because of complicated manufacturing operations requiring expensive facilities coupled with relatively small quantity requirements can be

more economically obtained from earth .

- 8) All lunar resource utilization space facilities will be delivered from earth (no bootstrapping). This guideline simplifies the analysis of alternative lunar resource utilization concepts since steady state operations can be compared. Alternative construction options for in-space manufacturing of large structures such as Satellite Power Systems include:

Steady State	A constant SPS production rate following a brief start-up period to shakedown earth delivered manufacturing facilities.
Bootstrapping	A progressively increasing SPS production rate obtained by starting with modest "seed facilities" which are continuously expanded using nonterrestrial materials.
Hybrid	A combination of bootstrapping facility development to reach full production capability, followed by steady state product manufacturing.

Each of these manufacturing options offers potential program benefits as noted in Table 2-1. The selection of steady state operations for this study was not based on the relative merits of the options listed. Its selection was based on compatibility with the earth baseline so that comparative analyses could be readily performed without extensive manipulation of earth baseline data. The use of this guideline simplifies the analysis of alternative lunar resource utilization concepts since steady state operations can be readily compared with earth baseline SPS construction. If bootstrapping is employed, no significant period of steady state operation exists since the in-space production capability is continually being increased. The bootstrapping technique offers the advantage of reducing the quantity of facilities which must be initially transported from earth. Its disadvantage is that in-space labor intensive activities are required for fabrication and start-up of expanded processing capability, and a longer start-up period is required to meet the desired "steady-state" production rate. This guideline does not preclude utilization of lunar materials for facility requirements when it is obviously desirable to do so. These applications include process chemicals

derived from lunar resources, plus lunar base foundations and radiation shielding constructed with lunar materials for manned facilities.

- 9) A prototype or demonstration SPS built from earth materials, and the transportation elements required for its placement, will be needed regardless of resource origin for production satellites. A common space transportation system "starting point" should be used for evaluating both Earth-based and lunar material based construction of large space structures. Prior to initiating either of these full-scale production programs, an earth-based prototype satellite will be required to demonstrate program feasibility. This satellite will probably be sufficiently large to require development of an SDV and OTV for its in-space construction and orbital placement. Configuration and performance capability of these two vehicles should be mutually agreed to by JSC and General Dynamics Convair. These two "existing" vehicles will then serve as common transportation system elements available for use by any full-scale material utilization option.

Table 2-1. LRU Manufacturing Options.

STEADY-STATE

- All facilities constructed and checked out on Earth
- Fabrication and start-up costs readily identified

BOOT STRAPPING

- Lower initial facility investment and delivery costs
- Practical space processing experience can be incorporated when expanding production capability

HYBRID

- Lower initial facility costs

STEADY-STATE OPTION SELECTED FOR INITIAL STUDY COMPARISON

- Compatibility with Earth baseline
- Material threshold point easily scaled to construction rate

- 10) Non-conformity with current NASA budget limitations will not reject an otherwise promising concept. Some previous space manufacturing studies have used the current NASA budget as a funding constraint for LRU development and start-up operations. Lunar resource utilization is a complex endeavor by anyone's standards. Its scheduling is complicated by the fact that it includes all the earth baseline construction elements, with the possible exception of HLLV, in addition to judicious phased development and installation of space manufacturing related facilities. It is important that space manufacturing capability be developed as rapidly as possible because the return on investment will not even start until the facilities are operating. On the other hand, it is not practical to assume that authorization to proceed with all aspects of lunar resource utilization would occur simultaneously. Economic benefits are enhanced with an accelerated development schedule but the realities of budget constraints must be dealt with. A careful balance between these forces tending to accelerate and delay development must be maintained to arrive at a reasonable and credible development plan.
- 11) Fixed production rates for a 30 year period will be used. Any build-up sequence required to reach these production rates is assumed to be sufficiently brief so that it has no appreciable influence on the average steady state operations. This guideline is only valid when used in conjunction with guideline 8. When lunar resource processing facilities start production, they will probably operate at a rate considerably below their designed capacity. The period required to reach full production should be relatively brief, however, since all the equipment necessary for achieving this rate is included in the initial facility. All initial equipment checkout, pilot runs, and other preproduction space activities shall be considered part of the development or start-up phase. Thus, full steady state production should be achieved in a year or two, which has a negligible effect on the average production rate over the entire 30 year operating span.

12) Lunar mining equipment, material handling and logistics facilities, and in-space material processing and fabrication facilities shall all be automated to at least the level of modern comparable facilities currently in use, or being planned for use, on earth. Estimates on facility mass, power requirements, and personnel requirement will be based on this state-of-the-art level of automation.

2.2 EVALUATION CRITERIA

Two types of criteria are normally employed for concept evaluation - quantitative and qualitative. Quantitative criteria include items such as cost, energy consumption and schedules, while qualitative criteria encompass items such as technical feasibility and programmatic considerations. As a first step in developing criteria, we reviewed existing data on space manufacturing approaches and space construction programs such as SPS to determine what were considered key issues and parameters. This collection of criteria, shown in Table 2-2 were used as potential candidates for this study.

The criteria listed in Table 2-2 have been separated into two categories; quantitative, which are generally cost related, and qualitative which are less cost related and more judgemental. Many of these judgemental criteria can also be assessed in quantitative terms as well as qualitatively. This quantitative assessment often is accomplished via economic indices, i.e., cost.

For purposes of the Lunar Resources Utilization for Space Construction study, the following candidates have been selected as evaluation criteria:

- Cost shall be the basic criterion for assessing lunar resources utilization.
- The earth material requirement criterion shall be used for initial comparison and concept screening.
- Secondary judgemental criteria shall include technical feasibility, programmatic considerations, and environmental impacts.

The other candidates in Table 2-2 are also valid criteria, but are less applicable for an initial feasibility assessment than those selected.

The next step is to convert these criteria into specific figures of merit suitable for LRU concept assessment and comparison with the Earth Baseline construction technique.

Table 2-2. Candidate Evaluation Criteria.

Quantitative	Qualitative
Total Program Cost	Technical Feasibility
Development	Programmatic Considerations
Fabrication	Economic Risk
Transportation	Schedule Risk
Operations	
Support	Environmental Impacts
Transportation Energy Comparison	Technical Spinoffs
Earth Energy Consumption	Humanistic Spinoffs
Profitability	Public Support/Confidence
Development/Start-up Schedule	International Involvement
Earth Material Requirement	

2.3 FIGURES OF MERIT

One or more specific figures of merit can be developed from each of these evaluation criteria. Initial analyses, conducted during proposal preparation, showed that the earth material requirement was an excellent figure of merit for preliminary concept comparison. The earth material requirement was defined as the kilograms of material that must be launched from earth (including propellants) for each kilogram of large space structure construction material. This figure of merit was applied for steady-state comparisons. The earth material requirement (EMR) is an

extremely useful figure of merit since it reflects the overall steady state operational efficiency of lunar resource utilization options, as compared to the Earth Baseline. The objective of LRU options is to construct large satellites primarily with lunar materials. This should significantly reduce the amount of earth components and supplies required, which also reduces the traffic over the very expensive earth to GEO route. This reduction in earth material requirements then, is a key ingredient in assessing the overall viability of any lunar resource utilization concept. The lower its EMR, as compared with the earth construction baseline, the better that concepts chances are of being a feasible LRU concept.

Cost is a basic figure of merit. Total program cost is always a criterion; however, specific elements of cost can also be significant for comparisons. Development cost is often a key criterion in program decisions, since it involves early funding. Startup costs are similar to development costs, since expenditures for implanting LRU transportation elements and facilities may occur over an extended period without any payback. Therefore, the combination of development and start-up costs have been used as an important figure of merit in determining the investment required for alternative lunar resource utilization concepts.

Steady state production costs are useful for determining the relative efficiency of candidate concepts. Approximate production cost magnitudes for the Earth Baseline SPS program are shown in Figure 2-1. From Figure 2-1 it is apparent that nearly one-fifth the total cost is associated with the earth-based ground reception system and these costs are of no concern to the assessment of earth versus lunar materials for space construction. With the ground reception system cost removed, the remaining costs are divided between satellite manufacturing and transportation.

Satellite manufacturing costs are important criteria because they provide a standard from which to derive incremental costs (higher or lower) associated with manufacturing

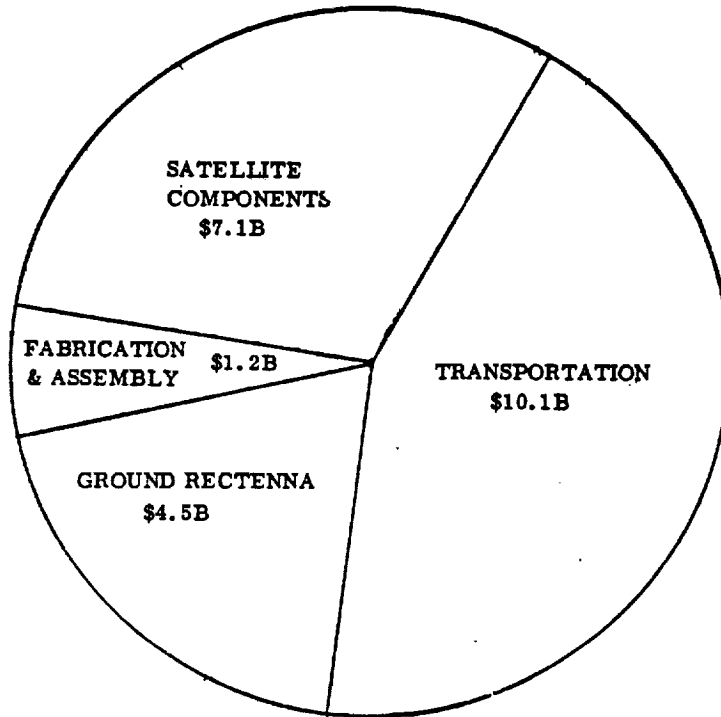

AVERAGE COST PER SPS \$22.9B

Figure 2-1. Average unit SPS costs.

in space or on the moon. The transportation cost, which is slightly greater than the SPS material and manufacturing cost, is extremely important because of its magnitude and sensitivity to alternate scenarios utilizing lunar materials. Transportation, especially from earth to LEO, is considered a principal cost driver.

Total transportation cost includes contributions for transfer of cargo and personnel between each activity location. These transportation cost contributors are listed in Table 2-3 for the Earth Baseline and lunar resource utilization scenarios.

The total manufacturing cost is comprised of purchased parts and in-space processed and fabricated items. These manufacturing cost contributors are identified in Table 2-4 for both the Earth Baseline and LRU concepts.

Table 2-3. Transportation cost contributors.

Transportation Cost Contributors	
Baseline Scenario - Earth Materials	
Cargo	Earth to LEO
Cargo	LEO to GEO
Personnel	Earth to LEO & Return
Personnel	LEO to GEO & Return
Space & Lunar Based Scenarios	
All Baseline Scenario Cost Factors, plus	
Lunar Material	Moon to L ₂ } Moon to SMF
Lunar Material	L ₂ to SMF }
Cargo	LEO to LLO
Cargo	LEO to SMF
Cargo	LLO to Moon
Cargo	LLO to SMF & Return
Cargo	SMF to L ₂
Cargo	SMF to GEO
Personnel	LEO to LLO & Return
Personnel	LEO to SMF & Return
Personnel	LLO to Moon & Return
Personnel	LLO to SMF & Return
Personnel	SMF to L ₂ & Return
Personnel	SMF to GEO & Return

Table 2-4. Manufacturing cost contributors.

Manufacturing Cost Contributors
Baseline Scenario - Earth Materials
Earth Purchase Price
LEO Logistics
LEO Fabrication & Assembly
GEO Final Assembly
Space & Lunar Based Scenarios
All Baseline Scenario Cost Factors, plus
LLO Logistics
Lunar Mining
Lunar Beneficiation
Lunar Logistics
Space (or Lunar) Processing
Stock Forming
Component Manufacturing
SMF Logistics
SMF Fabrication & Assembly

The combination of these individual figures of merit; development cost, start-up cost, steady state transportation costs, and steady state manufacturing costs and the cost for operating completed satellites yields the total program cost of each concept for the operational period selected.

The selected judgemental evaluation criteria can also be used as specific figures of merit. Table 2-5 shows these criteria.

Although these judgemental figures of merit can be expressed quantitatively, they will be used qualitatively during the initial assessment of LRU concepts. During performance of Task 5.6, sensitivity and uncertainty analyses, however, the first two judgemental risk

Table 2-5. Judgemental considerations.

<u>Evaluation Criteria</u>	<u>Figures of Merit</u>
Technical Feasibility	Technical Risk
Programmatic Considerations	Economic Risk Schedule Risk
Environmental Impacts	Material Scarcity Air Pollution Noise Pollution

areas will be assessed quantitatively as cost and technical uncertainties. These are reflected as cost differences to nominal cost estimates.

To summarize, total program cost shall be the basic criterion for assessing lunar resources utilization. Other secondary assessment criteria include earth material requirements and environmental considerations.

2.4 COMPARISON METHODOLOGY

The figures of merit described in the preceding discussion could be applied simultaneously to each lunar resource utilization concept. This would allow total program cost comparisons of all LRU candidates with the Earth Baseline. The development of all these cost elements for each LRU candidate would be very time consuming. In addition, a large percentage of this effort would be expended on assessing non-competitive LRU concepts. There must exist a procedure by which certain figures of merit can be initially used to assess and modify/combine a wide range of LRU options. This incremental assessment technique would mold these many options into several highly competitive representative concepts which would then be subjected to the complete total program costing analysis and subsequent Earth Baseline comparison.

This is a very desirable approach, but its implementation is dependent on the answer to these questions:

- 1) How can we justify in incremental assessment approach?
- 2) Which cost criteria have the greatest influence; steady state production or development and startup?
- 3) In what order should the individual figures of merit be applied to provide a valid incremental assessment?

To resolve these questions, a previous economic analysis of lunar resource utilization was used in an attempt to understand the influence of individual cost elements (or figures of merit) on the system's total program cost. This previous analysis performed by Mark Hopkins during the 1975 NASA Ames Summer Study on Space Settlements, is documented in references 1 and 2. This data has been modified to obtain some compatibility with the JSC Earth Baseline in areas with similar requirements. Also, costs clearly related to large habitats have been deleted, learning effects have been omitted, and costs have been adjusted from 1975 to 1977 dollars. An explanation of these adjustments is contained in Section 3.3. It must be emphasized that cost data from this 1975 analysis was generated with groundrules and assumptions totally incompatible with those subsequently used for the NASA-JSC Earth Baseline SPS Economic Analysis. Modification of this 1975 data has been limited to only the most obvious discrepancies. The only purpose for using this information is to gain an early understanding of the relative importance of steady state production costs as compared to development costs.

The results of the Modified 1975 Summer Study Economic Analysis are shown in Figure 2-2. The lower crosshatched region contains development and startup costs, the center band contains costs for the earth based ground power reception system, and the upper crosshatched region contains production costs. Costs for 30-years have been shown as a function of the number of satellites in the system.

Research and development costs are adjusted to \$139.7 billion, as described in Section 3.3. The support system costs include development of mass launchers, mass

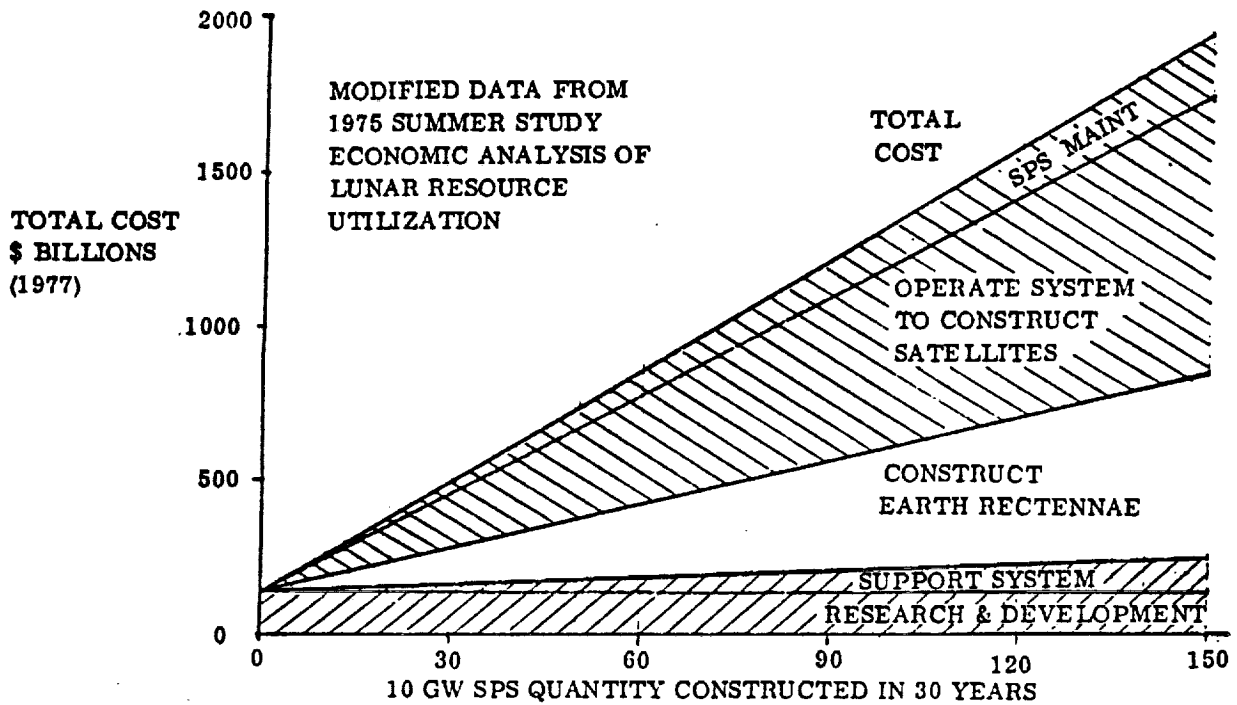

Figure 2-2. Lunar resource utilization cost projections from previous work.

catchers, transportation system elements, space fabrication facilities, and the lunar base needed to support the operational program. The construction of earth rectennae is a large share of total cost, but one that is independent of earth or lunar resources selection for construction of the satellite. In a program of 30 or more satellites, the largest single cost element is operating the system to construct satellites. This cost includes materials from the earth, processing of lunar materials into satellite components, fabrication labor, the crews that operate the support system, and transportation including crew rotation and resupply, but excludes the effects of learning. SPS maintenance includes only the materials, labor, and transportation related to maintaining operational satellites to ensure their continued production of electric power.

From Figure 2-2, it may be concluded that, in a large scale system, operating the system to produce satellites is the major contributor to cost. In fact, if construction costs for the earth rectennae are ignored, combined in-space operations costs (including maintenance), exceed those for research and development and support

system acquisition, at the 25 satellite construction level.

The answers to our three questions, therefore, are:

- 1) Previous LRU economic analysis results can be used to indicate the relative importance of cost elements, and justify an incremental assessment approach.
- 2) For a construction rate of one 10 GW satellite power system per year or more, in-space construction, maintenance, and operating costs have the greatest economic influence on total program costs.
- 3) Based on this, steady state figures of merit are a useful discriminator for early comparative evaluation of LRU system concepts. Specifically, steady state earth material requirements will be used for the initial screening and comparative evaluation of alternative LRU concepts.

2.4.1 COMPARISON APPROACH. The desired end result of comparing satellite construction with earth supplied versus lunar derived materials is to define the program size (quantity of satellites) at which a cost crossover occurs. This can only be determined by developing costs for a lunar resource utilization program. Unfortunately, many alternative concepts exist for constructing satellites with lunar materials, and it is not obvious which of these might result in the lowest program cost.

To resolve this difficulty, an approach has been developed which performs comparative assessment and preliminary screening of alternate LRU concepts while obtaining the information required for costing. This approach analyzes LRU concept performance during steady state operations to develop vehicle and facility sizing requirements. The comparative index used for assessing alternative concepts is earth material requirements (EMR).

The overall approach to LRU assessment is depicted in Figure 2-3. Initially, candidate lunar resource utilization concepts employing alternative transportation techniques and

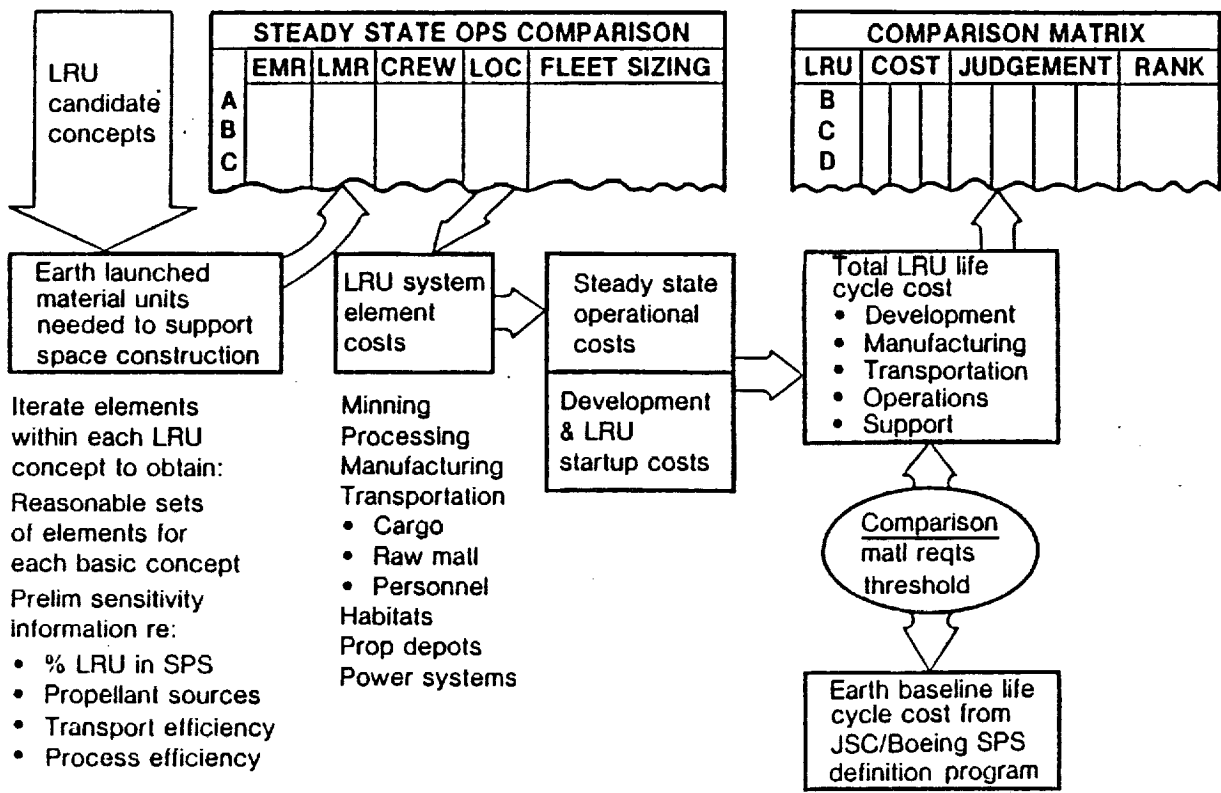

Figure 2-3. Comparison approach.

processing locations are postulated. These concepts are evaluated to determine the earth material requirements (EMR) for supporting satellite production. This LRU concept assessment technique employs the steady state material logistics scenario comparison approach to iterate LRU candidates and obtain a reasonably low EMR. The iteration procedure selects and combines LRU system elements into several highly competitive concepts. The resulting "optimized" steady state material logistics scenarios are then used to size each LRU system element.

System element costs are then developed based on this steady state sizing information. Some elements are similar or identical for more than one LRU system concept, therefore, so are their costs. Element costs include development, production, and

operating costs. The steady state sizing information can also be used to define start-up requirements and associated costs.

System element costs for each LRU concept are then combined with start-up costs to obtain the total program cost, which is compared with the earth baseline life cycle costs to determine the material requirements threshold (or cost crossover) point. This material requirements threshold point is determined for each competitive LRU system concept.

Further comparison at the overall system and system element level can then be accomplished to provide additional insight into specific parameters associated with each LRU concept. These comparisons include both economic and judgemental criteria. Economic indices encompass transportation and manufacturing costs of each LRU systems concept. Judgemental factors embody consideration of start-up difficulties, schedule risks, and environmental effects.

The detailed procedure used to accomplish this assessment of lunar resources utilization is further defined in the following paragraphs, along with reference task and report section numbers where this information is contained.

- ESTABLISH SATELLITE PRODUCTION REQUIREMENTS — Development of a representative manufacturing scenario and its associated material requirements was accomplished to permit LRU assessment. (Task 5.2, Section 3)
- DEFINE CANDIDATE CONCEPTS — Alternative lunar resources utilization concepts were differentiated by in-space activity locations and the transport techniques employed for transfer of raw materials, cargo, and personnel. Generalized LRU systems concepts representative of space based, lunar based, and combination space/lunar based operating scenarios were initially postulated. (Task 5.3, Section 4)

- DEVELOP STEADY STATE MATERIAL LOGISTICS SCENARIOS — Steady state material logistics scenarios were developed for each of these alternative concepts to determine the quantity of earth and lunar materials required to support a space construction program. An example material logistics scenario is shown in Figure 2-4. LRU element sensitivity was developed by assessing the effect of various options on earth material requirements. The earth material requirement (EMR) is defined as the kilograms of material that must be launched from earth (including propellants) for each kilogram of completed large space structure in geosynchronous orbit. This figure of merit was applied for steady-state comparisons. EMR is an extremely useful figure of merit since it reflects the overall steady state operational efficiency of lunar resource utilization options, as compared to the earth baseline, and permits elimination of non-competitive concepts prior to costing. (Task 5.3, Section 4)
- ITERATE TO OBTAIN IMPROVED CONCEPTS WITH LOW EARTH MATERIAL REQUIREMENTS — Three representative LRU concepts were obtained by an

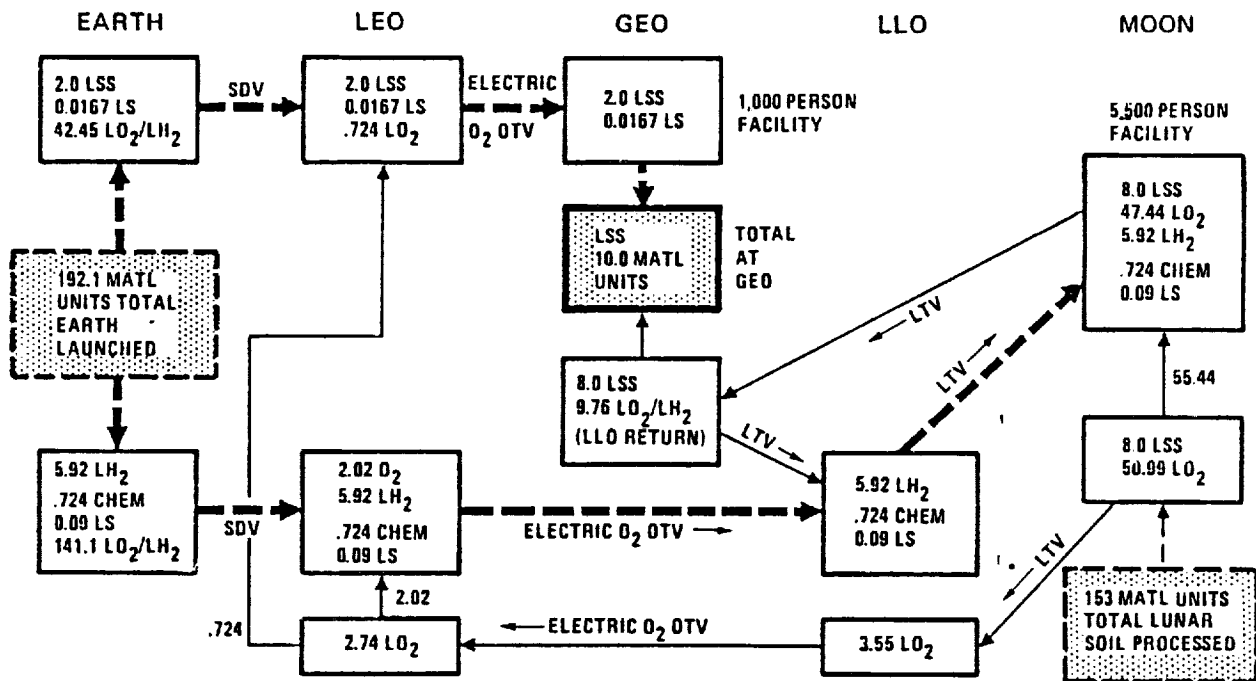

Figure 2-4. Example steady-state cargo transfer scenario for a LRU concept with conventional chemical Lunar Transfer Vehicle.

iterative process described in Figure 2-5, which used minimum EMR as the selection criteria. These three LRU implementation techniques are identified in Table 2-6 as Concepts B, C and D, along with the reference earth baseline, Concept A. They are characterized by the material processing location and the launch vehicle employed for transporting material from the moon. Concept development resulted in the use of similar transportation elements for transfer of cargo and personnel between activity locations other than lunar surface to low lunar orbit. (Task 5.3, Section 4)

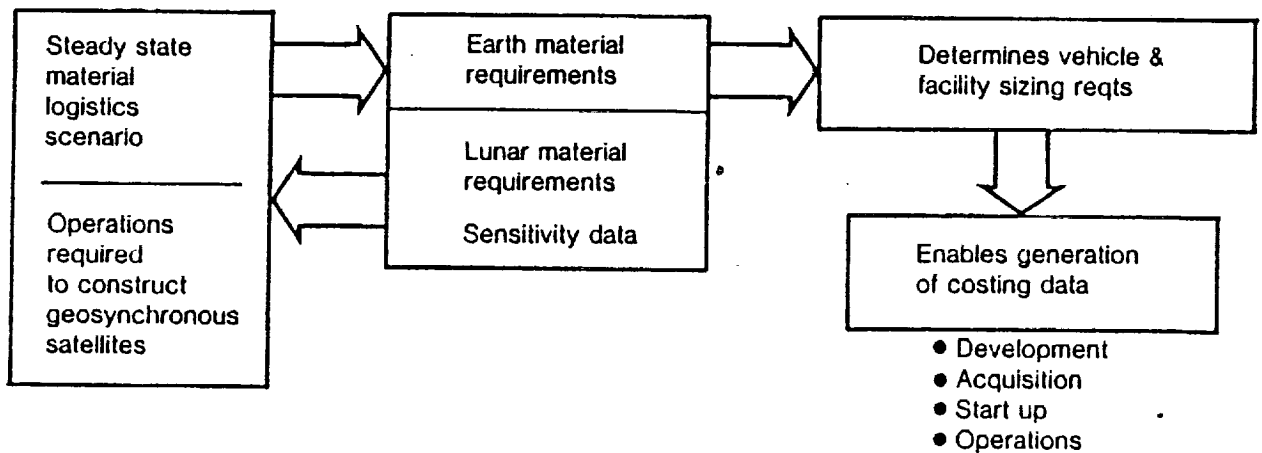

Figure 2-5. Iterative approach for developing representative LRU concepts.

Table 2-6. Alternative construction concepts.

Designation	Earth launch vehicle	Material processing location	Lunar material launch vehicle		
			Description	Propellant	Propellant source
Reference earth baseline	A HLLV	Earth	—	—	—
LRU concept	B SDV	In-space	Mass driver catapult & mass catcher	Electricity Oxygen	Solar or nuclear Moon
LRU concept	C SDV	Lunar surface	Chemical rocket	Oxygen & hydrogen	Moon Earth
LRU concept	D SDV	Lunar surface	Chemical rocket	Oxygen & aluminum	Moon Moon

- DETERMINE VEHICLE & FACILITY SIZING REQUIREMENTS — Logistics scenarios, which define earth and lunar material needs including vehicle propellants at each activity location, were employed in conjunction with the required satellite production rate to determine vehicle and facility sizing requirements data. (Task 5.3, Section 4)

- GENERATE ELEMENT COST DATA — System element costs were then developed based on this steady state sizing information. Some elements were similar or identical for more than one LRU system concept, therefore, so were their costs. Element costs included development, production, and operating costs. (Task 5.3, Section 5)

- DEVELOP START-UP INFORMATION & COST — The steady state sizing information was also used to define start-up requirements and associated costs. (Task 5.3, Section 5)

- OBTAIN TOTAL LRU CONCEPT PROGRAM COSTS — System element costs for each LRU concept were then combined with start-up costs to develop total program costs for each nominal LRU concept over a fixed 30 year operational period. (Task 5.3, Section 5)

- COMPARE WITH EARTH BASELINE PROGRAM COST TO DETERMINE MATERIAL REQUIREMENTS THRESHOLD — LRU program costs were then compared with earth baseline costs developed using compatible groundrules, to define a preliminary material requirements economic threshold as depicted in Figure 2-6. This threshold determined the material utilization level in geosynchronous orbit at which LRU became competitive with earth resource utilization. (Task 5.4, Section 5)

- **GENERATE COST SENSITIVITY AND UNCERTAINTY DATA** — This initial nominal threshold was then revised to account for the effects of cost and technical uncertainties, as shown in Figure 2-7. (Task 5.6, Section 5)
- **PERFORM PRESENT VALUE ECONOMIC COMPARISON OF LRU CONCEPTS & THE EARTH BASELINE** — Total nominal program costs were revised to account for cost discounting (a present value economic analysis) and compared. (Task 5.4, Section 5)

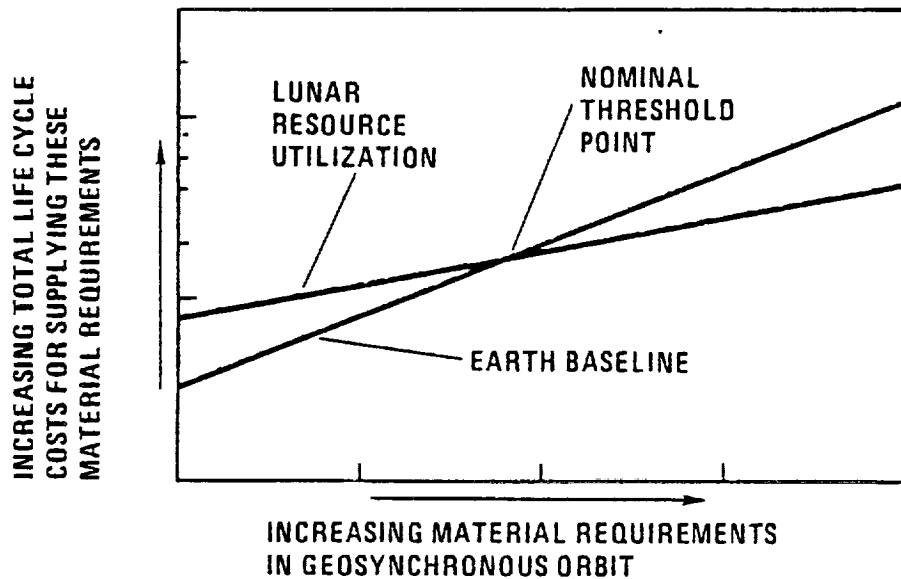

Figure 2-6. Initial nominal economic comparison of LRU and Earth Baseline concepts.

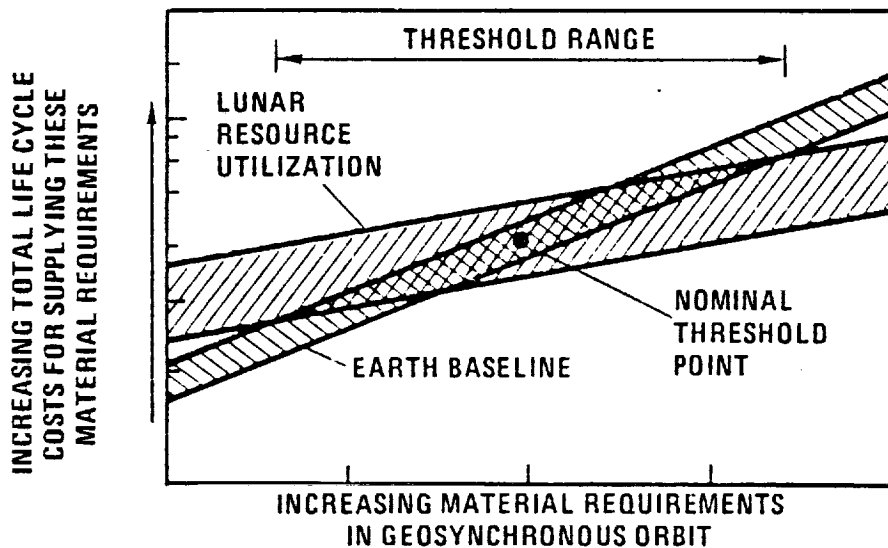

Figure 2-7. Comparison of LRU and Earth Baseline concepts including cost uncertainties.

REFERENCES

1. Johnson, R. D., et al, "Space Settlements a Design Study," NASA SP-413, NASA Scientific Technical Information Office, Washington, D. C., 1977.
2. Hopkins, M. M., "A Preliminary Cost Benefit Analysis of Space Colonization," Journal of the British Interplanetary Society, Vol. 30, No. 8, August 1977.

3

MATERIAL REQUIREMENTS AND SCENARIO DEVELOPMENT (TASK 5.2)

TASK - Establish requirements for usable construction materials in earth orbit via three or more space program scenarios. These scenarios are to be time phased sequences of space construction activity, and will be generated using NASA JSC consultation and guidance.

APPROACH - Identification of mission scenarios and associated satellite material requirements is separated into three phases as shown in Figure 3-1. Initially, separate scenarios will be developed to represent a low, two intermediate, and a high material usage model which we expect will "bracket" the cost effectiveness point of lunar resource utilization. A time period of 30 years of operation will be

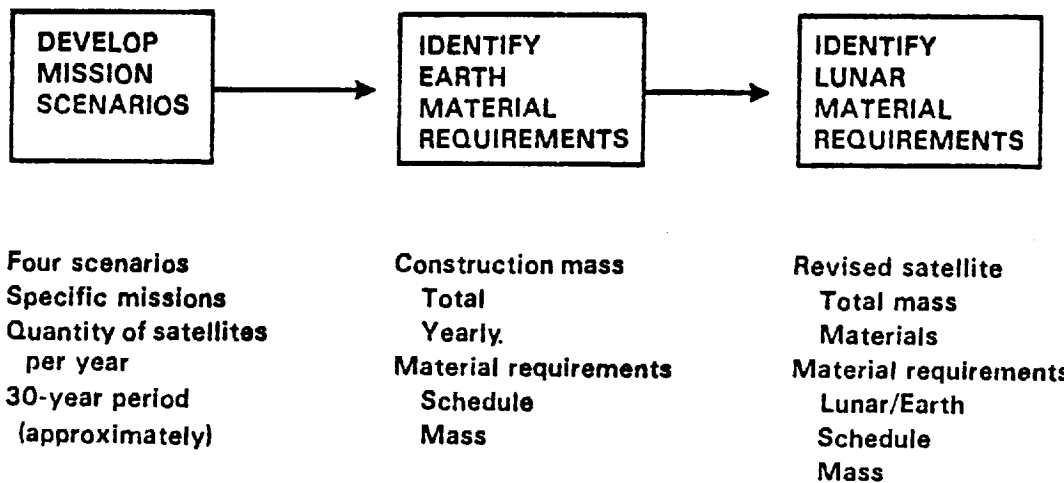

Figure 3-1. Lunar material requirements development.

considered. The second step is to identify the time-phased accumulated earth material requirements for satellite construction. Finally, the corresponding lunar material substitutes and remaining earth materials from which these satellites could be constructed will be determined. Previous studies have indicated that a very large quantity of satellite construction material is needed to justify development, delivery, and start-up of lunar mining, processing, and manufacturing

facilities. Satellites other than satellite power systems (SPS) will be evaluated to determine if their total material requirements approach the quantity needed to justify use of lunar resources. If not, their material requirements when combined with SPS will be investigated to determine the sensitivity of the total requirements (percentage of each material) with and without these other-than-SPS required materials.

3.1 GROUND RULES AND ASSUMPTIONS

There are several realistic assumptions which can be made concerning candidate satellites for lunar resource utilization:

- 1) They should either be multiple identical satellite systems or consist of a family of similar satellites. This is valid since construction of unique satellites cannot be used to justify an in-space mass production facility. This is true for satellite construction using either earth or lunar-derived materials.
- 2) The satellites should be located in a high earth orbit such as geosynchronous. This is important since the entire lunar resource utilization concept's economic effectiveness is based on reduced transportation costs. The ΔV required to bring lunar material to LEO is approximately 73% of that for orbiting material from earth's surface. This is not a sufficient velocity margin for realizing any substantial economic benefit. For comparison, the ΔV for lunar material utilization at GEO is 37% of that for earth material.
- 3) Lunar resources will be used for manufacturing all suitable large space structure components. Suitable components are those that can be easily redesigned for use of lunar derived materials, and are required in sufficient quantity to justify an automated space manufacturing facility.
The only materials or products imported from earth are those which are either unavailable in lunar resources, or which because of complicated manufacturing operations requiring expensive facilities coupled with relatively small quantity requirements can be more economically obtained from earth.

3.2 DEVELOPMENT OF LOW SCENARIO TOTAL MATERIAL REQUIREMENTS

The low scenario shall consist of proposed satellites which satisfy groundrules 1) and 2), with the exception of Satellite Power Systems, which are purposely omitted from this scenario. Definition of all candidate satellites was obtained from the Aerospace Corporation report entitled "Advanced Space System Concepts and their Orbital Support Needs (1980 - 2000)", Reference 1. The forty-two civilian initiatives identified in this report to provide future observation, communications, and support services were evaluated per groundrules 1) and 2) to obtain the 25 candidate service satellites listed in Table 3-1. Some of these candidates have been organized into groups appropriate for an early (1985) geosynchronous public service platform, and a subsequent (1990) expanded public service platform. Combining these various service functions into two large multifunctional platforms will probably result in some function integration, with a corresponding reduction in total satellite mass requirements. This potential benefit has not been included in Table 3-1 data for PSP 1 and PSP 2. Six other service satellites are identified in Table 3-1 which satisfy our two groundrules, but should not be integrated into either public service platform due to their positioning requirements or mass.

Total material requirements have been determined by the quantity of these satellites which will be needed during a thirty year period. This quantity has been estimated based on the current gross national product (GNP), geographical conditions, and number of large cities for individual countries or groups of countries. Table 3-2 shows the approximate GNP ranking of these countries/regions. The regions were arbitrarily comprised of quasi-compatible countries in the same geographical area.

The estimated quantity of coastal anti-collision radar satellites (CO-9) is based on coastline length, GNP ranking, and the importance of shipping to that country or region. Two CO-9 satellites are required for each 4000 km of monitored coastline. A total quantity of 30 has been selected out of the 66 needed for complete coverage.

Table 3-1. Candidate satellites for the low material requirements scenario.

Geosynchronous (1985)	No *	Mass (T)	Power (kW)	Antenna (m ²)	Constellation Size
Fire Detection	CO-2	11.36	2.0	100	1
Water Level & Fault Movement Indicator	CO-3	0.36	0.25	-	1
Synchronous Meteorological Sat.	CO-12	1.36	1.0	20	3 (Global)
Interplanetary TV Link	CO-14	0.45	0.25	210	1
Diplomatic/U.N. Hotlines	CC-10	1.35	1.0	10	3 (Global)
Early Public Service Platform	PSP-1	14.9	4.5	340	Each Nation or Region
Geosynchronous (1990)	No *	Mass (T)	Power (kW)	Antenna (m ²)	Constellation Size
Border Surveillance	CO-8	3.64	20.0	8,800	1 (Per Border)
Urban/Police Wrist Radio	CC-2	8.18	75.0	3,400	1
Disaster Communications Set	CC-3	8.18	75.0	3,400	1
Electronic Mail Transmission	CC-4	9.09	15.0	3,400	1
Advanced T.V. Broadcast	CC-6	6.36	150.0	300	1
Voting/Polling Wrist Set	CC-7	5.91	90.0	1,900	1
National Information Services	CC-8	9.09	15.0	3,400	4 (National)
Personal Communications Wrist Radio	CC-9	7.27	21.0	3,400	1
3-D Holographic Teleconferencing	CC-11	6.82	220.0	300	1
Vehicle/Package Locator	CC-12	9.09	23.0	15,000	2 (National)
Personal Navigation Wrist Set	CS-7	1.36	2.0	13,100	1
Energy Monitor	CS-9	4.55	23.0	1,900	1
Vehicular Speed Limit Control	CS-10	10.00	430.0	16,500	1
Burglar Alarm/Intrusion Detection	CS-14	7.27	1.0	3,400	1
Expanded Public Service Platform	PSP-2	133.2	1,228	103,400	Each Nation or Region
Synchronous Elliptical (1985)	No *	Mass (T)	Power (kW)	Antenna (m ²)	Constellation Size
Small Individual Satellites					
Nuclear Fuel Locator	CO-7	1.36	0.3	150	4 (National)
Global Search & Rescue Locator	CC-1	0.68	1.0	10	20 (Global)
Rail Anti-Collision System	CS-13	1.36	0.5	150	3 (National)
Geosynchronous 1990 & On	No *	Mass (T)	Power (kW)	Antenna (m ²)	Constellation Size
Large Individual Satellites					
Coastal Anti-Collision Radar	CO-9	909.1	3,000	1.1×10 ⁶	2 (Each 4,000 km of coast)
Night Illuminator	CS-6	45.5	1.2	1.0×10 ⁶	1 (Lrg. City)
Power Relay Satellites	CS-15	272.7	-	0.78×10 ⁶	100 (Global)

* From Aerospace Corporation Report (1)

Table 3-2. Information employed for estimating satellite quantities

Approx. GNP * 1973 (\$B)	Country or Region	Number of Countries in Region	Increments of 4,000 km Coastline (Estimated)	Quantity of Satellites Required 1980 — 2010				Cities over 0.8×10^6 Population *
				CO-9	PSP-1	PSP-2	CS-6	
1,295	United States (USA)	(1)	3	6	2	2	44	50
1,127	Western Europe	(11)	2	4	2	2	20	25
- -	Russia (USSR)	(1)	1	2	2	2	20	25
413	Japan	(1)	1	2	1	1	10	10
- -	China	(1)	1	0	1		12	20
173	Scandinavia	(5)	2	2	1		5	5
160	South America	(11)	4	2	2	1	10	21
- -	Eastern Europe	(8)	1	0	1		6	8
119	Canada	(1)	2	2	1		3	3
115	Arabs (Plus Israel)	(15)	1	2	2	1	6	12
105	Southern Asia (India)	(6)	4	0	1		10	19
80	Africa (Central & South)	(29)	4	0	1		1	6
64	Australia/New Zealand	(2)	4	4	1	1	1	5
57	Central America	(7)	2	2	1		1	3
27	Taiwan/Phillippines/H. K.	(3)	1	2	1		1	4
TOTALS				30	20	10	150	

* 1977 World Almanac and Book of Facts - Published by Newspaper Enterprise Assoc. Inc. N. Y.

At least one early public service platform (PSP-1) has been estimated for each of the fifteen regions identified. Although one platform should meet total USA requirements, five regions (including USA) each have an additional platform to satisfy large information volume, land area, or nationalistic needs. This results in a total requirement of 20 PSP-1 satellites.

Similar rationale has been used for estimating the ten expanded public service platforms (PSP-2) required, except that PSP-2 was limited to the large most technically advanced regions and fastest growing industrial countries/regions.

The estimated quantity of night illuminator satellites (CS-6) was based on the number of cities with populations exceeding 800,000, the region's GNP ranking, and energy considerations. 150 CS-6 satellites, capable of illuminating 70% of all regions cities, have been selected.

These quantity estimates have been combined with the satellite mass projections of Table 3-1, to obtain a low material requirements scenario. This scenario, shown in Table 3-3, has an estimated total mass of 63,230 metric tons for all civilian satellites except SPS.

3.3 PRELIMINARY ESTIMATE OF NOMINAL MATERIAL THRESHOLD

In Table 3-3 we have developed a low material requirements scenario. The next step is to determine if this low scenario could be within the material requirements threshold range needed to justify lunar resources utilization. To evaluate this, cost data developed during the 1975 NASA Ames Summer Study on Space Settlements by Mark Hopkins (References 2 and 3) have been compared with NASA-JSC's Earth Baseline Concept (Reference 4).

Although many inconsistencies exist in the guidelines and methodology used for these two estimates, their comparison should yield a "preliminary nominal threshold point."

Table 3-3. Low material requirements scenario does not include satellite power stations

Satellite Description	Mass (T)	Quantity 20 Years	Quantity Estimate Rationale	Total Mass (T)
Early Public Service Platform (PSP-1) Fire detection, Meteorological, Water Level & Fault Movement, Diplomatic Hotlines, etc.	14.9	20	~1 each for major Indust. Nations plus regions contain- ing compatible Countries	298
Expanded Public Service Platform (PSP-2) Border Surveillance, Wrist Radio, Disaster Communications, Electronic Mail, Navigation, Vehicle/package Locator, etc.	133.2	10	Top 50 percent of industrial nations and regions using early public service platform (PSP-1)	1,332
Nuclear Fuel Locator (CO-7)	1.4	80	4 per PSP-1 Region	109
Rail Anti-Collision Sys. (CS-13)	1.4	60	3 per PSP-1 Region	109
Global Search & Rescue (CC-1)	0.7	20	Aerospace Report	14
Coastal Anti-Collision Radar (CO-9)	909.1	30	2 per Indust. Coast- line	27,273
Night Illuminator (CS-6)	45.5	150	70% of major cities	6,825
Power Relay Satellite (CS-15)	272.7	100	Aerospace Report	27,270
TOTAL MASS				63,230

To determine this preliminary threshold point, comparative development/startup costs and operations/production costs must be obtained.

Table 3-4 displays system element development/start-up costs for the JSC baseline, which were obtained directly from the JSC January 25, 1978 reference document, and corresponding estimates for similar elements based on 1975 Summer Study results. Since the 1975 Summer Study was simultaneously estimating the construction of both colonies and satellite power systems, it is difficult to accurately separate their corresponding costs. Summary data indicates a total development/start-up cost range from \$111.5 B to \$175.7 B for start-up and manufacture of the initial SPS. The minimum value was used in Table 3-4 to account for hidden colony costs and obtain a lower nominal threshold point.

Comparison of the figures displayed indicates several missing costs, plus low estimates for identical requirements. Note that the summer study did not include sufficient research funding (it should exceed that needed for the earth baseline) or development costs for the personnel OTV, HLLV launch facilities, and new earth facilities needed for manufacturing SPS components. The initial earth rectennas, which are identical, are underestimated by \$3.5B.

1975 summer study cost adjustments, which account for these missing and underestimated items, are included in Table 3-5. The 1975 costs have been escalated to 1977 levels using the GNP deflation of 11.0 percent. The basic research and rectenna costs have been adjusted (+\$8.2 B) for equivalence with the NASA baseline cost. Missing costs of \$4.3B have been added for the POTV and HLLV launch facilities. Fewer SPS hardware facilities will be required on earth for the LRU concept, so one third of the earth baseline cost, or \$3.4 B was added for this purpose. The adjusted R&D cost is \$139.7 billion, or \$53 billion more than the JSC earth resources baseline.

Table 3-4. SPS development/startup cost comparison

	Earth Resources JSC Baseline 1977 \$ (B)	Lunar Resources Summer Study 1975 \$ (B)
Basic Research	6.3	1.6
Development Costs	36.3	50.9
Heavy Lift Launch Vehicle	11.1	9.3
Personnel Launch Vehicle	1.9	*
Cargo OTV	1.7	0.4
Personnel OTV	1.5	Missing
Lunar Transfer Vehicle	N/A	1.7
Inter-Librational TV	N/A	2.0
Construction Base(s)	6.9	12.3
Processing Facilities	Incl.	16.6
Mass Driver/Catcher	N/A	6.7
Launch Facilities (KSC)	2.8	Missing
SPS Hardware Facilities	10.4	Missing
Acquisition - Startup	44.1	59.3
Transportation	13.0	34.2
Construction Base(s)	13.8	14.6
First SPS	12.8	9.5
Initial Rectennas	4.5	1.0
Total thru First Operating SPS	86.7	111.5

*Shuttle passenger version assumed available.

It must be emphasized that cost data from this 1975 analysis was generated with ground-rules and assumptions totally incompatible with those subsequently used for NASA-JSC Earth Baseline SPS Economic Analysis. Modification of this 1975 data has been limited to only the most obvious discrepancies. The only purpose for using this information is to determine non-SPS material requirements sensitivity for a low construction scenario. It is not valid for any other purpose. One interesting omission is the required mass and definition of construction materials used for the 10 GW SPS analyzed during the 1975 Summer Study. Apparently, a high percentage of lunar material utilization was assumed, which leads to the conclusion that aluminum structure is employed. Structure for the JSC Earth Baseline is graphite composite.

To determine a preliminary material requirements threshold point, SPS number 2 and on production costs must be developed. The adjusted summer study development expenditures shown in Table 3-5 yield a system capable of producing 10 GW satellite power systems at the rate of one per year. We have determined the cost of additional satellites by imposing the following assumptions on summer study analyses:

- Learning effects will be ignored.
- Only the labor related to SPS production and/or maintenance of the productive system will be counted.
- Low (ultimate) launch costs are applicable from the start.

Table 3-5 Summer study cost adjustments.

1975 Research, Development & Start-up Costs		\$111.5 B
Escalate to 1977 Costs		12.3
Add missing development (from NASA baseline):		15.9
Additional basic research	4.7	
Personnel OTV	1.5	
Launch Facilities (KSC)	2.8	
SPS hardware facilities	3.4	
Additional earth rectenna costs	3.5	
Adjusted Research & Development		\$139.7 B

These assumptions, implemented as indicated in Table 3-6, ensure that SPS costs, at \$11.865 billion, are understated for the lunar resources utilization concept.

A comparison of NASA JSC earth baseline production costs with adjusted summer study SPS production costs is shown in Table 3-7. This comparison indicates that the satellite produced from lunar resources is underestimated relative to the JSC baseline.

The material and labor costs for the satellites show the earth-based concept to be \$3 billion higher. It is likely that the lunar material satellite would be of equivalent cost, with its savings realized in transportation cost alone.

Transportation for the lunar resources concept reflects the ultimate low cost when lunar oxygen propellants and second generation launch vehicles are available.

The lowest conceivable threshold point can now be determined by combining cost data from Tables 3-4 through 3-7.

Table 3-6 Adjusted Summer Study production costs for one SPS per year.

Earth Purchased SPS Parts (4.61 - 1.01)	\$3.600 B
Transportation	.660
2950 MY (@ L ₅)	1.393
System Maintenance & Operation	1.028
1975 Costs	6.681
Escalate to 1977 costs	.738
Add Rectenna	4.446
Adjusted Second Unit SPS Cost	\$11.865 B

Table 3-7 SPS unit cost comparison (1977 \$B)

	JSC Baseline	Summer Study (Mod)
Earth-produced satellite parts	7.141	3.997
In-space fabrication & assembly	1.216	1.340
Subtotal Materials & Labor	8.357	5.337
Transportation	10.089	2.082
Satellite Subtotal	18.446	7.419
Ground System (Rectennas)	4.446	4.446
TOTAL	\$22.892 B	\$ 11.865 B

Costs to develop and produce Satellite Power Systems from earth and lunar materials are plotted in Figure 3-2, as a function of the number of satellites produced. Learning effects have been ignored to ensure that the breakeven point is understated. If learning were included, the plotted cumulative cost lines would show lower costs as more satellites are produced. The JSC baseline, with higher unit cost, would curve more sharply, and the crossover point would move to the right. If 80% learning was attainable for both concepts the crossover would occur at about 8 units.

This comparison, shown in Figure 3-2, indicates that at least an equivalent of 5.8 10 GW SPS, or approximately 565,000 tons of material, is required to consider lunar resource utilization. This means that the low scenario of Table 3-3 must be increased by a factor of 9, or combined with material requirements for other satellites such as SPS, to meet this preliminary nominal threshold point criteria.

Perhaps world conditions and satellite service requirements will improve more rapidly than expected and the low scenario developed in Table 3-3 will prove to be conservative. It is difficult to envision, however, that satellite quantities shown could more than double, which would still fall far short (22 percent) of the preliminary nominal threshold point. Thus a mix of SPS and satellites from Table 3-3 must be used to attain even the very optimistic minimum material requirements.

When developing a low scenario which combines SPS and these smaller service satellites, some selectivity must be used to eliminate possible inconsistencies. For instance, with satellite power systems included in the low missions scenario, the possible need for night illuminators (CS-6) and power relay satellites (CS-15) is reduced. This is due to the fact that SPS will supply power for illuminating cities via existing street lights, and can beam the power to locations where it's most needed. It is also possible that fewer nuclear fuel locators (CO-7) will be required since SPS's will be developed instead of new fission reactors to

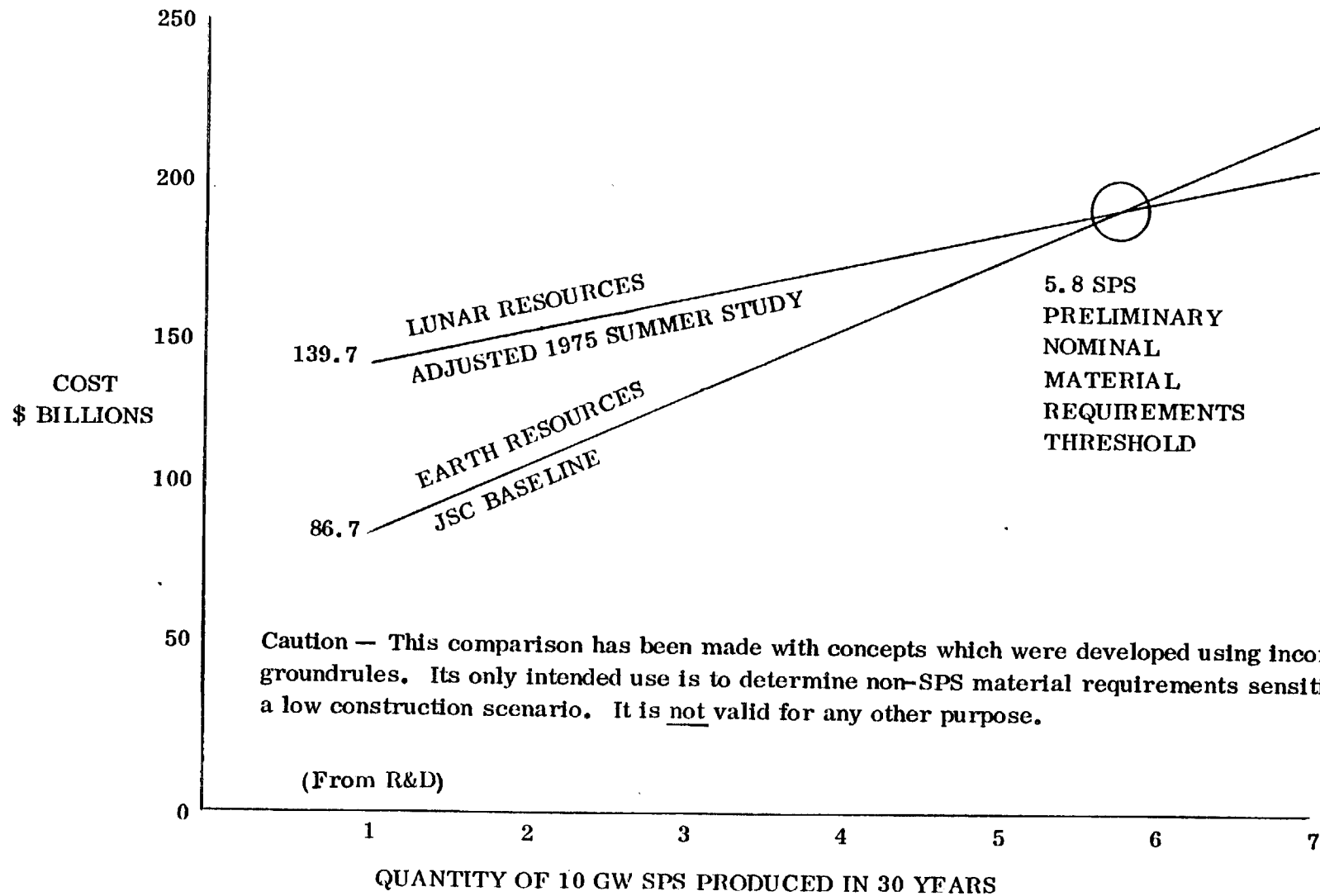

Figure 3-2. Preliminary estimate of nominal threshold point.

supply growing energy needs. However, nuclear materials will still be needed for existing reactors and other purposes, and the requirement for monitoring and safeguarding this material will not be reduced.

When the night illuminator and power relay satellite requirements are deleted from Table 3-3, the low material requirements scenario total mass is reduced from 63,230T to 29,135 T.

3.4 SATELLITE MATERIAL REQUIREMENTS (EARTH RESOURCES)

The baseline JSC satellite power system consists of the element material requirements shown in Table 3-8. These have been accumulated in Table 3-9 to demonstrate the percent requirement for each particular material per 10 GW satellite.

A similar material estimate for earth service satellites used in the low mission scenario has not previously been accomplished. Enough data exists, however, to conduct a very preliminary assessment of these material needs. This estimate, shown in Table 3-10, employs power requirements and antenna area requirements from the Aerospace Corporation report (See Table 3-1) to determine solar cell mass (glass and silicon) and composite structure mass. The remaining mass identified as "other materials" will include metals, sensors, avionics, and propulsion equipment. This mass has been allocated as shown in Table 3-11 with metals comprising an estimated 18 percent of the total low scenario mass.

Comparison of the mass percentages for SPS in Table 3-9, with those for the low scenario in Table 3-11, results in some interesting conclusions.

- 1) The SPS is a power intensive satellite system:

$$\left(\frac{\text{Power}}{\text{Unit Mass}} \right)_{\text{SPS}} = \frac{17,000,000 \text{ kW}}{97,550 \text{ T}} = 174.3 \text{ kW/T}$$

$$\left(\frac{\text{Power}}{\text{Unit Mass}} \right)_{\text{Low Scenario}} = \frac{102,444 \text{ kW}}{29,135 \text{ T}} = 3.5 \text{ kW/T}$$

Table 3-8. 10 GW satellite system materials requirements *

<u>Element</u>	<u>Material</u>	<u>Mass (T)</u>
Energy Collection System		
Structure	Gr-Ep	6,177
	Aluminum	619
Solar Cells	Glass	36,097
	Silicon	14,775
	Copper	1,456
	S. Steel	327
	Aluminum	2,778
Distribution	Copper	116
	S. Steel	67
	Silver	28
Misc. Components	Various	3,209
Power Transmission System		
Structure	Gr-Ep	894
	Aluminum	1,850
Controls	Copper	1,761
	S. Steel	3,449
	Mercury (1)	266
	Aluminum	1,077
	Copper	1,686
Instrumentation/Buss	S. Steel	1,686
	Gr-Ep	5,462
	Copper	5,755
Antenna Subarrays	S. Steel	2,218
	Tungsten	1,132
	Various	4,665
Misc. Components		
	TOTAL	97,550

(1) Closed System Heat Pipe Application Only

NOTE: Undefined component mass 7,874 T, or 8% of total mass of SPS

* Data Source: A recommended preliminary baseline concept, SPS concept evaluation program, NASA JSC January 25, 1978

Table 3-9. SPS earth material requirements summary *

	Mass (T)	Percent
Glass (Fused Silica)	36,097	37
Silicon Solar Cells	14,775	15
Graphite Composite	12,533	13
Copper	10,774	11
Stainless Steel	7,747	8
Aluminum	6,324	7
Tungsten	1,132	1
Mercury	266	-
Silver	28	-
Various	7,874	8
	<hr/>	<hr/>
TOTAL (PER SATELLITE)	97,550	100

* Compiled from data shown in Table 3-8.

Table 3-11. Low scenario earth material requirements summary

	Mass (T)	Percent
Glass (Fused Silica)	438	> 1
Silicon Solar Cells	183	< 1
Graphite Composite	9,569	33
Copper	500	2
Stainless Steel	1,500	5
Aluminum	3,120	11
Various	13,825	47
	<hr/>	<hr/>
TOTAL (SCENARIO)	29,135	100

Table 3-10. Estimated earth material requirements for modified low scenario satellites other than SPS

Satellite Designation	30 Year Qty.	Total ⁽¹⁾ Power (kW)	Total Area (m ²)		Mass (T)				
			Solar ⁽²⁾ Array	Antenna ⁽¹⁾	Silica ⁽³⁾ Glass	Silicon ⁽⁴⁾ Cells	Graphite ⁽⁵⁾ Composite	Other ⁽⁶⁾ Materials	Total ⁽⁷⁾
PSP-1	20	90	556	6,800	< 1	< 1	4	292	298
PSP-2	10	12,280	75,800	1,034,000	52	22	576	682	1,332
CO-7	80	24	148	12,000	< 1	< 1	7	100	109
CS-13	60	30	185	9,000	< 1	< 1	5	102	109
CC-1	20	20	123	200	< 1	< 1	< 1	11	14
CO-9	30	90,000	555,600	33×10 ⁶	382	157	8,976	17,758	27,273
TOTALS		102,444	632,400	34.06×10 ⁶	438	183	9,569	18,945	29,135

(1) Obtained from data in Table 3-1

(2) Based on SPS photovoltaic array specific power of 162 W/m²

(3) Based on twice the SPS silica glass thickness, or 0.688 kg/m²

(4) Based on twice the SPS silicon cell thickness, or 0.282 kg/m²

(5) Based on four times the SPS support structure weight for arrays (0.236 kg/m²) plus twice GDC's expandable truss structural weight for antennas (0.54 kg/m²) except for CO-9 which uses twice SPS support structure for arrays (0.118 kg/m²) and the expandable truss structural weight for antennas (0.27 kg/m²)

(6) Remainder: Total in column (7) minus combined quantities (3), (4) & (5)

(7) Obtained from Table 3-3

Therefore, while SPS material requirements are dominated by the photovoltaic array (approximately 65 percent) solar array material requirements are insignificant for the low scenario satellites (approximately 4 percent)

2) The low scenario satellites are dominated by their antenna requirements:

$$\left(\frac{\text{Antenna Area}}{\text{Unit Mass}} \right)_{\text{SPS}} = \frac{2,438,000 \text{ m}^2}{97,550 \text{ T}} = 25 \text{ m}^2/\text{T}$$

$$\left(\frac{\text{Antenna Area}}{\text{Unit Mass}} \right)_{\text{Low Scenario}} = \frac{34,062,000 \text{ m}^2}{29,135 \text{ T}} = 1169 \text{ m}^2/\text{T}$$

Thus, key low scenario material requirements include graphite composite antenna structure, 32 percent, and various electronics sensors and controls, 47 per cent. The corresponding combined SPS requirements contribute only 9 percent.

An overall comparison of two possible low scenarios at the preliminary nominal threshold point is presented in Table 3-12. The scenario on the left consists entirely of solar power satellites. The other low scenario consists of a combination of SPS's and those satellites identified in Table 3-10. The total mass of both options is the same, and equals the minimum material requirements threshold point equivalent to 5.8 SPS's as developed in Figure 3-2. The right hand column of Table 3-12 shows the percent variation of material requirements for SPS scenarios with and without other earth servicing satellites. The maximum variation identified is two percent. For intermediate and high material scenarios, the percent variations will become significantly smaller. Based on this analysis, it is evident that if SPS material requirements are exclusively used over the entire mission scenario range, the maximum error for any specific material requirement will be only two percent. This error is well within our current ability to predict actual SPS material requirements, and is therefore insignificant.

Table 3-12. Comparison of low scenario material requirements

Material Requirements	Quantity of 5.8 SPS No Other Satellites		Quantity of 5.5 SPS Plus Low Scenario				Percent Variation
			Mass for 5.5 SPS (T)	Mod. Low Scenario Mass (T)	Combined Mass (T)	Total Percent	
	Mass (T)	Percent					
Glass	209,315	37.0	198,534	438	198,972	35.2	-1.8
Silicon Cells	85,675	15.2	81,263	183	81,446	14.4	-0.8
Graphite Comp.	72,675	12.8	68,931	9,569	78,500	13.9	+1.1
Copper	62,475	11.0	59,257	500	59,757	10.6	-0.4
Stainless Steel	44,922	7.9	42,608	1,500	44,108	7.8	-0.1
Aluminum	36,671	6.5	34,782	3,120	37,902	6.7	+0.2
Tungsten	6,564	1.2	6,226	--	6,226	1.1	-0.1
Mercury	1,542	0.3	1,463	--	1,463	0.3	--
Silver	162	--	154	--	154	--	--
Various	45,659	8.1	43,307	13,825	57,132	10.1	+2.0
TOTALS	565,660	100	536,525	29,135	565,660	100	

To summarize, we recommend that SPS material requirements as a function of SPS construction rate be used exclusively throughout the mission scenario range, because:

- 1) In the worst case (lowest conceivable threshold point), material requirements vary by a maximum of two percent due to inclusion of an optimistic scenario of SPS compatible earth service satellites.
- 2) The actual threshold point developed by subsequent study tasks is expected to be somewhat greater than the optimistic 5.8 SPS's obtained by using Space Settlements Summer Study data. This higher threshold will further reduce the material requirements variance caused by other non-solar power satellites.
- 3) If other than SPS material requirements are included, their replacement by lunar resources is unlikely since almost 80 percent of their needs must be satisfied by earth materials and products such as graphite composite and complicated electronics equipment.
- 4) Since the low scenario without SPS is very optimistic, we are convinced that SPS (or a yet-to-be identified equivalently massive substitute) will have to be included in the intermediate scenarios. For example, with JSC's Ref. 5 SPS scenario B (112 satellites) used for the high scenario, intermediate scenarios might include quantities of 75 (67 percent) and 37 (33 percent) satellite power systems. Addition of those satellites in Table 3-10 (or even ten times as many) to these intermediate/high scenarios will have an insignificant effect on overall material percentage requirements.
- 5) Since multiple SPS's will dominate both the high and intermediate scenarios it would be very useful in determining the cost effectiveness point to have constant SPS material percentages extend to the lower scenario. We therefore recommend that SPS material percentages apply throughout the entire scenario range.

3.5 SA TELLITE MATERIAL REQUIREMENTS (LUNAR RESOURCES)

The replacement of satellite power system components manufactured from earth resources, with those made primarily from lunar resources, was evaluated via a multi-step procedure:

- 1) The specific earth material used for each SPS component or application, and the performance requirements which resulted in the selection of this material must be established.
- 2) Suitable SPS component substitutes which contain a reasonably high percentage of lunar materials and will satisfy most (or all) of the baseline component's performance requirements must be postulated. The equivalent quantity of this substitute lunar material needed to meet earth baseline performance requirements must be determined.
- 3) Those components for which this substitution can be reasonably made must be selected. This material replacement can occur in successively more difficult steps as shown in Figure 3-3. NASA-JSC participation in determining the degree of acceptable substitution difficulty is included in this selection process.

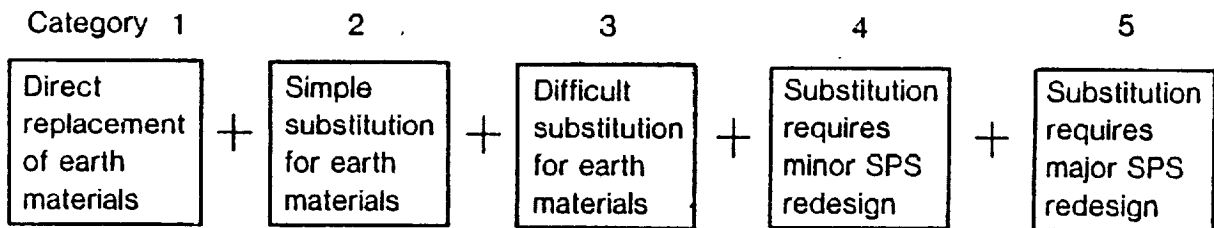

Figure 3-3. Steps for lunar material substitution.

- 4) Determine the corresponding lunar and earth material requirements for a Satellite Power System constructed primarily with lunar resources.

3.5.1 Characterization of SPS Earth Material Requirements

Development of lunar resource requirements for the satellite power system requires greater understanding of the earth baseline material performance characteristics than exhibited by Table 3-8.

To obtain an improved understanding of specific SPS material applications, the matrix shown in Table 3-13 was generated using satellite mass summary data and material requirements summary data obtained from "A recommended preliminary baseline concept, SPS concept evaluation program", NASA JSC January 25, 1978, plus information from volumes III, IV and VI of the Boeing SPS System Definition Study, Part II (References 6, 7, and 8). Appendix A of Volume III includes the data sheets with specific source information from which these material estimates were generated.

Some discretion was employed in completing the matrix in Table 3-13 to provide reasonable agreement with the NASA-JSC documented totals and the 26.7 percent material margin. As indicated by the footnotes, the material requirements for CRES and aluminum required margins significantly different than the identified composite margin of 26.7 percent. Based on this compilation, it appears that aluminum requirements have been slightly underestimated. CRES requirements appear to be overestimated, but CRES heat pipe material needs may make this allocation acceptable. Masses of discrete components are ranked in Table 3-13 by use of alphabetic superscripts.

These components plus smaller amounts of similar components and material margins are listed in Table 3-14. Also shown is the specific application for which these materials are used, and the performance requirements responsible for their selection. As indicated in Table 3-14, fifteen discrete material products, each contributing at least 1.2 percent of total SPS mass, total 90.0 percent of the earth baseline SPS material requirements.

3.5.2 Lunar Resource Material Substitution

Each earth material application in Table 3-14 must be investigated to determine reasonable alternative methods of providing the same function with lunar derived materials. This investigation included development of equivalent material

Table 3-13. SPS earth material requirements mass breakdown.

SPS Components	Fused Silica Glass	Silicon Solar Cells	Graphite Comp	Copper	CRES	Alum	Other Metals	Various	(Ref Table X-1) Total
SOLAR ARRAY									
Primary Structure			(d) 4,900			485			5,385
Rotary Joint (Mechanical)			(o) 60			4		3	67
Flight Control System									
Thrusters					47				} 179
Mechanical Systems				(e) 8	32				
Conductors									
Power Processors								88	
Avionics (Instr. Comm. Computers)								4	
Energy Conversion System									
Solar Cells	(a)(c) 11,671	(b) 11,671							} 43,750
Substrate and Covers	(a)(c) 28,313			(n) 1,150					
Interconnects									
Joint/Support Tapes									
Catenary	(a)(c) 181				258				
Tolerance & Other					258			1,919	
Power Distribution									
Power Busses				(e) 39		(h) 2,030			} 2,398
Cell String Feeders								156	
Disconnects and Switchgear								20	
Energy Storage								15	
Rotary Joint (Electrical)			(o) 1				(Ag) 23		
Support Structure			(o) 114						
MICROWAVE POWER TRANSMISSION SYSTEM									
Antenna Structure									
Primary Structure			(o) 105						} 500
Secondary Structure			(o) 395						
Antenna Control System									
MPTS Power Distribution									
Power Busses						(h) 760			} 5,866
Switchgear and Disconnects				(e) 868	(k) (Fe) 844	(l) 50		274	
DC-DC Converters						(l) 1,188		720	
Thermal Control								284	
Energy Storage								599	
Support Structure			(o) 279						
Subarrays									
Waveguides			(f) 4,149	(e)(j) 4,542	(k) (m) 1,747	(l) 165			} 18,846
Klystrons				(l) 1,215	(g) 1,926	(l) 767	(W) 893	2,134	
Thermal Control				(e) 698			(Hg) 266		
Control Circuits and Cables								344	
Margin (~26.7%)	7,603	3,104	2,530	2,254	(l) 2,635	(2) 875	(g) 244	(4) 1,303	20,548
TOTAL (Ref Table 3-9)	36,097	14,775	12,533	10,774	7,747	6,324	1,426	7,874	97,550

(1) 51.5%, (2) 16.1%, (3) 20.6%, (4) 19.8%

Table 3-14. SPS earth material mass ranking and application.

RANK	MASS (T)	PERCENT OF TOTAL SPS MASS	MATERIAL	APPLICATION	PERFORMANCE REQUIREMENTS
(a)	21,658	22.2	Borosilicate Glass	Photovoltaic Cell Covers	Structural Support, UV Stability, Emittance, Radiation Protection
(b)	14,775	15.1	Silicon	Solar Cells	Energy Conversion Efficiency, Radiation & Thermal Degradation
(c)	14,439	14.8	Fused Silica Glass	Photovoltaic Cell Substrate	Structural Support, Thermal Control
(d)	6,208	6.4	Graphite Composite	Primary Structure for Solar Array	Structural Stiffness, Buckling Strength, Thermal Stability
(e)	5,980	6.1	Copper Wire	Klystron & DC-DC Converter Coils, Power Cables	Electrical Conductivity, Resistance, Field Strength
(f)	5,257	5.4	Graphite Composite	MPTS Waveguides	Microwave Transmission, Dimensional and Thermal Stability
(g)	3,892*	4.0	CRES Tubing	Heat Pipe for Klystron Radiators	Contain Mercury Transport Fluid, High Temperature
(h)	3,535	3.6	Aluminum Sheet	Power Transmission Busses, Array & MPTS	Electrical Conductivity
(i)	2,749	2.8	Aluminum Sheet	Klystron & DC-DC Conv. Radiators	Thermal Conductivity, Surface Emissivity
(j)	1,820	1.9	Copper (Mach Part)	Klystron Solenoid Cavity	Electrical Conductivity, Non-Magnetic, Mercury Compatibility
(k)	1,758	1.8	Iron	Klystron Solenoid & Transformer for DC-DC Converter	Magnetic Properties
(l)	1,539	1.6	Copper Sheet	Klystron Collector Radiators	Thermal Conductivity, Surface Emissivity, High Temperature
(m)	1,524	1.6	CRES (Mach Part)	Klystron Housing	Non-Magnetic, High Temperature
(n)	1,456	1.5	Vacuum Deposited Copper	Solar Cell Inter-Connects	Electrical Conductivity, High Temperature for Array Annealing
(o)	1,210	1.2	Graphite Composite	MPTS Antenna & Other Structure	Structural Stiffness, Thermal Stability, Electrical Insulator

87,800 T 90.0% of Total 97,550 T Earth Baseline SPS

* $\left[(2,636 - 266)^{\text{From X. 2}} + (1522)^{\text{From X. 4}} \right] 1.00 \text{ Margin}$

requirements. The following procedure was employed to obtain this information:

- 1) Determine what percentage (by weight) of the earth baseline material requirements can be directly satisfied with lunar resources.
- 2) Postulate substitute materials which will allow a higher percentage of lunar resource utilization and/or improved in-space production capability. Determine how much more of these substitute materials are required to meet the various performance requirements of the earth baseline materials, such as:

- Structural stiffness (graphite composite)
- Electrical conductivity (power busses, klystrons)
- Radiation protection (glass covers)
- Energy conversion (solar cells)
- Heat dissipation (radiators)
- Dimensional stability (MPTS waveguides)

The substitute lunar derived material mass requirements are defined by the ratio of important performance parameters:

$$\left[\frac{\text{Lunar Material Performance Parameters}}{\text{Earth Material Performance Parameters}} \right] = \left[\begin{array}{l} \text{Lunar material} \\ \text{Performance} \\ \text{Factor} \end{array} \right]$$

- 3) Determine what percentage (by weight) of these substitute lunar materials must still be obtained from earth. These earth materials include special alloying agents, adhesives, and other substances which cannot be derived from lunar resources.

Details of results obtained by this procedure for each of the fifteen material utilization categories is contained in Appendix A of Volume III. The material substitutions shown in Table 3-15 were recommended to achieve maximum utilization of elements available in lunar soil. Aluminum was substituted

for copper and corrosion resistant steel (CRES) when material compatibility and operating temperature requirements were acceptable. Foamed glass was selected as a substitute for graphite composite structure and waveguide applications. Postulation of a low density lunar ceramic (foamed glass) as suitable SPS structure was based on the theoretical attributes of this material, especially its low coefficient of thermal expansion. Extensive experimentation and technology development may be required to obtain such a material. Many SPS components, especially solar cells, can be manufactured using lunar derived glass and silicon for direct replacement of earth materials.

Table 3-15. Recommended lunar material substitutions.

Category	Percent
<div style="border: 1px solid black; padding: 5px;"> Direct replacement of earth materials </div>	<ul style="list-style-type: none"> • Aluminum for power busses & radiators • Silicon for solar cells • Fused silica glass for solar cell substrate • Iron for Klystron poles & transformer core <div style="text-align: right; margin-right: 20px;">} 38.1</div>
<div style="border: 1px solid black; padding: 5px;"> Simple substitution for earth materials </div>	<ul style="list-style-type: none"> • Fused silica for borosilicate glass solar cell covers • Aluminum for copper wire & interconnects • Aluminum for copper radiators <div style="text-align: right; margin-right: 20px;">} 31.4</div>
<div style="border: 1px solid black; padding: 5px;"> Difficult substitution for earth materials </div>	<ul style="list-style-type: none"> • Alloy steel for CRES heat pipes • Copper coated aluminum for copper Klystron cavity • Aluminum for CRES Klystron cavity <div style="text-align: right; margin-right: 20px;">} 7.5</div>
<div style="border: 1px solid black; padding: 5px;"> Substitution requires minor SPS redesign </div>	<ul style="list-style-type: none"> • Foamed glass for graphite composite structure • Foamed glass for graphite composite waveguides <div style="text-align: right; margin-right: 20px;">} 13.0</div>

The recommended lunar material substitutions have been compiled in Table 3-16 for each of the fifteen SPS applications. Substitute material replacement mass factors vary from 0.338 for replacing the CRES klystron housing with aluminum, to 2.0 for replacing graphite composite structure with foamed glass. The total mass derived from lunar material is 88,190 T which requires an additional 440 T of earth supplied alloying materials. This total material quantity (88,630 T) provides the same functions as the 87,800 T of earth baseline SPS materials. The special earth baseline materials (Ag, W, Hg) and electronic components (various) must still be supplied from earth for the SPS constructed primarily with lunar resources. This earth supplied material has a mass of $97,550 - 87,800 = 9,750$ T for each SPS, resulting in a total SPS mass of 98,380 T. Lunar materials employed for SPS construction are produced from only four elements; silicon, oxygen, aluminum and iron.

3.5.3 EVALUATION OF SUBSTITUTE LUNAR MATERIALS. Fifteen material categories have been identified which constitute 90 percent of the earth baseline SPS mass. From the results of our analyses in 3.5.2, it appears that suitable replacement or substitute lunar materials may be available to satisfy the requirements of virtually all these applications. However, the uncertainty or difficulty of effecting some of these substitutions may make complete replacement with lunar materials unwise. This section evaluates the propriety of accepting all of these proposed substitutions.

Each of the fifteen categories (a through o) have been assessed for their applicability to seven qualitative evaluation criteria in Table 3-17. Ranking has been accomplished on a scale of 1 to 5 for each of these criteria. A low numerical score indicates simple adaptability and high numerical score indicates difficult adaptability and/or a high degree of uncertainty.

These numerical adaptability rankings can also be expressed in terms of direct replacement, simple substitution, difficult substitution, and require satellite redesign, as described in the introduction to Section 3.5 on pages 3-21. Table 3-17 also

Table 3-16. Compilation of SPS substitute lunar materials.

Earth Baseline Satellite Power System					Lunar Replacement Materials (T) For SPS						Earth Constituent Mat'l. Mass (T)	TOTAL (T)
Rank	Mass (T)	Mass (%)	Material	Application	Silica Glass	Pure Silicon	Aluminum	Iron	Other	TOTAL		
(a)	21,658	22.2	Borosilicate Glass	Photovoltaic Cell Covers	21,658					21,658	0	21,658
(b)	14,775	15.1	Silicon	Solar Cells		14,775				14,775	≪ 1	14,775
(c)	14,439	14.8	Fused Silica Glass	Photovoltaic Cell Substrate	14,439					14,439	0	14,439
(d)	6,208	6.4	Graphite Composite	Primary Structure for Solar Array	12,404				(O ₂)12	12,416	0	12,416
(e)	5,980	6.1	Copper Wire	Klystron & DC-DC Converter Coils, Power Cables			2,865			2,865	0	2,865
(f)	5,257	5.4	Graphite Composite	MPTS Waveguides	5,252				(O ₂) 5	5,257	0	5,257
(g)	3,892	4.0	CRES Tubing	Heat Pipe for Klystron Radiators				3,542		3,542	350	3,892
(h)	3,535	3.6	Aluminum Sheet	Power Transmission Busses, Array & MPTS			3,535			3,535	0	3,535
(i)	2,749	2.8	Aluminum Sheet	Klystron & DC-DC Conv. Radiators			2,749			2,749	0	2,749
(j)	1,820	1.9	Copper (Mach Part)	Klystron Solenoid Cavity			785			785	90	875
(k)	1,758	1.8	Iron	Klystron Solenoid & Transformer for DC-DC Converter				1,758		1,758	0	1,758
(l)	1,539	1.6	Copper Sheet	Klystron Collector Radiators			779			779	0	779
(m)	1,524	1.6	CRES (Mach Part)	Klystron Housing			515			515	0	515
(n)	1,456	1.5	Vacuum Deposited Copper	Solar Cell Inter-Connects			697			697	0	697
(o)	1,210	1.2	Graphite Composite	MPTS Antenna & Other Structure	2,418				(O ₂)2	2,420	0	2,420
TOTAL MASS (T)					56,171	14,775	11,925	5,300	19	88,190	440	88,630
PERCENTAGE OF EARTH BASELINE MASS					57.6	15.2	12.2	5.4	-	90.4	0.5	90.9

3-16

Table 3-17. Assessment of lunar material substitutes.

RANKING

- 1 - No Problems Introduced
- 2 - Slight Problems
- 3 - Moderate Problems
- 4 - Severe Problems
- 5 - Very Severe Problems

Qualitative Evaluation Criteria

Categories

Rank	SPS Application	Earth Baseline Material	Recommended Lunar Substitute Material	Ease of Material Substitution	Ease of Component Manufacture	Ease of Subsystem Integration	Material Compatibility	Temperature	Compatibility	Overall Design Uncertainty	Overall SPS Design Influence	Average	Categories					
													1	2	3	4	5	
													Direct Replacement of Earth Materials	Simple Substitution For Earth Materials	Difficult Substitution For Earth Materials	Substitution Requires Minor SPS Redesign	Substitution Requires Major SPS Redesign	
a	Photovoltaic Cell Covers	Borosilicate Glass	Fused Silica Glass	1	2	1	1	1	1	1	1	1.1		X				
b	Solar Cells	Silicon	Silicon	1	1	1	1	1	1	1	1	1.0	X					
c	Photovoltaic Cell Substrate	Fused Silica Glass	Fused Silica Glass	1	1	1	1	1	1	1	1	1.0	X					
d	Primary Solar Array Structure	Graphite Composite	Foamed Silica Glass	4	4	3	2	1	5	4	4	3.3				X		
e	Solenoid/Coil Windings Etc.	Copper Wire	Aluminum Wire	1	1	1	2	3	2	2	2	1.7		X				
f	MPTS Waveguides	Graphite Composite	Foamed Silica Glass	4	4	4	2	2	5	4	4	3.6				X		
g	Klystron Heat Pipes	CRES Tubing	CRES in Klystron, Low Alloy Steels Elsewhere	3	2	2	3	2	2	2	2	2.3			X			
h	Power Transmission Busses	Aluminum Sheet	Aluminum Sheet	1	1	1	1	1	1	1	1	1.0	X					
i	Klystron/DC-DC Conv. Radiators	Aluminum Sheet	Aluminum Sheet	1	1	1	1	1	1	1	1	1.0	X					
j	Klystron Solenoid Cavity	Copper Mach. Part	Copper Coated Aluminum Aluminum Cast & Mach.	3	3	3	4	3	3	3	3	3.1			X			
k	Klystron Poles, DC-DC Transformer	Iron Mach. Part	Iron Mach. Part	1	2	1	1	1	1	1	1	1.1	X					
l	Klystron Collector Radiators	Copper Sheet	Aluminum Sheet	1	1	1	3	3	2	3	3	2.0		X				
m	Klystron Housing	CRES Mach. Part	Aluminum Cast & Mach.	2	2	2	3	3	3	3	3	2.6			X			
n	Solar Cell Interconnects	Copper Vac. Deposited	Aluminum Vac. Deposited	1	1	1	1	2	1	1	1	1.1		X				
o	MPTS Antenna Structure	Graphite Composite	Foamed Silica Glass	4	4	4	3	2	5	4	4	3.7				X		

3-2-6

organizes the data into this format.

The five direct replacement applications (b, c, h, i, and k) obtain all their material requirements from lunar resources. This lunar derived silicon, silica glass (SiO_2), aluminum, and iron constitutes 38.2 percent of the earth baseline.

The second category, "simple substitution for earth materials," includes four applications (a, e, l and n) which use 100 percent lunar resources which are substituted for functions supplied in the earth baseline SPS by materials not available on the moon. These substituted lunar materials, silica glass and aluminum, plus the materials in category 1, comprise 64.8 percent of the earth baseline SPS mass.

The third category includes those substitutions which are more difficult to accomplish due to a combination of performance requirements not ideally suited for lunar materials. When the lunar iron and aluminum in g, j and m is included, the combined category 1 through 3 materials are equivalent to 69.8 percent of the earth baseline SPS mass. Some earth alloys (Cr, Ni, Cu) must be used in conjunction with these lunar metals to meet performance requirements.

The fourth category includes the graphite composite applications, for which foamed silica glass has been substituted. This substitution may not actually be very difficult, but little experience with this proposed material and its application is available, which results in a high degree of uncertainty. By combining all four categories, 90.4 percent of the earth baseline SPS material requirements are satisfied with lunar materials. It is important to note, however, that the total SPS mass increases slightly when lunar glass structure is substituted for earth graphite composite, so the lunar derived materials only constitute 89.6 percent of the revised total SPS mass.

The final category "substitution requires major SPS redesign", did not correspond to any of the fifteen material applications investigated.

Although higher category designations indicate increased difficulty in implementing lunar material substitutions, all of these substitutions should be feasible if reasonable technology developments are pursued. We have therefore recommended that all fifteen candidate SPS applications (a through o) be implemented with lunar resource substitutions.

3.5.4 LUNAR RESOURCE SPS MATERIAL REQUIREMENTS. Table 3-18 summarizes the lunar and earth material requirements for each lunar resource 10 GW SPS as a function of the category selection level.

It is interesting to note that total SPS mass increases due to the substitution of foamed silica glass for graphite composite, but is reduced by aluminum substitution for copper and CRES.

Although the maximum lunar resource utilization is recommended, the LRU material percentages for lesser utilizations are included in Table 3-18. The total lunar resource utilization drops from 89.6 percent → 68.1 percent as materials from categories 3 and 4 (see Table 3-17) are deleted.

The satellite power system material rate requirements are determined by multiplying the SPS production rate per year by the mass values contained in Table 3-18. In summary, 90.4 percent of the original baseline earth requirements are satisfied with lunar derived materials, and 10.5 percent must still come from earth, resulting in a lunar resource SPS 1.009 times more massive than the earth baseline, with a 89.6/10.4 lunar/earth material ratio.

The material requirements for maximum lunar resources utilization shown in Table 3-18 were used as input data to develop steady state material logistics scenarios in Task 5.3.

Table 3-18. Lunar Resource SPS Material Requirements

		Max Lunar Utilization All Categories		Delete Category 4 (Composite Replacement)		Delete Cat. 3 & 4 (Composite & Klystron)	
		Mass (T)	Percent of Total	Mass (T)	Percent of Total	Mass (T)	Percent of Total
Lunar Material Requirements	Silicon	41,033	41.7	31,649	34.8	31,649	34.1
	Oxygen	29,932	30.4	19,223	21.1	19,223	20.7
	Aluminum	11,925	12.1	11,925	13.1	10,625	11.4
	Iron	5,300	5.4	5,300	5.8	1,758	1.9
Total Lunar Material		88,190	89.6	68,097	74.9	63,255	68.1
Earth Material Requirements	Metals	2,316	2.4	2,316	2.5	9,112	9.8
	Graphite Composite	0	0	12,675	13.9	12,675	13.6
	Various	7,874	8.0	7,874	8.7	7,874	8.5
Total Earth Material		10,190	10.4	22,865	25.1	29,661	31.9
Total SPS Mass (T)		98,380	-	90,962	-	92,916	-
Percent of Earth Baseline SPS Mass		100.9		93.2		95.2	

Subsequent work performed as part of Task 5.3 resulted in updated SPS material requirements. The results of this work are presented in Section 4.4.7 of this final report volume. The updated SPS material requirements include estimates of the non-recoverable losses of both lunar and earth supplied materials occurring in the various stages of converting metallic and nonmetallic elements into stock materials, parts, components and subassemblies. This updated material requirements data resulted in an increase of 19.8 percent in lunar material requirements, and an increase of 22.6 percent in earth material requirements. Although unrecoverable materials were responsible for some of this increase, revised foamed glass requirements and other material quantity changes in the completed LRU solar power satellite were major contributors. The updated SPS mass for construction with lunar materials is 112,220 T, with 101,920 T manufactured from lunar material and 10,300 T obtained from earth. This represents an increase of 15 percent in completed satellite mass from the 97,550 T reference earth baseline.

REFERENCES

1. Bekey, I., Mayer, H. L., and Wolfe, M. G., "Advanced Space System Concepts and Their Orbital Support Needs (1980-2000)," April 1976, Report No. ATR-76 (7365)-1, Contract NASW 2727, The Aerospace Corporation.
2. Johnson, R. D., et al, "Space Settlements, A Design Study," NASA SP-413, NASA Scientific Technical Information Office, Washington, D. C., 1977.
3. Hopkins, M. M., "A Preliminary Cost Benefit Analysis of Space Colonization," Journal of the British Interplanetary Society, Vol. 30, No. 8, August 1977.
4. Anom.: "Satellite Power System (SPS) Concept Evaluation Program, A Recommended Preliminary Baseline Concept," January 25, 1978 Briefing Brochure, NASA Johnson Space Center, Houston, Texas.
5. Anom.: "Solar Power Satellite Concept Evaluation" July 1977 Activities Report No. JSC-12973, NASA Johnson Space Center, Houston, Texas.
6. Anom.: "Solar Power Satellite System Definition Study," Part II, Volume III, SPS Satellite Systems, Report No. D180-22876-3, Boeing Aerospace Company, Seattle, Washington, December 1977.
7. Anom.: "Solar Power Satellite System Definition Study," Part II, Volume IV, Microwave Power Transmission Systems, Report No. D180-22876-4, Boeing Aerospace Company, Seattle, Washington, December 1977.
8. Anom.: "Solar Power Satellite System Definition Study," Part II, Volume VI, Evaluation Data Book, Report No. D180-22876-6, Boeing Aerospace Company, Seattle, Washington, December 1977.

4

LUNAR UTILIZATION SYSTEMS CONCEPTS DEFINITION (TASK 5.3)

TASK — Develop and define system concepts for the utilization of lunar resources for manufacturing structures in space. These system concepts shall include the location of lunar materials processing and manufacturing, the support requirements of infrastructure (such as lunar and space bases) and the material and crew transportation systems required. Transportation systems considered for transferring material from the lunar surface shall include electromagnetic "mass drivers" with associated "mass catchers," reaction engine systems using lunar material for propellants, and rocket systems utilizing lunar surface derived oxygen with earth-supplied hydrogen fuel. For each lunar utilization concept, characterize the material that is transferred between the mining location on the moon and the manufacturing location, which may be either on the lunar surface or at a suitable orbital location in space.

This task also encompasses the preparation of preliminary cost estimates for development, acquisition, and operation of equipment required to implement lunar resource utilization concepts. These cost estimates are reported in Section 5 in conjunction with other economic analysis related study tasks.

APPROACH — This task comprises the major activity of the LRU study. It encompasses systems definition, systems development, systems analyses, and systems comparison of alternative lunar resource utilization concepts. Its importance to comparative assessment of LRU concepts with an Earth Baseline is vital since the cost effectiveness threshold may be extremely sensitive to LRU systems techniques. Innovative systems concepts were evaluated in determining this threshold sensitivity with the goal of developing a reasonable low threshold point. The approach to LRU systems concept definition includes concept generation, definition of all major concept system elements, and their integration into total systems. Each

representative LRU system includes processing/manufacturing elements, transportation elements, and infrastructure support elements. Definition includes preliminary conceptual design, performance characteristics, and element mass. Considerations include the location of lunar materials processing and manufacturing facilities.

The elements comprising these LRU systems concepts must be developed, emplaced, and started up in an integrated manner to provide a smooth flow of the materials required for satellite construction. Elements will be integrated into total systems concepts to aid preliminary cost estimates for system development, acquisition, start-up, production and maintenance operations.

Definition of alternative lunar resources utilization system concepts was accomplished for comparison with the reference Earth Baseline SPS construction scenario. Their definition and assessment was conducted in five steps:

- Definition of representative techniques for utilizing lunar resources to construct solar power satellites. Three generalized options were postulated which represent a broad spectrum of alternatives comprising space based, lunar based, and combination lunar/space based manufacturing scenarios.
- Iteration of these generalized options via steady state earth material requirements to define an explicit competitive LRU concept representative of each. This was followed by development of detailed steady state material logistics scenarios for each concept. The logistics scenarios provided sizing data for the major system elements needed to process and transport SPS construction materials, propellants, and personnel.
- Definition of major system elements. The processing and manufacturing, transportation, and infrastructure support elements of each LRU concept were defined. Material processing covers those activities from mining of raw materials through final assembly of usable end items. Transportation is a major element since the material processing activities occur at various locations in the earth-space-moon environment. Both personnel and material must be

transported between activity sites. Infrastructure support elements encompass all other facilities necessary to accomplish the material processing and transportation activities, such as habitats, propellant depots, and power plants.

- Description of the lunar material flow and composition from surface mining through its combination with earth components to construct a solar power satellite.
- Generation of start-up scenarios for delivering all space facilities, vehicles, initial supplies, initial propellants, and personnel to proper locations and placing them on operational status to support steady state production.

4.1 DEFINITION OF ALTERNATIVE LRU IMPLEMENTATION OPTIONS

Lunar resource utilization (LRU) is an approach in which lunar materials are used for the construction of large space structures in high earth orbit. A major objective of this study is the comparison of LRU system concepts with a conventional baseline concept for satellite construction using earth resources. By comparing the lunar resource utilization concepts with the earth baseline, similar and unique system element requirements become readily apparent. To properly meet this objective it is necessary to understand and define total LRU system concepts.

A LRU system concept must contain all the elements required to conduct the activities involved in a space construction program. The activity categories are material processing, transportation, and support. Material processing covers those activities from mining of raw materials through final assembly of usable end items. Transportation is a major element since the material processing activities occur at various locations in the earth-space-moon environment. Both personnel and material must be transported between activity sites. Support encompasses all other activities necessary to accomplish the material processing and transportation activities.

Various facilities, equipment and resources are required to accomplish these necessary activities. For material processing, only those items which are used off the earth's surface will be considered in the LRU system. Costs of any earth-based material processing activities will be included and treated in the normal manner used for earth-based concepts. The transportation activity will require

conventional rockets and other devices such as the mass driver/mass catcher. Transportation introduces a need for propellant, which can be a significant and costly resource requirement. The fact that personnel will be located at most space and lunar activity locations generates a requirement for habitats. Other supporting elements include such things as power systems and propellant depots. These system elements are interrelated, and in defining a particular LRU concept they must be properly sized to ensure a smooth flow of activity.

There are many possible LRU system concept options. These can generally be categorized by where specific activities take place and the degree of lunar material utilization. Three "generalized" LRU systems options have been defined as representative space based, lunar based, and combination space/lunar based operating scenarios. Each of these scenarios will be iterated via the earth material requirements analysis procedure to test various options within each systems concept, and develop one or more "best" concept(s) for each operating scenario.

Table 4-1 compares the earth-based approach (Option A) with these three generalized LRU system concept options:

Table 4-1. Summary of material processing locations for the Earth Baseline and three generalized space manufacturing options.

End Product	Location Where Function is Performed									
	Mining	Benefi- ciation	Smelting	Refining	Forming	Processing	Component Manufacture	Initial Assembly	Final Assembly	
OPTION A Earth Based	Propellants Earth Launch System Earth Satellite Mat'l Earth	Earth	Earth	-	Earth	-	Earth	-	-	-
			←						→	Earth GEO
OPTION B Space Based	Propellants O ₂ Lunar Launch System Earth Satellite Mat'l Lunar	SMF	-	SMF	-	SMF	-	-	-	-
		←							→	Earth SMF
OPTION C Lunar Based (LH ₂ from Earth)	Propellants O ₂ Lunar Launch System Earth Satellite Mat'l Lunar	O ₂ Lunar	-	O ₂ Lunar	-	O ₂ Lunar	-	-	-	-
		←							→	Earth GEO
OPTION D Lunar Based (All Lunar Prop)	Propellants Lunar Launch System Lunar Satellite Mat'l Lunar	Lunar	-	Lunar	-	Lunar	-	-	-	-
		←							→	Lunar GEO
			←						→	Lunar GEO

OPTION A. EARTH BASELINE TRANSPORTATION REQUIREMENTS

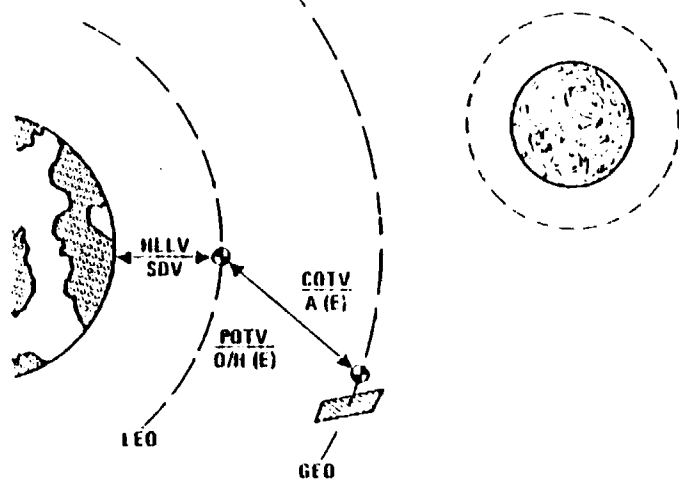

OPTION B. SPACE BASED TRANSPORTATION REQTS

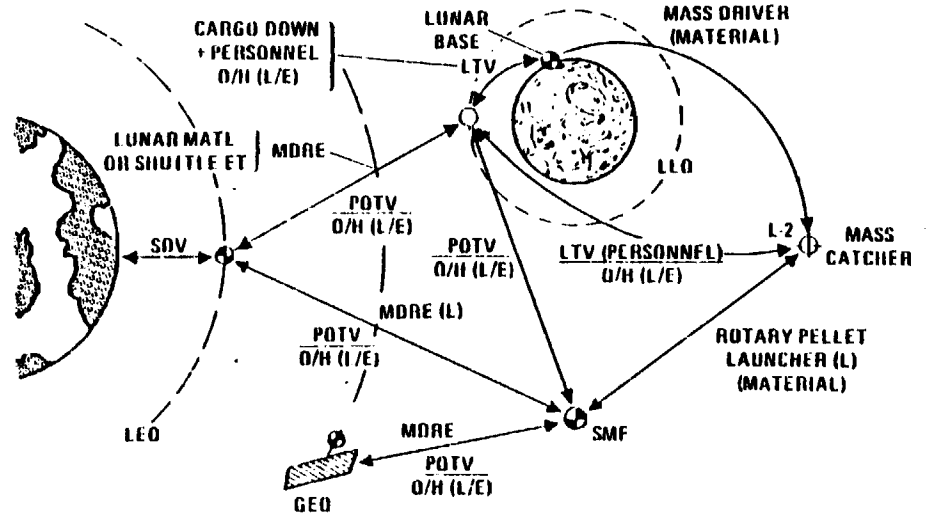

OPTION C. LUNAR BASED TRANSPORTATION REQTS

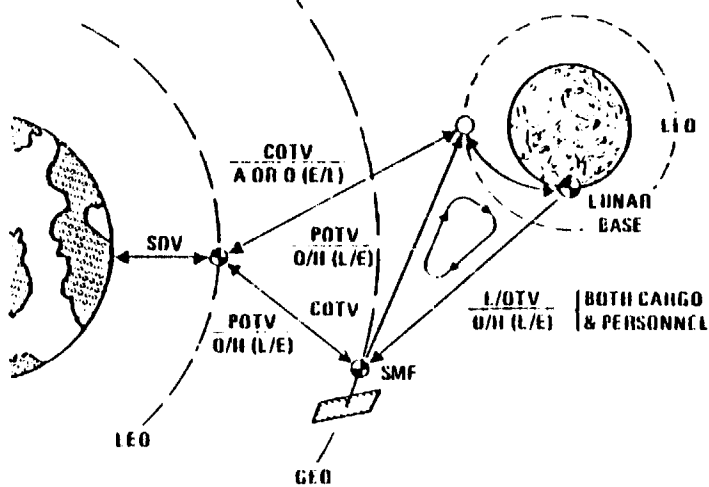

OPTION D. LUNAR / SPACE BASED TRANSPORTATION REQTS

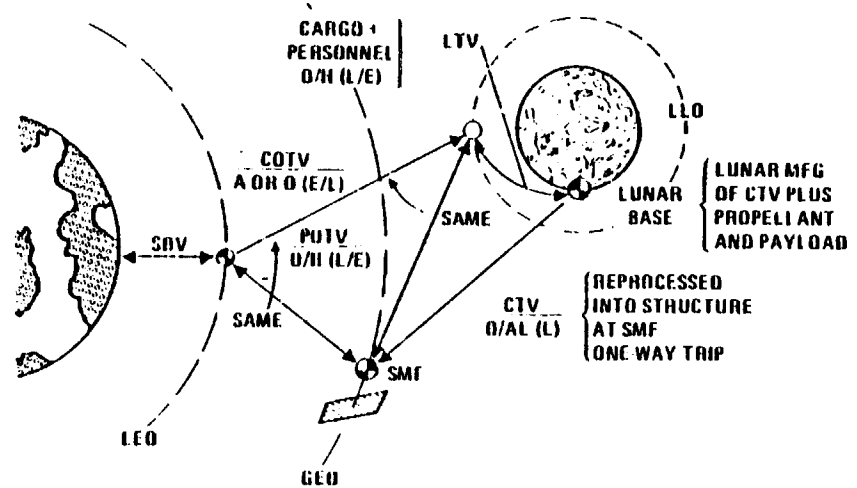

SYMBOLS

- SPACE STATION/HABITAT
- LARGE SPACE STRUCTURE

- COTV - TRANSPORTATION VEHICLE TYPE
- O/H (E) - ORIGIN OF PROPELLANTS (E) EARTH (L) LUNAR
- (L) - PROPELLANTS O - OXYGEN H - HYDROGEN A - ARGON

- PROPELLANT DEPOT (UNMANNED)

Figure 4-1. Four representative implementation options for in-space manufacturing of large structures.

- Earth based (NASA-JSC SPS as defined in "A Recommended Preliminary Baseline Concept Satellite Power System Concept Evaluation Program", January 25, 1978.
- Space based (space manufacturing concept developed through three NASA-Ames sponsored Summer Studies).
- Lunar based (a representative concept employing lunar manufacturing).
- Lunar/space based (a representative concept combining lunar and space manufacturing).

Option A - Earth Based - The earth material utilization scenario, shown in Figure 4-1, is based on techniques developed and perfected during NASA's past space accomplishments but implemented on a much larger scale. Two earth-to-LEO launch vehicles are employed: a fully reusable heavy lift launch vehicle (HLLV) for cargo, and a shuttle derived personnel launch vehicle (PLV). The HLLV is a two-stage fly-back vehicle with chemical propulsion and 424-ton payload capability. Its payload consists of crew support stations, fabrication machinery, assembly jigs, orbital transfer vehicles (OTV), and all construction supplies and OTV propellants. The PLV replaces the Shuttle's tandem burn solid rocket boosters with a series-burn O₂/methane ballistic entry first stage, and has an Orbiter modified to carry 75 passengers with their personal equipment.

Large structural sections are fabricated, inspected and checked out in LEO. These completed satellite sections are transferred to their operational location with unmanned cargo orbital transfer vehicles (COTV). The COTV uses a low-thrust/high-impulse solar powered electric propulsion system and argon propellant. Final assembly of these satellite sections into the complete large space structure is performed at its operational locale, typically GEO. Manned transfer from LEO to GEO is provided by a high-thrust two-stage chemical personnel orbital transfer vehicle (POTV).

Option B - Space Based - The lunar material utilization scenario developed for space manufacturing and space settlements includes unique elements and innovative techniques, and represents the proposals of Dr. Gerard O'Neill of Princeton University. Material brought from earth includes transportation elements and

their propellants, lunar mining equipment, material processing and fabrication equipment, personnel plus their habitats and supplies, and a small percentage of large space structure components which cannot initially be manufactured economically in space.

Transfer of these payloads and personnel from earth to LEO is accomplished by Shuttle-derived vehicle (SDV). A relatively small logistics station is constructed of Shuttle external tanks in LEO. This facility is used as a base to assemble transportation, processing, and habitation elements, and to integrate payloads for departure to their operational locales. All personnel transfer to other orbits is accomplished with a high thrust chemical POTV.

Cargo transfer is provided via a low-thrust solar-powered linear electromagnetic accelerator called a mass driver reaction engine (MDRE). This vehicle produces thrust by exhausting any available waste mass (ground-up external tanks or lunar slag) at very high velocity (8,000 m/s). The MDRE delivers lunar base material plus the lunar transfer vehicle (LTV) and its propellants to low lunar orbit (LLO), the mass catcher to L_2 , and space manufacturing facility/habitation modules to their selected locale.

The lunar base is established by using the throttlable chemical LTV to land material and personnel. The lunar base consists of mining equipment, a fixed mass driver catapult to launch lunar material to L_2 , living accommodations for personnel, a power plant (solar or nuclear), and supplies. Lunar surface operations include material collection, screening, bagging and launch by the mass driver in a steady stream toward L_2 . This material is retrieved by the mass catcher at L_2 , accumulated in large loads, and subsequently delivered to the space manufacturing facility (SMF), by rotary pellet launcher and terminal tug. At the SMF, this lunar soil is processed into useful structural materials, fabricated into components, and final-assembled into the large space structure.

Although most of these manufacturing operations are highly automated, a significant number of personnel are required for final assembly, machine operation, maintenance and repair, plus support services. Completed earth service satellites are transferred to their operating orbital location (typically GEO) by MDRE. This space manufacturing concept is amenable to bootstrapping, a technique by which a relatively modest initial lunar material throughput can provide products which are then directly applied to increasing the original manufacturing facility's production capability. Thus, sustained bootstrapping can simultaneously provide increased production capability and products. Unfortunately, due to this study's goal of determining a material requirements threshold point, we will be unable to take advantage of bootstrapping. This occurs because the bootstrapping concept results in a steadily increasing production capability and manufacturing rate, so comparison with constant rate manufacturing operations is extremely difficult.

Option C - Lunar Based - This option constitutes a significant departure from the Option B concept in two primary areas: material processing occurs on the lunar surface rather than in-space, and conventional rockets replace the mass driver catapult, mass catcher, and MDRE. Option C has some transportation and support elements that are very similar to those in Option B, such as earth launch and LEO station requirements. OTVs differ from those in B only by the design of cargo transfer stages and their propellant needs (type and quantity).

The COTV is an electric propulsion stage which can use either earth-supplied argon propellant when outbound or lunar-supplied oxygen propellant when inbound. The lunar base is significantly larger since it now provides material processing and component manufacturing in addition to mining and beneficiation.

A chemical lunar/orbital transfer vehicle (L/OTV) is used to transport finished construction supplies to the space manufacturing facility. The L/OTV propellants are lunar derived oxygen and earth-supplied hydrogen. This vehicle normally makes a round trip from lunar base to SMF to LLO and back to the lunar base. It also supplies oxygen to a propellant depot in LLO for the COTV. Large

space structure fabrication and final assembly are accomplished at the SMF which may be coincident to its product's use location.

Option D - Lunar/Space Based - The approach taken by the lunar/space-based option reduces earth propellant requirements. This is accomplished by obtaining both fuel and oxidizer from lunar materials, and is identical to Option C except for the lunar base, SMF, and the transportation between them. To reduce propellant requirements the cargo transfer vehicle (CTV), which transports finished components from lunar base to SMF, is configured as an expendable vehicle. This can only be competitive if the CTV tankage is manufactured at the lunar base from lunar material (aluminum), and reprocessed at the SMF into large space structure components. Therefore, some manufacturing operations are duplicated at these two locations, but the majority of lunar material processing remains at the lunar base. The lunar base must be expanded to include propellant tank fabrication and CTV assembly, checkout, and launch. CTV propulsion (engine) and avionics modules are earth-manufactured subsystems which are recycled from SMF to lunar base for reuse. The return of these subsystems is accomplished by chemical OTVs and LTVs which also perform all personnel transfer.

These three Lunar Resources Utilization options are presented only as representative techniques encompassing a wide range of space manufacturing scenarios. The earth material requirements analysis technique was employed to determine effects of various options on each of these generalized LRU scenarios. Variable input parameters included lunar material utilization percentage, alternative propellants and propellant sources, different transportation element designs, and efficiencies of material processing, manpower utilization and so forth. Results of this analysis, and the LRU systems concepts developed by this iterative process are described in Section 4.2, which follows.

4.2 EARTH MATERIAL REQUIREMENTS (EMR) & LRU CONCEPTS DEVELOPMENT

The earth material requirements are determined via development of material logistics scenarios for each candidate LRU option. Material logistics scenarios involve the integration of lunar material processing, infrastructure support facilities, and transportation elements to provide systems delivery definition of the required construction material when, where, and at the rate needed. A steady-state material logistics scenario assumes that all necessary facilities, vehicles, and personnel are in place and working. It defines the constant material flow rates needed to sustain the system's nonfluctuating output. This scenario is used to compare and better understand alternative LRU concepts.

Constructing satellite power systems (SPS) from lunar material is extremely complex. A kilogram of aluminum structure produced at an SMF depends on a many tiered pyramid of supporting activities for its creation. The aluminum ore obtained from the moon must be processed using chemicals from earth, a small percentage of which are lost in recovery. Alloying elements may be needed from earth in addition to personnel, supplies and machinery replacement parts. Transportation of earth supplies to the moon or SMF, and lunar material transfer to SMF, both require propellants which must be obtained, and transported from, these same sources.

These and other effects can all be traced back to determine total earth material requirements per unit of SPS. Comparison of the total earth material requirements (EMR) for alternative LRU concepts provides a direct top level evaluation method useful in preliminary screening of concepts. For example, a viable LRU concept would require a substantially lower EMR than the earth material construction baseline to ever reach the total life-cycle cost crossover. By this technique, some noncompetitive concept suboptions can probably be screened out on the basis of EMR without proceeding through subsequent economic analyses.

Each generalized LRU systems concept has been analyzed to assess transportation system options and determine sensitivities to various performance and operational parameters. As this analysis was performed, it became obvious that some of our initially defined system concepts described in Section 4.1 (shown in Figure 4-1), were relatively inefficient from an EMR standpoint, and that alternative techniques provided significantly improved system performance. These revised concepts are defined at the beginning of each subsequent subsection, followed by summarized EMR and lunar material requirements (LMR) data for the revised concept at the recommended 89.6 percent LRU level for SPS manufacture. This is followed by results of sensitivity studies and evaluation of the options considered within each systems concept.

Determination of earth and lunar material requirements is highly dependent on vehicle propellant requirements and transportation efficiency. Data sheets defining the various vehicles used to support these EMR analyses are contained in Section 4.6. Likewise, definition of processing/manufacturing elements and infrastructure elements are contained in Sections 4.4 and 4.5, respectively.

Previous scenario development accomplished during proposal preparation, and employed as an example on page 2-18 (Comparison Methodology and Criteria, Task 5.1), was updated and refined to reflect improved understanding of transportation system and other concept elements. The computer program used for this analysis has been revised to allow variation of input parameters in order to accomplish sensitivity studies. Earth and lunar material requirements are plotted as a function of the Lunar Resource Utilization percentage for SPS construction, to demonstrate steady state EMR and LMR sensitivity to LRU percentages other than 89.6 percent.

A common set of assumptions and performance criteria were used for developing

EMR and LMR for the earth baseline and lunar resource utilization concepts.

These are itemized below:

- 1) Steady-state operations - start-up phase complete and all earth, lunar and space facilities in place.
- 2) All hydrogen propellants are delivered from earth.
- 3) For LRU options, all other propellants used above LEO are obtained from the moon.
- 4) Processing of lunar soil results in 33% oxygen recovery. (10 kg soil yields 3.3 kg O₂)
- 5) Chemicals expended (lost) in lunar processing equal 0.5% of soil processed.
- 6) Ecosystems are partially closed. Crew requirements including food and water from earth are 0.8 ton/year/person.
- 7) Crew size requirements were obtained from the following formulas:

For all options except B:

$$\text{GEO crew} = 200 (\text{SPS quantity/year})$$

For options C and D:

$$\text{Lunar base crew} = 200 + 1300 (\text{SPS/yr})(\text{lunar material fraction})$$

For option B:

$$\text{Lunar base crew} = 30 + 20 (\text{SPS/yr})(\text{lunar material fraction})$$

For option B:

$$\text{SMF crew} = 200 + 1300 (\text{SPS/yr})(\text{lunar material fraction})$$

For option B:

$$\text{GEO crew} = 36 (\text{SPS/yr}) \text{ for maintenance only}$$

- 8) Crew transport requirements are based on return to earth after the following duty tours:

For option A: 90 days at LEO or GEO

For options B, C, and D: 60 days at GEO

180 days at SMF

180 days at lunar base

- 9) Transportation vehicle performance parameters are listed in Table 4-2.

Table 4-2. Definition of Vehicle Performance Assumptions.

VEHICLE	ROUTE	ΔV (m/sec)	STAGE EFFICIENCY (kg prop/kg PL)	ASSUMPTION
HLLV	Earth - LEO	9,450	21.7	Round trip empty return
SDV	Earth - LEO	9,450	17.2	Round trip
SS	Earth - LEO	9,450	57.5	Round trip
COTV (O ₂) (Electric)	LEO - GEO	11,660	0.245	Round trip empty return
	LEO - LLO	16,640	0.3168	One way
	LLO - GEO	4,700	0.0799	Round trip empty return
	LEO - SMF	15,519	0.2912	One way
	SMF - GEO	3,890	0.06	Round trip empty return
MDRE (O ₂) (Electric)	LEO - GEO	5,820	1.23	Round trip empty return
	LEO - LLO	8,300	2.31	One way
	LEO - SMF	7,760	2.05	One way
	SMF - GEO	1,945	0.285	Round trip empty return
LTV (O ₂ /H ₂) (LDR)	Moon - LLO	1,860	0.6715	Round trip with 10% payload down
	Moon - LLO	1,860	1.835	Round trip with 10% payload down
PLTV (O ₂ /H ₂)	LLO - Moon	1,860	1.52	Round trip with 100% payload up
POTV (O ₂ /H ₂)	LEO - GEO	4,330	2.2	One way
	LEO - LLO	3,960	1.87	One way
	LEO - SMF	4,130	2.1	One way
Mass catcher	~ L ₂	230	N/A (Slag)	Round trip empty return
TT (O ₂ /H ₂)	~ SMF	100	0.0248	Round trip empty outbound

	COTV (O ₂)	LTV (O ₂ /H ₂)	LDR (O ₂ /Al)	PLTV (O ₂ /H ₂)	POTV (O ₂ /H ₂)	TT (O ₂ /H ₂)
Mass fraction (W _p /W _{stage})	0.35-0.67*	0.89	0.90	0.89	0.90	0.89
Mixture ratio (O/F)	N/A	7:1	2.22:1	7:1	7:1	7:1
Specific impulse (N-s/kg)	68,600	4,508	2,500	4,508	4,508	4,508

*Dependent on transfer leg

- 10) Ion electric COTV and MDRE vehicles require LH_2/LO_2 attitude control propellants to maintain vehicle pointing during occulted periods. ACS propellant requirements for LRU option COTV's and MDRE's were assumed to be 25% of that for Concept A COTV delivery of SPS segments, appropriately adjusted to transfer leg ΔV requirements. These reduced COTV ACS propellant requirements are justified by improved payload densities for LRU options and/or reduced gravity gradient torques on many transportation routes.
- 11) For Concept B, lunar material packaging is required for mass driver catapult launch. It was assumed that these packages were manufactured from lunar derived woven fiberglass, with a mass 0.02 times the material quantity to be catapulted.

Differential velocity (ΔV) requirements data in Table 4-2 shows a significant difference for ion electric COTV's and MDRE's on the same transportation route. MDRE ΔV 's are based on point mass transfer requirements (Ref 1), while COTV values have been obtained from work on the Earth Baseline (Concept A) for transfer of large area SPS segments by the Boeing Company (Ref. 2). Some of this Concept A ΔV is probably due to steering and attitude control losses associated with the unwieldy SPS payload geometry, but the difference for COTV's transporting high density bulk cargo is indeterminate based on Concept A data. For consistency with the Concept A EMR, scaled ΔV 's consistent with the Earth Baseline values were used for all LRU options, rather than point mass ΔV 's. MDRE performance at these higher ΔV requirements is unacceptable so point mass values have been retained for MDRE analysis. This resulted in very optimistic assessment of MDRE when compared with the ion electric COTV. Reference 1 is included as Appendix E, Section E.1 in Volume III.

The initial EMR subsection defines the earth baseline material requirements, and following subsections sequentially address LRU system Concepts B, C and D, which have been updated based on EMR analysis results.

4.2.1 Concept A - Earth Baseline

Concept A is the totally earth supplied comparison baseline. Its definition has been obtained from the NASA-JSC "Satellite Power System (SPS) Concept Evaluation Program - A Recommended Preliminary Baseline Concept," dated 25 January 1978. In this scenario, earth materials are launched into low earth orbit (LEO) where they are assembled into SPS segments at the LEO base. Each SPS will consist of eight segments, two with microwave antennas and six without. After construction, these segments will be transferred from LEO to geosynchronous earth orbit (GEO) by argon propellant ion thrusters powered by partially deployed photovoltaic arrays on the SPS segments. The eight segments are assembled into a complete 10 GW SPS at the GEO base. No revisions to the option described in Section 4.1 have been made, since Concept A is the representative NASA Earth Baseline.

Figure 4-2 shows a material flow diagram for Concept A. It shows 354 earth material units required for each 10 units of SPS completed in GEO. The vast majority of these, 331 units, are in the form of HLLV propellants. Total earth payload is 15.1 units plus personnel. All crew size estimates are based on the manufacture of one 10 GW SPS per year.

The Figure 4-2 material requirement identified as "COTV" refer to the ion thrusters used for LEO to GEO transfer of SPS segments. These ion thrusters comprise an expendable delivery method, and since they are not reused, the thrusters and their propellant tankage contribute to steady state earth material requirements.

The steady state life support requirements for the earth baseline are obviously insignificant (only 0.3% of earth launched payload) but have been included for later comparison with LRU concepts. Life support requirement insignificance for Concept A is important since for all lunar resource utilization options, life support needs will increase, while most other earth launched material requirements (except hydrogen) will decrease. The net effect of this will be a substantially lower EMR, as demonstrated by the following LRU systems concepts.

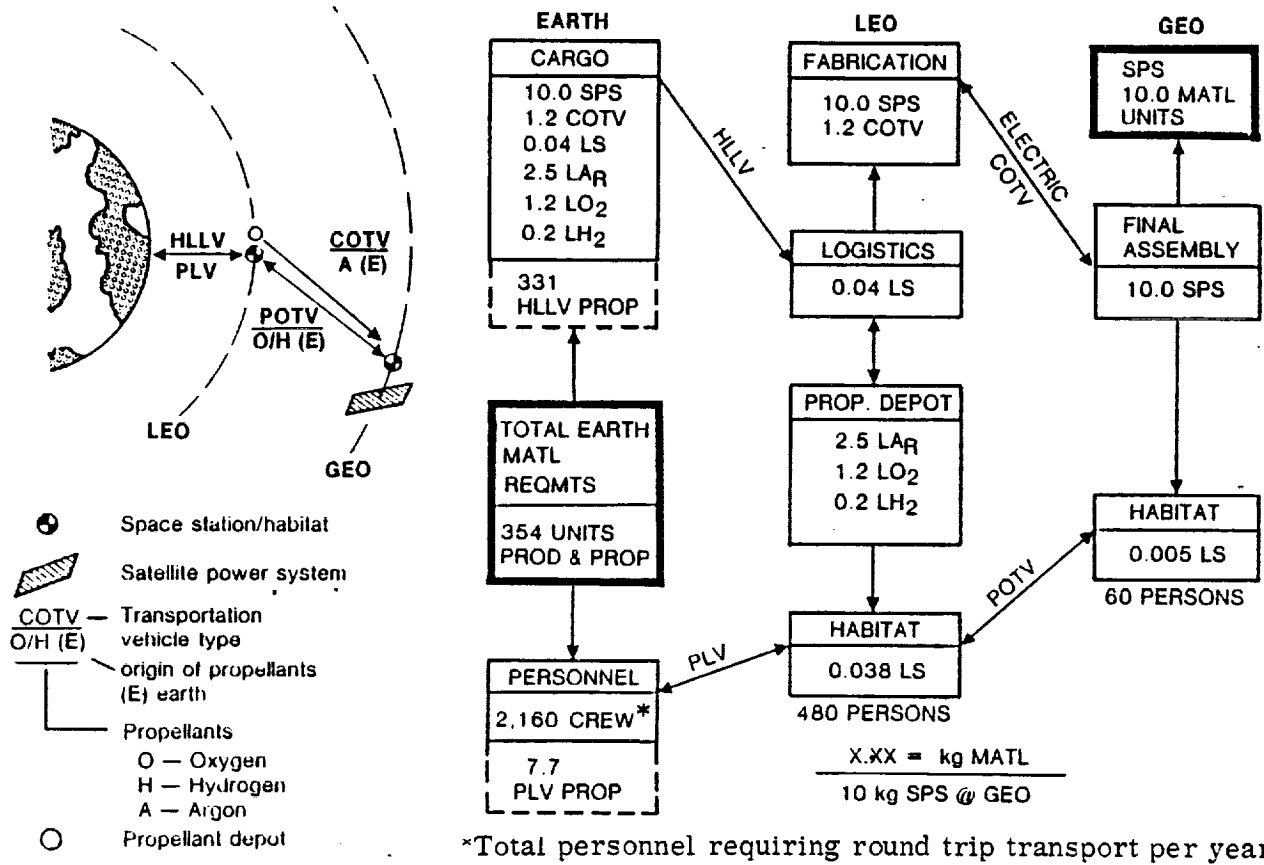

Figure 4-2. Concept A — Earth Baseline SPS.

4.2.2 Concept B - Lunar Mass Driver Catapult

This systems concept is characterized by the mass driver catapult/catcher for lunar material transport, and lunar material processing at the space manufacturing facility. Concept B is considered the most technologically advanced of the LRU system concepts. Due to its innovative features, it exhibits considerable technical risk but also offers significant potential benefits. Figures 4-3 and 4-4 show the logistics flow diagram and requirements for the revised version of systems Concept B. Figure 4-4 illustrates the transportation logistics flow of all materials including payload, propellants, life support (LS) consumables, and lunar material processing chemicals during the steady-state manufacturing phase of operations for LRU at the 89.6 percent level. Crew requirements reflect an SPS production rate of one 10 GW satellite annually.

Analysis of the original option B scenario as described in Section 4.1 resulted in one significant revision: the mass driver reaction engine (MDRE) was replaced by an ion-electric COTV employing lunar oxygen as propellant. This change was

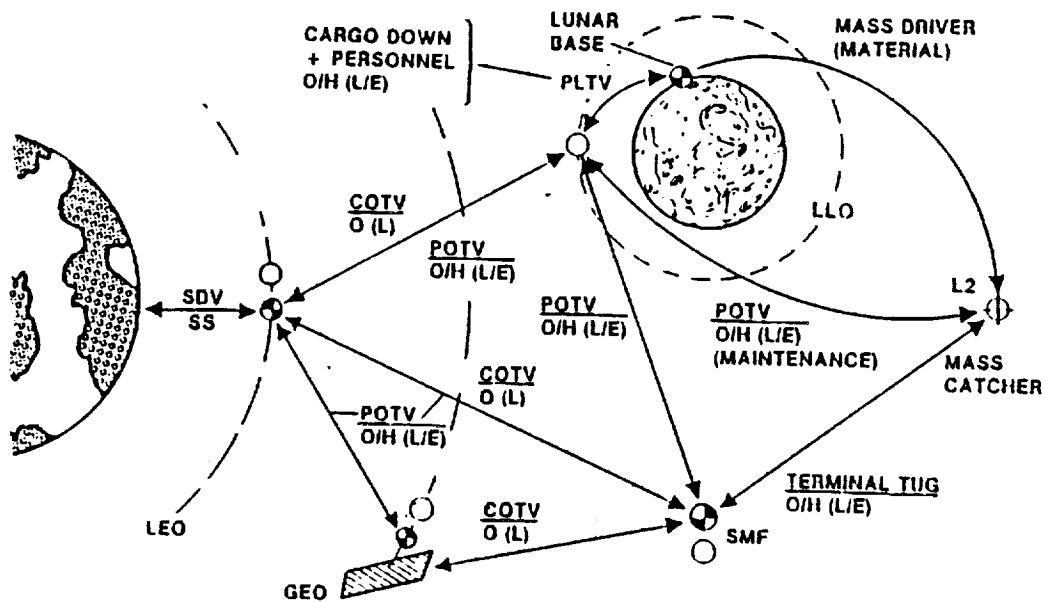

Figure 4-3. LRU Concept B - Lunar Mass Driver Catapult.

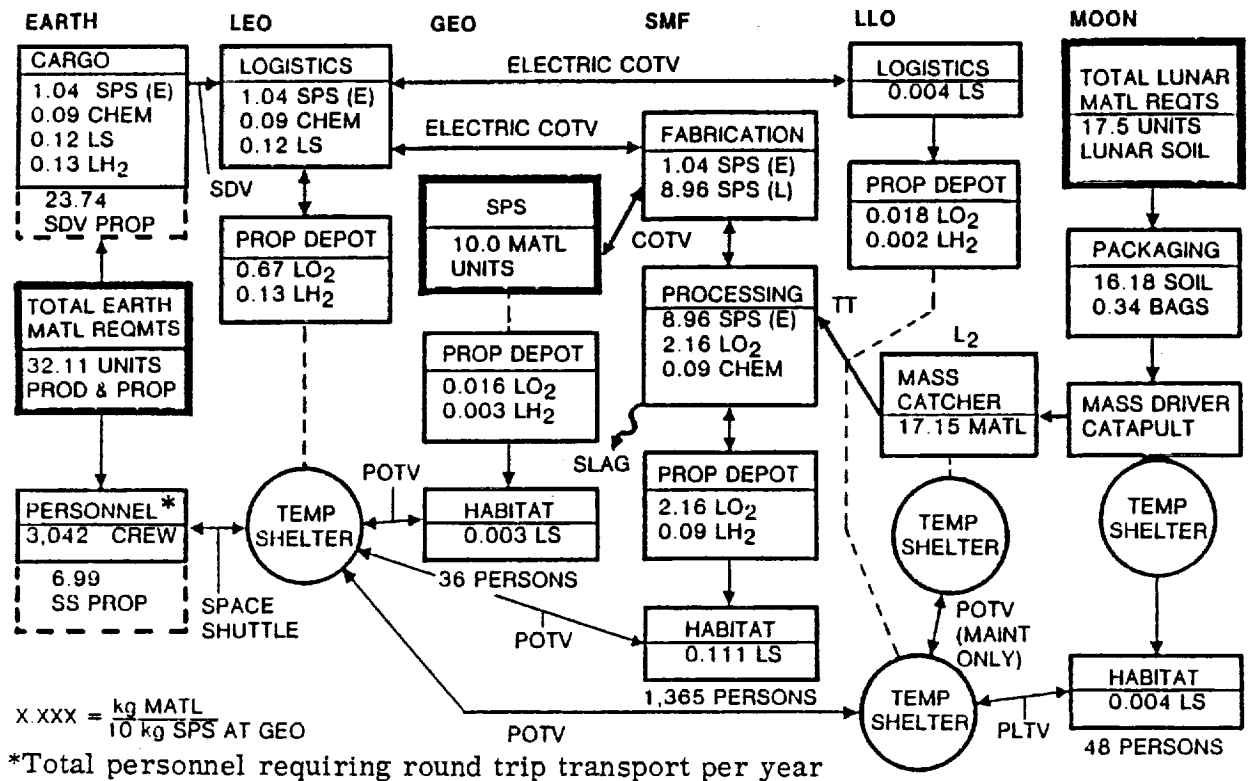

Figure 4-4. LRU Concept B - Mass Driver Catapult.

made necessary by poor MDRE performance when using transfer ΔV 's consistent with option A values. Even if theoretical ΔV 's are employed for the MDRE, the ion-electric COTV offers significant performance improvements due to its higher specific impulse and reduced propellant requirements.

Specifically this COTV replacement is recommended because:

- 1) The COTV specific impulse is approximately 6 times greater than that for the MDRE.
- 2) A lunar derived propellant, oxygen, is acceptable for use with an ion-electric COTV. This reduces somewhat the MDRE advantage of using any available waste material as reaction mass.
- 3) Study personnel feel strongly that if the MDRE were used, it should employ a material such as oxygen for reaction mass. This will eliminate the safety concern of solid high velocity exhaust particles in the vicinity of habitats, manufacturing facilities, and SPS's. Thus similar lunar propellant processing

requirements would be imposed for MDRE or ion electric COTV, since both use oxygen propellant.

Figure 4-4 shows that only 32.11 total earth material units, consisting of 1.38 units of payload plus SDV propellant must be launched from earth to construct 10 units of SPS and deliver it to geosynchronous orbit. Since no lunar derived propellants are needed to transfer material from the lunar surface to L_2 , the lunar material requirements (LMR) are dominated by material requirements for SPS construction, rather than for transfer vehicle propellants.

Sensitivity results obtained from EMR are summarized in paragraph 4.2.5. Details of these sensitivity investigations are contained in Appendix B, Volume III of this Final Report.

4.2.3 Concept C - Lunar LH_2/LO_2 Chemical Rocket — This systems concept employs conventional LO_2/LH_2 rockets to transport SPS stock material manufactured at the lunar base into lunar orbit. Since all Concept C transportation routes are serviced by either O_2/H_2 chemical rockets or ion electric transfer vehicles, this systems concept exhibits low technical risk with respect to its transportation elements. The revised version of Concept C is shown in Figure 4-5,

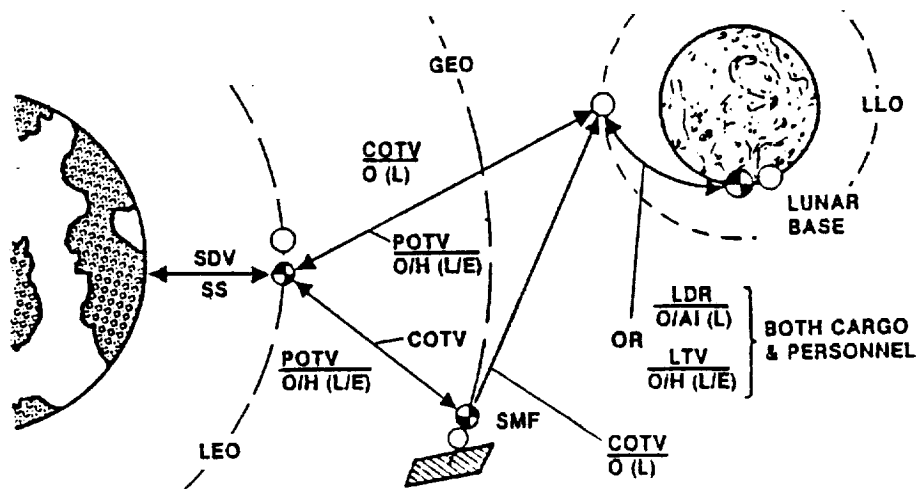

Figure 4-5. LRU Concepts C&D - Lunar Chemical Rockets.

and EMR results are defined in Figure 4-6 for the 89.6 percent LRU level. Crew requirements reflect support for the annual production of one 10 GW SPS.

Analysis of the original option C scenario as described in Section 4.1 has resulted in a revision to the transportation method for delivering lunar manufactured stock material to the GEO fabrication facility. Originally, a large conventional LH₂/LO₂ cargo transfer vehicle (CTV) was assumed for delivery of SPS components directly from the lunar surface to GEO. The revision depicted by Figures 4-5 and 4-6 has replaced this single large chemical rocket with two other vehicles:

- 1) A smaller LO₂/LH₂ LTV to deliver SPS components from the lunar surface to LLO.
- 2) An ion electric COTV using lunar derived oxygen propellant to deliver the components from LLO to GEO.

This revision provides a significant transportation performance improvement, and requires less earth supplied hydrogen and lunar supplied oxygen.

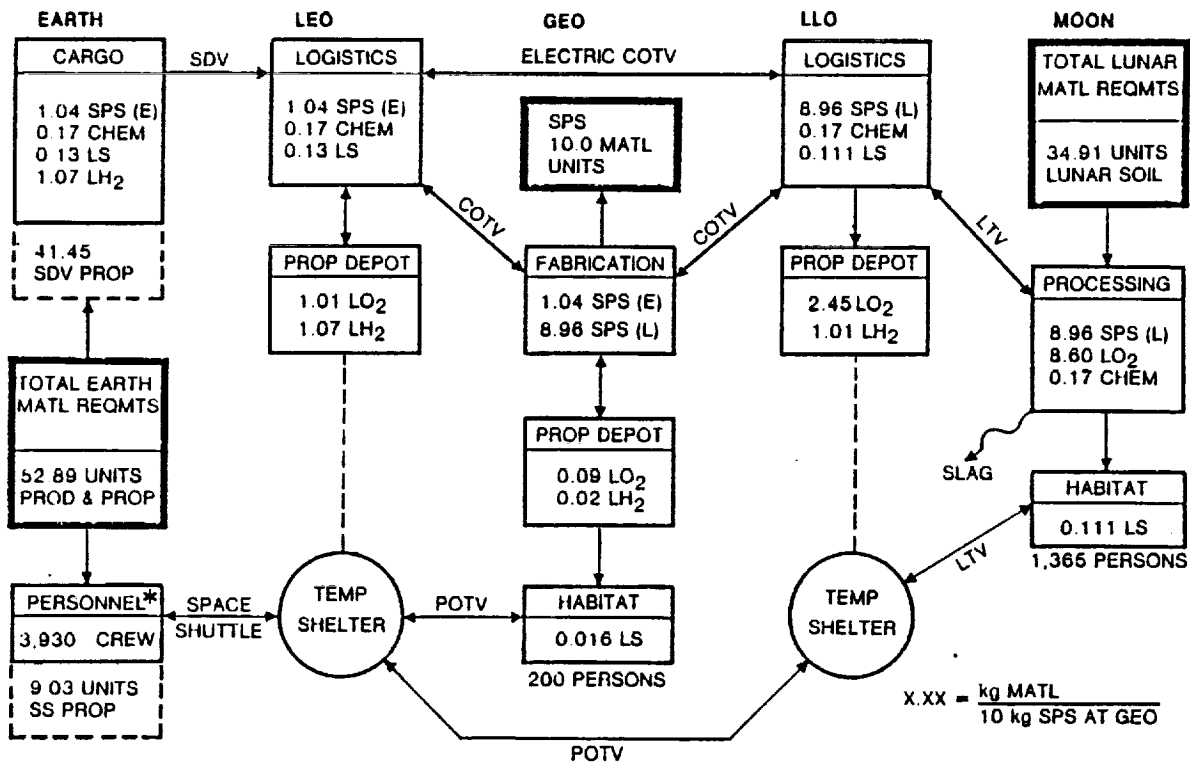

*Total personnel requiring round trip transport per year

Figure 4-6. LRU Concept C - LO₂/LH₂ Lunar Transfer Vehicle.

Figure 4-6 shows that 52.89 total earth material units, consisting of 2.41 units of payload plus SDV propellant must be launched from earth to construct 10 units of SPS and deliver it to geosynchronous orbit. EMR sensitivity results are discussed in 4.2.5 of this volume and Appendix B of Volume III.

The propellant requirements for the SDV and in-space transport vehicles (COTV's, POTV's and LTV) are the key drivers for EMR and LMR respectively. The total lunar material requirement is dependent on the total quantity of oxygen needed. Most of the lunar oxygen is used for delivery of SPS materials/components from the lunar surface to the SMF, which is assumed to be coincidentally located to the SPS final assembly and use location in GEO. Some lunar oxygen is recombined with silicon to provide high quality silica glass for SPS solar cell covers and substrate.

4.2.4 Concept D - Lunar Derived Rocket

Systems Concept D is similar to Concept C as shown in Figure 4-5, except for the vehicle used to transfer construction materials from the lunar surface to low lunar orbit. The LTV has been revised from the LH_2/LO_2 chemical rocket used in Concept C, to a chemical rocket which derives all its propellants (fuel and oxidizer) from lunar materials. This revision reduces considerably the quantity of hydrogen which must be supplied from earth. The baseline all lunar propellant LTV or lunar derived rocket (LDR) uses liquid oxygen as oxidizer and powdered aluminum as fuel. Alternative fuels include mixtures of lunar metals including aluminum, calcium, iron, magnesium, sodium and titanium.

The LDR originally assumed for SPS stock material delivery from the lunar surface to GEO assembly base was a large single stage expendable vehicle. This expendable vehicle is undesirable since extensive fabrication facilities are required at the lunar base to manufacture LDR propellant tanks, and reprocessing facilities are needed in GEO to convert LDR propellant tankage into SPS components. A reusable vehicle for lunar surface to GEO transport of cargo is a more desirable transportation solution.

Performance calculations, however, have shown that the lunar derived rocket (LDR) does not have enough specific impulse to make a round trip flight from lunar surface to GEO and back to the lunar base. Therefore, a revised Concept D baseline was developed by replacing the expendable LDR with two other reusable vehicles:

- 1) A smaller LDR to deliver SPS stock materials from the lunar surface to LLO.
- 2) An ion electric COTV using lunar derived oxygen propellant to deliver these components from LLO to GEO.

The employment of a reusable LDR reduces manufacturing operations on both the moon (LDR propellant tank construction) and at the GEO assembly facility (tank reprocessing into SPS components), as well as significantly reducing lunar propellant processing requirements. The steady state material flow and personnel requirements for constructing one 10 GW SPS per year is depicted in Figure 4-7 for the revised Concept D baseline. This shows that 37.06 total earth material units, consisting of 1.54 units

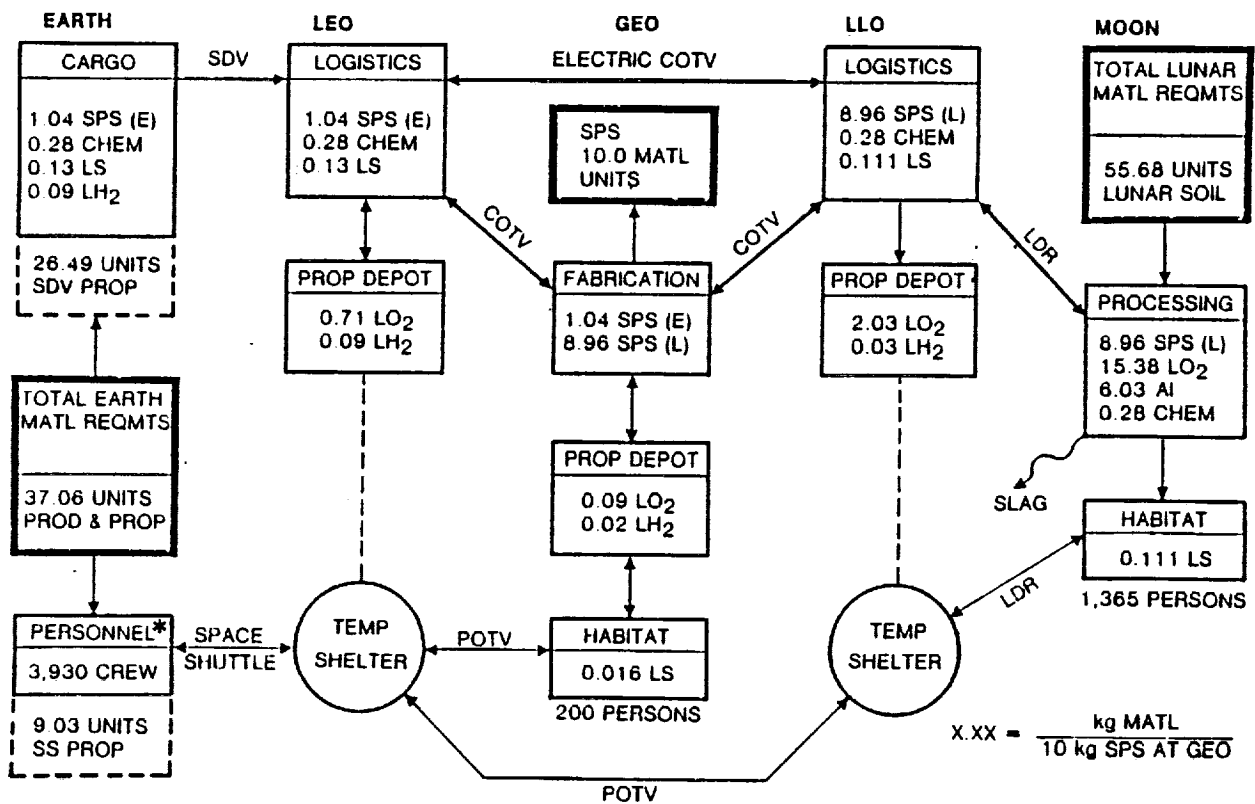

*Total personnel requiring round trip transport per year

Figure 4-7. LRU Concept D — Lunar Derived Rocket.

of payload plus SDV propellant must be launched from earth to construct 10 units of SPS and deliver it to geosynchronous orbit. EMR sensitivity results are discussed in 4.2.5 of this volume and Appendix B of Volume III. The total lunar material requirement for Concept D is dependent on the total quantity of aluminum needed, which nominally requires that ten times this amount of lunar soil must be processed. A sufficient quantity of all other required lunar derived materials are nominally contained within the soil processed for aluminum recovery.

4.2.5 EMR Sensitivity Analyses

Initial sensitivity information was obtained as part of the Lunar Resource Utilization Systems Concepts Definition, task. This data defined earth material requirements (EMR) and lunar material requirements (LMR) as a function of the lunar mass fraction used for SPS construction. The sensitivity of various vehicle designs, personnel support requirements, and processing chemical requirements received preliminary evaluation by use of this material sensitivity technique.

Material requirements as a function of lunar resource utilization percentage for the LRU system Concepts B, C and D are displayed in Figure 4-8. Earth material requirements (EMR) include all earth payload plus the earth launch vehicle propellant required to place this payload into LEO. Lunar material requirements (LMR) reflect the total lunar soil which must be mined to supply SPS material and transportation system propellants. The following paragraphs summarize the material requirements sensitivity to lunar resource utilization percentage used as an SPS construction material for each LRU concept.

Concept B — An interesting trend shown by this data is that both EMR and LMR decrease with increasing percentages of lunar material in the SPS. The primary reason for this is use of the solar or nuclear powered mass driver catapult (linear electromagnetic accelerator) which provides propellant free (but not power free) launch of material from

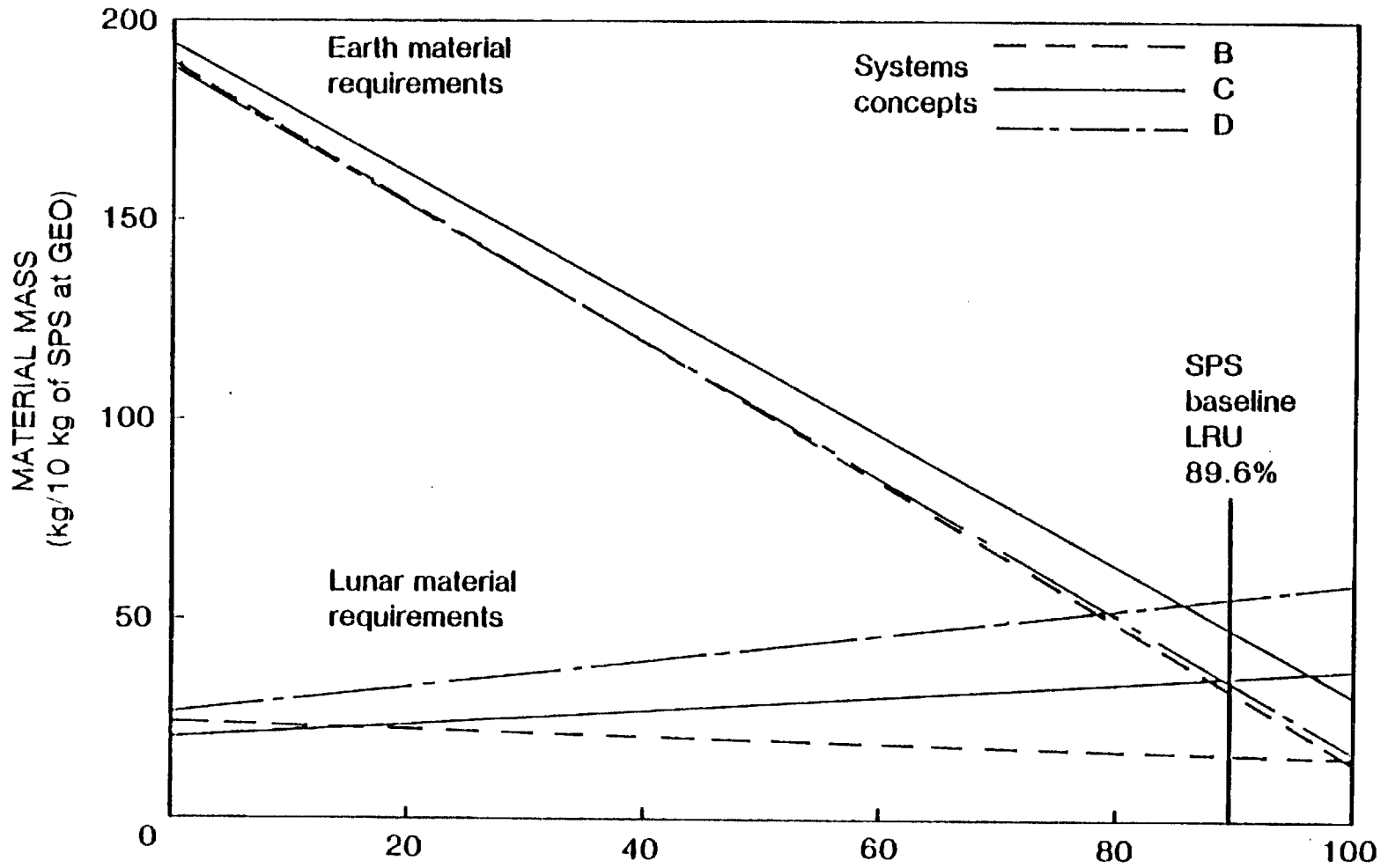

Figure 4-8. PERCENT OF SPS DERIVED FROM LUNAR RESOURCES

the moon's surface. The remaining primary LMR driver is the oxygen propellant required for cargo transfer from LEO to SMF. As the lunar material percentage increases, the quantity of oxygen propellant needed for transfer of earth materials decreases slightly. Both EMR and LMR for Concept B are lower at higher LRU percentages than those for Concepts C and D.

Concept C — The total earth material requirement is relatively high due to the large percentage of earth payload devoted to hydrogen propellant for the lunar transfer vehicle. The total lunar material requirement is dependent on the total quantity of oxygen needed, which nominally requires that three times this amount of lunar soil be processed. A sufficient quantity of all other lunar derived materials are contained within the soil processed for oxygen recovery. Most of the lunar oxygen is used for delivery of SPS materials/components from the lunar surface to LLO. These combined propellant requirements result in a positive LMR slope.

Concept D — The total lunar material requirement is dependent on the total quantity of aluminum needed, which nominally requires that ten times this amount of lunar soil must be processed. A sufficient quantity of all other lunar derived materials are nominally contained within the soil processed for aluminum recovery. Most of the lunar oxygen and aluminum is used as LDR propellant for delivery of SPS materials/components from the lunar surface to LLO. These combined propellant requirements result in a positive LMR slope.

For purposes of overall comparison, the SPS Earth Baseline EMR is off scale at a material mass of 331. The EMR for LRU options at zero resource utilization for SPS construction is significantly lower than this since lunar oxygen is employed for all transportation vehicles operating above LEO. This reduces the EMR by a factor of approximately 1.5. The remaining factor is due to the SDV's better stage efficiency (than HLLV) caused by its use of an expendable external tank.

In addition to basic EMR and LMR sensitivity to the percentage of lunar resource utilization in SPS construction, sensitivity data was obtained on COTV type (ion electric or MDRE), vehicle stage efficiencies, chemical loss fraction during processing, oxygen recovery from lunar soil, personnel support requirements, and others. Table 4-3 summarizes some of this sensitivity data. All sensitivity results shown are referenced to baseline LRU material requirements information at the 89.6 percent utilization level. Of particular interest are results for LRU percentage and personnel requirements sensitivity analyses:

- o EMR is sensitive to the percent of SPS derived from lunar resources. A 10 percent decrease in LRU results in EMR increases of 52, 34, and 49 percent for Concepts B, C, and D respectively.
- o EMR is relatively insensitive to crew size, with doubled personnel requirements resulting in EMR increases of 27 and 17 percent for Concepts B and C.

Additional sensitive information is contained in Appendix B of Volume III.

Table 4-3. Material Requirements Sensitivity.

	B	C	D
Δ% EMR with - 10% LRU	+ 52	+ 34	+ 49
Δ% LMR with - 10% LRU	+ 6	- 5	- 7
Δ% EMR with 4x Chemical Loss Fraction @ 89.6% LRU	+ 15	+ 17	+ 46
Δ% EMR with 2x Crew Size @ 89.6% LRU	+ 27	+ 17	N/A
Δ% EMR with 2x ion Electric COTV Stage Efficiency @ 89.6% LRU	N/A	+ 4	0
Δ% LMR with 1.2x Lunar Cargo Xfer Vehicle Efficiency @ 89.6% LRU	0	+ 8	+ 16

4.3 EMR COMPARISON AND PRELIMINARY CONCEPT ASSESSMENT

The three revised baseline Lunar Resource Utilization systems concepts defined in Section 4.2 were developed by assessing various options within each basic concept. This was done to determine the best method of constructing geosynchronous solar power satellites with the least amount of material and supplies obtained from earth. The results of this activity are the material flow diagrams for LRU Concepts B, C and D shown in Figures 4-4, 4-6 and 4-7, respectively.

When this comparison activity was originally planned, it was assumed that at least one of the three LRU concepts, even when optimized for minimum steady state EMR, could be eliminated due to its non-competitiveness with the others. This has not occurred. All three Concepts B, C and D offer substantial EMR reductions with EMR factors at 9%, 15% and 10% of Earth Baseline respectively. A comparison of the data derived from these three LRU concepts plus the Earth Baseline (Concept A) is contained in Tables 4-4 and 4-5. Material requirements are listed per kilogram of SPS instead of per 10 kg as done previously. The significance of these results is summarized for each of the LRU concepts in the following paragraphs.

Concept B - Mass Driver/Catcher Delivery of Lunar Material to a Space Manufacturing Facility — Offers the lowest earth and lunar material requirements. The earth launched cargo consists of only 0.138 kg/kg SPS, made up of 0.104 SPS components plus 0.034 of other supplies. The lunar material requirements are also low, since very little lunar derived propellant is consumed to transport lunar materials to the SMF (only LO_2 for the terminal tug). These very attractive material requirements are balanced by a relatively large number of in-space activity locations, and some technologically advanced system elements (mass driver catapult and mass catcher). Due to these more numerous and advanced system element requirements, Concept B's development cost will probably be higher than that for Concepts C and D.

Table 4-4. Comparison of LRU Concepts and Earth Baseline.

	SYSTEMS CONCEPT			
	A Earth baseline	B Mass driver	C Conven- tional rocket	D Lunar derived rocket
$\left(\frac{\text{kg of material}}{\text{kg of SPS at GEO}} \right)$				
Total earth matl reqmts	<u>35.4</u>	<u>3.211</u>	<u>5.289</u>	<u>3.706</u>
Earth launch propellants	33.9	3.073	5.048	3.552
Propellant for space use	0.4	0.013	0.107	0.009
Processing chemicals	—	0.009	0.017	0.028
Life support supplies	0.004	0.012	0.013	0.013
SPS components & material	1.12	0.104	0.104	0.104
Total lunar matl reqmts	—	<u>1.715</u>	<u>3.491</u>	<u>5.568</u>
SPS components & material	—	0.896	0.896	0.896
Propellants	—	0.216	0.860	2.141
Slag	—	0.603	1.735	2.531
Total crew annual transport reqmts (persons)	2160	3042	3930	3930
Personnel @ LEO x tours per yr	480 x 4	—	—	—
Personnel @ GEO x tours per yr	60 x 4	36 x 6	200 x 6	200 x 6
Personnel on Moon x tours per yr	—	48 x 2	1365 x 2	1365 x 2
Personnel @ SMF x tours per yr	—	1365 x 2	—	—
Space & Lunar activity locations	2	6	4	4

Table 4-5. Summary LRU Concept Comparison With Earth Baseline.

	SYSTEMS CONCEPT			
	A Earth Baseline	B Mass Driver	C Conven- tional Rocket	D Lunar Derived Rocket
$\left(\frac{\text{kg OF MATERIAL}}{\text{kg OF SPS @ GEO}} \right)$				
Total Earth Material Requirements	<u>35.4</u>	<u>3.211</u>	<u>5.289</u>	<u>3.706</u>
Total Payload	1.52	0.138	0.241	0.154
Earth Launch Propellants	33.9	3.073	5.048	3.552
Total Lunar Material Requirements	—	<u>1.715</u>	<u>3.491</u>	<u>5.568</u>
Products	—	1.112	1.756	3.037
Slag	—	0.603	1.735	2.531
Total Crew Transport Requirements (people per year)	2160	3042	3930	3930

Concept C - Lunar Processing With Stock Delivery Via Conventional Rockets to GEO for Manufacturing and Assembly - has the highest earth material requirements and intermediate lunar material requirements. The earth launched cargo consists of 0.241 kg/kg SPS, made up of 0.104 SPS components plus 0.137 of other supplies. The majority of these other supplies are hydrogen propellants required for the chemical lunar transfer vehicle (LTV) employed to deliver lunar manufactured stock materials to space. The LTV derives its oxygen propellant from lunar materials, which is the major contributor to increased lunar processing and mining requirements. Concept C system elements are based on existing technology and many are scaled up versions of previous space vehicles which results in low technical risk, which when combined with the relatively low number of in-space activity locations, should result in the lowest LRU system development cost.

Concept D - Lunar Processing With Stock Delivery Via a Vehicle With Lunar Derived Propellants - has intermediate earth material requirements and the highest lunar material requirements. The earth launched cargo consists of 0.154 kg/kg SPS, made up of 0.104 SPS components plus 0.050 of other supplies. A majority of these other supplies are processing chemicals needed to produce the large quantity of lunar propellants required for the lunar derived rocket (LDR). The LDR uses liquid oxygen and powdered aluminum obtained from the moon as its propellants. The combined requirement for these elements is the driver for Concept D's very large lunar material mining and processing requirements. Concept D system elements are relatively conventional and comparable to those in Concept C, with the exception of the LDR. The LDR represents a new unproven chemical propulsion concept with associated development costs.

Since the steady state earth material requirements for these three LRU concepts are relatively close (compared to the Earth Baseline), and material requirements differences may be generally compensated for by development costs, we recommend that all three concepts be carried through the initial costing cycle and threshold determination analysis.

4.4 LUNAR MATERIALS PROCESSING AND MANUFACTURING

The flow diagram of Figure 4-9 identifies the lunar material flow, processing steps and manufacturing steps required to transform raw lunar material into a completed 10 GW solar power satellite.

The basic lunar derived materials required for the construction of the satellite and transport of materials and components to various locations include native lunar glass, oxygen, silicon, aluminum and iron, the latter two in pure and alloyed forms.

Lunar soil is beneficiated to recover free iron and glass fractions. The remainder is processed by electrolytic and/or chemical means to extract oxygen, silica and metals. The silica is further processed into clear silica glass sheet for solar cell substrates and covers. Silicon is purified to semiconductor grade material and grown into ribbons for fabrication into silicon solar cells. Aluminum and iron are processed by electron beam vapor deposition, casting, and other means into sheet, wire and other required stock forms and then fabricated into shapes and components required for the construction of the solar power satellite. The native lunar glass is combined with sodium sulfate and carbon from earth to manufacture foamed glass components.

The processes and principal facilities, required quantities, and forms of lunar derived materials have been identified for every stage of the production sequence. Facility mass and power estimates for the basic manufacturing equipment (electron beam vapor deposition guns, casting machines, furnaces, etc.) have been based on data for similar earth production equipment. For in-space or lunar surface use the mass and perhaps power consumption associated with these facilities can be reduced considerably. However, a significant quantity of peripheral equipment and tooling is required to support each major manufacturing function. Application of the full earth mass to similar facilities designed for in space use should adequately account for these undefined peripherals. The components identified in Figure 4-9 correspond to the 89.6 percent

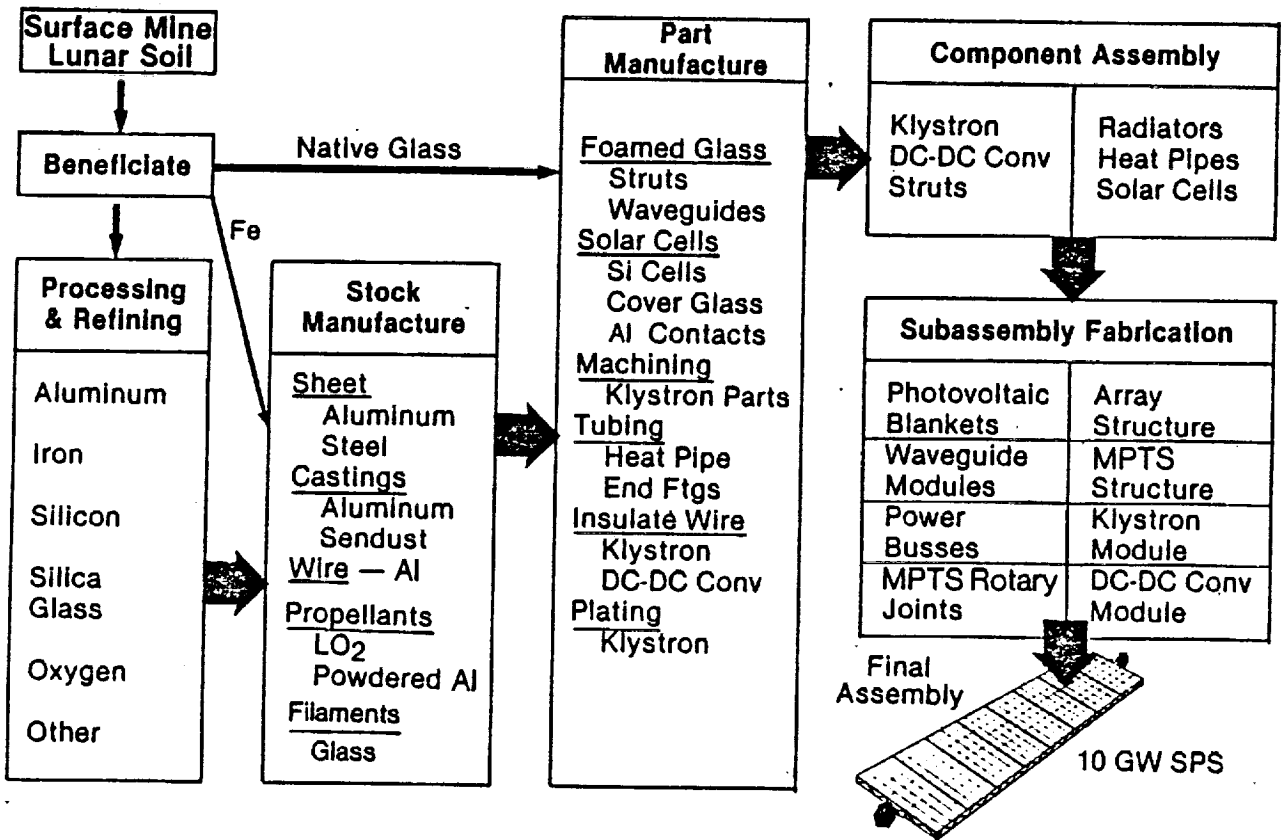

Figure 4-9. Processing & Manufacturing Scope.

lunar material utilization level for construction of a 10 GW SPS. The following subsections address each processing/manufacturing area of Figure 4-9 to assess techniques, equipment requirements, and support functions for obtaining useful materials and products from lunar soil in a form suitable for application in SPS space construction. This information is formatted so that masses and costs of processing equipment are available as a function of processing rate for alternative concepts and processes. The discussion in this section includes a description of lunar materials and their extraction processes, product manufacturing techniques and component subassembly. SPS module fabrication and total satellite final assembly is not included since these operations and facility requirements are assumed to be identical to those for the Earth Baseline SPS.

4.4.1 THE LUNAR SURFACE - COMPOSITION AND CHARACTERISTICS. The surface of the moon is characterized by large dark areas, designated Maria, and light colored areas generally a kilometer higher in elevation than the Maria. These highland areas are severely cratered as a result of meteorite impacts. Chemical analyses of surface and slightly subsurface soil and rock samples have been performed on material collected by six Apollo and two Luna spacecraft (Reference 3).

The composition of the lunar crust, insofar as the sampling to date permits, is somewhat similar to that of earth's, in that oxygen and silicon comprise the major elements, and at least eight of the ten most abundant elements in the earth's crust are also among the most prevalent in the lunar crust. Of the 10 most abundant elements in earth's crust, see Table 4-6, only hydrogen, at approximately 50 ppm, exists in only trace quantities on the moon. In addition, sodium and potassium are only one-twenty-fifth to one-tenth as plentiful on the moon as on earth.

A distinguishing characteristic of the lunar crustal surface is its relatively homogeneous composition as compared to earth. While there is some distinctive difference in composition between mare and highlands soils, particularly with respect to titanium, iron

Table 4-6. Earth & Lunar Crustal Compositions.

Earth Rank	Element	Earth PPM/Wt	Moon (PPM/Wt)	
			Mare	Highlands
1	Oxygen	466,000	417,000	446,000
2	Silicon	277,000	212,000	210,000
3	Aluminum	81,300	69,700	133,000
4	Iron	50,000	132,000	48,700
5	Calcium	36,300	78,800	106,800
6	Sodium	28,300	2,900	3,100
7	Potassium	25,900	1,100	800
8	Magnesium	20,900	57,600	45,500
9	Titanium	4,400	31,000	3,100
10	Hydrogen	1,400	54	56
11	Phosphorus	1,050	660	500
12	Manganese	950	1,700	675
17	Carbon	200	100	100
20	Chlorine	130	26	17
21	Chromium	100	2,600	850

and aluminum, there is little variation from location to location within each of the two areas, insofar as determined by soil analyses conducted to date.

Unlike on earth, no concentrations of specific minerals have thus far been found on the moon. For example, while the carbon content of the earth's crust is only twice that of the moon's, 200 ppm versus 100 ppm, enormous deposits of nearly pure carbon (coal) occur in many locations on earth, while the moon carbon appears to be quite uniformly distributed over the entire lunar surface. Thus, except for very few elements, there does not appear to be any preferable location for mining insofar as concentration of specific elements is concerned. An extensive geological survey of the lunar surface to locate possible ore bodies is warranted before initiating major mining operations.

The principal lunar derived elements required for the SPS, namely oxygen, silicon, aluminum and iron all occur in lunar soil in quantities varying from 5% to 45% by weight, with oxygen and silicon being relatively uniform in distribution regardless of location. Aluminum is more prevalent in highlands soil and iron in mare regions.

Other metallic elements which may be useful as propellants, alloying agents in aluminum and iron alloys, or for various other applications include calcium, magnesium, titanium, chromium, sodium, manganese and potassium.

Trace elements available in low to 100's of ppm are also listed. Many of these are recoverable from lunar soil by simply heating it and recovering the evolving gases. This is especially true for hydrogen, which has been uniformly deposited by the solar wind in the top several centimeters of lunar soil.

A third source of lunar materials is basin ejecta. The basin ejecta consists of a combination of lunar rock and meteoric material. The lunar rock is lunar soil which has been lithified by the meteoric impact. This material is also referred to under the acronym KREEP

since it tends to be high in potassium (K), Rare Earth Elements and Phosphorus.

The lunar surface and near subsurface are anhydrous and essentially devoid of carbon and organic material. They consist of rock, complex metal oxides and silicates. As described in the Handbook of Lunar Materials (Reference 3), the principal lunar minerals consist of plagioclase feldspars, olivine and pyroxene. Significant amounts of ilmenite occur in mare regions, and small amounts of spinels and lesser amounts of many other minerals are widely distributed over the lunar surface. Table 4-7 lists the principal minerals in lunar materials.

Table 4-7. Percent Occurrence of Minerals in Lunar Materials.

Mineral *	Mare Basalt	Anorthositic Rocks	Crystalline Breccias	Vitric Breccias	Fragmental Breccias	Light Matrix Breccias	Soil
Plagioclase ($\text{CaAl}_2\text{Si}_2\text{O}_8$)	15-35	40-98	50-75	15-50	-	70-90	10-60
Ilmenite (FeTiO_3)	0-25	trace	1-2	-	2-12	-	0.5-5
Olivine (Mg_2SiO_4 , Fe_2SiO_4)	0-35	0-40	1-5	-	0-5	-	0-4
Pyroxene (MgSiO_3 , CaSiO_3 , FeSiO_3)	40-65	0-40	-	-	5-30	-	5-20

* Compositions of principal constituents are shown for each mineral.

The lunar plagioclase feldspars consist primarily of anorthite ($\text{Ca Al}_2\text{Si}_2\text{O}_8$) in amounts exceeding 80%, with the remainder consisting of albite ($\text{Na AlSi}_3\text{O}_8$) and orthoclase (KAlSi_3O_8). Olivine consists of solid solutions of forsterite (Mg_2SiO_4) and fayalite (Fe_2SiO_4) and contains limited amounts of calcium, chromium, titanium

and aluminum in solution. The lunar pyroxenes contain a mixture of enstatite (MgSiO_3), wallastonite (CaSiO_3) and ferrosilite (FeSiO_3), with varying amounts of oxides of aluminum, titanium, manganese, chromium and sodium in solution. The amounts of the latter three oxides in pyroxenes are generally under 1%. Ilmenite minerals are mixtures of ilmenite (FeTiO_3) and small amounts of geikielite (MgTiO_3) along with other minor constituents. Lunar spinels are complex mixtures of Fe_2TiO_4 , FeCr_2O_4 , FeAl_2O_4 , MgCr_2O_4 , MgAl_2O_4 and Mg_2TiO_4 , and contain many minor and trace elements.

The lunar soil has been highly pulverized by meteoric impact, and the lunar surface is covered by a fine, silty and angular sand with a scattering of angular rocks. This fragmented material consists of as much as 25% by weight under 20 μm in diameter and more than 70% under 150 μm in size. Approximately 90% by weight of the lunar soil consists of particles under 1 mm in size. Much of the soil exists as agglutinates of stone and mineral fragments bonded together by glass droplets which became molten by meteoric impact and then resolidified. Free glass and iron particles are also present, the latter amounting to 0.15 - 0.20% by weight of the lunar soil. The lunar highlands contain a higher percentage of plagioclase than the mare soils, with the latter being richer in pyroxenes, olivine and ilmenite.

All minerals listed in Table 4-7 contain appreciable amounts of oxygen, the element used in all LRU systems concepts as transfer vehicle propellant. Three of the four minerals contain silicon, the element most extensively used in SPS construction. While aluminum is a basic constituent of only plagioclase feldspars, it may also be dissolved to an appreciable extent in pyroxenes. Iron is present in ilmenite, olivine and, to a lesser extent, in pyroxenes. Depending upon the location, these four elements of interest occur in the concentration ranges shown in Table 4-8. Other prevalent element percentages are also identified.

Table 4-8. Lunar Materials Available.

	Elements	Percent by Weight		
		Mare	Highlands	Basin Ejecta
Identified as Principal Reqs For Constructing SPS	Oxygen	39.7-42.3	44.6	42.2-43.8
	Silicon	18.6-21.6	21.0	21.1-22.5
	Aluminum	5.5- 8.2	12.2-14.4	9.2-10.9
	Iron	12.0-15.4	4.0- 5.7	6.7-10.4
Other Useful Materials of ≥ 0.1% Availability	Calcium	7.0- 8.7	10.1-11.3	6.3- 9.2
	Magnesium	5.0- 6.8	3.5- 5.6	5.7- 6.3
	Titanium	1.3- 5.7	0.3	0.8- 1.0
	Chromium	0.2- 0.4	0.1	0.2
	Sodium	0.2- 0.4	0.3- 0.4	0.3- 0.5
	Manganese	0.2	0.1	0.1
	Potassium	0.06 - 0.22	0.07 - 0.09	0.13 - 0.46
Trace Elements Useful in Processing & Manufacturing	Hydrogen, Carbon, Nitrogen Fluorine, Zirconium, Nickel		100 ppm	
	Zinc, Lead, Chlorine, Sulfur, Other Volatiles		5 to 100 ppm	

While the concentrations of oxygen and silicon are fairly uniform in their distribution throughout the lunar surface, the concentrations of aluminum and iron vary by factors of approximately 3 to 4; each being highest in areas where the other is lowest. Aluminum is most abundant in highland locations and iron in mare regions.

The depth of the lunar soil, or regolith, varies considerably with location. The regolith depth of mare surfaces ranges from 2 to 10 meters (References 4 and 5). The highland areas, which are by far the oldest lunar features, have developed regoliths hundreds of meters to possibly kilometers deep (Reference 6 and 7).

EFFECT OF LUNAR ENVIRONMENT ON LUNAR MATERIALS TECHNOLOGY

The lunar surface environment is radically different from that of earth, being essentially anhydrous and characterized by a high vacuum. This environment, combined with the very low and widely dispersed amounts of crustal hydrogen and carbon must exert a significant effect upon the selection of lunar materials recovery processes.

When one examines the history of metallurgy on earth, it is immediately evident how profound was the effect of earth's environment upon the development of the art and science of metallurgy. Man first found native gold and meteoric iron in their free state and learned how to work these malleable metals. Then the more easily smeltable metals were refined as man discovered that heating their ores in a reducing environment (burning in a wood or coal fire) would permit the recovery of copper, zinc and tin. Undoubtedly these developments were initially the result of fortuitous accidents rather than deliberate design. To accomplish them required the availability of both concentrated ores and supplies of combustible fuel. As technology developed, more sophisticated methods were developed to win the more abudant metals from their ores. In addition, enriched ore bodies were discovered which permitted more efficient recovery of their metals. Available water supplies and chemicals were employed to leach and concentrate the desired metals and additional sources of energy were developed to effect the reduction of metallic compounds by thermal, electrical and chemical means.

The moon presents an entirely different combination of environments; little or no water, hydrogen and carbon, no fuel and no atmosphere to sustain combustion. Solar energy can, however, be effectively harnessed on the moon and in space. Since man cannot efficiently take earth's environment with him once he escapes his planet, he must free his thinking from earth's bounds and seek to exploit whatever new environment he finds himself in if he wishes to sustain himself there. This attitude has dominated the evaluation of techniques to develop a lunar based materials industry to support the construction of an SPS system from lunar derived materials. Table 4-9 outlines a number of ore separation, metal extraction and production processes that may lend themselves more readily or as readily to a lunar or space environment than to an earth environment.

4.4.2 MINING AND BENEFICIATION OF LUNAR REGOLITH ——— MINING -

The location of lunar mining sites will be determined by a number of factors including

Table 4-9. Materials Extraction & Manufacturing.
Processes Adaptable to Lunar & Space Environment

Separation Processes		Environmental Compatibility
Magnetic	}	Dry processes Low, zero & controlled gravity
Electrostatic		
Centrifugal		
Metal Extraction Processes		
Melting & Electrolysis	}	Solar energy Vacuum
Vacuum metallurgy		
New techniques		
Metal Shape Production Processes		
Vapor deposition	}	Solar energy Vacuum
Melting & casting		
Powdered metallurgy		

material requirements, processing methods, and the transportation technique used for delivering materials from lunar surface to an in-space construction site. If a mass driver catapult is assumed as the transport method, then an equatorial mining base located near 33.1 degrees east longitude appears to be the best choice (Reference 8,9). If conventional or lunar material propelled chemical rockets are assumed the mining site selection is less constrained. Polar locations may even be suitable if the increased lunar transfer vehicle fleet size and/or propellant requirement needed to accommodate the inclination correction is tolerable. To maintain flexibility it would be desirable to locate the lunar mining base convenient to both highlands and mare regions. Thus revised material requirements could be easily accommodated without base relocation or institution of inefficient surface transport techniques.

Considering the sandy nature of the lunar soil, the least expensive method of mineral

collection would undoubtedly be by surface mining, using scraper-loaders and transporting soil via surface vehicles or conveyors to a nearby beneficiation or space transportation facility. Automated material collection is desirable since operations are repetitious and long term exposure on the lunar surface may subject workers to harmful radiation during periods of solar flare activity. An excellent study of a "lunar strip mining system" has been performed by Dr. David Carrier for the Lunar and Planetary Institute (Reference 10). His recommended system uses remotely controlled skip loaders and haulers to collect and transport lunar soil to the lunar base processing or launch facility. His analysis considers on and off-site beneficiation and a wide range of operational sensitivities. One conclusion of this work is that the beneficiation location and degree of beneficiation performed has a significant influence on mining operations and equipment requirements.

The data of Reference 10 for transporting all surface mined material to the central lunar processing plant has been used to estimate mining equipment requirements. This data, included in the left hand portion of Figure 4-10 was derived using conservative assumptions for equipment mass and mining efficiency.

BENEFICIATION

Under all proposed LRU scenarios and systems concepts, beneficiation of lunar soil is done on the moon and in close proximity to the mining site or sites, since the transport of gangue is uneconomical and the moon's gravity allows initial separation of minerals by sieving, electrostatics, or magnetically.

The degree of beneficiation to be performed on lunar soil depends upon the specific materials which are to be recovered. Lunar material requirements for construction of satellite power systems is limited to lunar derived oxygen, silicon, aluminum, iron and glass. Free iron and glass particles can be recovered from lunar soil by combinations of sieving, magnetic and electrostatic separation.

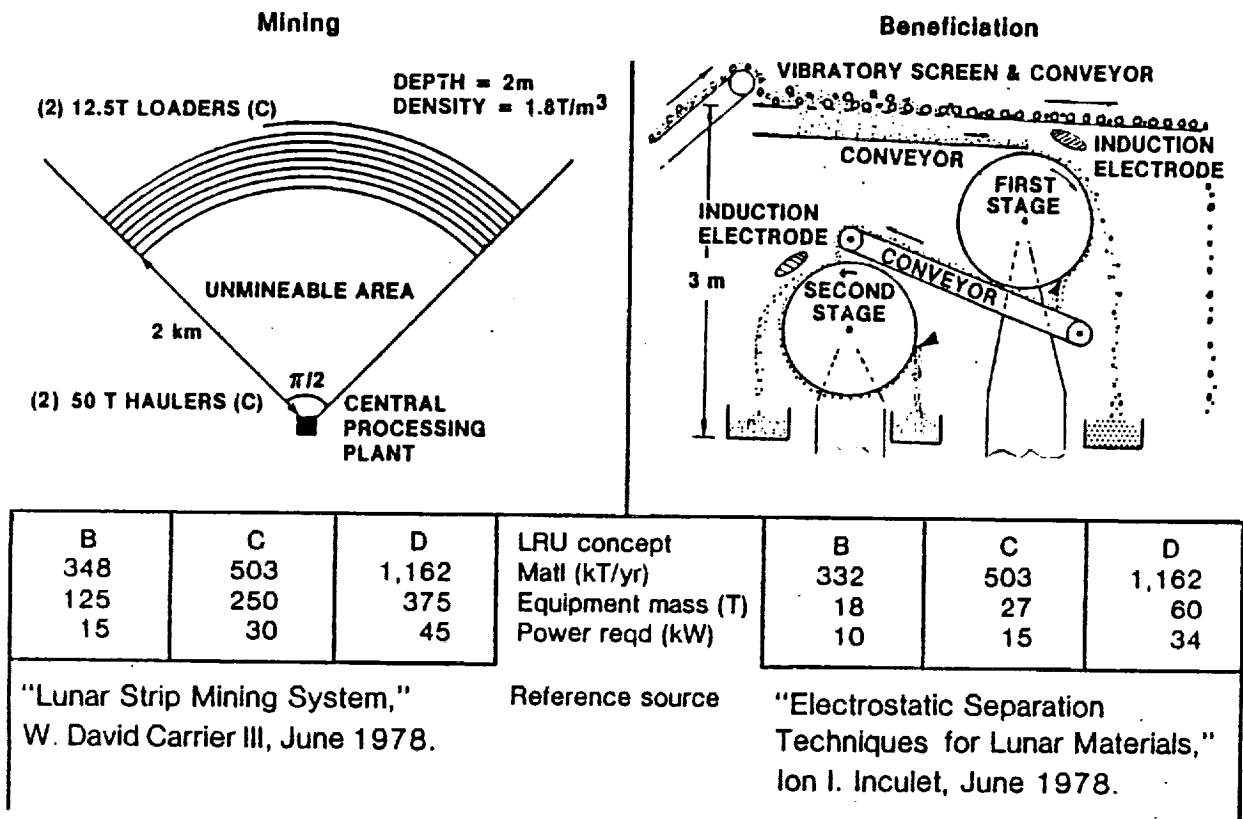

Figure 4-10. Mining & Beneficiation.

The combined oxygen requirements for propellant and high quality silica glass (solar cell covers and substrate) constitute significant lunar material recovery requirements for LRU systems concepts. Silicon is the most needed element in Concept B, oxygen is the primary element needed in Concept C, while aluminum propellant requirements are dominant in Concept D.

The recovery of oxygen and silicon from lunar soils would not be aided per se by beneficiation. Since pure anorthite contains in excess of 19% aluminum as compared to its 5 to 15% concentration in lunar soils, beneficiation to separate and extract anorthite could be advantageous when aluminum is the chief material being recovered. Likewise, beneficiation to concentrate ilmenite, which contains 36.8% iron, would be desirable when iron is the material being sought. However, since both aluminum and

iron, along with oxygen and silicon are required for the SPS and its support missions, beneficiation to concentrate any of these four elements may not prove particularly advantageous except in the cases of free iron and glass particles.

As previously mentioned, these two materials may be separated by magnetic and electrostatic means respectively. Fine particles of glass constitute a significant percentage of the finer fractions of lunar soil. For example, a sample of Apollo 17 mare soil showed 11.4% by weight to fall in the size range of 45-90 μm . Of this, more than 25% by volume consisted of glass particles (Reference 3, Table 7-a). Glass particles account for an even greater proportion of the very fine fractions of lunar soil, constituting 30 to 50% by weight of the 5-10 μm size range (Reference 11).

The presence of large quantities of fine glass particles in lunar soil is particularly relevant to the recommended use of foamed glass as primary structure for the SPS solar array and antennas. Foamed glass is commercially manufactured from fine particles of ground glass by the addition of small quantities of foaming agents and the application of heat. Thus beneficiation of lunar soil to recover the large amounts of fine glass particles may permit the direct production of all of the foamed glass needed for the SPS with few or no intermediate steps required to prepare the glass for foaming.

The recovery of the free iron in lunar soil by means of magnetic separation can provide a significant proportion of this metal's requirements for the SPS. By magnetic separation, each 100,000 tons of lunar soil may yield 150 - 200 tons of iron.

It is proposed to beneficiate lunar soil by first sieving it to separate it into two size fractions, one under and one over 90 μm in diameter. The former will approximate 60% and the latter 40% of the mass of the lunar soil. The under 90 μm size fraction is further processed by magnetic and electrostatic separation to recover iron and glass particles respectively. The glass particles may represent 1/3 of the mass of

the smaller size fraction, or approximately 20% of the lunar soil mass. The remainder of the smaller size fraction can then be processed to recover oxygen, silicon, aluminum and the remainder of the iron needed for the SPS and its support facilities. By using this approach and assuming an appropriate element recovery percentage during processing, the total quantity of lunar soil which must be mined and beneficiated can be determined for each systems concept. Since beneficiation is used only for the purpose of separating glass particles and free iron from the bulk of lunar soil prior to further processing, and no soil is discarded prior to processing, beneficiation should be restricted to either the lunar processing plant or the space manufacturing facility. Beneficiation at the mining site only makes sense if substantial amounts of gangue can be separated and deposited at the mine prior to transporting the ore to a processing facility.

Mass and power requirements for beneficiation equipment have been estimated from data contained in Reference 12. This work, conducted by Dr. Ion Inculet for the Lunar and Planetary Institute, assumed use of mobile beneficiation equipment at the mining site. The information contained in the right-hand portion of Figure 4-10 is for fixed beneficiation equipment located in (or near) the central lunar processing plant. Equipment mass has been derived from Reference 12 data by assuming that 37% of Dr. Inculet's equipment mass estimate was allocated to mobility functions. Power estimates were applied directly based on data contained in Table 3 of Reference 12.

4.4.3 EXTRACTION OF MATERIALS FROM LUNAR REGOLITH

Whether performed on the lunar surface or in the SMF, the extraction of metals and oxygen from lunar soil will require energy and the use of some materials and facilities which must be imported from earth. These will include at least one or more of the following: hydrogen, carbon, chlorine, acids, special catalysts, water, solar collectors, tanks and piping, pumps and power supplies.

It is generally agreed that most earth-based processes for smelting and refining of metals are not applicable to the lunar or SMF environments because they employ considerable quantities of other materials and equipment which are not available on the moon and must be brought up from earth. A variety of processes have been proposed for the extraction of lunar materials, most of which have not been reduced to practice and many of which have little other than theoretical bases for their justification. A comparison of these processes for reducing lunar soil to obtain useful constituents is contained in Table 4-10.

Assessment of these processing techniques must be accomplished for the particular material requirements associated with construction of satellite power systems and manufacturing of propellants for cargo transfer. Previous processing investigations have not considered exclusive extraction of just a few lunar soil constituents, and have not accounted for the very large oxygen propellant requirement.

This overriding requirement for oxygen propellant necessitates a re-examination of the extraction processes which have been proposed for the recovery of lunar materials. Another important factor dictating a review of the possible lunar material recovery options is that the LRU study recommendation for lunar materials utilization involves major usage of only four of the seven lunar elements which exist in concentrations in excess of 1% by weight. These four are oxygen, silicon, aluminum and iron. It would obviously be most efficient if materials extraction processes could be developed which confine themselves to the materials of interest and which do not require extensive chemical and mechanical processing of unneeded materials.

The two processes which have been suggested by Dr. R. D. Waldron (Reference 13), involve essentially wet chemical reactions requiring solution of the beneficiated lunar regolith in an acid or base, followed by selective precipitation, hydrolysis, electrodeposition or ion exchange reactions to extract specific elements and compounds. These processes involve the transport from earth to the moon or space

Table 4-10. Suggested Processes for Extraction of SPS Materials From Lunar Soils.

<u>Extraction Process</u>	<u>Status</u>	<u>Applicable to</u>		<u>Problem/Risk Areas</u>
		<u>Moon</u>	<u>SMF</u>	
Carbochlorination, electrolysis of fused salts or reduction by reaction with metals	Some pilot plant experience	No	No	Requires carbon, chlorine and water from earth. Impractically large amount of chlorine, power and carbon pyrolysis facility may be required.
Carbothermic and silicothermic reductions; electrolysis or reduction by chemical reactions.	Pilot plant operation on earth	No	No	Serious materials problems at temperatures > 2,000°C. Requires large amounts of earth supplied materials and process equipment.
Acid leach (HF) or basic leach (NaOH), followed by electrolysis, ion exchange, etc.	Theoretical	Yes	Yes	Requires acid bases, sodium, other chemicals, water and complex chemical processing equipment transported from earth. Corrosion and equipment leakage, variable solubility of fluorides, and Na-O ₂ electrolysis may pose technical problems.
Electrolysis of in-situ molten lunar soil.	Experimental	Yes	Yes	High chemical stability of SiO ₂ may limit oxygen and silicon recovery by electrolysis and necessitate alternative process for silicon extraction. Solar collector and power equipment for electrolysis must be transported from earth.
Volatilization of lunar soil and fractional distillation.	Theoretical	Possibly	No	High temperatures required, severe materials problems, no experimental work has been done.
Reduction of molten lunar soil by methane, followed by electrolytic separation.	Experimental	Yes	Yes	Requires large amount of methane and high temperature crucibles transported from earth. Exothermic reactions require dissipation of large quantities of heat.
Soda-lime sintering	Pilot plant operation	No	No	Requires large amounts of CaCO ₃ , Na ₂ CO ₃ and water transported from earth.

manufacturing facility of water, acids or bases, tanks, piping, pumps, materials handling machinery and other more or less standard earth chemical processing equipment.

In order to minimize the transport of earth materials to lunar or space facilities, the proposed extraction processes necessitate a closed system with essentially complete recovery and recycling of water and chemicals (fluorine, sodium, etc.). Since most of the process chemicals also react with the unneeded lunar materials, these must also be recycled and recovered by further chemical processing, greatly complicating the entire lunar materials extraction system. This becomes especially unwieldy when the requirement for one lunar material greatly overshadows the rest or when only a few of the many elements present in lunar soil are needed.

A further difficulty with the proposed aqueous chemistry extraction processes is the fact that leaks in any system could result in catastrophic losses of gaseous or liquid reactants, resulting in system shutdowns and the need to replace water and chemicals by further transport from earth. Normal earth based aqueous chemical processing plants, particularly those using strong acids and bases, are frequently plagued by leaks. The reliability of lunar or space based plants of this type is suspect.

It must be constantly kept in mind that the moon is essentially carbon- and water-less, and has relatively low amounts of strong acid or base forming elements. These four ingredients constitute the foundation for normal earth types of hydro- and pyrometallurgical extraction processes. The lunar and space environments differ radically from earth's; the former is characterized by high vacuum, reduced or no gravitational attraction and ready access to solar irradiation the entire time the lunar surface or space manufacturing facility is exposed to sunlight. It would thus be advantageous to consider material extraction processes utilizing as many as possible of the lunar or space environmental characteristics and a minimum of earth's.

The lunar materials extraction process proposed for the Lunar Resources Utilization for Space Construction Study involves melting of the lunar regolith by solar heating, followed by electrolytic reduction of the molten mass to recover oxygen, silicon, aluminum and iron. This melting can conceivably be accomplished in situ, or with a flow-through furnace constructed primarily of lunar material.

MELTING AND ELECTROLYSIS OF LUNAR SOIL

The initial concept for solar melting of lunar soil considered the use of a mirror system equivalent to 500-800 suns capable of generating a flux density of 900 kW/m^2 in the focal zone. Since solar heating is only feasible during the lunar day, lunar equatorial processing facilities are constrained to operating during a ~ 320 hour period every 28 earth days. The optimum location for a solar melting facility is at the lunar pole where sunlight is constantly available, although transportation considerations make polar locations less desirable.

For in-situ melting, application of 900 kW/m^2 will result in very rapid surface melting, but the very low thermal conductivity of lunar soil will greatly impede heat transfer to and delay melting of subsurface material. The conductivity at the mean lunar surface temperature of 216°K is approximately $1.5 \times 10^{-5} \text{ W/cm-K}$. This very low value results both from the inherent low thermal conductivity of silicates and the low bulk density of the lunar surface soil. In-situ measurements of the thermal conductivity of lunar soil made during the Apollo 15 and 17 moon flights yielded somewhat higher values of 1.4 to $3.0 \times 10^{-4} \text{ W/cm-K}$ at depths of 50 to 250 cm below the surface. This was attributed to the large increase in soil compaction and grain boundary contact with depth (Ref. 14). Lunar soil temperatures at these depths are in the range of 250 - 255°K .

The low thermal conductivity of lunar soil thus makes it infeasible to melt material within a reasonable period by directing heat down onto the lunar surface. Solar melting could be more efficiently performed if the newly molten material were constantly removed, exposing fresh solid material to the solar radiation.

This can be done either in situ by tunneling, or by constructing a furnace which provides a constant flow of lunar material through the focal plane of a solar mirror. One technique of accomplishing this is shown in Figure 4-11. The furnace is constructed by tunneling both horizontally and vertically into a mound of lunar material, focusing the mirror system into the horizontal bore, and dropping lunar soil down the vertical shaft onto a ledge in the focal zone. The material is melted in the focal zone and runs off into a well in front of the ledge. The material in the well remains molten and is superheated by the radiant energy within the horizontal shaft. A drain is provided for removing molten slag, so a fresh charge can accumulate in the well.

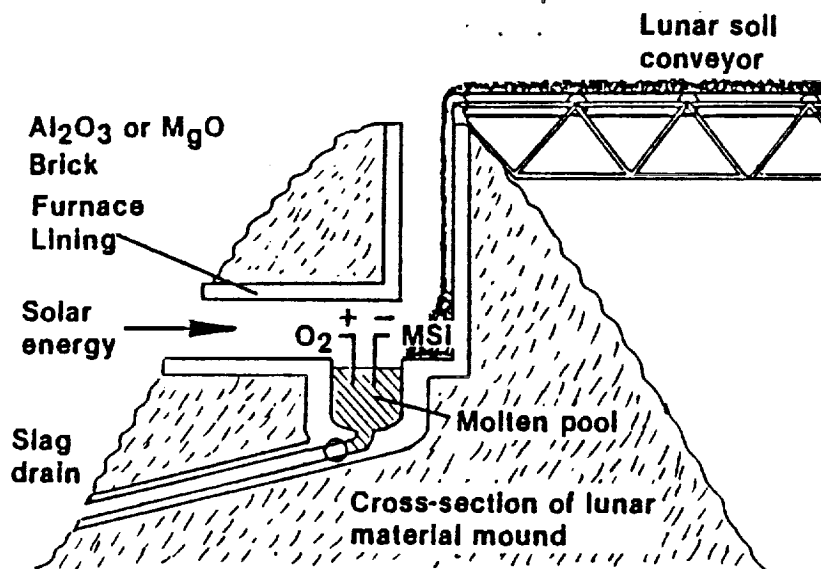

Figure 4-11. Proposed Lunar Material Melting Facility.

Earth type basalts and shale having chemical compositions approximately similar to that of lunar soils have liquidus temperatures in the range of 1200-1300°C (Ref. 15). These minerals are quite viscous at and near their melting temperatures and, if electrolysis is to be successfully accomplished, their fluidity must be increased. One desirable technique for decreasing viscosity is by fluxing, preferably with halogen salts, which minimize operating temperature and electrode materials problems and improve bath electrical conductivity. This would require the transport of considerable quantities of fluxing materials from earth, however,

since halogen compounds are not available on the moon except in very minute amounts. As an alternative it may be possible to employ lunar minerals as fluxes to reduce the melting points of lunar soils and increase their fluidity. Ilmenite, wallastonite (CaSiO_3) and other lunar minerals when added to anorthite or anorthosite produce eutectics having melting points several hundred degrees lower.

Raising the temperature will also increase fluidity, but at the cost of aggravating electrode materials problems at the higher operating temperatures. Since the molten pool is within the horizontal bore, its surface will be exposed to the radiant energy traversing the shaft and may be superheated by as much as 100-200°C above the liquidus temperature. With the molten lunar soil being contained within the mounded lunar regolith, the major materials problems will be confined to the electrodes and the oxygen and metal recovery systems.

Experimental work is needed to obtain data on the thermal conductivity, emissivity and thermal absorptivity of lunar anorthite and ilmenite at and near their melting temperatures. The rough calculations made for this study were based both on assumed values and published data on earth rocks of compositions that were different from the lunar materials.

More data are also needed on portions of phase equilibrium diagrams of the anorthite-olivine-pyroxene system to determine if lower melting point fluid electrolytes could be made by judicious beneficiation and mixing of lunar minerals. Consideration should also be given to the search for suitable fluxing materials which could be added in small amounts to lunar minerals to improve the operating characteristics of electrolytic cells.

Thermal analyses are necessary to more precisely calculate heat losses, thermal gradients in the lunar regolith surrounding the molten material, the sensitivity of heat losses to surface contamination and roughness of the molten pool, etc.

Thermal losses due to mirror materials and geometrical irregularities must be minimized to make solar melting feasible. Since mirror arrays of 450 to 800 suns (i. e. , mirror areas 450 to 800 times the surface area to be heated) represent a substantial area, the surface reflectivity, flatness and focusing of mirrors become critical. Mirrors made of light weight aluminized Kapton film mounted on a sun following system would provide the solar heating. A more extensive discussion of large solar furnaces and mirrors is included in Appendix C of Volume III.

Electrolysis of the molten lunar soil would be conducted to recover oxygen and the other materials required for fabricating SPS's and supporting the lunar and in-space facilities. These include aluminum, silicon, iron and glass. It is estimated that at 100% efficiency, approximately 85 MW of electrical energy is sufficient to produce 100 metric tons of oxygen during 12 hours of operation. Probably 50% efficiency is the most that can be practicably attained. Control of voltage during electrolysis of the molten lunar soil permits extraction of aluminum, iron, and silicon. The high chemical stability of SiO_2 will require high levels of power to disassociate it, possibly resulting in arcing at the electrode-electrolyte interface at the high voltages necessary. This may limit the amount of oxygen which can be recovered from lunar soil to approximately 50% of its total quantity; i. e. , the amount of oxygen which can be recovered from lunar soil to approximately 50% of its total quantity; i. e. , the amount of oxygen linked to other than silicon. This may also necessitate consideration of alternative processes for recovering elemental silicon. Appendix C provides additional information on the electrolysis of lunar soil.

Depending upon the specific end use requirements, glass will probably be provided from two sources; from beneficiation of the $< 90 \mu\text{m}$ particle size fraction to recover free glass and from the chemical recombination of silicon and oxygen to make high purity silica glass. Iron will also be obtained from two sources; magnetic beneficiation of free iron ($\cong 0.15\%$ of lunar soil), and by electrolysis of molten lunar soil.

Limited prior work performed by the Bureau of Mines has demonstrated the feasibility of recovering oxygen from molten silicate rocks by electrolysis (Ref. 16). This was accomplished by dissolving the silicate rocks in molten halides and electrolyzing them at temperatures in the range of 1050 - 1250°C, using a silicon carbide cathode and an iridium anode. The melts were contained in a boron nitride crucible. Oxygen was liberated at the cathode while a variety of metals including iron, aluminum, silicon, sodium, barium, manganese, titanium, calcium and others accumulated at the cathode.

While the experimental work performed at the Bureau of Mines was limited, the results were encouraging in that cell gases containing 14 volume percent oxygen were obtained along with an anode current efficiency of 55%. Problems were initially encountered with electrode corrosion, but these were successfully solved. More serious problems were encountered with the deterioration with time of the cell performance which was evident as increased electrical resistance of the melt and by a reduction in oxygen content being generated. In addition, relatively little electro-reduction of the silica was obtained during the experiments.

Iridium, which was used for the electrolysis anode material, is not only scarce but is very expensive and should be replaced by another refractory corrosion resistant metal. If none can be found, a molybdenum or tungsten anode with a thin iridium clad or electroplated surface could be used.

Research and development work will be necessary to optimize the electrolysis of lunar soils under lunar environmental conditions. Because of the effects of vacuum on the vapor pressures of metals at various temperatures, metals will be liberated at the cathode in solid, liquid and vapor form. Aluminum, calcium, magnesium, sodium, potassium and manganese would be in vapor form, iron and silicon may be liquid or solid depending upon bath temperature, while titanium will deposit on the cathode in solid form. Work is needed on the selection of materials and design of systems to remove the oxygen and other gases from the anode areas as well as liquid and vaporized metal from the cathode areas during electrolysis.

Refractory metal alloys of columbium, molybdenum and tantalum which have excellent strength and corrosion resistant properties at temperatures in excess of 1300°C are available, as are cobalt base alloys for use at temperatures up to 1200°C. The above materials may be used for the funnels and piping to remove both liquid and gaseous materials from the electrolysis cell, but their compatibility with molten lunar soils must be determined.

Based on these considerations and assessments of lunar material processing, it appears that beneficiation, melting and electrolysis of the lunar soil can all be more efficiently conducted on the lunar surface rather than in space. Probably the most important reason for this is that in some LRU systems concepts, the mass requirement for lunar derived oxygen exceeds that for most other materials by a considerable amount (see page 4-40). It would be inefficient to transport huge quantities of unneeded materials to the SMF if the separation of the constituents in lunar soil were to be done in that facility. Secondly, the beneficiation and reduction processes which have been proposed require some degree of gravity which is available on the moon but would have to be artificially created in the SMF (Ref. 12).

It is estimated that the equipment for the solar melting and electrolysis of lunar soil will weigh 2,500 tons and require 175 MW of energy. A list of the equipment and their masses is given on page C-6 of Appendix C.

4.4.4 MANUFACTURE OF STOCK MATERIALS

a. Aluminum Sheet and Wire

Aluminum metal is obtained by the electrolysis of molten lunar soil which had previously been partially beneficiated. Electrolysis in the lunar vacuum environment produces vapors of the lower boiling point metals including aluminum, magnesium, calcium, sodium, potassium, manganese and some minor constituents of lunar soil. Aluminum and other metals as required can be essentially quantitatively recovered from this mixture by selective electrodeposition at predetermined voltage levels. Separation can also be achieved by vacuum distillation.

The aluminum prepared in this manner is of high purity and very low strength, with a yield strength of approximately 30 MPa (4000 psi) and a tensile strength of 80 MPa (12000 psi). Higher strength aluminum can be produced in a variety of ways; by cold working the unalloyed material, by alloying, by combinations of alloying and cold working and by alloying and heat treatment. Alloying can be done with other ingredients available in and extractable from lunar soils, including silicon, magnesium, manganese and chromium. The ranges of strength properties of equivalent standard alloys are listed in Table 4-11.

The wrought alloys listed in Table 4-11 have been cast into ingots and subsequently hot rolled into thin sheet and plate form while the cast alloys have been solidified in sand or plaster molds. The lower values represent the properties in the unheat-treated, not cold worked conditions. The only wrought alloys listed in Table 4-11 which can be strengthened by heat treatment are the 6000 series alloys, which require rapid cooling by quenching in water from an elevated temperature followed by a low temperature aging treatment. Casting alloys 356 and 360 are also heat-treatable to high strength levels.

Aluminum extracted from lunar minerals can be formed into sheet and wire by a variety of processes which can be performed on the lunar surface or in a SMF. Various processes for producing aluminum and aluminum alloy sheet are listed in Table 4-12, with brief statements of their current status and problem/risk areas. The standard earth practice of melting aluminum in electric furnaces, casting into ingots, followed by reheating the ingots and rolling them down into plate and sheet form does not lend itself to lunar or SMF application. This practice is not only wasteful of energy because of repeated heating and cooling of the metal, but also involves a considerable amount of large and heavy operating equipment such as electric furnaces and power supplies, ingot molds, rolling mills and supporting equipment. In addition, a moderately high proportion of scrap is generated and must be recycled, adding further to the energy inefficiency.

Table 4-11. Aluminum Alloys Capable of Being Prepared From Lunar Materials.

Wrought Alloys

<u>Earth Equivalent Alloy</u>	<u>Composition</u>	<u>Yield Strength M Pa</u>	<u>Tensile Strength M Pa</u>	<u>Shear Strength M Pa</u>	<u>Fatigue Limit M Pa</u>
1350	99.60 + % Al	28-166	83-186	55-103	- -48
1100	99.00 + % Al	35-152	90-165	62-90	35-62
3003	1.2% Mn	41-186	110-200	76-110	48-69
6063	0.7% Mg, 0.4% Si	48-269	90-290	69-186	55-69
5050	2.5% Mg, 0.25% Cr	90-255	193-290	124-166	110-138
6101	0.5% Mg, 0.5% Si	103	138	117	62
5083	4.5% Mg, 0.75% Mn	124-214	275-303	-	-
5056	5.2% Mg, 0.1% Mn, 0.1% Cr	152-407	290-434	179-234	138-152
6151	0.9% Si, 0.6% Mg, 0.25% Cr	255	303	220	76

Cast Alloys

<u>Earth Equivalent Alloy</u>	<u>Composition</u>	<u>Yield Strength M Pa</u>	<u>Tensile Strength M Pa</u>	<u>Shear Strength M Pa</u>	<u>Fatigue Limit M Pa</u>
43	5% Si	55	131	97	55
214	4.0% Mg	83	172	138	48
A320	4.0% Mg, 0.5% Si	90	159	117	38
356	7% Si, 0.3% Mg	138-207	172-234	138-179	52-89
360	9.5% Si, 0.5% Mg	172	324	207	131

Vapor phase deposition of aluminum has previously been recommended for the fabrication of space structures and sheet metal for fabrication of SPS's and other products (References 17 and 18). Henson and Drexler (Reference 18) have outlined the possible use of both electron beam evaporation and solar metal vaporizer facilities for the preparation of aluminum sheet and structures in space. The vapor phase deposition of aluminum by electron beam evaporation is an established industrial process, with steel sheet up to 400 mm wide being coated with 3 μm thick aluminum at the sheet travel rate of 3 m/sec and evaporation rates up to 50 kg/hr (Reference 19).

More recently, high power axial electron beam guns have been developed capable of achieving aluminum deposition rates of 50 $\mu\text{m}/\text{sec}$ (Reference 20). These guns are rated at 1200 kW with a maximum accelerating voltage of 50 kV. A gun of this capacity can deposit aluminum at a rate of 50 $\mu\text{m}/\text{sec}$ over a deposition zone 0.5 to 1.0 m long.

Extensive work has been done on developing high rate physical vapor deposition of metals and alloys and evaluating the mechanical properties of metals so deposited. Bunshah (Reference 21) has reviewed work performed by him and his associates as well as by other researchers and has determined that the mechanical properties of vapor deposited metals and alloys can be comparable to those of the same metals made by casting, rolling and annealing.

Aluminum and aluminum alloys such as listed in Table 4-11 can be produced in sheet form either on the moon or in a SMF by electron beam evaporation and deposition on an endless belt made of woven carbon fabric, high temperature plastic film or molybdenum sheet from which the deposited aluminum sheet can be readily stripped. A continuously fed molten pool of aluminum or aluminum alloy is impinged by a magnetically deflected electron beam as shown in Figure 4-12 and the aluminum is evaporated and deposited on the endless belt. Production of wide or thick sheet aluminum will require several electron beam guns mounted abreast or in tandem. An

estimate of the vapor-deposited aluminum sheet manufacturing equipment is contained in the LRU element manufacturing data sheet Appendix D page D-4, of Volume III.

Appendix D contains a summary description of the production quantities and rates, manufacturing processes, types and masses of plant facilities and power required for the production of lunar derived materials stock, parts and component assemblies to produce one SPS per year. The appropriate pages of Appendix D will be referenced in the following discussions of materials stock, parts manufacture and components assembly.

Table 4-12. Processes for Manufacture of Aluminum Sheet.

<u>Mfg. Process</u>	<u>Status</u>	<u>Applicable to</u>		<u>Problem/Risk Areas</u>
		<u>Moon</u>	<u>SMF</u>	
Melt, cast into ingots or continuous cast, roll into sheet	Current earth mfg. process	Yes	Yes	Can involve excessively massive equipment
Electron beam * evaporation (Physical vapor deposition)	Currently being used to coat mild steel with aluminum	Yes	Yes	Mechanical properties and formability of PVD sheet.
Electrodeposition *	Deposition from both aqueous and fused salt baths are developed processes.	Yes	Yes, requires pseudo gravity	Requires water or chemicals supplied from earth.
Sheet formed by solidification of molten aluminum on partially immersed rotating water cooled steel drum.	Theoretical, no experimental work is known to have been done.	Yes	Yes, requires pseudo gravity	Process has not been previously attempted. Requires water or other coolant.

* PVD and electrodeposition of aluminum can both be done continuously on a carbon cloth substrate from which the aluminum can be readily stripped.

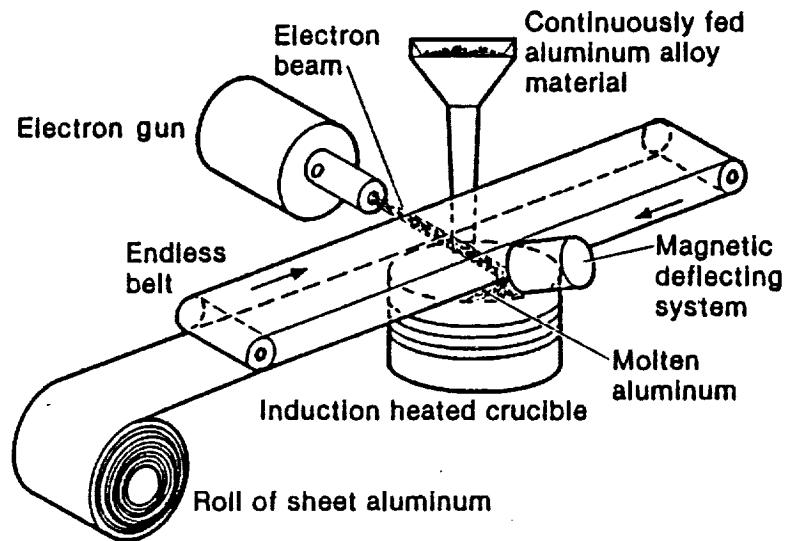

Similar technique proposed for other metals

Figure 4-12. Aluminum Sheet Production
Continuous Vapor Deposition

While mechanical properties and formability of vapor deposited aluminum sheet are listed as possible problem and risk areas, these are considered minimal since the high vacuum environment on the moon or in space will insure the absence of oxygen, the chief cause of aluminum embrittlement.

Aluminum wire is commercially manufactured by rolling the metal into bar, converting it into round rod and then drawing it into wire by pulling it through successively smaller dies. As in sheet rolling, these manufacturing operations involve heavy equipment and considerable power outlay. It is proposed to manufacture aluminum wire by slitting vapor deposited aluminum sheet into square cross-sectioned strips which would be subsequently pulled through one or more wire-drawing dies to the desired diameters. The vapor deposited high purity aluminum sheet will be slit by being passed through a two-high set of slitting rolls, and being in the dead soft, essentially annealed condition will require little power for the slitting operation. Since the square cross-section strips need be only slightly larger than the final wire diameter, the wire drawing operation will also require little power and light equipment.

The minimum wire drawing equipment can consist of a single-block, single-draft unit incorporating a water cooled tungsten carbide die positioned in front of a lubricant box, a wire-drawing block driven by an electric motor, and a stripper to remove the coiled wire. Definition of this equipment is contained in Appendix D, page D-5. If very long lengths of wire are needed, slit strips may be electric resistance butt welded together prior to wire drawing to provide whatever lengths are required.

Aluminum castings may be produced by casting molten metal in sand, plaster or permanent metal molds. Large numbers of small castings may be readily produced in automatic permanent mold machines equipped with a number of casting stations. A description of the equipment, production rate, equipment mass and power requirements to produce aluminum and aluminum alloy castings required for the SPS is given in Appendix D, page D-8.

b. Iron and Steel Sheet and Plate

Metallic iron is obtained from lunar soil by two means; first by magnetic separation of the free iron contained in the <90 μm size fraction and secondly by either chemical processing or electrolysis of molten regolith material. As pointed out previously, each 100,000 tons of lunar soil may yield 150-200 tons of free iron by magnetic separation. Free glass particles are also recovered from the fine fraction of lunar soil by means of electrostatic beneficiation.

After removal of the free iron and glass, the remainder of the fine fraction is then reunited with the coarser fraction of the regolith and then processed to obtain the various elements needed.

Iron and other metals can be produced either by the direct electrolysis of molten lunar material, by electrolysis of metallic salt aqueous solutions, or by the Aerojet-General carbothermic (methane) process. Iron can then be quantitatively separated

from the other metals by various means such as electroplating at a controlled voltage, vacuum distillation and fractional solidification, acid solution and selective precipitation, etc.

High purity iron has very low strength properties, but when alloyed with 0.2 to 0.5% carbon to make steel, it has good strength and ductility and finds wide use in engineering applications. Still higher strengths along with good ductility and resistance to brittle fracture can be achieved by further alloying with a fraction of 1% to several percent by weight of manganese, silicon, chromium and nickel, either separately or in various combinations of several of these elements. Many of the alloy steels can be further strengthened by heat treatments consisting of rapid cooling from elevated temperatures followed by reheating to lower temperatures, reference Table 4-13.

Except for silicon, the steel alloying elements exist in very limited quantities in the lunar regolith as shown below: (Reference 22)

<u>Element</u>	<u>Range of Lunar Concentration</u>	<u>Lunar Region of Highest Concentration</u>
Carbon	80-155 ppm	basin ejecta
Manganese	0.05-0.19%	Mare
Chromium	0.07-0.36%	Mare
Nickel	130-345 ppm	Highlands and basin ejecta.

Lunar carbon, hydrogen, and other gases result from the solar wind and are generally concentrated in the finer grain size particles located on the exposed lunar surface. These constituents are given off as gases during heating of the soil in the temperature range of 200-900°C. Higher temperatures approaching the melting point of the soil release additional carbon in the form of CO and CO₂. Other gases are also evolved during the heating of lunar soil, including H₂S, CH₄, SO₂, N₂, H₂, He and H₂O (Reference 3). These gases may be collected from the lunar soil entry port of the melting furnace depicted in Figure 4-11. Entrapment of these volatiles can conceptually

Table 4-13. Iron and Steel Alloys Capable of Being Made From Lunar Materials.

<u>Alloy</u>	<u>Nominal Chemical Corporation</u>	<u>Condition</u>	<u>Yield Strength</u> <u>M Pa</u>	<u>Tensile Strength</u> <u>M Pa</u>
Iron	99.9+ Fe	Electron beam vapor deposited.	175	265
1330 Steel	0.30C, 1.75 Mn, 0.30 Si	Rolled, annealed.	345	460
1330 Steel	" " "	Rolled, quenched and tempered at 810°K.	480	620
2330 Steel	0.30C, 0.70 Mn, 0.30 Si, 3.50 Ni	Rolled, annealed.	450	620
2330 Steel	" " "	Rolled, quenched and tempered at 810°K.	620	910
5130 Steel	0.30C, 0.80 Mn, 1.00 Cr, 0.30 Si	Rolled, annealed.	410	620
5130 Steel	" " "	Rolled, quenched and tempered at 810°K	1000	1170
9250 Steel	0.50C, 0.85 Mn, 2.00 Si	Rolled annealed	550	790
9250 Steel	" " "	Rolled, oil quenched and tempered at 810°K	1100	1240
-	0.40C, 1.00Mn, .25 Si, 0.50 Ni, 0.50 Cr	Rolled, annealed	620	725
	" " " "	Rolled, oil quenched and tempered at 810°K	930	1070
410 Cast Stainless Steel	0.15C, 1.0Mn, 1.0Si, 11.5/13.5 Cr	Air Cooled from 1255°K tempered at 1030°K	520	760
Tenelon Stainless Steel	0.10C, 1.0 Si, 18 Cr, 14.5 Mn, 0.4N	Annealed	480	860
Class 30 Cast Iron	2.90/3.20 C, 1.70/2.10 Si, .45/.70Mn	--	--	210
Nodular Cast Iron	3.20/4.10, 1.80/2.80 Si, .45/.80 Mn	--	310/480	410/690

be accomplished by sealing the furnace solar heating port with a silica glass window which is transparent to solar radiation, and by employing an intermittent lunar soil feed into the melting furnace through a vacuum seal. Sealing the furnace in this manner permits collection of the gases evolved from the lunar soil.

The various gases may be separated by fractional liquefaction and the carbon recovered from CO and CO₂ by reduction in a Bosch reactor (Reference 23). LRU system Concept B calls for processing the minimum quantity of lunar soil, 381,000 tons. Assuming a carbon content averaging 100 ppm, it is theoretically possible to recover 38 tons of carbon. It should be possible to achieve a recovery efficiency of at least 50%, or 19 tons of carbon. If the 4770 tons of iron required by Concept B were to be in the form of steel containing a carbon content of 0.30%, a total of 14.3 tons of carbon would be required to produce the steel. While the margin is not great, the system concept that entails processing the minimum quantity of lunar soil still produces enough carbon to furnish the required amount of steel. In any case, if more carbon is needed, additional soil can be heated to recover trapped gases.

Manganese and chromium can be recovered from the molten lunar soil by electrolysis and subsequent electroplating at controlled voltages or by vacuum distillation. Since these two metals are significantly more prevalent in mare soils, the latter may be cast into any required shape by being poured into a sand, plaster or chilled metal mold, with gravity required to feed the metal to completely fill the mold.

Table 4-14 lists a number of processes for the manufacture of various iron and steel products which may find an SPS application. The attendant problem and risk areas for each process are summarized in the table.

Electron beam vapor deposition is considered the optimum process for the preparation of iron and steel alloys in the form of sheet and thin plate material. Sheet materials of good strength and ductility properties have been made by this method (References 21

Table 4-14. Processes for Manufacture of Iron & Steel Products.

Sheet & Plate

<u>Mfg. Process</u>	<u>Status</u>	<u>Applicable to</u>		<u>Problem/Risk Areas</u>
		<u>Moon</u>	<u>SMF</u>	
Melt, cast into ingots or continuous cast into bar, roll into plate or sheet	Current Earth Mfg. Processes	Yes	Yes	May require excessively massive equipment
Powder rolling, sintering and rerolling	Has been reduced to practice	Yes	Yes	Has width and thickness limitations. Additional facilities required to produce metal powders
Electron Beam Vapor Deposition (Physical vapor deposition)	Currently being used to apply metal coatings to substrates	Yes	Yes	Separation of PVD sheet from substrate. Control of mechanical properties of PVD material.
Electrodeposition	Deposition from aqueous solutions is a developed process	Yes	Yes requires pseudo gravity	Requires water and acids either supplied from earth or synthesized from materials extracted from lunar soils. Separation of Electrodeposited sheet from substrate.
<u>Tube & Pipe</u>				
Extrusion of Cast or Rolled billet	Current earth mfg. process	Yes	Yes	May require excessively massive equipment
Sheet spiral wrapped into tube and helically welded	Process has been developed	Yes	Yes	No major risks
Sheet roll formed into tube and straight line welded	Current earth mfg. process	Yes	Yes	No major risks

Table 4-14. Processes for Manufacture of Iron & Steel Products (Continued)

Shaped Parts

<u>Mfg. Process</u>	<u>Status</u>	<u>Applicable to</u>		<u>Problem/Risk Areas</u>
		<u>Moon</u>	<u>SMF</u>	
Forging	Current earth mfg. process	Yes	Yes	May require excessively massive equipment
Casting	Current earth mfg. process	Yes	Yes, may require pseudo gravity	No major risk
Powder Metallurgy	Current earth mfg. process	Yes	Yes	May require excessively massive equipment

and 24). The 99.9+% iron listed in Table 4-13 was deposited in thicknesses of 0.8 to 2.0 mm on substrate material heated to 500°C and achieved 35% elongation during tensile testing (Reference 24). Ready separation of the vapor deposited iron from the substrate was provided by the prior deposition of a thin layer of a refractory compound which did not interact with the iron. Bunshah has demonstrated that at high deposition rates there is a change in morphology from columnar to equiaxed grain structure in iron and iron-nickel alloys vapor deposited on substrates heated to temperatures approximately one-half the melting temperature of the deposited metal (Reference 21). An equiaxed grain structure exhibits good ductility.

Electron beam guns of the type used for the deposition of aluminum, reference Figure 4-12 can also be used for the manufacture of iron and steel sheet. The substrate on which the sheet material is deposited may consist of an endless belt of a high temperature alloy with a highly oxidized surface to permit ready separation of the deposited metal which will be stripped off the belt and coiled. The alloy constituents may be co-deposited with the iron by means of vacuum deposition.

Details of the required production rates, manufacturing process, equipment and power requirements for iron and steel sheet and plate are contained in Appendix D, pages D-6 and D-7.

The DC-DC converter transformer core is an iron base casting containing 10% silicon and 5% aluminum. This casting can be produced by means of the process and equipment described in Appendix D, page D-9. Required production rates, equipment mass and power requirements are also included on the referenced page.

c. Foamed Glass

The free glass particles separated from the $< 90 \mu\text{m}$ fine fraction of lunar soil can be used almost directly for the production of SPS foamed glass structural elements.

Foamed glass is made from glass particles to which small amounts of foaming agents are added, after which the mixture is subjected to a controlled heating and annealing cycle.

Various foaming agents have been used commercially since the development of foamed glass in the early 1930's. These include such materials as water, calcium carbonate, carbon and mixtures of sodium or calcium sulfate and carbon, iron oxide and carbon and others (References 25 and 26). Carbon may be in the form of powdered anthracite coal, activated charcoal or pure carbon. Demidovich (Reference 25) provided a thorough exposition of the various processes and starting materials used in the manufacture of foamed glass in the USSR, the U. S., France, Japan and Czechoslovakia.

Foamed glass is widely used commercially as an insulation material for buildings, industrial piping, and other equipment. It has very low thermal conductivity, is moisture resistant because of its closed glass cells and is impervious to most acids. In addition, it is noncombustible, dimensionally stable, has good compression strength and can be produced in various controlled densities. The prime producer in the United States, the Pittsburgh Corning Corp., provides a low density product, trademarked Foamglas, made

to a density of 136 kg/m^3 (8.5 lbs/ft^3) which has a compressive strength of 0.7 MPa (100 psi) (Reference 27). The strength of foamed glass increases with density; at 350 kg/m^3 (21.8 lbs/ft^3) a strength of 3 MPa (435 psi) is achieved.

The composition of commercial foamed glass is generally similar to that of soda-lime window glass, except that a small amount of sulfates (possibly 0.2 - 0.3%) are added to the melt to aid in foaming. The glass is melted, crushed and ball milled, with a small amount of carbon (a few tenths of a percent by weight) added during ball milling. The ball milling reduces the glass particles to approximately $5 \mu\text{m}$ in diameter (specific surface area of $500 \text{ cm}^2/\text{gram}$). The resulting mixture is placed in stainless steel pans and heated to $700\text{-}900^\circ\text{C}$ for foaming. The carbon reduces the sulfates to CO , CO_2 , H_2O and H_2S to provide the gases for foaming the glass. After foaming, the glass is slowly cooled and annealed. Foamed glass may be readily cut and machined by standard methods and equipment, and is commercially produced in the form of block, plate or tubes. For its use in Lunar Resource Utilization, minimization or elimination of secondary machining operations is desirable.

According to Demidovich (Reference 25), foamed glass can be successfully produced from a wide variety of glasses as well as from clays, nephelines, volcanic cinders, andesites, pumice, obsidian, syenites and other naturally occurring rocks and soils, with the higher melting point minerals generally requiring higher foaming temperatures. While window glass compositions foam at $700\text{-}800^\circ\text{C}$, foamed glass made from a fusible clay foamed at $950\text{-}1050^\circ\text{C}$. A satisfactory foam glass was made from volcanic cinder from the Nal'chik area of the USSR. The composition of this cinder was 72% SiO_2 , 11.7 - 14.4% Al_2O_3 , 1% Fe_2O_3 , 1.5 - 3.4% CaO , 0.1 - 0.5% MgO , 5% K_2O and 1.5 - 3.8% Na_2O .

Based on the above, it is highly probable that foamed glass of comparable quality can be made from lunar derived glass. The glass particles separated from lunar fines can be ball milled to $5 \mu\text{m}$ diameter size or less, mixed with the small amounts (0.2 - 0.3%

by weight) of sodium sulfate and carbon necessary for foaming, and then foamed. Sufficient quantities of sodium and sulfur exist on the moon to provide the 40-60 tons of sodium sulfate required to manufacture the approximately 20,000 tons of foamed glass needed for each SPS. Sodium exists in the lunar regolith in quantities ranging from 0.2 to 0.5% while sulfur ranges from 0.06 to 0.2% by weight. A review of the processes and facilities required to separate these elements and react them into sodium sulfate is necessary to evaluate the cost effectiveness of deriving this foaming agent from lunar soil as compared to transporting it from earth. Likewise, the small amount of carbon required for foaming glass may be recovered from the lunar soil where it occurs in amounts of 80 to 150 ppm, and again the cost and effort to do this must be compared to the cost of transporting a relatively small amount of carbon from earth.

The production of foamed glass shapes lends itself to a high degree of automation. The manufacture of foamed glass can be performed either on the moon or in the SMF; however, shipping glass particles from the moon to the SMF would provide for more efficient packaging than shipping foamed glass shapes. A flow chart and sketch of equipment for producing foamed glass are shown in Figure 4-13.

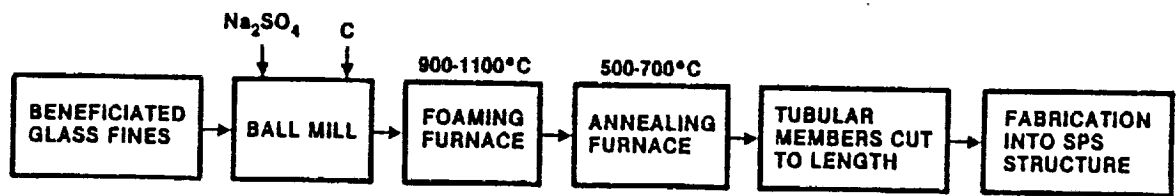
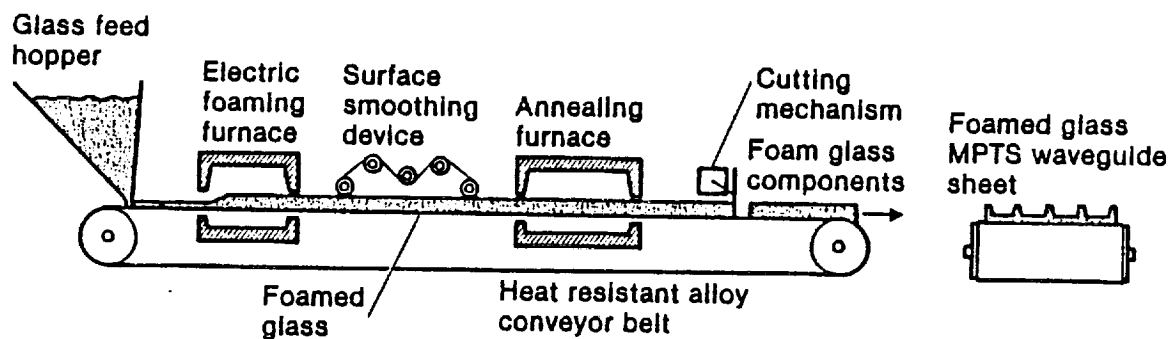

Native lunar glass employed for making foamed glass

Figure 4-13. Foamed Glass Production
Continuous Automated Process For Structural & Waveguide Components.

An experimental automated foamed glass production unit of the type shown in Figure 4-13 was designed and constructed by the Soviet State Institute of Glass and was successfully operated to produce a continuous slab of foamed glass (Reference 25). This device produced slabs 40-60 mm thick, 300-400 mm wide of virtually unlimited lengths, but, in spite of very successful pilot plant production, was not put into commercial practice.

Since the glass particles fed onto the conveyor belt will conform to the shape of the container, the production of tubular shapes will require fixing a high temperature alloy rod along the length of the foaming furnace so that the glass foams up around the rod to form a tube. The alloy rod must be extractable from the foamed glass. Some design and development effort must be devoted to the problem of direct production of long tubes of foamed glass, since the huge quantity required will not permit other than very minor secondary shaping or machining operations.

The joining of foamed glass structural elements is accomplished by the use of fusion processes such as oxy-acetylene flame, laser or electron beam welding.

Free glass particles constitute a significant proportion of the lunar soil fines (Reference 3). Sixty percent by weight of lunar soil consists of particles under 90 μm in size. The fines are very rich in glass, with individual samples varying from 10% to more than 30% by weight of glass.

Assuming the processing of 1,000,000 tons of lunar soil, with 15% of the under 90 μm particles being free glass recoverable by beneficiation, a total of 90,000 tons of fine glass particles can be obtained. This quantity is considerably in excess of the total glass requirements for the SPS, which includes 36,097 T of fused silica glass for substrates and cover plates of the photovoltaic cell arrays and 20,074 T of foamed glass structural elements.

The facility and power requirements for the production of foamed glass components are listed in Appendix D, pages D-10 and D-13.

d. Fused Silica Glass

The fused silica glass required for photovoltaic cell substrate and cover plates must be high purity material having excellent optical, ultraviolet resistance, and electrical properties. The free glass particles recovered by beneficiation of lunar soil are not suitable for these applications since they may contain large amounts of metallic and lithic impurities and would have poor optical properties.

The starting material for these applications must be silica made by the chemical recombination of silicon and oxygen derived from the electrolysis of lunar soil. Various processes for the manufacture of glass sheet are listed in Table 4-15 along with statements of their current status and anticipated problem/risk areas. Most of the current commercial glass making processes are not suitable for the production of the very thin (50-75 μm) sheet required for photovoltaic cell application. While smooth flat surfaces may be obtained by fire-polishing, the various glass rolling and drawing processes do not lend themselves to the production of extremely thin sheet in the micron thickness range.

The most feasible process for thin silica sheet production involves vapor deposition on a substrate. Electron-beam evaporation has been demonstrated by producing very thin borosilicate glass films 0.5 - 50 μm thick (Ref. 28). Mackenzie (Ref. 29) has also recommended the vapor deposition of silica to provide windows of good optical properties. The same type of electron-beam gun used for the vapor deposition of aluminum shown in Figure 4-12 can be used to prepare thin fused silica sheet. Because of the high melting temperature of silica, crucibles of magnesia (melting point 2800°C) would be used to contain the molten silica. Experimental work is required to determine the uniformity of thickness control and maximum sizes of 50 - 75 μm thick sheet which can be produced by vapor deposition. An estimate of the vapor-deposited silica sheet manufacturing equipment is contained in the LRU element data sheet shown in Appendix D, page D-21.

Table 4-15. Processes for Manufacture of Fused Silica Glass Sheet.

<u>Mfg. Process</u>	<u>Status</u>	<u>Applicable to</u>		<u>Problem/Risk Areas</u>
		<u>Moon</u>	<u>SPS</u>	
Rolling process	Current commercial process	Yes	Pseudo may be required	Not suitable for very thin glass. Requires moderately massive rolling and polishing equipment supplied from earth.
Pilkington float process	Current commercial process	Yes	Not readily applicable; requires very constant gravity free of vibration.	Requires moderately massive equipment and special tin alloy supplied from earth.
Fourcault vertical draw process	Current commercial process	Yes	Pseudo gravity required	Product suffers from waviness, drawing very thin sheet may pose serious problems.
LOF-Colburn vertical-horizontal draw process	Current commercial process	Yes	Pseudo gravity required	Relatively massive equipment required. Some drawbacks as Fourcault process.
Pennvernon vertical draw process	Current commercial process	Yes	Pseudo gravity required	Same drawbacks as Fourcault process.
Electron beam evaporation	Current commercial process	Yes	Yes	Control of thickness uniformity, separation from substrate without breakage of glass.

e. Glass Filaments

Glass filaments are made by melting glass particles in an electrically heated furnace, pouring the molten glass into a container having a large number of fine orifices through which the glass is continually drawn. The glass filaments may be gathered together into a strand and wound into multifilament threads or may be individually wound on spools. The manufacture of glass filaments is a standard, highly developed process and no problems are foreseen in transferring this process to the lunar surface or to a SMF.

Darwin Ho (Reference 30) has proposed a method of producing glass fibers from mixtures of lunar anorthite, slag and calcium oxide; the latter two derived as by products of aluminum and titanium chemical extraction from lunar soils. Ho outlined processes involving solar furnaces placed either on the moon or in a SMF for melting glass, which is then drawn through bushings containing large numbers of fine orifices to produce fiberglass.

Glass filaments will be employed as electrical insulation as well as to fabricate bags. These bags are used in LRU Concept B to transfer lunar soil with the mass driver catapult from lunar surface to the catcher at L₂. Equipment and power requirements to produce glass filaments are listed in Appendix D, pages D-10 and D-28.

f. Production and Purification of Silicon

The production of the tremendous quantity of silicon solar cells needed for a 10 GW SPS is well beyond both current and projected future earth based manufacturing capabilities in 1990. An SPS of the above power level requires approximately 100 km² of silicon solar cells. In 1975, the United States produced approximately 500 m² of silicon solar cells for space and 1000 m² for terrestrial applications (Reference 31). It has been estimated that U. S. industry will have the capability of producing 0.2 km² of silicon solar cells by 1984 and 10 km² by 1988 (Reference 32). It has also been estimated that a market for approximately 4 km² of silicon solar cells will exist in

1986 (Reference 33). None of these estimates included consideration of an SPS program.

There is no shortage of silicon; it is the second most abundant element on both earth and the moon, amounting to 27.7% and 20-22% of their crustal masses respectively. The United States has many multimillion ton deposits containing 95-99% SiO₂. In 1977 the United States consumed silicon metal, ferroalloys and other silicon compounds totalling 600,000 tons of contained silicon (Reference 34). Most of this consisted of ferrosilicon alloys used in the production of ferrosilicon. Metallurgical grade silicon metal is quite inexpensive, being priced at \$0.50 per pound or less.

High purity silicon for semiconductor devices was first made by reducing silicon tetrachloride with zinc. Other processes which were introduced later involved the pyrolytic decomposition of silane and the decomposition of silicon tetrachloride. Current production practices generally involve the hydrogen reduction of silicon tetrachloride (SiCl₄) or trichlorosilane (SiHCl₃). Semiconductor grade silicon is considerably more expensive than the metallurgical grade, selling for \$25 or more per pound.

If lunar derived silicon is to be used in the manufacture of SPS solar cell arrays, the silicon recovered from the electrolysis of lunar soil must be purified to a $<10^{-9}$ impurity content. This can be done in a variety of ways, all of which require the use of earth supplied chemicals such as hydrochloric or hydrofluoric acids, sodium chloride, etc. Since the silicon purification processes will generally permit recovery and recycling of most of the earth supplied chemicals, the quantity of such chemicals as well as their make-up supply to be furnished from earth may be kept to reasonably low amounts.

One process for purifying silicon involves the pyrolysis of silane produced by the decomposition of dichlorosilane. The latter is produced from higher chlorosilanes

resulting from the reaction of impure silicon with hydrogen and silicon tetrachloride in a copper catalyzed fluid bed reactor. Another process involves the sodium reduction of silicon tetrachloride in an arc heater. Yet another process involves the decomposition of polymerized silicon difluoride. The selection of a specific silicon purification process depends upon the mass of earth supplied chemicals and process equipment and power requirements. Appendix D, pages D-23 and D-24 outline the facility and power requirements for the production of the 14,775 tons of purified silicon required for each SPS.

The combination of a silicon purification process with vapor deposition may permit the production of high purity silicon sheet which can be directly fabricated into solar cell components. In this connection the silicon halide-alkali metal flame process with CVD of the resulting silicon may be of interest. Silicon solar cells may by this method have, however, demonstrated low efficiencies up to now.

Conversion of silicon into ingots in Czochralski crystal pulling furnaces and slicing them into solar cell wafers is not considered a desirable way to manufacture the huge quantity of solar cells required for an SPS, even though this method is presently used to manufacture all spacecraft solar cells. Wafer sawing and etching to remove surface damage result in 50-70% material losses.

Both NASA and DOE are currently funding major research and development programs whose objectives include preparation of low cost semiconductor grade silicon, low cost solar cell manufacturing processes, and low cost automated processes for the production of large solar cell arrays. Major breakthroughs remain to be achieved to realize the above goals; however, it now appears feasible to produce high purity silicon at a cost of \$5-8/kg (\$2.25-3.50/lb) in quantities of 1000-5000 T/year (Reference 35). The need for even lower cost semiconductor grade silicon and the magnitude of the development effort which must be made is emphasized by the requirement for approximately 15,000 tons of silicon for the solar cells of each SPS.

4.4.5 MANUFACTURE OF PARTS

Details regarding the required annual production rates and quantities of SPS parts, as well as facility requirements including weights and power are contained in Appendix D, Pages D-11 through D-16 of Volume III. These pages also include descriptions of the various production processes to be used in the manufacture of SPS parts.

The following section includes discussions of a number of alternative materials and parts production processes in addition to those included in Appendix D.

a. Electrical Insulation

Conventional electrical insulation materials; i. e., plastics, rubbers, papers, etc., cannot be derived from lunar materials because of their organic nature. Their use would necessitate their transport from earth. Most of the conventional organic insulation materials would, in any case, be unsuitable for use in space because of volatile losses in high vacuum, embrittlement at low temperatures, and degradation under long-term ultraviolet irradiation.

Other types of electrical insulation materials can, however, be developed from lunar sources. One such material is fiberglass which is currently being used in electrical insulation applications, and this is the material which has been selected for the basic SPS electrical wire insulation. Page D-16 of Appendix D describes the braiding process currently used for applying glass fiber insulation to electrical wiring and defines the facility and power requirements to produce the required amount of insulated wire.

Another type of insulation material derivable from lunar sources consists of rigid ceramic or glass insulation components. The free glass particles separate by electrostatic beneficiation of the fine fraction of lunar soil can be ground and sintered or melted and cast into a variety of shapes needed for electrical insulation applications. These shapes can include threaded components, slotted bodies for mounting parallel aluminum wires, etc.

A third type of insulation material which can be produced from lunar sources consists of powdered magnesium oxide which is packed around the conducting wire and contained within a tubular metal sheath. The outer metal tube can be fabricated from thin aluminum strips that are roll-formed and welded. The powdered magnesium oxide can be produced by reacting metallic magnesium with oxygen; both having been produced by the electrolysis of lunar soil.

b. Klystron Housing

The Boeing SPS study defined the various parts and provided schematic sketches of their construction. The klystron housing was described as being fabricated from 3.2mm thick steel, which was replaced in the LRU study by aluminum or aluminum alloy sheet. However, at the mid-term briefing on Contract NAS8-32925, "Extraterrestrial Processing and Manufacturing of Large Space Systems," held at MIT on 30 January 1979, it was stated that a Raytheon Company review of the Boeing design showed that the klystron housing was too thin. Electrical noise problems would require the housing to be significantly thicker, making a cast part more practicable than one fabricated from plate material.

Making this component as a casting would require an increased amount of aluminum, but since only approximately 400 tons of aluminum sheet are presently required annually for both the solenoid and collector housings, increasing this quantity by a factor of 5 increases the total requirement for lunar derived aluminum by only 15%. This will not appreciably alter the results of the current study.

4.4.6 COMPONENT ASSEMBLY

Appendix D of Volume III lists a total of 27 items covering materials stock production, parts manufacture and components assembly. All of the first 26 items listed on Pages D-4 through D-27 are pertinent to each of the three LRU options. A 27th facility requirement, outlined on Page D-28, needed for the manufacture of fiberglass bags for mass driver payload packaging, has been defined for LRU Concept B and its peculiar to this concept only. Source reference information is listed on each manufacturing data sheet.

Information on production processes and rates, facility and power requirements and other production data associated with SPS components assembly are contained in Pages D-17 through D-27 of Appendix D. All data sheets pertinent to silicon refinement, silicon wafer production, silica glass solar cell substrates and coverplates, preparation of solar cell conducting circuits and other processing of silicon solar cells and solar cell panel assembly are grouped together on Pages D-21 through D-27. These were so grouped for a number of reasons. One is that the manufacture of solar cell arrays comprise a major element of SPS production. Solar cell manufacturing is also beset by the most technically challenging problems associated with the SPS concept, since it involves the largest facility mass, most complex accumulation of production equipment, and requires an order of magnitude more power than all the other facilities required to produce the lunar derived materials stocks and manufacture SPS detail parts and components.

The cost of high purity semiconductor grade silicon represents but a small part of the cost of completed solar cell arrays. Modules of encapsulated interconnected solar cell wafers presently cost in the range of \$700 per square meter. The modules may consist of arrays of 50 μm thick wafers of silicon interconnected with silverplated copper strips formed on substrates of borosilicate or fused silica glass bonded to the silicon wafers. Cover sheets of 75 μm borosilicate or fused silica glass are bonded to the front faces of the wafers. The thin silicon wafers are saw cut from ingots, polished and doped to develop the n and p faces.

The development of low-cost, high-speed, highly automated production of large solar cell arrays is essential to an SPS program regardless of whether the manufacture is done on earth, on the moon, or in space. Since this is not yet achievable on earth, the solution to this problem is of paramount importance to the SPS.

The "edge-defined film growth" (EFG) method developed by Mobil Tyco Solar Energy Corporation has been developed to the point where a multiple ribbon growth machine

can produce five 5-cm wide ribbons at a growth rate of 3 cm/min. A 100-unit facility consisting of twin 5-ribbon machines producing 7.5 cm wide ribbons at a rate of 7.5 cm/min could produce $2.9 \times 10^6 \text{ m}^2$ of silicon solar cell ribbon. While this production level may constitute 25% of the anticipated solar cell market in 1988, it still falls far short of the approximately $100 \times 10^6 \text{ m}^2$ required for an SPS. At the present time, EFG silicon ribbons are approximately $100 \mu\text{m}$ thick and require etching of both surfaces to reduce their thickness. It is expected that continued technological development over the next decade or two will permit the growth of thin ribbons requiring little or no surface etching to produce acceptable solar cells.

Motorola, Inc., has developed a ribbon-to-ribbon (RTR) crystal growth process using CVD and trichlorosilane as the source gas for the polycrystalline feedstock. A future process uses plasma deposition and silane as the source gas. Other techniques for producing ribbon silicon include web dendrite and horizontal ribbon growth. In addition to these attempts to mass produce silicon ribbon and sheet, the Czochralski crystal growing process and wafer sawing and cutting processes are being improved to reduce cost and material losses. Larger crystal growing furnaces and the growth of multiple ingots from the same container are also being achieved. Nevertheless, considerably more progress is needed to meet SPS requirements.

Solar cell wafers or ribbon must then be doped to provide n and p surfaces, metallized to develop conductive paths, bonded to glass substrates and coated or covered to provide radiation shielding. The surface of the silicon may be texture-etched to optimize light absorption or may be provided with an antireflection coating. There are numerous process steps in fabricating solar cell arrays, some of which may be labor intensive and involve considerable handling.

Ion implantation to develop shallow junctions in solar cells has shown considerable promise, and a machine has been designed that could implant silicon wafers or ribbon at a rate of $180 \text{ m}^2/\text{hr}$ (Reference 36). High-speed annealing after doping may be performed by electron beam or laser pulsing, with resulting epitaxial grain growth.

Current methods of electroplating and solder dipping to develop conductive paths and interconnectors involve numerous immersion, rinsing, scrubbing, plating and drying operations. Soldering causes problems because of oxide layers on top of the molten baths. Many of these problems would be reduced or eliminated by performing these operations in the high vacuua that prevail on the moon or in a SMF. Since aluminum wire and wire mesh can be produced from lunar materials these should be considered for use in solar cell manufacture in place of electroless nickel and precious metal plating. Electron beam evaporation and deposition techniques are also applicable for the preparation of the internal circuits in solar cell assemblies. Electrostatic bonding may replace adhesive bonding in assembling solar cell coverplates and substrates. Silicon can also be produced in amorphous thin films by vapor deposition, using the same type of electron beam guns described for aluminum and iron deposition. While amorphous silicon solar cells made to date have shown low efficiencies, continued development may result in improvement, particularly if epitaxial growth could be stimulated by means of electron beam or laser pulsing.

In summary, it may be concluded that the production of silicon solar cells is a prime determinant in the success of the SPS program. Major breakthroughs in manufacturing technology are required to efficiently produce the huge quantity of solar cells required. Once this capability is established, production of solar cells in a SMF using lunar-derived silicon will be feasible. The high vacuum and clean environment in space could positively contribute to the production of high quality silicon solar cells and minimize defects.

The following processes have been selected for the production of solar cell quality silicon and the production of solar cell panels. Silicon of solar cell quality will be prepared from metallurgical grade silicon by the silane purification process. The purified silicon will then be prepared in the form of 7.7 cm wide ribbon, 50 μm thick, by the EFG ribbon growing process, using 4283 double furnace units. Currently, EFG ribbon is produced 100 μm in thickness, and must be etched in a sodium hydroxide solution down

to the desired 50 μm thickness. It is anticipated that this process will be developed during the next 15-20 years to the point where 50 μm silicon ribbon can be produced directly without requiring an etching step.

The silicon, after being cut to length, is fed through an automated facility which implants dopants front and back, pulse anneals the implaced silicon wafers, assembles the solar cell modules and electrostatically bonds the silica substrate and cover sheets. The aluminum interconnections and contracts are vapor deposited on the glass substrate and silicon wafers prior to assembly in the modules.

A facility to perform most of the above steps is currently under development by SPIRE Corporation and is depicted in Figure 4-14.

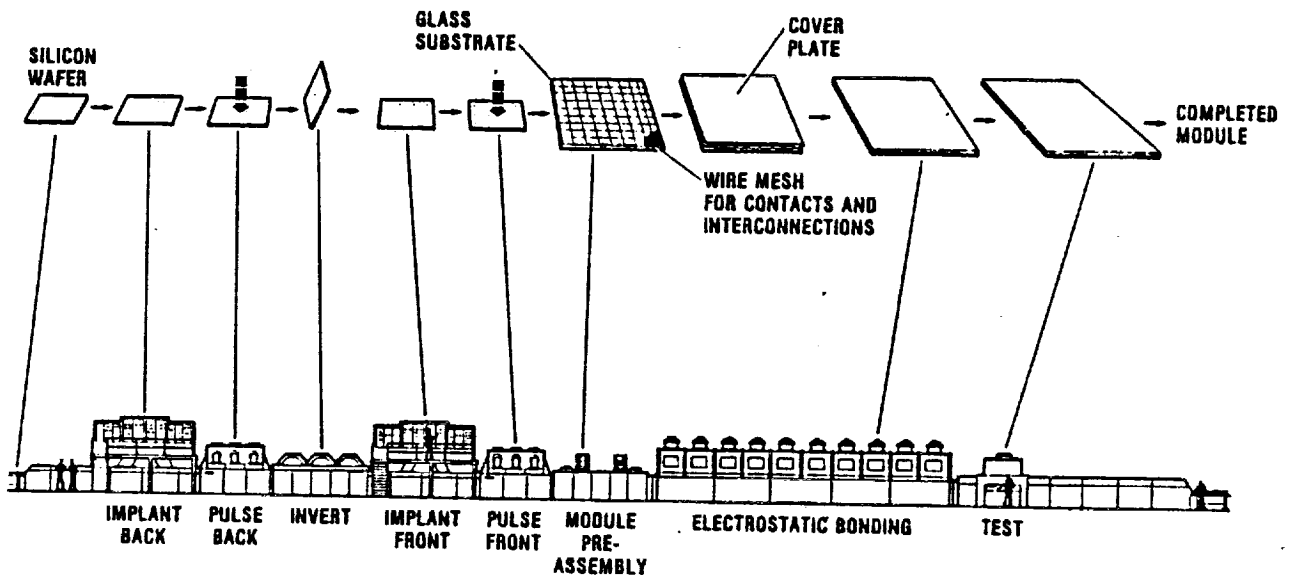

- Each module contains 252 solar cells
- A 10 GW SPS requires 78,388,736 modules
- Construction of one SPS per year requires 2.5 modules per sec
- 83 of production lines shown required

Figure 4-14. Solar Cell Module Production.
Automated Process Courtesy of SPIRE Corporation.

Listings of the facility and power requirements to manufacture lunar-derived materials stock, parts, component assemblies and solar cell panels are included on Pages D-29 through D-32 of Appendix D.

The facility mass and power estimates used in the previously described data sheets for the basic manufacturing equipment (electron beam vapor deposition guns, casting machines, furnaces, etc.) have been based on data for similar earth production equipment. For in-space or lunar surface use, the mass and perhaps power consumption associated with these facilities can be reduced considerably. However, a significant quantity of peripheral equipment and tooling is required to support each major manufacturing function. Application of the full earth mass to similar facilities designed for in-space use should adequately account for these undefined peripherals.

Repetitive handling operations between manufacturing steps and most assembly operations were assumed to be performed by industrial robots. Industrial robot quantities identified in Appendix D are based on assumed material handling and feed requirements for highly automated production equipment.

A summary of the total facility mass and power requirements is given in Table 4-16. This dramatically shows that the manufacture of silicon solar cell panels accounts for more than 90% of both items.

4.4.7 MATERIALS LOSSES DURING PROCESSING AND MANUFACTURE

Material quantities previously used for development of lunar resources utilization scenarios and facility sizing requirements were nominal estimates obtained from the results of Task 5.2, "Material Requirements." These material quantities were presented in Table 3-18 and are repeated here in Table 4-17. The nominal quantities shown include a 26.6% margin based on SPS uncertainty analysis, but contain no provision for material losses which occur during LRU processing and manufacturing operations.

Table 4-16. SMF Mass and Power Requirements
For Stock Production and Manufacture of SPS Parts and Assemblies.

Item	Mass (tons)	Power (MW)
Stock Production: Aluminum sheet, wire & castings; steel sheet & plate; alloy castings, glass filaments	173	20.5
Parts Mfg: Aluminum fittings, Klystron housings & electroplated cavities; foamed glass tubes & waveguides; steel heat pipes, fiberglass elec insulation, fiberglass bags	1308	3.9
Component Assy: DC-DC converters, Klystrons, radiators, structural members, waveguide subarrays	185	0.41
Solar Cell Panels: Silica glass substrates & covers, purified silicon, Si ribbon, doping, apply contacts, processing solar cells & solar cell module assembly	22,050	258.4
Total —	23,716	283.21
% Required for solar cell panels —	93.0	91.2

Manufacturing Material Requirements

Estimates have been made of the nonrecoverable losses of both lunar and earth supplied materials occurring in the various stages of converting metallic and nonmetallic elements into stock materials, parts, components and subassemblies for the SPS.

The nonrecoverable losses of lunar materials at all stages of production are low; in the range of 0.1 to 0.2% since any scrap material can readily be recovered by re-processing. However, the nonrecoverable losses of many lunar and earth supplied alloying elements may be much higher, in the order of 5-10%, since it will not generally be worth the effort and expenditure of energy to recover them from scrapped foamed glass, metallic alloys, etc.

Table 4-17. Lunar and Earth Material Requirements Summary;
Nonrecoverable Manufacturing Losses not Considered.

		MAX LUNAR UTILIZATION ALL CATEGORIES	
		MASS (T)	% OF TOTAL
Lunar material requirements	Silicon	31,649	32.2
	Natural Glass	20,093	20.4
	Oxygen	19,223	19.5
	Aluminum	11,925	12.1
	Iron	5,300	5.4
Total lunar material		88,190	89.6
Earth material requirements	Metals	2,316	2.4
	Graphite	0	0
	composite Various	7,874	8.0
Total earth material		10,190	10.4
Total SPS mass (T)		98,380	—
Percent of earth baseline SPS mass		100.9	

Tables D-6 through D-10 on Pages D-34 through D-38 of Appendix D in Volume III list the nominal and total quantities of SPS requirements, starting from the complex assemblies and working back toward the stock materials required to fabricate the parts and components going into assemblies. The total amount of material required for the construction of an SPS, considering all of the unrecoverable losses, is obtained from the above pages and is summarized in Table 4-18.

The following assumptions have been made in deriving the material quantities shown in Table 4-18. Native glass is used for the production of the foamed glass structural elements, the MPTS waveguides and fiberglass electrical insulation. The metallurgical grade silicon is used as follows:

1. 17,755 tons are converted to 15,092 tons of solar cell grade silicon by the silane process with 85% efficiency.
2. 16,948 tons are reacted with 19,350 tons of oxygen to produce 36,281 tons of silica glass for substrates and cover plates of solar cells.
3. 126 tons are used as an alloy constituent in the sendust transformer core castings. These are made from an alloy of 85% iron, 10% silicon, and 5% aluminum.

Table 4-18. Summary of SPS Material Requirements
Including Nonrecoverable Losses.

<u>Lunar Derived Materials</u>	<u>Tons</u>
Native Glass	34,685
Metallurgical Grade Silicon	34,829
Aluminum	12,275
Iron	4,460
Oxygen	19,369
Alloying Elements	<u>33</u>
TOTAL	105,651
 <u>Earth Derived Materials</u>	
Alloying Elements, Plastics, Etc.	<u>12,491</u>
GRAND TOTAL	118,142

Aluminum and aluminum alloys in the form of sheet are used in many applications; for end fittings on foamed glass structural elements, radiators, piping, klystron housings and electrical conductors. They are also employed in the form of castings for klystron cavities, nodes for structural element connectors and as a constituent of the sendust transformer core castings. Aluminum wire is required for many electrical applications, and vapor deposited aluminum is used in waveguides and as electrical contacts in solar cell panels.

Iron is used as a major constituent of sendust castings, as klystron solenoid poles and in the stainless steel alloy heat pipes. Small amounts of lunar-derived silicon and magnesium are employed as alloying elements.

Comparison of the material requirements data in Table 4-17 and 4-18 shows an increase of 19.8% in lunar material requirements, and an increase of 22.6% in earth material requirements. Although unrecoverable materials are responsible for some of this increase, revised foamed glass requirements and other material quantity changes in the completed LRU solar power satellite are major contributors. The updated SPS mass for construction with lunar materials is 112,223 T, with 101,922 T manufactured from lunar material and 10,301 T obtained from earth. This revised SPS mass estimate for construction with lunar materials is shown in Table 4-19.

Table 4-19. Revised SPS Mass Estimate for Construction With Lunar Materials.

	<u>Total</u>	<u>Mass (Tons)</u>	
		<u>Lunar</u>	<u>Earth</u>
Photovoltaic blankets	54,880	51,570	3,310
Primary structure } secondary structure }	28,001	27,643	358
Sheet conductors and } cable and wire conductors }	4,041	4,041	0
Klystron module	20,966	15,508	5,458
DC-DC Converter	<u>4,335</u>	<u>3,160</u>	<u>1,175</u>
	112,223	101,922	10,301
		90.8%	9.2%

Lunar Material Requirements

Estimates have also been made of the efficiency of element recovery from lunar soil. The recovery of each element was arbitrarily taken as 50% for silicon, oxygen, aluminum and iron. This value was chosen because of the known resistance to electroreduction of SiO₂, the major oxide constituent of lunar regolith.

As the basis for estimating the amounts of lunar soil to be processed, the composition of the lunar highlands regolith was assumed to be the following (Reference 37):

oxygen	- 44.6%	aluminum	- 13.3%
silicon	- 21.0%	iron	- 4.9%

It was further assumed that the lunar soil consists of approximately 40% by weight of fine particles up to 90 μm in size of which 30% consists of glass in both free form and as a constituent of agglutinates.

Table 4-20 contains an estimate of the total quantity of lunar soil which must be processed to supply the materials required for SPS production. The primary SPS constituents obtained from lunar soil are native glass and metallurgical grade silicon as indicated by Table 4-18.

Table 4-20. Stock Material Requirements for SPS
Obtained from Lunar Resources.

Product or Component	Nominal * Quantity (T/Yr)	Origin: Lunar (L), Earth (E)	Unrecoverable Loss Factor (Percent)	Total Quantity (T/Yr)
Native glass	34,685	Lunar soil (L)	0.108 (Note 1)	321,157
Metallurgical grade silicon	34,829	Lunar soil (L)	.50	331,705
Aluminum	12,275	Lunar soil (L)	.50	184,586
Iron	4,460	Lunar soil (L)	.50	182,041
Oxygen	19,369	Lunar soil (L)	.50	86,857

NOTE 1: Particle < 90 μm in size constitute ~40% by weight of the lunar regolith. It is estimated that 30% of this fine fraction is glass, either in free-form or as a constituent of agglutinates. After ball milling to < 5 μm particle size, glass is 90% recoverable by electrostatic beneficiation.

Constitution of lunar highland soil:

Silicon	21.0%
Aluminum	13.3%
Iron	4.9%
Oxygen	44.6%

In the case of lunar-driven glass required for the production of foamed glass structural element and MPTS waveguides, it is estimated that electrostatic beneficiation would readily permit a 90% recovery of lunar glass after the less-than-90 μm -size fraction of lunar soil is ball-milled to under 5 μm particle size.

As indicated in Table 4-20, the extraction of 34,685 tons of native glass from 321,157 tons of lunar soil leaves a remainder of 286,472 tons from which various other materials can be extracted. Metallurgical grade silicon requires the processing of more lunar soil than any of the other materials required for the SPS; a total of 331,705 tons. With the 286,472 tons remaining after removal of glass, an additional 45,233 tons of lunar soil

must be mined for the extraction of silicon, making a total of 366,390 tons of lunar soil to be processed.

The above estimates are based on the premise that the chemical composition of lunar glass is similar to that of the lithic components. This may not be strictly true since lunar glasses have been found to have widely varying compositions, some much higher in silica and others higher in magnesia than the average lithic constituents (Reference 3). The very high silica glasses, however, are reported to be rare, consisting of <1% by weight of material.

The lunar soil requirements shown in Table 4-20 have been calculated based on SPS material requirements, and do not include consideration of transfer vehicle propellant requirements (oxygen and perhaps aluminum) which must also be derived from lunar soil. As explained in Section 4, the originally estimated total lunar material requirement for LRU systems Concept B (348,200 T) was dependent on silicon requirements, and sufficient additional oxygen was available to satisfy propellant needs. The revised mining requirement of 366,390 T corresponds to a 5.2% increase over that previously identified for Concept B. A similar modest increase in the previously reported mined material needs for LRU Concepts C and D also results (See Section 4.7).

4.4.8 EARTH MATERIALS REQUIREMENTS

The assumption is made that all water and gases other than oxygen required in the production of lunar materials, stock forms, SPS parts and components will be supplied from earth. This may not be completely true, since more detailed exploration of the moon may disclose concentrated sources of water, ice and other trapped volatiles (Reference 38). Hydrogen, water, helium, nitrogen, methane, CO and CO₂ are released upon crushing or heating of lunar soils and rocks (Reference 3), with several of the elemental constituents present in amounts as high as 100 parts-per-million. Solar heating and melting of lunar soil in a confined volume may well permit the collection and separation of volatile constituents, but this has not been considered in this study.

Earth materials are required for space processing in addition to various earth manufactured components which are directly assembled into SPS components and fabricated elements. Previous efforts to define manufacturing facility requirements concentrated on the equipment needed and these estimates did not include an allowance for the heat transfer loop which removes process heat at the source and transfers this energy to the space radiator loop for dissipation, or chemicals needed for other processing operations. Tables 4-21, 4-22, and 4-23 identify these material requirements which must be satisfied using earth resources. Process heat removal can be accomplished with coldplate conductors, air, water, and other fluids and gasses. Specific emphasis has been placed on defining requirements for water, since most earth manufacturing operations utilize large quantities of H₂O for cooling, washing, and other purposes.

The cooling water requirements, Table 4-21, for stock and parts manufacturing and component assembly were estimated based on the following assumptions: (1) the cooling water is circulated through the manufacturing equipment and into a heat exchanger where it is cooled by a fluid circulating through the space radiators, (2) the equipment cooling water will have a ΔT of 70°C; inlet temperature of 10°C, and outlet temperature of 80°C, (3) the cooling water circulation cycle takes one-half hour from equipment to heat exchanger and back to the manufacturing equipment, (4) the heat exchanger efficiency is 75%.

The thermal efficiencies of the various materials and parts manufacturing and assembly processes were estimated; in some cases based on current processes or scale-up of laboratory processes. Cooling water requirements amount to 555 tons, almost 65% of which is required in the purification of silicon to solar cell quality, growing silicon solar cell ribbon material and processing it to the point where it is ready to be assembled into solar cell modules. The requirements of water for use in manufacturing sand castings, for electroplating and for the production of foamed glass components are also listed in Table 4-21. Water is essential to the ball milling and foaming of foamed glass, and approximately 0.5% by weight remains chemically bonded in the foamed glass.

Table 4-21. Cooling Water Requirements.

Item #	Material or Process	Estimated Process Efficiency %	Cooling Water Requirement - Metric Tons
1	Aluminum Sheet production	70	21.6
2	Aluminum Wire production	60	0.1
3	Steel Sheet production	70	23.6
4	Iron Sheet for klystron solenoid	70	3.0
5	Aluminum Castings - klystron cavity	50	0.52
6	Sendust castings	50	3.07, Note #1
7	Glass filaments	50	0.03
8	Alum. End Fittings - parts mfg	50	0.15
9	Alum. klystron housings - parts mfg	50	0.32
10	Cu plate Al klystron cavity	-	-, Note #2
11	Foamed glass components	40	9.83, Note #3
12	Al deposition on MPTS waveguides	70	1.77
13	Steel heat pipes, parts mfg	60	0.35
14	Glass fiber electrical insulation	50	1.7
15	DC-DC Converter	60	0.1
16	Klystron assembly	60	0.59
17	DC-DC Converter radiator assy	60	0.08
18	Klystron radiator	60	0.1
19	Structural member assy	60	0.38
20	MPTS Waveguide Subarray Assy	60	0.1
21	Silica glass - covers & substrates	50	74.4
22	Al deposition on solar cell substate	70	2.95
23	Si refining to PPB level	70	47.56
24	Silicon solar cells, EFG process	80	236.76
25	Cut EFG ribbon, dope, contacts, anneal	80	75.51
26	Solar cell module assy	80	47.54
27	Fiberglass bags - make glass & fab bags	50	3.14
Total cooling water requirement			555.25 tons

Note #1 - Sand molds for sendust casting require annual supply of 4.5 tons of water to temper molding sand.

Note #2 - Cu plating requires 27 tons of water for plating and rinsing baths and 2.7 tons annual resupply.

Note #3 - Foamed glass production requires an initial supply of 400 tons of water, and an annual resupply of 219 tons of water, 202 tons of sodium sulfate and 189 tons of carbon.

Requirements for other process fluids are listed in Table 4-22. The requirements for hydrogen (2.5T) and hydrochloric acid (265T) to produce purified silicon by the silane process are predicated upon essentially complete recovery and recycling of the reactants three times per day. A slower rate will require correspondingly more of these materials. A small quantity of helium (1.5T) is employed as a heat transfer medium during silicon ribbon growth by the EFG process. In addition to working fluids, the silane process for silicon purification will require approximately 0.1 ton of earth supplied copper to serve as a catalyst during the reaction between metallurgical grade silicon, hydrogen and silicon tetrachloride in a fluidized bed reactor.

Table 4-22. Material Requirements Other Than Water.

Process	Fluid	Quantity Tons	Use of Fluid
Growing silicon ribbon by EFG Process	Helium	1.5	Heat transfer medium during ribbon growth
Silane process for purification of silicon from metallurgical grade	Hydrogen	2.5	For reaction with metallurgical grade silicon and SiCl_4 to produce HSiCl_3
" " "	Hydrochloric acid	275	For reaction with metallurgical grade silicon to produce SiCl_4

Requirements for Materials Other Than Fluids

Miscellaneous earth-supplied materials other than fluids will be required for a number of the materials and parts manufacturing and assembly operations. Table 4-23 lists those which have been identified.

Total Earth Materials Requirements

The total earth supplied materials are summarized in Table 4-24. The bulk of them consist of electrical components and special metal and plastic parts made largely of materials that are essentially unavailable on the moon or else require fabrication facilities impracticable to send to the moon or the SMF.

Table 4-23. Requirements for Materials Other Than Fluids.

Material	Quantity Tons/Year	Use
Copper	90	Electroplating klystron cavities and catalyst for silane silicon purification process
Brazing alloys	33.2	Brazing steel heat pipes to aluminum radiator
Brazing flux	60	" " " " " "
Sodium sulfate	202	Foaming agent for foamed glass
Carbon	189	" " " " " "
Silane plastic	45	Surface coating for fiberglass filaments
Phosphorus, Arsenic or boron	0.1	Dopants for silicon solar cells

Table 4-24. Earth Material Requirements for SPS Production.

Material Requirement	Initial (T)	Annual (T)
Various SPS components - plastics, electronics & metal parts	12,934	10,347
Special metal parts & coatings	1,305.2	1,305.2
Water for SMF cooling	555.2	55.5
Water for production of materials	431.5	226.2
Hydrochloric acid for silicon refining	275	91.5
Sodium sulfate for foamed glass	207	202
Carbon for foamed glass	189	189
Other	144.1	74.6
Total	16,036	12,491

4.5 LRU INFRASTRUCTURE ELEMENT DEFINITION

Lunar Resource Utilization concept support elements such as lunar and space bases are responsible for a significant percentage of every LRU concept's development, start-up (transportation) and operating costs. This task identifies the infra-structure requirements for alternative LRU concepts, selects design concepts, and determines their costs. Fortunately, conceptual designs and cost data already exist for most of the infrastructure elements needed. This existing information will be selectively employed, along with some new data developed as part of this study, to define the required infrastructure elements. Cost data is in Section 5.

The best all-encompassing definition of infrastructure is obtained by exclusion; i.e., infrastructure includes every lunar surface or in-space element that is not part of the material processing/fabrication system or the transportation system. The major elements required for lunar resource utilization are listed in Figure 4-15 under three headings: propellant depots, habitats, and other support equipment.

Obviously a great many implementation options exist for each major element. Most of these infrastructures have been studied extensively by NASA and their major aerospace contractors. The following subsections address each element grouping presented in Figure 4-15 to identify those representative infrastructure elements which have been selected/defined for the purposes of this study.

4.5.1 Propellant Depots - These facilities are probably required at every LRU systems concept logistic center where cargo and/or personnel must be transferred to a different transportation vehicle. For the earth baseline (Systems Concept A) the only depot requirement is at LEO, although the addition of a small GEO depot for POTV return trip propellant supply might be beneficial. The lunar resource utilization options all require LH_2/LO_2 propellant supplies for POTV refueling at LEO, LLO, and the space construction facility. These POTV resupply depots will be similar, except storage requirements will vary as a function of location and system concept.

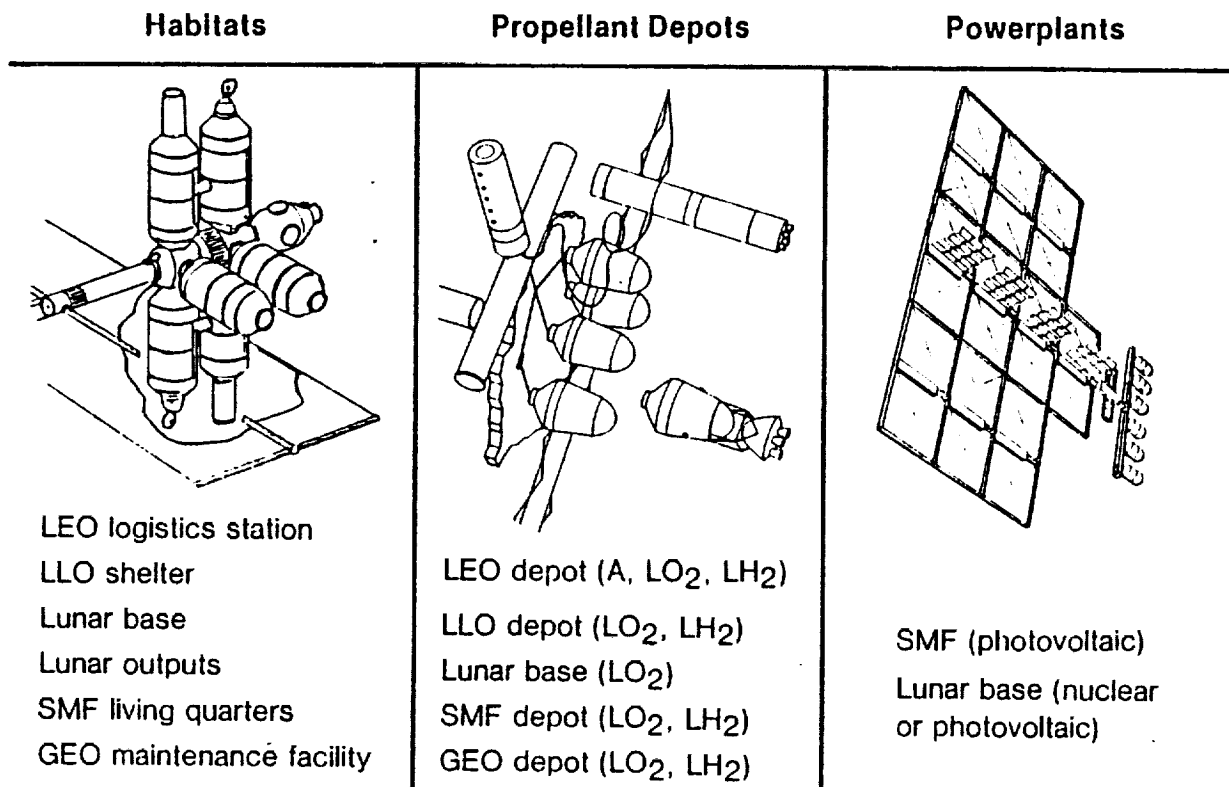

Figure 4-15. Infrastructure Elements.

The propellant requirements for COTV's and LTV's are extremely dependent on systems concept vehicle designs, the lunar material processing location, and unique depot locations. Concepts A through D all employ an ion electric COTV. For the earth baseline COTV, liquid argon is used as propellant. Argon could also be used as COTV propellant in LRU Concepts B, C and D, but a more suitable propellant may be oxygen, which can be obtained from lunar resources.

Transportation options originally considered for systems Concept B had unique propellant requirements due to the mass driver reaction engine (MDRE) and mass catcher rotary pellet launcher (RPL). MDRE and RPL propellant can theoretically consist of almost any excess mass which is convenient to the depot location. Suggestions for MDRE propellant include ground-up external tanks in LEO, lunar soil at L₂, and processing slag at the SMF. An alternative for MDRE use at all these locations is lunar derived oxygen. Oxygen is

potentially superior since it evaporates into a harmless gas after ejection, rather than remaining solid and constituting a potential hazard as do the other candidate materials. The mass catcher's RPL could use fused lunar soil, processing slag manufactured into pellets by sintering (heat and pressure), or use solid oxygen pellets. Selection of the ion electric COTV instead of MDRE/RPL deleted this unique propellant requirement.

Lunar Transfer Vehicles (LTV) must be chemically propelled to generate sufficient thrust to counteract lunar gravity. All systems concepts except D utilize LH_2/LO_2 propelled LTV's for personnel transfer between LLO and the lunar surface. Depot requirements depend on the degree of lunar surface material processing activities. If surface processing is performed (concepts C and D), an oxygen depot is needed at the lunar base. Concept B has no (or very limited) lunar processing, and consequently no surface depot requirement. Cargo transfer from the lunar surface also exhibits concept dependent propellant depot needs. Concept B employs the mass driver catapult which uses electrical energy (no reaction mass). Concept C uses conventional LH_2/LO_2 cargo rockets which obtain fuel from the LLO depot. Concept D uses a chemical rocket fuel derived from lunar materials which must be produced and stored on the lunar surface. This fuel may consist of either finely ground metals (Al, Ca, Fe, Mg, Ti), or cast grains of these same materials plus perhaps some earth-exported or lunar-derived binder. Initial work has concluded that powdered aluminum is probably the best choice.

These depot propellant storage considerations are summarized by location and systems concept in Table 4-25.

LEO Depot Definition, LH_2/LO_2 Propellants

Propellant depot sizing is dependent on both the payload capability of propellant delivery vehicles and the refueling requirements of user vehicles. Unfortunately, all the orbital transfer vehicles, both cargo and personnel, have stage and fleet sizing requirements which depend on the LRU material requirements threshold, which is not yet known. One vehicle which can be used as a depot sizing starting point, however, is the earth launch vehicle employed to deliver cargo into low earth orbit.

Table 4-25. Depot Propellants.

PROPELLANT DEPOT LOCATION	PROPELLANTS REQUIRED — SYSTEMS CONCEPT			
	A	B	C	D
LEO	LH ₂ /LO ₂ Argon	LH ₂ /LO ₂	LH ₂ /LO ₂	LH ₂ /LO ₂
LLO		LH ₂ /LO ₂	LH ₂ /LO ₂	LH ₂ /LO ₂
Lunar base			LO ₂	A/LO ₂
SMF		LH ₂ /LO ₂	LH ₂ /LO ₂	LH ₂ /LO ₂
		May be combined		
GEO		LH ₂ /LO ₂	LH ₂ /LO ₂	LH ₂ /LO ₂

The earth baseline Concept A, uses 391 HLLV flights per year to supply materials for a steady state production rate of one 10 GW SPS per year. This corresponds to an earth launched payload of 454 T/day. The various LRU systems concepts evaluated (see Section 4.2), indicate that earth material requirements for any of these concepts are only 10 to 20 percent of the earth baseline at the recommended 90% lunar resource utilization level. At 20 percent EMR, only 91 T/day are needed from earth to construct one 10 GW SPS per year. The launch system which best satisfies this payload capability, allows growth for higher material thresholds (more than one SPS/year), and has a fully reusable booster to reduce launch costs is the Shuttle

derived vehicle (SDV). The cargo version of SDV has a payload capability of approximately 200 T, requiring only one launch every two days to meet the 1 SPS/year requirement. This vehicle will be used for LEO propellant depot sizing.

Initially, all propellant for establishing the required space and lunar facilities must be delivered from earth using the SDV cargo version. After these facilities are emplaced and operating it may be feasible and cost effective to obtain all the oxygen required for in space operations from the moon. If this occurs, only hydrogen propellant will be subsequently required from earth. Thus the propellant supply modules used for the LEO depot must be compatible with SDV payload capability and have the flexibility required to initially supply POTV LH₂/LO₂ and COTV argon (or oxygen), followed exclusively by LH₂ to be used as POTV fuel. The best method of accomplishing this is via independent SDV delivery of LH₂ and LO₂ (or argon). Preliminary mass estimates of independent propellant delivery modules are contained in Table 4-26. The hydrogen delivery module configuration was dimensionally constrained for equivalence with the Shuttle external LH₂ tank, for which tooling exists. This results in an additional payload capability of 62 T which can be accommodated within the nose fairing along with each LH₂ delivery module.

Table 4-26. SDV Launched Propellant Delivery Modules.

Characteristic	Propellant		
	LO ₂	LA	LH ₂
Tank Volume (m ³)	175	143	1,523
Tank Diameter (m)	4.4	4.4	8.4
Tank Length (m)	12.5	10.4	29.4
Tank Mass (T)	2.6	2.6	22.1
Fairing & Support Structure Mass (T)	7.9	7.9	14.2
Propellant Mass (T)	190.5	190.5	102.7
Total Mass (T)	200.0	200.0	139.0

Propellant depot preliminary sizing has been based on data available in the "Orbital Propellant Handling and Storage Systems for Large Space Programs" study report (Reference 39). This study was performed by Convair for NASA JSC under contract (NAS9-15305) to conceptually design and evaluate large hydrogen, oxygen, and argon storage depots in LEO. Based on the information generated by this study we have selected the LEO depot size closest to 2,268 T (5 M lb) propellant capacity with a 6:1 LO_2/LH_2 mixture ratio. This results in a depot with 10 oxygen modules, 3 hydrogen modules, and a total propellant capacity of 2,213 T. Reliquefaction equipment is included as part of the depot to eliminate propellant boil-off losses. Boiloff rates were based on Reference 39 data for 60 and 30 layers of superinsulation on the LH_2 and LO_2 storage modules respectively. Depot subsystem mass estimates (excluding propellant modules) are given in Table 4-27. The overall LEO propellant depot characteristics are shown in the LRU element data sheet of Figure 4-16.

Table 4-27. LEO Depot Mass Estimate.

		Mass (T)
Basic Platform Structure	=	13.6
Propellant Xfer Plumbing	=	1.8
ACS and Avionics	=	0.8
Reliquefaction Equipment	=	1.4
Solar Array Power Supply	=	0.7
Reliquefaction Radiators	=	1.4
10% Contingency	=	<u>2.0</u>
TOTAL MASS (T)	=	21.7

Other Orbital LH_2/LO_2 Depots

The configuration of LH_2/LO_2 propellant depots located in LLO and at the space construction base or SMF can be similar to the LEO depot of Figure 4-16. If there are any significant differences, they will probably involve the capacity and configuration of the propellant storage modules. The design of LEO depot propellant modules is constrained by the SDV payload capability and the high g forces needed to leave earth. In-space transport of propellant modules is not

Figure 4-16.

LRU ELEMENT DATA SHEET
GENERAL DESCRIPTION

<input type="checkbox"/>	Material Processing	Element Definition	<u>LH₂/LO₂ Propellant Depot in</u>
<input type="checkbox"/>	Transportation		<u>LEO Incl. Reliquefaction</u>
<input checked="" type="checkbox"/>	Infrastructure	Sizing Assumptions	<u>Propellant Modules Sized for SDV</u>
<u>Delivery (200 T Payload Capability)</u>			

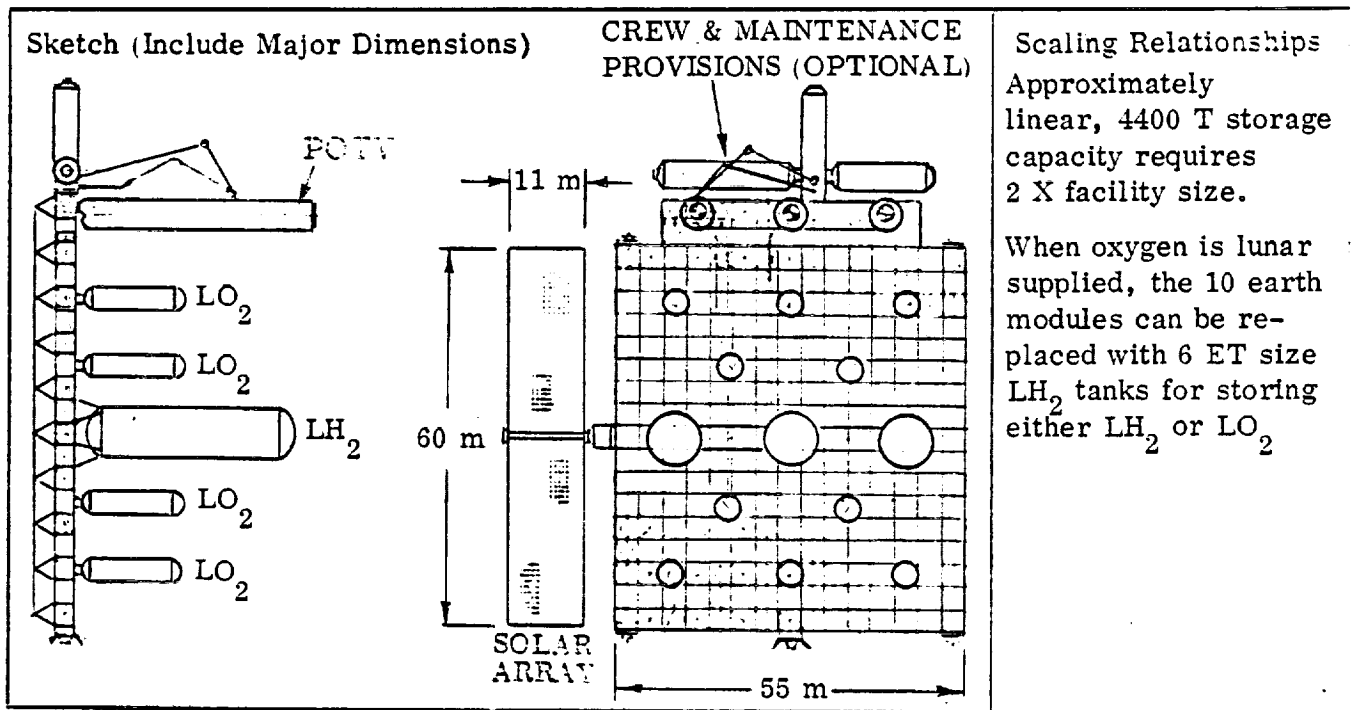

PHYSICAL CHARACTERISTICS:

Inert Weight	<u>114 T</u>
Consumable Wt.	<u>N/A</u>
Gross Weight	<u>2327 T</u>
Throughput	<u>17 T/hr/POTV</u>
Storage Cap.	<u>2213 T</u>

Total Volume	<u>6319 m³</u>
Array Area	<u>667 m²</u>
Radiator Area	<u>174 m²</u>
Assembly Location	
Initial	<u>LEO</u>
Final	<u>LEO</u>

Delivery Vehicle

<input type="checkbox"/>	Shuttle
<input checked="" type="checkbox"/>	SDV
<input type="checkbox"/>	HLLV
<input type="checkbox"/>	COTV
<input type="checkbox"/>	LTV

PERFORMANCE CHARACTER:

Thrust Level	<u>N/A</u>
Specific Impulse	<u>4.2 kN-s/kg (ACS)</u>
Acceleration	<u>N/A</u>
Payload Cap.	<u>N/A</u>
Transfer Time	<u>N/A</u>

Power Req'd	<u>100 KW</u>
Efficiency	<u>N/A</u>
Consumables	<u>1% Stored Prop.</u>
Waste Heat	<u>N/A</u>
Flow Rates	<u>19 kg/hr Venting</u>
Useful output	<u>N/A</u>

Personnel Req'ts.

<input type="checkbox"/>	Primary
<input type="checkbox"/>	Support
<input type="checkbox"/>	Supervisory
<input type="checkbox"/>	Ground
<input type="checkbox"/>	Total

Data Source(s) Orbital propellant handling & storage systems for large space

programs NAS9-15305 CASD-ASP-78-001 Updated per Bock's AIAA Tech Paper for Reliquefaction Sizing.

Prepared by E. H. Bock

Reviewed by _____

subject to either of these limitations. COTV's will operate at very low thrust to weight ratios with very large payloads. Therefore, the use of SDV propellant delivery modules for subsequent propellant delivery to LLO or SMF would be inefficient. Lightweight superinsulated rigid tanks would obviously be superior for in-space transport applications, except they must either be delivered from earth empty or constructed in space. A third possibility involves the use of lightweight superinsulated flexible propellant containers. These flexible containers could be delivered from earth in a high density collapsed configuration, and be filled (i. e., expanded) on orbit from the LEO depot. Further, these flexible propellant containers could be used both as propellant storage/transport modules and as COTV propellant tanks. Their flexible configuration would provide positive propellant control and orientation functions by being purposely contracted as propellant is withdrawn. Only two disadvantages to the flexible container approach are evident; 1) protection from meteoroid damage (excessive leakage) and 2) suitable material flexibility at cryogenic temperatures. If these two concerns are solvable, flexible containers probably constitute the best approach for propellant transport in space.

A sketch of one possible flexible container configuration is shown in Figure 4-17. The propellant containment membrane is constructed of a high strength fiber reinforced plastic, and is configured to readily fold into a more compact cylinder as propellant is removed. Container compaction and propellant removal is accomplished by a cylindrical net which mechanically squeezes the containment membrane. The propellant outlet and other disconnects for propellant boiloff venting, reliquefied propellant recharge, and power are housed in a panel/docking interface attached to the container services standpipe. The superinsulation system surrounds the bag and squeeze net, and after initial deployment, remains in its fully deployed position independent of the propellant quantity contained in the membrane. Preliminary calculations indicate that a propellant container of this type with a volume equal to the ET hydrogen tank, has approximately 1/3 the mass. Its initial dry delivery volume is less than 1/10 that of the rigid ET hydrogen tank.

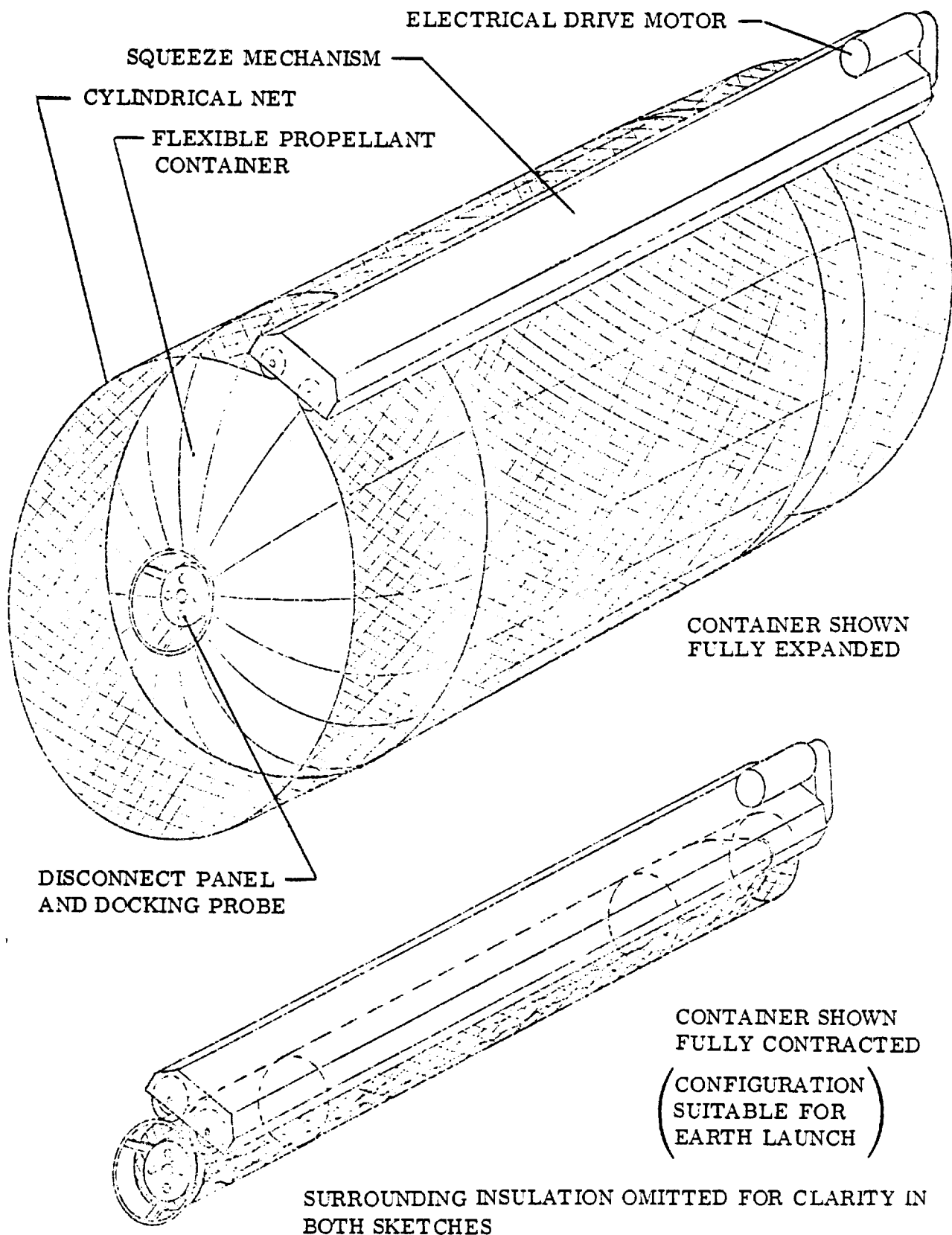

Figure 4-17. Flexible container configuration.

All reliquefaction equipment and container power (for low g thermodynamic vent and squeeze mechanism) is assumed to be supplied by the support facility, either the depot during storage or the COTV during transport.

The LLO propellant depot configuration will also be dependent on the payload capability of the lunar cargo transfer vehicle and the LO₂ transport module design. If oxygen produced on the lunar surface is to be used as POTV oxidizer and Ion electric COTV propellant, it must be lifted to the LLO propellant depot. Although lunar gravity is only 1/6 g, rigid containers will be required for this relatively high thrust transfer. These containers must either be brought from earth or manufactured in space. One interesting possibility is to use the SDV LO₂ propellant transport modules for the lunar application. These LO₂ modules will no longer be needed in LEO once lunar derived oxygen becomes available, since previously emptied LH₂ modules or flexible containers can then be used for LEO oxygen storage. If we ignore the logistics problems involved with getting these LO₂ modules to the moon, they appear to be an excellent choice. Preliminary CLTV sizing indicates that two of these 200 T modules could be conveniently lifted into LLO at one time. After their propellants are transferred via the depot to OTV's or flexible container delivery modules, the rigid LO₂ transport modules can be brought back to the lunar surface for reuse.

Mass estimating procedures for LH₂/LO₂ depots must be available which are independent of stored propellant mixture ratio. Based on the proposed LEO depot configuration and the use of rigid tanks or flexible propellant storage containers, the following equations may be used to obtain LH₂/LO₂ depot mass.

$$M_{\text{Depot}} = M_{\text{LH}_2 \text{ Storage Equip.}} + M_{\text{LO}_2 \text{ Storage Equip.}}$$

$$M_{\text{Depot}} = K_{\text{LH}_2 \text{ Depot}} \frac{W_{\text{LH}_2 \text{ Prop}}}{\text{Capacity}} + K_{\text{LO}_2 \text{ Depot}} \frac{W_{\text{LO}_2 \text{ Prop}}}{\text{Capacity}}$$

The constant values (K) are dependent on the type of storage container assumed. Table 4-28 lists constants for the earth launched oxygen and ET hydrogen tanks

described in Table 4-26 plus large flexible containers of common design used for in-space transfer and storage of either propellant.

Table 4-28. Depot Sizing Constants.

Storage Configuration	$K_{\text{LH}_2 \text{ Depot}}$ ($T_{\text{Depot}}/T_{\text{LH}_2}$)	$K_{\text{LO}_2 \text{ Depot}}$ ($T_{\text{Depot}}/T_{\text{LO}_2}$)
Rigid Storage Tanks Sized for SDV Delivery	0.264	0.0212
Flexible Containers for In-Space Use (Volume Equivalent to ET LH ₂ Tank)	0.126	0.0079

A slight improvement (approximately 10% lower) in Table 4-28 K values is obtained for remote depot locations such as GEO, due to the availability of almost continuous sunlight (photovoltaic power supply) for boiloff reliquefaction.

Lunar Surface Oxygen Liquefaction Facility

The lunar surface propellant facility for systems Concepts C and D must liquefy gaseous oxygen produced by anorthite processing so that it can be easily transported and stored in the various orbiting depots. Liquefaction equipment sizing has been based on preliminary material requirements analyses of Section 4.2, which indicates oxygen propellant requirements of ~2.5 times the total SPS mass. For a construction rate of one 10 GW SPS per year, approximately 250,000 T/yr of LO₂ is needed. Depending on the anorthite processing technique selected, liquefaction location, and the power supply source, this corresponds to liquefaction rates of 60 T/hr during the lunar day, or 28.6 T/hr continuously. Preliminary definition of this liquefaction equipment (not including the power supply) is contained in Table 4-29.

This equipment estimate was derived from data in the NAS9-19305 propellant handling study by employing the following assumptions.

Table 4-29. Lunar oxygen liquefaction equipment mass estimate.

	Continuous Operation	Sunlit Operation
Oxygen Liquefaction Rate (T/hr)	28.6	60
Power Required (MW)	24	50
Equipment Mass Estimate (T)	1,080	2,270
Liquefaction Equipment	(185.5)	(390.1)
Heat Exchangers & Pumps	(5.9)	(12.4)
Radiator and Transport Fluid	(815.3)	(1,714.2)
Avionics Controls Etc.	(6.7)	(13.3)
Structural Enclosure & EC/Access	(66.6)	(140.0)

- 1) Radiator equipment mass required for thermal energy dissipation on the lunar surface will be approximately twice that needed in low earth orbit. This mass increase is primarily due to the larger radiator area required to account for the higher effective sink temperature and lunar surface view factor.
- 2) The liquefaction equipment, heat exchangers, and pumps are enclosed by a pressure shell to protect the equipment and allow shirtsleeve maintenance. Pressurizable equipment tunnels have also been provided for maintenance access to the radiator manifolds and storage module propellant transfer lines.

A sketch of the lunar surface LO₂ depot is included in the LRU element data sheet of Figure 4-18. An ET hydrogen tank has been used as a convenient housing for the liquefaction equipment. An airlock and environmental control module are attached to it to provide personnel access and life support. The radiator assembly is oriented east/west and has a small sun shield to prevent direct illumination during lunar day operation. The equipment housing cylinder and access tunnels are all covered with 2 meters of lunar soil to provide thermal insulation and cosmic ray protection for maintenance personnel.

SMF Oxygen Liquefaction Facility

Systems Concept B employs a mass driver catapult on the lunar surface to supply an orbital processing and manufacturing facility with raw lunar material. Although the total oxygen propellant requirements are reduced for Concept B, a substantial amount is still required for POTV oxidizer and COTV propellants. The orbital liquefaction depot required to supply this oxygen differs from the comparable lunar surface facility in two respects; the radiator area and mass requirements are considerably reduced for in-space operation, and flexible propellant containers rather than rigid tanks can be used for L_2O_2 storage and transport. It has been conveniently assumed that the SMF is located in an orbit which is almost always illuminated by the sun. Since sun light is continuously available, a photovoltaic array is probably the most desirable source of electrical energy. Table 4-30 gives an estimate of the equipment mass for an orbital oxygen liquefaction plant and its photovoltaic power supply. Figure 4-19 depicts an orbital oxygen liquefaction plant with equivalent capability to the lunar surface depot of Figure 4-18.

Table 4-30. SMF Oxygen liquefaction equipment mass estimate.

Oxygen Liquefaction Rate (T/hr)	28.6
Power Required (MW)	23.2
Power Supply Mass Estimate (T)	125
Liquefaction Depot Mass Estimate (T)	633
<hr/>	
Liquefaction Equipment	(185.5)
Heat Exchangers & Pumps	(3.0)
Radiator and Transport Fluid	(407.7)
ACS and Avionics	(8.5)
Structural Enclosure, Etc.	(28.3)

The complete SMF propellant depot for systems Concept B will combine the oxygen liquefaction facility of Figure 4-19 with a hydrogen/oxygen storage depot similar to that shown in Figure 4-16. All propellant storage modules will probably be like the flexible container configuration shown in Figure 4-17.

Figure 4-19.
LRU ELEMENT DATA SHEET
GENERAL DESCRIPTION

<input type="checkbox"/>	Material Processing	Element Definition	<u>SMF Oxygen Liquefaction Facility</u>
<input type="checkbox"/>	Transportation		
<input checked="" type="checkbox"/>	Infrastructure	Sizing Assumptions	<u>Produce 28.6 T LO₂ Per Hour -</u>
	<u>Photovoltaic Power Supply Included</u>		

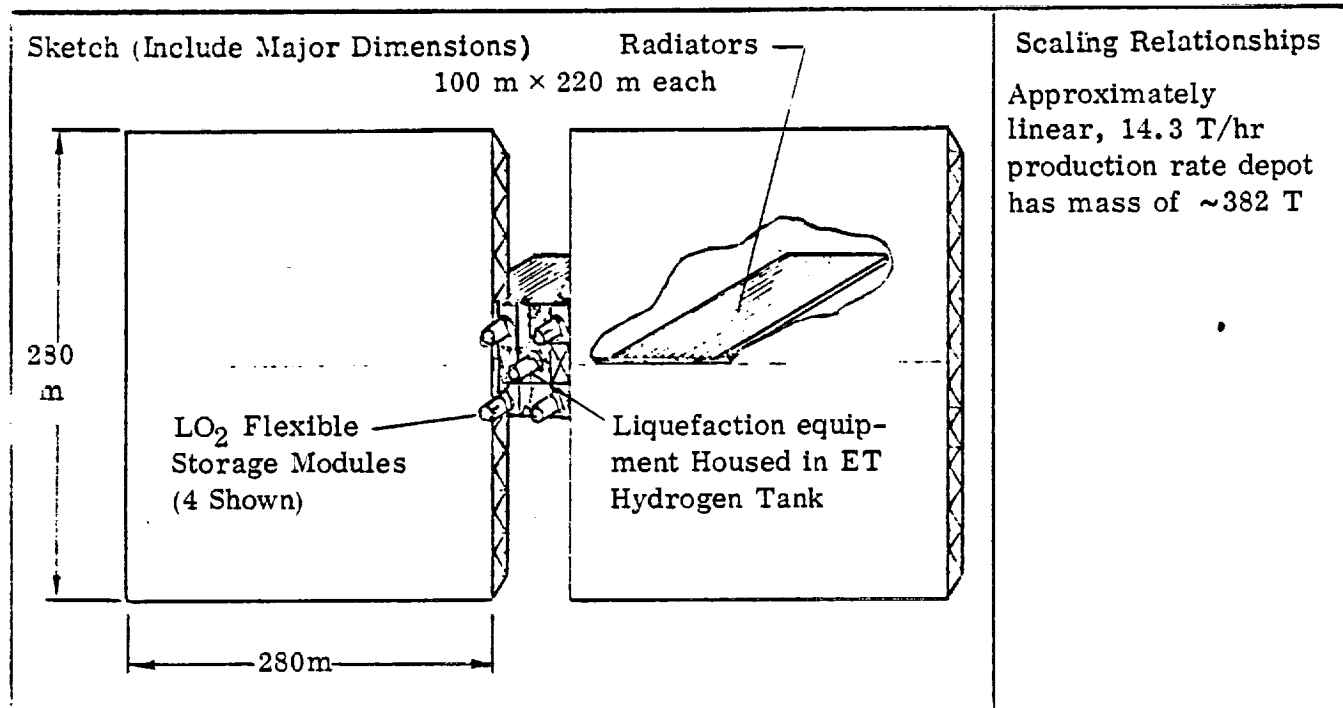

PHYSICAL CHARACTERISTICS:

Inert Weight	<u>758 T</u>
Consumable Wt.	<u>N/A</u>
Gross Weight	<u>758 T</u>
Throughput	<u>28.6 T/hr</u>
Storage Cap.	<u>1650 T/Module</u>

Total Volume	<u>1523 m³/Module</u>
Array Area	<u>155,200 m²</u>
Radiator Area	<u>44,000 m²</u>
Assembly Location	
Initial	<u>LEO</u>
Final	<u>SMF Orbit</u>

Delivery Vehicle

<input type="checkbox"/>	Shuttle
<input checked="" type="checkbox"/>	SDV
<input type="checkbox"/>	HLLV
<input checked="" type="checkbox"/>	COTV
<input type="checkbox"/>	LTV

PERFORMANCE CHARACTER:

Thrust Level	<u>N/A</u>
Specific Impulse	<u>4.2 kN-s/kg (ACS)</u>
Acceleration	<u>N/A</u>
Payload Cap.	<u>N/A</u>
Transfer Time	<u>N/A</u>

Power Req'd	<u>23.2 MW</u>
Efficiency	<u>0.3 kW-hr/lb LO₂</u>
Consumables	<u>≈1% Stored Prop</u>
Waste Heat	<u>N/A</u>
Flow Rates	<u>28.6 T/hr</u>
Useful output	<u>250,000 T/yr.</u>

Personnel Req'ts.

<input type="checkbox"/>	Primary
<input type="checkbox"/>	Support
<input type="checkbox"/>	Supervisory
<input type="checkbox"/>	Ground
<input type="checkbox"/>	Total

Data Source(s) Orbital Propellant Handling & Storage Systems for Large Space Programs

NAS 9-15305 CASD-ASP 78-001

Prepared by E. H. Bock

Reviewed by _____

Propellant Storage and Liquefaction Facility Sizing Summary

Propellant depot sizing is a function of the propellant requirements of user vehicles, propellants supplied to other depots, and the propellant delivery/consumption schedule. Table 4-31 identifies the propellant storage quantity requirements for depots in LRU systems Concepts B, C and D based on steady state logistics scenario analyses. Details for development of these storage quantities are contained in Tables G-44 through G-46 of Appendix G in Volume III. The six month storage time used for most depots reflects the twice per year delivery schedule of ion electric COTV's. Reduced storage periods can be used for some LLO depots and the lunar surface depots since the primary delivery vehicles (for oxygen) are scheduled daily. A minimum one month storage allowable is considered prudent to account for processing variations during the lunar day/night cycle.

Depot mass estimates were based on propellant storage in rigid modules suitable for delivery from earth with the Shuttle derived vehicle. The LO_2 module has a 190.5 T capacity and an inert mass of 2.6 T, while the LH_2 module has a 102.7 T capacity and an inert mass of 22.1 T. Depot mass was determined by the relationship:

$$M_{\text{Depot}} = 190.5 K_{\text{LO}_2}^{\text{Depot}} N_{\text{LO}_2}^{\text{Storage Modules}} + 102.7 K_{\text{LH}_2}^{\text{Depot}} N_{\text{LH}_2}^{\text{Storage Modules}}$$

where $K_{\text{LO}_2}^{\text{Depot}} = 0.0212$ and $K_{\text{LH}_2}^{\text{Depot}} = 0.264$ and N is the quantity of storage modules

Liquefaction facilities are required adjacent to each LRU option's lunar material processing facility to process gaseous oxygen obtained from lunar soil into liquid propellant. Equipment mass estimates were derived from data in the NAS9-19305 propellant handling study using the following assumption: For the SMF, a 5 percent downtime due to shadowing plus a 15 percent maintenance allowance was used to define the required processing rate. For the lunar surface facility a 25 percent maintenance allowance for continuous operation was used to define the required processing rate. A configuration summary is included in Figure 4-20 to depict the general arrangement of recommended depot and liquefaction facilities.

Table 4-31. Propellant Facility Sizing Summary.

		Concept B		Concept C		Concept D	
		LO ₂	LH ₂	LO ₂	LH ₂	LO ₂	LH ₂
Storage Facilities	LEO	6-month storage		6-month storage		6-month storage	
	Propellant (T)	3,158.3	687.9	4,588.2	5,100.5	3,254.0	485.8
	Storage modules	17	7	25	50	18	5
	Depot mass (T)	258.5		1456.6		208.3	
Storage Facilities	GEO	6-month storage		6-month storage		6-month storage	
	Propellant (T)	81.8	11.7	454.3	64.9	454.3	64.9
	Storage modules	1	1	3	1	3	1
	Depot mass (T)	31.2		39.2		39.2	
Storage Facilities	LLO	6-month storage		4-months-3		4-month storage	
	Propellant (T)	56.4	8.1	6,727.8	2,396.3	6,116.9	133.0
	Storage modules	1	1	36	24	33	2
	Depot mass (T)	31.2		796.1		187.5	
Storage Facilities	SMF or moon	6-month storage		1-month storage		1-month storage	
	Propellant (T)	9,938.5	480.1	7,178.2	—	12,927.3	5,135.3
	Storage modules	53	5	38	0	68	AI
	Depot mass (T)	349.6		153.5		274.6	
Liquefaction facility		SMF		Lunar Surface		Lunar Surface	
Annual LO ₂ reqt (T)		19,877.0		86,138.4		55,127.7	
Processing rate (T/hr)		2.72		12.29		22.14	
Facility mass (T)		75.8		486		836	

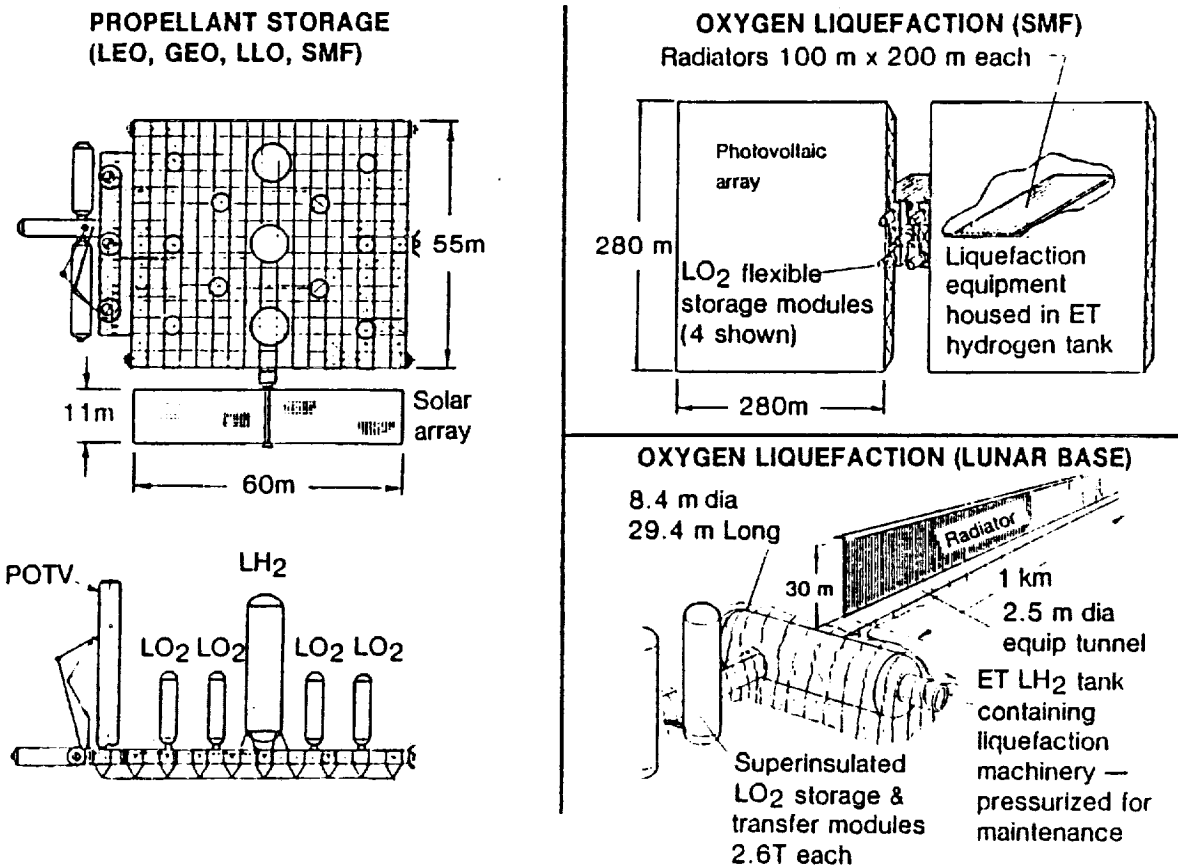

Figure 4-20. Configuration Summary.

4.5.2 Habitats - Living quarters are required at each major lunar resource utilization activity location, and temporary shelters may be needed at unmanned equipment installations to accommodate maintenance personnel. Requirements for manned space stations can best be characterized by the criteria shown in Table 4-32. Duty tour durations shown are conservatively low, and experience with lunar surface living or with larger habitats incorporating pseudogravity may allow significant stay time extensions.

Table 4-32. Habitats are grouped by three major parameters.

Habitat Description	Location	Population Size	Nominal Duty Tour	Group
LEO Logistics Station	Beneath Van-Allen Belts	10's (If Req'd)	2-3 Months	1
LLO Shelter	Deep-Space	10's	7 Days	2
Lunar Base	Lunar Surface	10's → 1,000's	6 Months	3
Lunar Outposts	Lunar Surface	~10	14 Days	2
L ₂ Shelter	Deep-Space	~10	7 Days	2
SMF Living Quarters	Deep-Space	100's → 1,000's	6 Months	4
GEO Main-tenance Facility	Deep-Space*	10's → 100's	2-3 Months	1

*In Upper Van-Allen Radiation Belt

Four natural groupings occur from these criteria, as shown in the table's right column. The most significant habitat design discriminators in addition to population and stay time are the requirements for pseudogravity and radiation protection. Pseudogravity

is implemented by spinning the habitat to provide centrifugal inertia force, and is a physiological requirement for duty tours exceeding 6 months, based on optimistic extrapolation of Skylab medical results. Protection from solar flare and/or galactic radiation is a requirement for all habitats unprotected by earth's Van Allen belts. This protection must be provided by shielding, which is easily supplied for lunar surface installations by covering habitats with several meters of lunar regolith. Similar shielding for deep space habitats must be transported to their location from the lunar surface or supplied from earth.

Group 1 habitats have been studied extensively by NASA and industry since the early 1960s, and a substantial data base is available (References 40 through 45).

Group 2 habitats are temporary shelters which provide environmental protection and cramped personnel comfort facilities (bed, board and bathroom). Their conceptual design and programmatic definition can be easily derived from Group 1 space station studies, except for a required solar flare storm shelter to protect personnel for up to several days.

The Group 3 habitat, or lunar base concept, was also studied by NASA (References 46 and 47) during 1971 and 1972. The bases in both these studies were configured primarily for scientific research with crew sizes from 12 to 180. Portions of these studies, if appropriately scaled, should be suitable for LRU lunar base definition. Larger lunar base habitats were proposed during the 1977 Ames summer study (References 48 and 49) which make use of Shuttle external tanks.

Group 4 habitat concepts have received considerable attention during all three Ames summer studies involving space industrialization (References 50, 51 and 52). The conceptual design philosophy used for these very large habitats is visionary but not directly applicable for early SMF personnel needs. Since the space station designs in Group 1 are zero-g facilities and much too small, and permanent space settlement

concepts are too large, a compromise approach is needed. Several papers have considered intermediate one-g habitats in the 100s to 1000s population size (References 48 and 51). The former concept uses clustered ET hydrogen tanks for pressure shells, with ECLSS, airlock/docking-adapater, power/thermal control system, communications modules, and internal furnishings brought up by Shuttle in kit form and installed on-orbit.

The sensitivity of the seven habitat types (Table 4-32) to LRU systems Concepts B, C and D is primarily associated with population size and shielding delivery method. Table 4-33 identifies these differences. The shielding mass

Table 4-33. Habitat design requirements are sensitive to LRU systems concepts.

Habitat	Lunar Resource Utilization Systems Concept		
	Concept B	Concept C	Concept D
LEO Logistics Station	—— Similar Population, Operations & Design —— (If Required)		
LLO Shelter	—— Similar Support Requirements & Design ——		
Lunar Base	— Small — (Lunar Mining & Matl Transport)	— Medium — (Mining, Processing, & Stock Mfg)	— Medium — (Mining, Processing & Stock Mfg)
Lunar Outposts	Required for Mass Driver Maintenance	——	Probably Not Required
L ₂ Shelter	Required for Mass Catcher Maintenance *	——	Not Required ——
SMF Living Quarters	— Large — (Industrial Slag Waste Shielding)	— Large — (Shielding Transported from Lunar Surface)	— Large —
GEO Maintenance Facility	Required	——	Included in SMF Functions ——

*If catcher is permanently stationed in vicinity of L₂

requirement for the SMF habitat may be a significant design constraint and cost item, since some studies have shown shielding mass for long duration inhabitants to exceed the remaining habitat mass by a factor of at least 10. If this shielding must be delivered from the moon as dedicated payload, its cost will be substantial. Obviously a trade exists between crew stay time and the amount of shielding required. The advantage of using fully trained and experienced personnel is countered by the transport cost of additional habitat shielding.

Group 1 Habitats — Requirements for these relatively small LEO and GEO habitats are very similar to space stations defined in the 70's for experimental applications. The earliest 70's work (References 40 and 41) involved a 10m diameter four deck core station delivered in one piece by a Saturn Launch Vehicle. This space station was capable of accommodating a crew of 12, and growth versions up to 50 personnel were proposed. The two study contracts were extended in mid-1970 to revise these space stations to allow delivery with the newly proposed Space Shuttle (References 42 and 43). A modular approach was employed so that each module would fit within the Shuttle Orbiter's 4.6m diameter by 18.3m long payload bay. The baseline modular space station consisted of six modules and was capable of supporting a crew of six. Expansion to accommodate 12 crew members was accomplished by adding 2 or 3 more modules and additional photovoltaic array. Most recently accomplished NASA space station activity (References 44 and 45) involved definition of early space construction facilities in LEO to demonstrate fabrication of space platforms.

Of these three configurations, the modular space station sized for Shuttle delivery appears to be closest to meeting lunar resource utilization program requirements. The 12 person growth station defined by Rockwell International (Reference 43) has been used as a basis for the LEO logistics station defined in Figure 4-21. This configuration consists of 9 modules including a power module, two core modules, and six crew accommodation modules. Cargo modules are employed to house supplies for the

Figure 4-21.
LRU ELEMENT DATA SHEET
GENERAL DESCRIPTION

<input type="checkbox"/>	Material Processing	Element Definition	<u>LEO modular space station</u>
<input type="checkbox"/>	Transportation		<u>Less than 60 person zero g facility</u>
<input checked="" type="checkbox"/>	Infrastructure	Sizing Assumptions	<u>Crew size of 12 persons</u>
			<u>Power supply included in habitat weight estimate</u>

<p>Sketch (Include Major Dimensions)</p>	<p>Scaling Relationships</p> <p>Approximately linear - 24 person crew requires 2 x facility size</p> <p>*Consumables for 3 months plus emergency oxygen & nitrogen for 96 hour rescue</p>
--	---

PHYSICAL CHARACTERISTICS:		Total Volume	<u>1048 m³</u>	Delivery Vehicle
Inert Weight	<u>72.0 T</u>	Array Area	<u>930 m²</u>	
Consumable Wt.*	<u>8.7 T</u>	Radiator Area	<u>680 m²</u>	<input checked="" type="checkbox"/> SDV
Gross Weight	<u>80.7 T</u>	Assembly Location		<input type="checkbox"/> HLLV
Throughput	<u>N/A</u>	Initial	<u>Earth</u>	<input type="checkbox"/> COTV
Storage Cap.	<u>N/A</u>	Final	<u>Service Location</u>	<input type="checkbox"/> LTV

PERFORMANCE CHARACTER:		Power Req'd	<u>26.7 kW</u>	Personnel Req'ts.
Thrust Level	<u>N/A</u>	Efficiency	<u>N/A</u>	
Specific Impulse	<u>N/A</u>	Consumables	<u>23 kg/day</u>	<input type="checkbox"/> 3 Support
Acceleration	<u>Zero g</u>	Waste Heat	<u>~24 kW</u>	<input type="checkbox"/> 1 Supervisory
Payload Cap.	<u>N/A</u>	Flow Rates	<u>N/A</u>	<input type="checkbox"/> Ground
Transfer Time	<u>N/A</u>	Useful output	<u>N/A</u>	<input type="checkbox"/> 12 Total

Data Source(s) "Modular Space Station," North American Rockwell Space Division,
Report No. SD71-217-1, January 1972

Prepared by E. H. Bock Reviewed by _____

space station.

In low Earth orbit, the Van Allen belts provide some protection from both galactic and solar flare radiation. For short crew stay times, the space station structure required to contain atmospheric pressure and provide thermal protection has been deemed acceptable for single mission radiation protection as shown in Table 4-34 (Reference 43). These single mission dosages are primarily due to an assumed solar flare event occurring once during the 90 day mission. If the flare does occur, crew members would be precluded from returning to space for subsequent long duration missions in similarly protected habitats. Thus new personnel, without previous in-space work experience would be needed for crew rotation.

Since repeated duty assignments in LEO are primarily dependent on the radiation dosage received from solar flares, a storm shelter could be used to extend mission duration and/or allow subsequent missions. Data in Reference 43 shows shielding requirements of 15.5 g/cm^2 aluminum to reduce radiation for average solar flare to 5 rem, which is the current annual U. S. standard whole body radiation level allowable for radiation workers. This corresponds to an additional 5 cm of aluminum shielding. If one of the crew accommodation modules is modified to provide storm shelter capability, 24.6T of aluminum shielding must be added, bringing the total 12 person LEO habitat inert mass to 96.6T.

Table 4-34. LEO modular space station radiation protection.
Data From Reference 43

Rem Dose Allowables (90-day exposure)	Dose Rate (270 n mi/55° orbit 0.175 aluminum equiv)
Skin 105 rem	75.2 rem
Eye 52 rem	98.6 rem -- goggles required during solar flare event
Marrow 35 rem	10.5 rem

A LEO station for support of SPS construction with lunar resources would be located in a 258 n. mi. orbit inclined 31 degrees, assuming use of KSC as the SDV launch facility. The radiation environment will be slightly different at this inclination due to the position of the Van Allen Belts, but shielding estimates based on previous 55 degree inclined space station studies should be adequate for preliminary sizing.

Deep space habitats, i. e., those located above earth's Van Allen Belts, require additional shielding to protect personnel from galactic and solar flare radiation (Ref 53 and 54). Figure 4-22 exhibits shielding requirements as a function of dose rate for galactic radiation.

Cosmic rays from the galaxy consist of a continuous source of isotropic and highly penetrating ionizing radiation. The radiation components which cause biological damage are the fully ionized heavy nuclei traveling at relatively low velocities. At this level of ionizing power the passage of a single iron nucleus through the human body destroys an entire column of cells along its trajectory. The total amount of energy dumped in the body is small, but it is concentrated intensively over localized regions. In the absence of any protective shielding the galactic cosmic radiation would deliver an annual dose of about 18 rem. The best protection against this radiation is passive shielding. However, shielding produces secondary product emissions due to nuclear interactions. The phenomenon of secondary particle production is important as noted in Reference 50. "When high-energy particles collide with shield material, they produce a great spray of particles, which in turn may produce even more particles. Consequently, the addition of a little shielding may, in the presence of highly energetic particles like those at the upper end of the cosmic ray spectrum, give rise to an even larger radiation dosage than if no shielding were used. There is also the possibility that a little shielding will slow down the rapidly moving heavy ions and make them more effective in the damage they do to tissue."

Figure 4-22. Galactic radiation protection for deep space habitats.

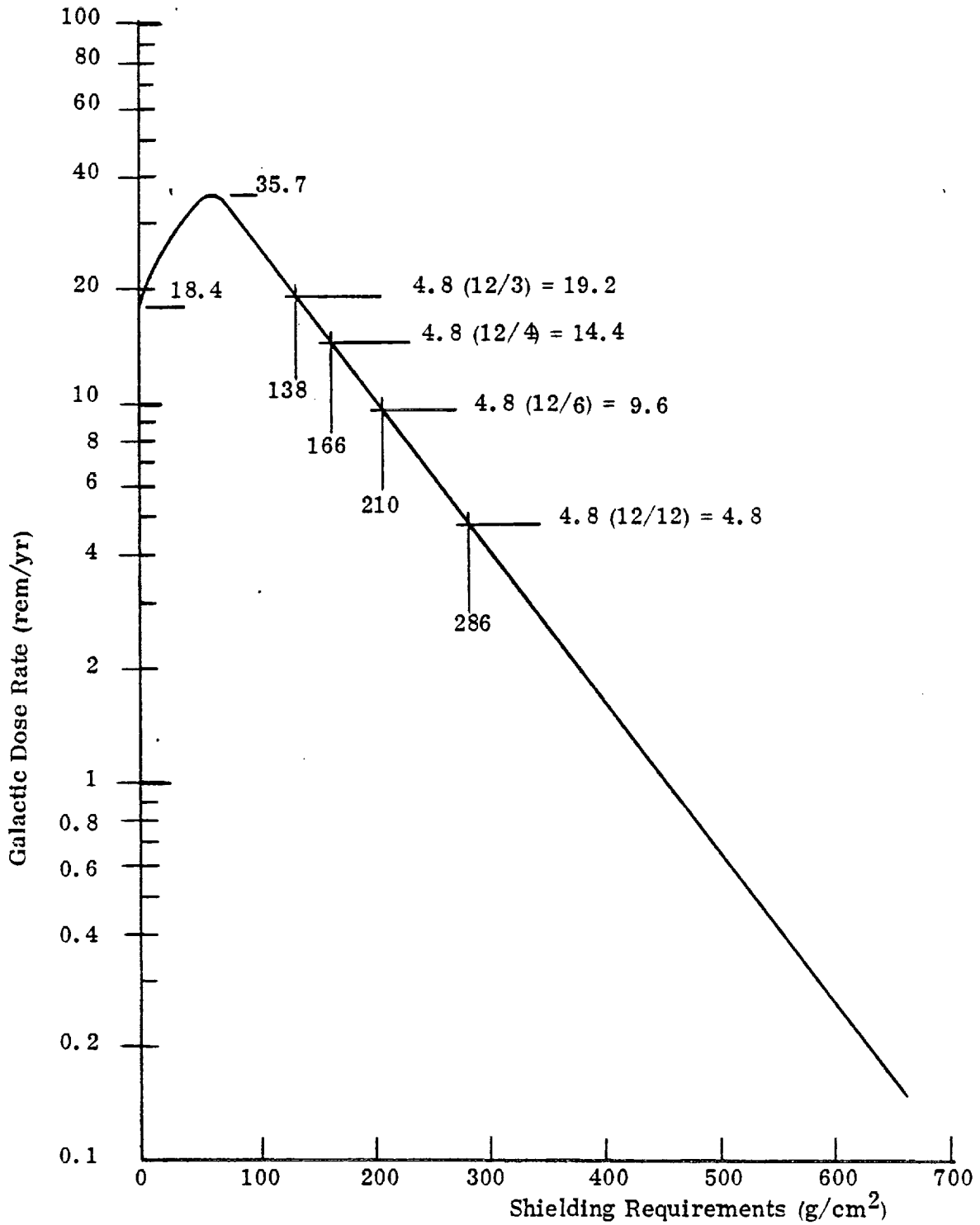

Data obtained from Reference 52.

Thus, for shielding that has a mass of a few tons per square meter of surface protected, the effect will be to increase the annual galactic radiation dosage from 18 rem to approximately 36 rem.

The other source of space radiation, caused by solar flares, is normally at an insignificantly low level, but can occasionally rise to extremely high levels.

Figure 4-23 shows the total radiation dose as a function of shield thickness for the proton component of an anomalously large flare approximating the intensity of the August 1972 flare. The secondary products are included in this calculation, but the dose from the alpha particles is ignored. The alpha flux, however, is less than 20% of the primary rem dose. The 1972 flare was considered very intense but on February 23, 1956, the largest flare on record took place. It has been estimated that during this flare people shielded by approximately 500 g/cm^2 would have received the allowable single emergency exposure of 25 rem (Reference 54). Fortunately, a flare of this magnitude occurs only once in 20 years.

If 5 rem per year is employed as the nominal dosage rate allowed due to galactic and solar flare radiation, shielding requirements can be determined as a function of personnel stay time by assuming that crew members will be limited to a maximum of one in-space duty assignment per year. If a storm shelter is supplied to protect crew members against very large solar flares (500 g/cm^2), nominally large flares such as the August 1972 occurrence will provide a dosage of approximately 0.2 rem. The remaining 4.8 rem is therefore contributed by galactic radiation. Table 4-35 indicates shielding requirements to provide this protection. An interesting phenomenon occurs for the 3 month stay time in a deep space habitat; the 138 g/cm^2 shielding gives protection equivalent to no shielding at all, due to the effect of nuclear interactions within the shielding. Thus limiting crews to less than 3 months per year in deep space, would only require a shielded solar flare shelter and no additional shielding on habitation modules.

Figure 4-23. Solar flare radiation protection for deep space habitats.

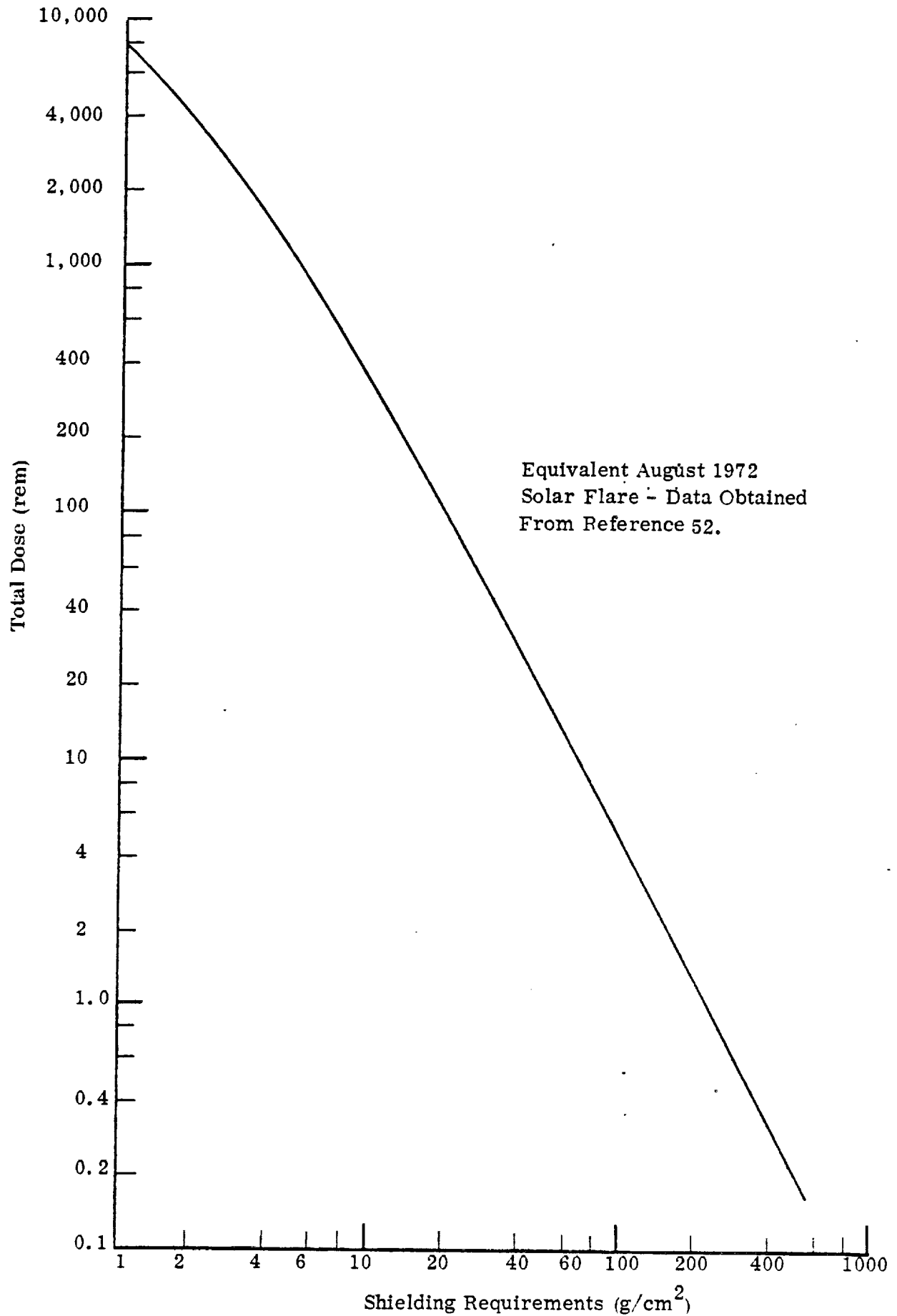

Table 4-35. Shielding requirements for deep space habitats.

Personnel Stay Time Per Year (Months)	Total Low Z Shielding Requirements (g/cm ²)	Equivalent Aluminum Thickness (m)	Galactic Shielding Mass For 12 Person Modular Station (T)
12	286	1.01	2,945
6	210	0.74	2,157
4	166	0.59	1,720
3	138	0.49	1,429
3	0	0	0

The solar flare shelter, with 500 g/cm² of shielding, must be capable of accommodating the entire habitat crew for up to several days. Conceptually this shelter should provide a comfortable but confined rest area with an assortment of entertainment media (books, movies, music, etc.) and simple food service facilities. Environmental control, life support, and utility services will be provided by the regular habitat module support systems. Using current commercial jet airliners as an analogy, approximately 1.5 m³/person will be required to meet these requirements. To minimize shielding mass, the most efficient shelter geometry (minimum surface area for a given volume) is spherical. The pressure shell plus all interior furnishings would be obtained from earth and the shielding mass would be provided by lunar materials, either as fused blocks or as sandbags. Table 4-36 gives estimates of shelter mass as a function of habitat crew size. Both earth and lunar delivered material requirements are identified. The total mass for a deep space < 3 month habitat can be obtained by summing the weights obtained from Figure 4-21 (properly scaled for crew size) and solar flare shelter weights from Table 4-36.

This approach of providing a solar flare shelter but no galactic radiation protection for smaller crew size short stay time habitats is very attractive from a total mass

Table 4-36. Solar flare shelter size and mass estimates.

Crew Size	Shelter Radius ⁽¹⁾ (m)	Mass From Earth ⁽²⁾ (T)	Shielding Mass ⁽³⁾ (T)	Total Mass (T)
12	1.63	1.70	396.47	398.2
24	2.05	3.03	541.03	544.1
50	2.62	5.22	770.50	775.7
100	3.30	7.63	1098.53	1106.2
200	4.15	11.27	1594.29	1605.6
400	5.23	22.54	2349.75	2372.3
800	6.59	45.08	3509.07	3554.2
1600	8.31	90.15	5298.73	5388.9
3200	10.46	180.30	8096.02	8276.3

(1) $r = \left[\frac{3}{4\pi} (\text{Crew Size}) 1.5 \frac{\text{m}^3}{\text{Person}} \right]^{1/3}$ r = Inside radius of shelter

(2) $m_{\text{Earth}} = m_{\text{pressure shell}} + m_{\text{furnishings \& supplies}}$ 206 MPa yield strength Aluminum pressure shell designed to contain a pressure of 2 Earth atmospheres

(3) $m_{\text{Shielding}} = \left[500 \text{ g/cm}^2 \text{ enclosing shelter sphere} \right] - m_{\text{pressure shell}}$

standpoint. By combining data in Figure 4-21, and Tables 4-35 and 4-36, the habitat mass requirements for longer stay times can be determined. These longer duration habitats require galactic radiation protection in addition to the solar flare shelter. Total habitat plus shielding mass for 3, 6 and 12 month habitats is shown in Table 4-37. As indicated, total mass requirements for longer than 3 month stay times increase by factors of 5.5 to 17.6 as crew size and duty tour increase. The disadvantage of 3 month crew rotations is the increased transportation cost. Figure

Table 4-37. Total habitat mass as a function of crew stay time.

Crew Size	Total Mass (T)				
	Crew Habitat Modules	Solar Flare Shelter	3 Month Stay Time	6 Month Stay Time	12 Month Stay Time
12	80.7	398.2	479	2,636	3,424
24	161.4	544.1	706	5,020	6,596
50	336.3	775.7	1,112	10,100	13,383
100	672.5	1,106.2	1,779	19,754	26,321
200	1345.0	1,605.6	2,951	38,901	52,034

B-26 (Appendix B, Volume III) shows material requirements sensitivity to personnel stay time for LRU System Concept C. At the 89.6 percent LRU level, doubling crew stay time for all 1,565 personnel decreases total Earth material requirements by approximately 13 percent. This corresponds to a reduction in SDV cargo of ~1180 T/year (for production of 1 SPS per year) and cuts Space Shuttle launches and therefore propellant requirements in half. Galactic shielding requirements shown are relatively inefficient due to the modular habitat configuration. For larger crew sizes (>50), more efficient habitat shapes having less surface area per unit of volume enclosed may considerably reduce the mass impact of galactic shielding and provide a favorable tradeoff with decreased personnel transportation requirements.

Group 2 Habitats — These temporary shelters are required to support maintenance personnel at remote locations. Generally, the equipment requiring service at these locations will be capable of supplying power for these temporary shelters when inhabited, so separate habitat dedicated power is not needed. The shelters must consist of at least two independent modules capable of providing essential services plus a common docking facility and an airlock for exterior access. This can be accomplished by two crew accommodation modules and a short core module from the modular space station

described in Figure 4-21. Galactic radiation protection will not be required since residence times for maintenance personnel will be brief. A shelter for solar flare protection would be desirable but perhaps not mandatory, since regular maintenance could be scheduled for quiescent solar activity periods. The minimum temporary shelter for six personnel is shown in Figure 4-24. For in-space shelter applications, the habitat will probably be attached to the operating equipment at that location. Lunar shelters will be adjacent to, but probably not connected with operating equipment located on the moon's surface.

Group 3 Habitats — Lunar base habitat crew size requirements range from relatively modest support for LRU Systems Concept B (48 people) to many 100's of people for Concepts C and D which include lunar surface manufacturing. This range of habitat populations can conceivably be satisfied by a variety of configurations and design concepts. These include earth fabricated modules similar to the LEO Space Station of Figure 4-21 for smaller populations, to the very large lunar base constructed in-place using lunar materials with only life support equipment and utility service kits brought from earth. Between these extremes lie larger pressure shell modules which consist of salvaged expendable propellant tanks and deployable/inflatable or prefabricated structures, all of which incorporate life support and utility service kits brought from earth. A relatively large lunar base is likely to consist of a mixture of these habitat types. Early exploration and base construction teams will require immediate lunar surface protection best provided by complete earth supplied modules. These can be used as construction shacks from which the base is expanded, initially using components obtained primarily from earth. The latter stages of expansion will permit larger module construction using lunar derived materials.

For the purposes of this study, fully equipped modular habitats will be assumed for small populations, and larger modules derived from Shuttle and Shuttle derived cargo vehicle expended external hydrogen tanks will be assumed for larger populations. The selection

Figure 4-24.
LRU ELEMENT DATA SHEET
GENERAL DESCRIPTION

<input type="checkbox"/>	Material Processing	Element Definition	<u>Temporary Shelter</u>
<input type="checkbox"/>	Transportation		<u>Less than 12 Persons Zero g Facility</u>
<input checked="" type="checkbox"/>	Infrastructure	Sizing Assumptions	<u>Temporary accommodations for 6 persons, power supply not included (power obtained from serviced facility)</u>

<p>Sketch (Include Major Dimensions)</p>	<p>Scaling Relationships</p> <p>Approximately Linear - Shelter designed for 12 person crew requires 2 x facility size & mass. Shelter can, however, temporarily accommodate at least 2 x nominal crew size for short periods.</p>
--	---

PHYSICAL CHARACTERISTICS:		Total Volume	<u>340 m³</u>	Delivery Vehicle	<input type="checkbox"/>	Shuttle
Inert Weight	<u>23.2 T</u>	Array Area	<u>N/A</u>		<input checked="" type="checkbox"/>	SDV
Consumable Wt.	<u>2.9 T</u>	Radiator Area	<u>225 m²</u>	<input type="checkbox"/>	HLLV	
Gross Weight	<u>26.1 T</u>	Assembly Location		<input checked="" type="checkbox"/>	COTV	
Throughput	<u>N/A</u>	Initial	<u>Earth</u>	<input type="checkbox"/>	LTV	
Storage Cap.	<u>N/A</u>	Final	<u>Service Location</u>			
PERFORMANCE CHARACTER:		Power Req'd	<u>~ 13 kW</u>	Personnel Req'ts.		
Thrust Level	<u>N/A</u>	Efficiency	<u>N/A</u>	<input type="checkbox"/>	6 Primary	
Specific Impulse	<u>N/A</u>	Consumables	<u>11 kg/Day</u>	<input type="checkbox"/>	Support	
Acceleration	<u>Zero g</u>	Waste Heat	<u>~ 8 kW</u>	<input type="checkbox"/>	Supervisory	
Payload Cap.	<u>N/A</u>	Flow Rates	<u>N/A</u>	<input type="checkbox"/>	Ground	
Transfer Time	<u>N/A</u>	Useful output	<u>N/A</u>	<input type="checkbox"/>	6 Total	

Data Source(s) "Modular Space Station" North American Rockwell Space Division,
Report No. SD71-217-1, January 1972

Prepared by E. H. Bock Reviewed by _____

of these two particular options has been accomplished without benefit of a trade study, and their employment should be viewed as representative.

Earth supplied lunar base habitat elements, including pressure shells, functional modules, and furnishing kits, are all subjected to a unique but obvious logistics consideration; they must be landed on the moon. Previous studies have concluded that the preferable handling technique for lunar delivered payload is via balanced mounting on either side of the lunar lander. This permits easy unloading by simultaneous lowering onto the lunar surface, and eliminates the need for a crane to remove a single axially mounted payload. Individual habitat element weights are therefore constrained to half the payload landing capability of the lunar transfer vehicle. This should present no difficulty for Concepts C and D since the LTV is sized for cargo transfer from lunar surface to LLO, but may affect Concept B since during steady state operations the only LTV requirement is for crew transfer and delivery of life support supplies.

Radiation and thermal protection for lunar base habitats is easily accomplished by covering the crew living and activity modules with several meters of lunar soil. The most efficient method of doing this involves placement of modules into ditches of approximately one-half module depth to reduce the quantity of coverage soil required. Due to this need for lunar base coverage, it also follows that the best module position is horizontal rather than vertical, which dictates internal design features for the habitat.

The lunar base for small crews has been derived from data contained in Reference 46. The configuration for a 12 person habitat is defined in Figure 4-25. Habitat consumables were estimated based on the following guidelines:

- (1) A fully closed water loop was assumed. Losses are made up by excess water accumulated from the non-dehydrated food supply.

Figure 4-25.
LRU ELEMENT DATA SHEET
GENERAL DESCRIPTION

<input type="checkbox"/>	Material Processing	Element Definition	Lunar Base Habitat, Incl
<input type="checkbox"/>	Transportation		Maintenance & Recreation Facilities
<input checked="" type="checkbox"/>	Infrastructure	Sizing Assumptions	Crew Size of 12 persons.

Power requirements defined (and implemented) independently of Habitat.

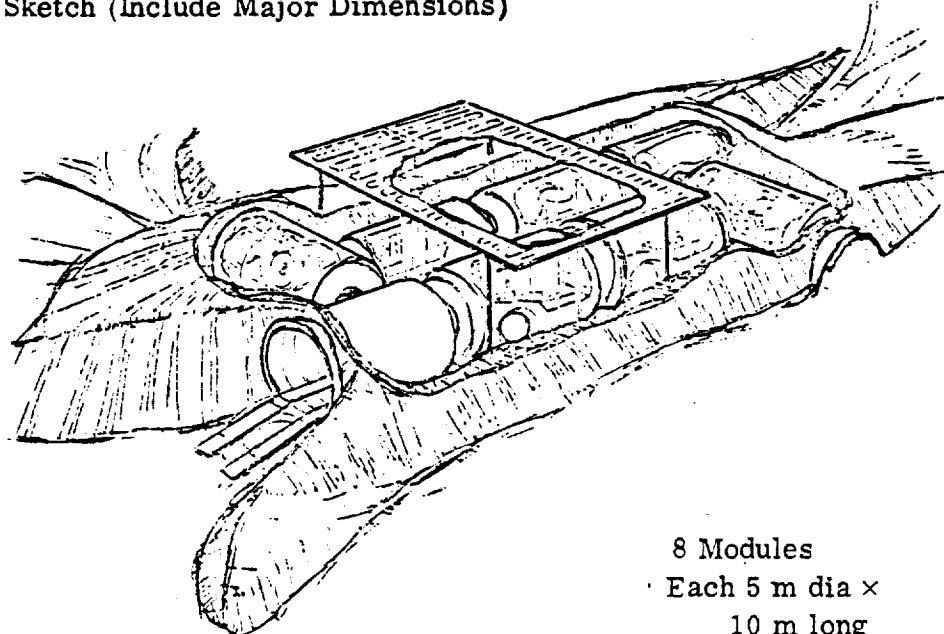
<p>Sketch (Include Major Dimensions)</p>  <p style="text-align: center; margin-top: 20px;">8 Modules Each 5 m dia × 10 m long</p>	<p>Scaling Relationships</p> <p>Approximately linear - 24 person crew requires 2 × facility size</p> <p>*Consumables for 6 months plus food and nitrogen for an additional 3 months</p>
--	---

PHYSICAL CHARACTERISTICS:

Inert Weight	28.6 T	Total Volume	1024 m ³		Delivery Vehicle
Consumable Wt.	17.6 T *	Array Area	N/A		<input type="checkbox"/> Shuttle
Gross Weight	46.2 T	Radiator Area	375 m ²		<input checked="" type="checkbox"/> SDV
Throughput	N/A	Assembly Location			<input type="checkbox"/> HLLV
Storage Cap.	N/A	Initial	Earth		<input checked="" type="checkbox"/> COTV
		Final	Lunar Surface		<input checked="" type="checkbox"/> LTV

PERFORMANCE CHARACTER:

Thrust Level	N/A	Power Req'd	20 kW		Personnel Req'ts.
Specific Impulse	N/A	Efficiency	N/A		<input type="checkbox"/> 8 Primary
Acceleration	1/6 g	Consumables	23 kg/Day		<input type="checkbox"/> 3 Support
Payload Cap.	N/A	Waste Heat	16 kW		<input type="checkbox"/> 1 Supervisory
Transfer Time	N/A	Flow Rates	N/A		<input type="checkbox"/> Ground
		Useful output	N/A		<input type="checkbox"/> 12 Total

Data Source(s) Lunar Base Synthesis Study NAS 8-26145

NAR SD 71-477 15 May 1971

Prepared by E. H. Bock Reviewed by _____

- (2) A fully closed oxygen loop was assumed. Losses due to leakage and airlock operation can be easily made up from lunar derived oxygen. Except for initial supply, no earth oxygen is required.
- (3) Assume nitrogen leakage and airlock losses of 0.1 kg/person/earth-day. This makeup is supplied from earth.
- (4) The food loop was assumed to remain open, with 1.8 kg/person/earth-day of frozen or packaged foods required.
- (5) A habitat atmosphere of oxygen and nitrogen with a nominal total pressure of 69 kPa(10 psi) was used (conforms to design requirements in Reference 46.
- (6) Assume an initial supply of consumables capable of sustaining the crew for 180 earth-days without any recycling, plus additional food and potable water for another 90 earth-days.

Table 4-38. itemizes the 12 person habitat consumable supplies obtained by employing these guidelines. Nominal crewperson requirements were based on data in Reference 46.

Table 4-38. Initial consumables for 12 person lunar base.

Consumables	Mass/Person/ Earth Day (kg)	Crew Size	Earth Days	Total Mass (T)
Potable H ₂ O	2.3	12	270	7.5
Wash H ₂ O	22.5	12	5*	1.4
Food	1.8	12	270	5.8
Oxygen	0.85	12	180	1.8
Nitrogen	0.1	12	180	0.2
Initial Atmos	—	12	—	0.9
*Recycled			Total	17.6

The 8 module 12 person lunar habitat shown in Figure 4-25 consists of a crew and medical module, crew and operations module, sortie and transient crew module, lab and backup command module, assembly and recreation module, base maintenance module, drive-in garage module, and drive-in warehouse module. As the base is expanded to accommodate additional personnel, and surface operations become more production/maintenance rather than scientifically oriented, the module functions needed will vary somewhat, although an equivalent of 8 more modules are probably required for each increment of 12 crew members.

The larger ~1,000 person size lunar base habitat is constructed of modules derived from external tanks brought to LEO by Shuttle and Shuttle derived launch vehicles. The Space Shuttle ET is normally jettisoned suborbitally when it has approximately 98 percent of its required orbital velocity, so it is relatively inexpensive to delay its separation until orbit is achieved. The ET consists of three major structural assemblies; the oxygen tank, intertank adapter, and hydrogen tank. The hydrogen tank is the largest of these and is best suited for use as a habitat pressure shell. It is 8.4 m in diameter by 29.4 m long with a volume of $1,520 \text{ m}^3$. Its welded aluminum structure is designed to contain 100 T of liquid hydrogen at 230 kPa through the relatively high loading conditions imposed during Shuttle ascent. This tank is capable of withstanding habitat loading conditions with a substantial margin of safety.

The utilization of these expended tanks is desirable since their delivery cost to LEO is negligible. For dedicated payloads, delivery to LEO is the most significant increment of earth to lunar surface transportation expense, so finding a useful application for normally discarded equipment already placed in LEO should be cost effective. The size of the ET hydrogen tank also permits interior design freedoms to enhance livability not possible with Shuttle or SDV constrained payloads. Each hydrogen tank is converted into one of several habitat types by the installation of functional modules such as Environmental Control and Life Support Systems (ECLSS) and connector segments,

and kits for interior structure, furnishings, and utilities. The installation of these modules and kits can be accomplished either in LEO or on the lunar surface. The LEO conversion is desirable for the earliest habitats if LTV performance capability is suitable for landing these heavier payloads.

A conceptual large lunar base consists of several residential modules clustered around a communal core module. A sketch of these two modules is contained in Figure 4-26. Both the residential and core modules have two floors with ceiling heights of 2.5 m. The residential module consists of ten 3.7×4.0 m studio apartments suitable for one or two people and two restrooms on each level. The core tank would provide dining and recreational facilities on the upper level, while the lower level contains the major access corridor to other lunar base clusters, and smaller meeting, gymnasium, laundry and special purpose rooms. Spiral stairways connect upper and lower levels.

An entire 1200 person base might be geometrically arranged as shown in Figure 4-27. Each of five clusters consists of three core modules and 12 residential modules capable of housing 240 people. The in line core modules are arranged so that three clusters meet at a hub. This forms a hexagonal pattern which can be expanded to accommodate lunar base growth. The hub could consist of a vertical ET hydrogen tank with an observation deck (or lounge) protruding above the lunar soil used to cover the other modules.

Each residential module has two 12 man ECLSS pods connected to it. One pod serves as the connecting passageway into the core module access corridor, and the other as emergency access to the utility services tunnel. Internal access is provided to all ECLSS equipment for maintenance, and each pod would have airtight doors to permit isolation of any residential module. Core modules are linked to each other and hub modules with interconnects, which are also equipped with pressure tight doors.

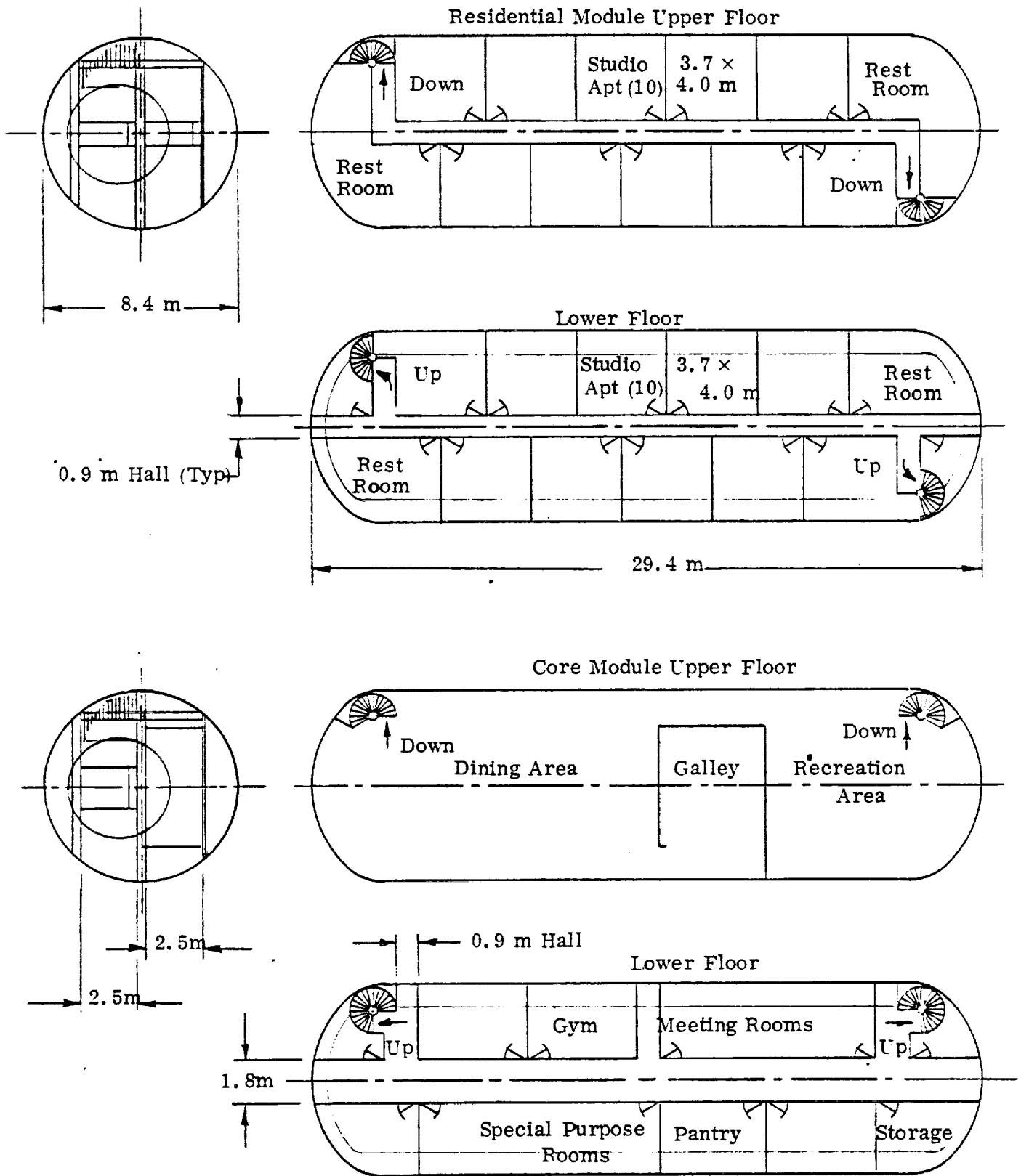

Figure 4-26. Configuration of lunar base habitat modules constructed from ET hydrogen tanks.

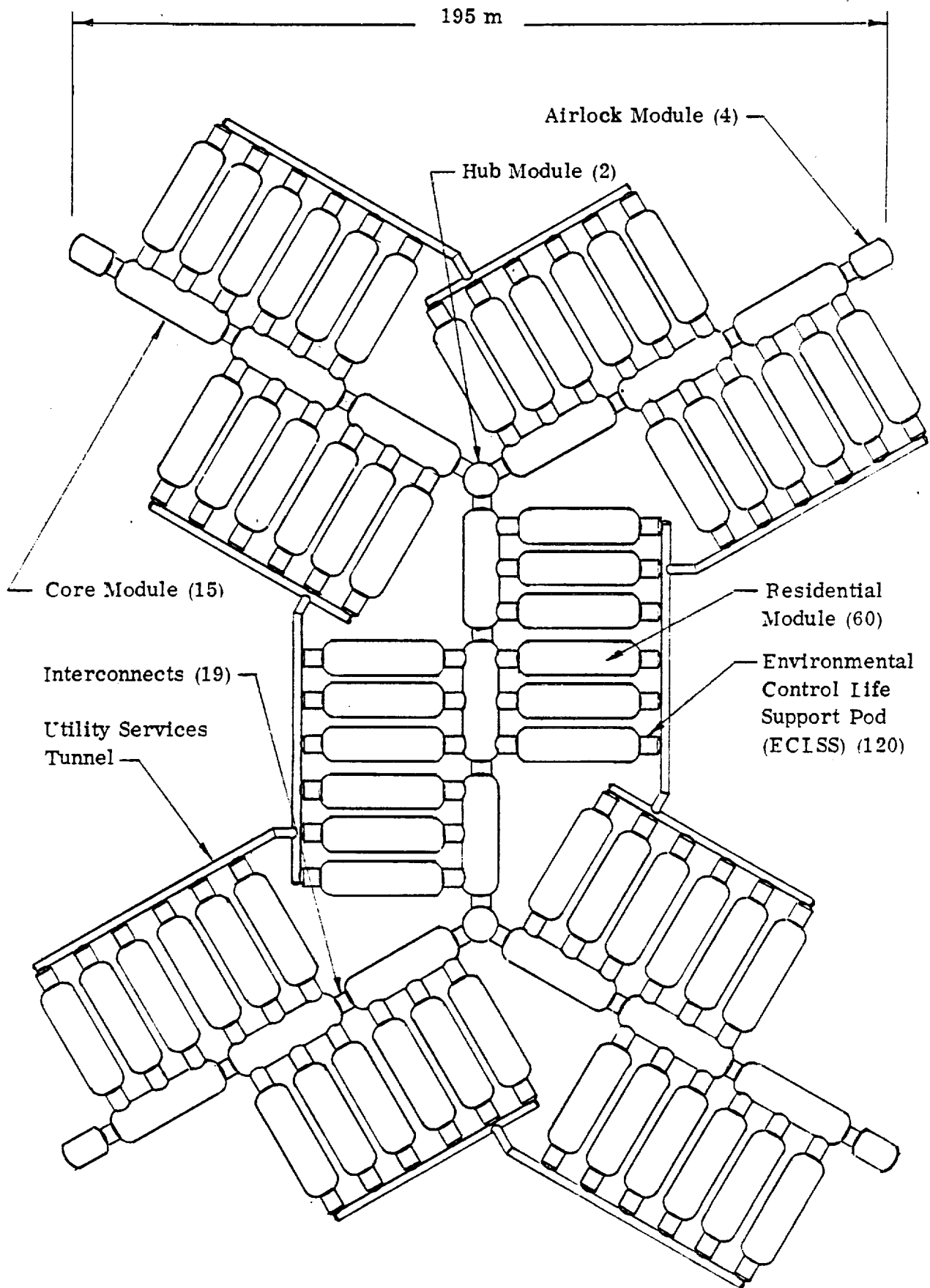

Figure 4-27. Conceptual geometric arrangement for 1200 person lunar base using ET LH₂ tanks.

The four core tanks at the habitat extremities are attached to airlocks rather than hub modules. These airlock modules include suit storage, donning and lunar dust removal facilities, plus an efficient airlock permitting convenient access to the lunar surface. High capacity pumps and high pressure air storage bottles are employed to limit oxygen/nitrogen loss during each airlock cycle. During lunar base expansion these airlock modules would be replaced by hubs, and relocated as required to service the expanded habitat configuration.

Utility service tunnels interconnect the "back" of residential modules via their ECLSS pods to provide an emergency access route. This 2 m diameter tunnel includes power and communication lines plus atmosphere makeup lines. The tunnel may operate unpressurized during normal circumstances, and only provide an atmosphere during maintenance or emergencies.

Overall lunar base characteristics are described in the LRU Element Data Sheet included as Figure 4-28. Mass estimates for the major habitat components are itemized in Table 4-39. Total living volume and area for the 1200 person lunar base is 117,300 m³ and 33,000 m² respectively. Power required has been estimated at 9 kW per person. This is relatively lavish compared to the 2.87 kW per person average power available in Skylab, but is considered reasonable for extended duration comfortable living. Initial consumable requirements were estimated using the same rationale as for the 12 person habitat, i. e., oxygen for 6 months and food and water for 9 months.

Class 4 Habitats — The Space Manufacturing Facility (SMF) habitat is located in deep space, and must support relatively large populations for extended duty tours. These requirements lead to two unique design features for Class 4 habitats; pseudogravity obtained by habitat rotation, and total residential volume envelopment by radiation shielding. The best description of an early habitat with these characteristics is contained in Reference 48. This habitat configuration, shown in Figure 4-29, is also based on the

Figure 4-28.
 LRU ELEMENT DATA SHEET
 GENERAL DESCRIPTION

<input type="checkbox"/>	Material Processing	Element Definition	Large Modular Lunar Base
<input type="checkbox"/>	Transportation		Constructed with ET LH ₂ Tanks
<input checked="" type="checkbox"/>	Infrastructure	Sizing Assumptions	1200 person habitat - power supplied by independent lunar surface facilities

<p>Sketch (Include Major Dimensions)</p> <p>60 Residential Modules 15 Core Modules 2 Hub Modules 4 Airlock Modules</p>	<p>Scaling Relationships</p> <p>Approximately liner - crew size of 600 personnel would have mass of ~2,000 T</p>
---	--

PHYSICAL CHARACTERISTICS:		Total Volume	117,300 m ³	Delivery Vehicle	
Inert Weight	4,163 T	Array Area	N/A	<input type="checkbox"/>	Shuttle
Consumable Wt.	1,773 T	Radiator Area	37,500m ²	<input checked="" type="checkbox"/>	SDV
Gross Weight	5,936 T	Assembly Location		<input type="checkbox"/>	HLLV
Throughput	N/A	Initial	LEO	<input checked="" type="checkbox"/>	COTV
Storage Cap.	N/A	Final	Lunar Surface	<input checked="" type="checkbox"/>	LTV
PERFORMANCE CHARACTER:		Power Req'd	10.8 MW	Personnel Req'ts.	
Thrust Level	N/A	Efficiency	N/A	<input type="checkbox"/>	Primary
Specific Impulse	N/A	Consumables	2.3T/Day	<input type="checkbox"/>	Support
Acceleration	1/6 g	Waste Heat	8.6 MW	<input type="checkbox"/>	Supervisory
Payload Cap.	N/A	Flow Rates	N/A	<input type="checkbox"/>	Ground
Transfer Time	N/A	Useful output	N/A	<input checked="" type="checkbox"/>	1200 Total

Data Source(s) "Habitat and Logistic Support Requirements for Initiation of a Space Mfg Enterprise," J. P. Vajk, 1977 Ames-OAST Summer Study

Prepared by E. H. Bock Reviewed by _____

Table 4-39 1200 person lunar base habitat mass estimate.

	Element Mass (T)	Qty Req'd for 1,200 Persons	Total Mass (T)
Residential Module - 20 Persons	<u>35.1</u>	60	2,106
ET LH ₂ Tank - Stripped of Bolt-ons	14.4		
Interior Structure	9.1		
Flooring 440 m ² @ 10 kg/m ²	4.4		
Ceiling 440 m ² @ 2.5 kg/m ²	1.1		
Partitions 560 m ² @ 5.0 kg/m ²	2.8		
ET Wall 320 m ² @ 2.5 kg/m ²	0.8		
Furnishings 450 kg/Person	9.0		
Other Miscellaneous Equipment (8%)	2.6		
Core Module - 80 Persons	<u>42.3</u>	15	635
ET LH ₂ Tank - Stripped of Bolt-ons	14.4		
Interior Structure	10.4		
Flooring 440 m ² @ 15 kg/m ²	6.6		
Ceiling 440 m ² @ 2.5 kg/m ²	1.1		
Partitions 370 m ² @ 5.0 kg/m ²	1.9		
ET Wall 320 m ² @ 2.5 kg/m ²	0.8		
Furnishings ~180 kg/Person	14.4		
Other Miscellaneous Equipment (8%)	3.1		
Hub Module	<u>48.7</u>	2	97
ET LH ₂ Tank - Stripped of Bolt-ons	14.4		
Interior Structure	16.5		
Furnishings	14.2		
Other Miscellaneous Equipment (8%)	3.6		
ECLSS Pods - 12 Person	<u>10.4</u>	120	1,248
Structure and Pressure Door	1.0		
Atmos Supply, Control & Re- conditioning	5.9		
Water and Waste Management	1.5		
Thermal Control Incl Radiator	4.0		
Airlock Module	<u>8.0</u>	4	32
Structure and Pressure Doors	3.5		
Interior Furnishings	1.4		
Airlock Equipment (Pumps, Storage, Etc.)	3.1		
Core/Hub/Airlock Interconnect	<u>0.7</u>	19	13
Utility Services Tunnel @ 50 kg/m × 650 m			<u>32</u>
Total Mass			<u>4,163</u>

use of ET hydrogen tanks as modular pressure shells. The following habitat description, with some minor revision, has been directly quoted from Reference 48. For the SMF orbital application, a condominium apartment tower configuration has been adopted by dividing each tank into eleven levels of circular floor plan with 2.5 m ceiling heights. A 1.8 m diameter central shaft runs the entire length of each tank, containing a dumb-waiter-like continuous belt elevator and ladders for access to all levels, plus utility service lines.

For the SMF habitat, several residential modules would be clustered around a communal core module. The lowest level (in the bottom hemispherical dome of the tank) would be used for storage and for maintenance equipment. In the residential modules, seven of the levels would be divided up into three segments surrounding the elevator shaft to provide three studio apartments. Each apartment would have 17.1 m^2 of floor space, sufficient for one or two people. Two levels (in the middle of the tank) would provide toilet, bath, and laundry facilities, while the top level (in the upper hemispherical dome) would be used as a leisure and social area.

In the core modules, the lowest level would be used for storage and maintenance. The next three levels up would provide recreational facilities. A pantry and a galley would follow on the next two levels, with the following three levels used for dining rooms. (The dining rooms would double as assembly halls and entertainment centers as well.) The two topmost levels would be used for EVA preparation, providing lockers for storage of EVA suits and facilities for recharging oxygen tanks and EVA suit repairs.

The top level and sixth level of each residential module would be connected to the corresponding levels of the core module and of each adjacent residential module. When fully occupied, each residential module (21 people) requires two ECLSS pods (12 people each). These can be nestled between adjacent hydrogen tanks, with short tunnels connecting each pod to both hydrogen tanks to provide access to the ECLSS equipment for

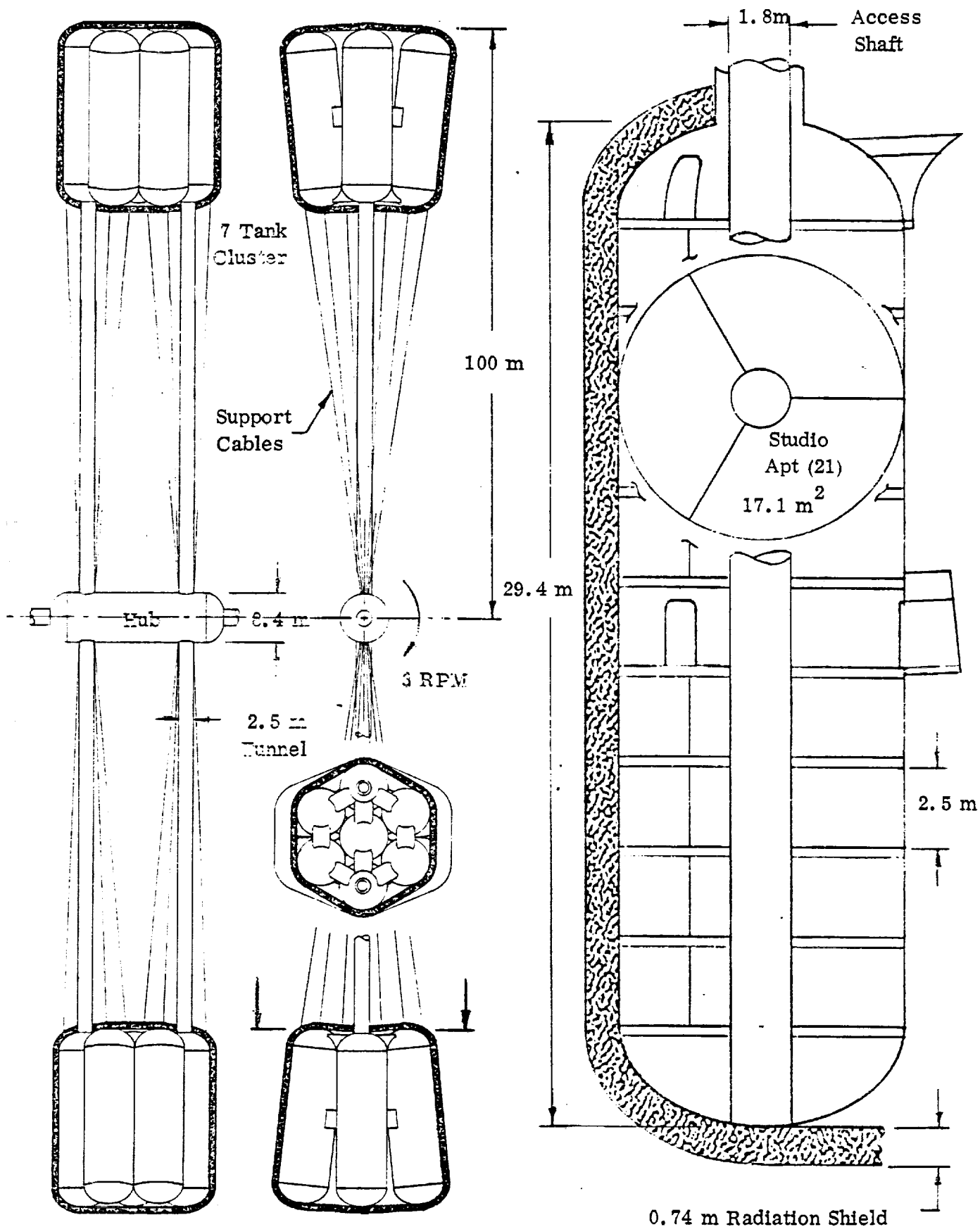

Figure 4-29. Proposed configuration for modular 1 g SMF habitat employing ET hydrogen tanks.

maintenance as well as to provide alternative emergency passageways between tanks. All passageways would be equipped with airtight hatches to permit isolation of any module.

Two identical clusters consisting of 6 residential and 1 core module can then be assembled with two 140 m long tunnels between them to form a dumbbell-like configuration. Rotation at 3 RPM provides "earth-normal gravity" at the bottom level of each module, and "0.7 gravities" at the top level. Each tunnel is stress-free, the hydrogen tanks being supported from the docking hub at the middle of each connecting tunnel by cables. Each module has an emergency air lock at the top level, with routine entry into the habitat through two airlocks in the hub. Three of these cluster pairs can be arranged in a plane and connected to a common hub module. The habitat can be further expanded by attaching another hub to the first one through a spin bearing. Spin-up can then be accomplished without expending reaction mass by counter-rotating the hubs. Elevators located within each tunnel provide efficient personnel transport from the "earth normal g" clusters to the zero g hub. The total population of a SMF habitat consisting of six habitat cluster pairs is (6 sets) (2 clusters) (6 residential modules) (21 persons/module) = 1512 people.

The general description of this habitat is contained in Figure 4-30. The data sheet sketch shows each of the 12 hexagonal tank clusters with a large radiator attached to dissipate the habitat heat load. The hub would probably be attached via the tunnel shown to separate manufacturing facilities. Habitat power would be provided from the SMF via a cable routed through this tunnel. The hub might also include a despin observation facility and docking ports.

Inert mass estimates for the 1500 person SMF habitat are contained in Table 4-40. In addition to the earth delivered mass shown in this table, 85.5 kT of shielding mass is required for habitat radiation protection. This shielding mass estimate is predicated on

Figure 4-30.
LRU ELEMENT DATA SHEET
GENERAL DESCRIPTION

<input type="checkbox"/>	Material Processing	Element Definition	<u>Large Modular 1 g SMF Habitat</u>
<input type="checkbox"/>	Transportation		<u>Constructed with ET LH₂ Tanks</u>
<input checked="" type="checkbox"/>	Infrastructure	Sizing Assumptions	<u>1500 person habitat - power supplied by independent SMF installation - radiation protection for 6 month stay time.</u>

<p>Sketch (Include Major Dimensions)</p> <p>72 Residential Modules 12 Core Modules 2 Hub Modules</p>		<p>Scaling Relationships</p> <p>Approximately linear - crew size of 750 personnel would have gross habitat weight of ~46,700 T</p> <p>*Includes 5650 T of habitat plus 85,472 T of shielding made from lunar material</p>
---	--	--

PHYSICAL CHARACTERISTICS:		Total Volume	<u>128,000 m³</u>	Delivery Vehicle
Inert Weight	<u>91,122 T*</u>	Array Area	<u>N/A</u>	
Consumable Wt.	<u>2,203 T</u>	Radiator Area	<u>30,000 m²</u>	<input type="checkbox"/> Shuttle
Gross Weight	<u>93,325 T</u>	Assembly Location		<input checked="" type="checkbox"/> SDV
Throughput	<u>N/A</u>	Initial	<u>LEO</u>	<input type="checkbox"/> HLLV
Storage Cap.	<u>N/A</u>	Final	<u>SMF Location</u>	<input checked="" type="checkbox"/> COTV
				<input type="checkbox"/> LTV

PERFORMANCE CHARACTER:		Power Req'd	<u>13.5 MW</u>	Personnel Req'ts.
Thrust Level	<u>N/A</u>	Efficiency	<u>N/A</u>	
Specific Impulse	<u>N/A</u>	Consumables	<u>2.9T/Day</u>	
Acceleration	<u>0.7 → 1.0 g</u>	Waste Heat	<u>~ 12 MW</u>	
Payload Cap.	<u>N/A</u>	Flow Rates	<u>N/A</u>	
Transfer Time	<u>N/A</u>	Useful output	<u>N/A</u>	
				<input type="checkbox"/> Support
				<input type="checkbox"/> Supervisory
				<input type="checkbox"/> Ground
				<u>1500</u> Total

Data Source(s) "Habitat and Logistic Support Requirements for Initiation of a Space Mfg Enterprises," J. P. Vajk, 1977 Ames-OAST Summer Study

Prepared by E. H. Bock Reviewed by _____

Table 4-40. 1500 person SMF habitat mass estimate

	Element Mass (T)	Qty Req'd for 1500 Persons	Total Mass (T)
Residential Module - 21 person	<u>39.9</u>	72	2,873
ET LH ₂ Tank-Stripped of Bolt-ons	14.4		
Interior Structure	13.0		
Flooring 514 m ² @ 15 kg/m ²	7.7		
Partitions 241 m ² @ 2.5 kg/m ²	0.6		
ET Wall 806 m ² @ 2.5 kg/m ²	2.0		
Central Shaft & Conveyors	0.9		
Other Structure	1.8		
Furnishings 450 kg/Person	9.5		
Other Service & Misc Equipment (8%)	3.0		
Core Module - 125 Person	<u>48.9</u>	12	587
ET LH ₂ Tank - Stripped of Bolt-ons	14.4		
Interior Structure	15.9		
Flooring 514 m ² @ 20 kg/m ²	10.3		
Partitions 120 m ² @ 2.5 kg/m ²	0.3		
ET Wall 806 m ² @ 2.5 kg/m ²	2.0		
Central Shaft & Conveyors	0.9		
Other Structure	2.4		
Furnishings ~120 kg/Person	15.0		
Other Services & Misc Equipment (8%)	3.6		
Hub Module	<u>24.0</u>	2	48
ET LH ₂ Tank - Stripped of Bolt-ons	14.4		
Interior Structure	4.2		
Furnishings	3.6		
Other Miscellaneous Equipment (8%)	1.8		
ECLSS Pods - 12 Person	<u>10.4</u>	150	1,560
Structure and Pressure Door	1.0		
Atmos Supply Control & Reconditioning	5.9	2/Res Mod + 3/Hub Mod	
Water and Waste Management	1.5		
Thermal Control Incl Radiator	4.0		
Spin Bearing Assemblies	<u>2.0</u>	3	6
Air Lock Modules	<u>8.0</u>	2	16
Radial Connection Assemblies	<u>46.7</u>	12	560
Transfer Tunnels 2 @ 4,000 kg	8.0		
Elevators 2 @ 800 kg	1.6		
Cables 7 Tanks × 5,300 kg/Tank	37.1		
Total Mass			5,650

a 6 month per year crew stay time, which requires an equivalent aluminum shield thickness of 0.74 m, based on the data contained in Table 4-35. Additional protection from solar flares can be obtained in core modules since they are surrounded by residential modules, and life support provisions (food and water) can be specifically stored to provide additional mass about the central levels on the core module.

Shielding can be most economically obtained by using lunar materials. Initially, raw lunar materials delivered for SMF processing could be stored about the habitat tank clusters. The raw material shielding would subsequently be replaced by slag obtained from lunar material processing. This slag radiation shielding should have physical properties sufficient to react the 1 g pseudogravity loads due to habitat rotation, so habitat spin-up could not be accomplished until this substitution was completed.

Summary Habitat Comparison

A per person comparison of five habitats defined in this section is contained in Table 4-41. The most massive is the 1g SMF habitat due to its pseudogravity and encompassing galactic radiation shielding. The GEO and LEO habitats are the next most massive due to their solar flare shelter requirements. The lunar base habitats are the least massive since "no charge" is made for their radiation protection which is conveniently supplied by lunar soil. The volume and area per person results are surprisingly close for all five habitats -- no specific groundrules were set to obtain this degree of conformity.

Habitat size and mass estimates for earth delivered modules are shown in Table 4-42 for LRU concepts. Shielding material source and applications are parenthetically indicated. Terrestrial material (TM) has been assumed for the LEO logistics station and LLO temporary shelter solar flare shelters. Terrestrial shielding material is included in the mass estimates shown. All other habitats employ lunar material (LM) for galactic and solar flare radiation protection. A configuration summary is included in Figure 4-31.

Table 4-41. Habitat Comparison.

Habitat Description	Volume Person (m ³)	Area Person (m ²)	Earth mass Person (T)	ET mass Person (T)	Lunar mass Person (T)	Total mass Person (T)
12-person LEO habitat with solar flare shelter	87.3 1.5	25.9 —	6.00 2.05	N/A	— —	8.05
200-person GEO habitat with solar flare shelter	87.3 1.5	25.9 —	6.00 0.06	N/A	— 7.97	14.03
12-person lunar base	85.3	25.0	2.38	N/A	*	2.38
1200-person lunar base	97.8	27.5	2.55	0.92	*	3.47
1500-person SMF habitat with galactic radiation shielding	85.3	28.7	2.94	0.83	57.0	60.77

*Habitat is covered with several meters of lunar soil available at the construction site
Lunar & SMF habitats do not include power supplies

Table 4-42. Habitat Sizing Summary.

Habitat	Lunar Resource Utilization Systems Concept		Group
	B	C & D	
LEO logistics station	75 person 604 T (TM solar flare shelter)	75 person 604 T (TM solar flare shelter)	1
LLO shelter (temporary)	12 person 52 T (TM solar flare shelter)	12 person 52 T (TM solar flare shelter)	2
Lunar base	48 person 185 T (lunar soil shielding)	400 person 2000 T (lunar soil shielding)	3
Lunar outposts (temporary)	12 person 30 T (lunar soil shielding)	Not required	2
SMF living quarters	1365 person 7853T (industrial slag shielding)	1165 person 4460 T (LM solar flare shelter)	4
GEO maintenance facility	36 person 242 T (industrial slag shielding)	Integrated with SMF living quarters	1

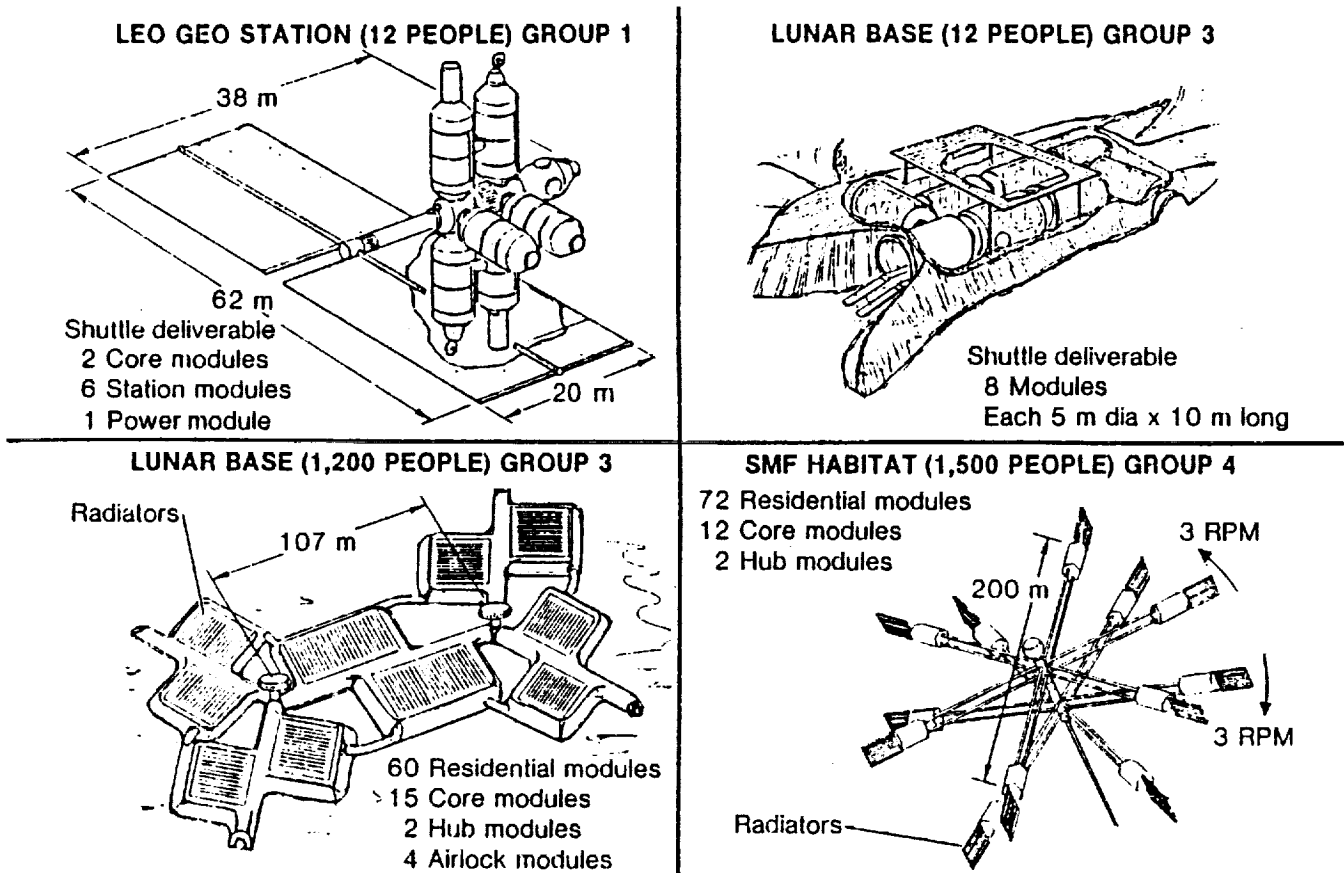

Figure 4-31. Habitat Configuration Summary.

4.5.3 Power Systems — The purpose of this section is to size and scale power systems capable of meeting the requirements of a lunar resources utilization program using technology projections for the early 1990 time period. Power systems located at the lunar equatorial surface and a geosynchronous position are assumed with a nominal electrical power output of 350 megawatts.

A survey of possible power systems was made to see which concept or concepts should be considered for this particular application. A summary of this survey is shown in Table 4-43.

For the LRU program the photovoltaic and nuclear fission Brayton cycle power systems have been selected as the two concepts for sizing and scaling. Photovoltaic devices were selected because they have demonstrated low cost and high reliability

Table 4-43. Power System Summary (1990 Technology).

	Watts/kg	Comments
Power Sources		
I Solar Devices		
Photovoltaic	200	A candidate concept
Thermionic	16	Not expected to be operational by 1990
Dynamic (Brayton)	8	" " " " " " "
II Nuclear Devices		
Radioisotope		
Thermoelectric	4	Cannot meet expected large
Thermionic	60	multimegawatt power requirements.
Dynamic (Brayton)	6	However, could be used as storage
		power or backup power source.
Fission		
Thermoelectric	4	Under-development. Needs much
Thermionic	.25	emphasis to meet requirements by 1990
Dynamic (Brayton)	17	A candidate concept
MHD	18	Present emphasis on terrestrial use.
MGD	200	A candidate concept. Depends on
		terrestrial developments.
	Thousands	
	Joules/kg	
Power Storage		
I Batteries		
Primary	200	Good reliable devices. Selection of
Secondary	120	primary and/or secondary battery
		depends on mission
II Chemicals		
Stable	10,000	Has good potential. Probably not avail-
		able by 1990.
Metastable	12,000	Available about the year 2000
III Flywheels	700	Under-development.
IV Super Conductors	10	Not competitive with other storage
		devices.
	Watts/kg	
Power Conditioning		
I Converters & Inverters	100	Good reliable devices. Not much
		improvement expected.
II Solar Array Conditioning	10,000	Under development. Available by 1983.
Power Distribution		
I Devices & Techniques for Space Application Now Under Development	—	High power technique only now being studied. Preliminary studies indicate this area will represent roughly 10% of cost and weight of most power systems.

in space power systems for the past 20 years, and probably will continue to do so with the help of significant research now going on in the terrestrial applications area. The second concept selected for sizing and scaling is a nuclear fission Brayton cycle, primarily because it is closer to being operational by 1990 than most other concepts. Also, it has the capability of supplying the multimegawatt power levels that are projected for this program, and is not subject to shutdown at night.

Nuclear Power System — A nuclear fission Brayton cycle rated at 350 megawatts electrical output is sized and shown in the attached LRU element data sheet, Figure 4-32. It represents the estimated size range needed to process lunar soil into useful products and propellants for a lunar resource utilization program in the 1990 time period. For a lunar surface installation, it is not clear what type of reactor containment structure (if any) will be required. We have assumed that if a containment dome is needed it will be constructed primarily of lunar materials. Multiple nuclear power plants of the same configuration would probably be desirable to provide back-up capability and allow down-time for maintenance and refueling. Therefore, a 350 MWe requirement might be satisfied with three 117 MWe plants.

A review of various Brayton cycle systems sized to produce from 100 to 5000 megawatts indicates a power to weight ratio range from 300 to 400 watts per kilogram. Therefore, linear scaling is assumed to be adequate in making further estimates. A weight summary for this system is included in Table 4-44.

Solar Power System — A solar power system rated at 350 megawatts of electrical power is sized for two operational locations; 1) a lunar equatorial surface operation, and 2) geosynchronous operation. Power system size differences stem from the differences in eclipse times. The lunar eclipse period occurs 50 percent of the time while the geosynchronous eclipse period occurs approximately 5 percent of the orbital period. Recent studies predict solar power systems for the 1990 time period can be sized at 100 watts per kilogram for silicon solar array with a concentration ratio

Table 4-44. Weight summary for a 350 MWe nuclear power system.

<u>System Components</u>	<u>T</u>
Reactor System	75.8
Separator	8.2
Brayton Unit	150.0
Fuel Processing	39.0
Heat Rejection	457.0
Nuclear Shield	26.0
Control Unit	8.0
Power Conditioning (2 kW/kg for converters) also (converter 30°/0 initial power)	53.0
Distribution	<u>75.0</u>
	892.0

of 1.0. Calcium solar array are projected to be 650 watts per kilogram at a concentration ratio of 2.0. A value of 200 watts per kilogram is considered achievable by 1990 and is used in our estimates.

Energy storage represents the majority of total weight for a lunar based solar array. A value of 22 watts per kilogram has been conservatively used in sizing this storage system. Predictions of 60 watts per kilogram for secondary batteries have been made if additional development funding becomes available. Ground rules and energy storage assumptions used in developing photovoltaic power system data are identified below:

Ground Rules

1. For lunar surface the duty cycle is 14 days on batteries followed by 14 days on solar panels.
2. Maximum geosynchronous occulted period is 5% of orbital period or 1.2 hours.
3. NiCd battery power-to-weight ratio is 44 watts per kg if depth of discharge (DOD) is 100%. For the lunar environment and 1990 technology, a DOD of 50% is assumed, which results in a power-to-weight ratio of 22 watts/kg.
4. System voltage is 28 VDC nominal.

Storage Capacity Required for Lunar Surface

1. 350×10^6 watts \times 24 hours \times 14 days = $117,600 \times 10^6$ W-hr
2. Battery Weight = $\frac{117,600 \times 10^6 \text{ W-hrs}}{22 \text{ W-hrs/kg}} = 5,345.45 \times 10^6 \text{ kg}$
3. A typical 110 A-hr battery weighs 105 kg
4. No. of 110 A-hr batteries required
 $= \frac{5345.45 \times 10^6 \text{ kg}}{105 \text{ kg}} = 51 \times 10^6$ batteries
5. Energy required to recharge batteries:
Assume $T = 10^\circ\text{C}$ and C/D ratio = 1.05
Energy Required = $117,600 \times 10^6 \text{ W-hr} \times 1.05$
 $= 123,480 \times 10^6 \text{ W-hr}$
Solar Array Size = $350 + \frac{123,480}{24 \times 14} = 718 \text{ MW}_e$

Storage Capacity Required For Geosynchronous Orbit

1. Battery discharge time is 5% of 24 hour period
 $= 1.2$ hours
2. Power required is 350×10^6 watts \times 1.2 hours
 $= 420 \times 10^6$ watt-hrs
3. Battery weight = $\frac{420 \times 10^6 \text{ W-hrs}}{22 \text{ W-hrs/kg}} = 19.09 \times 10^6 \text{ kg}$
4. No. of 110 A-hr batteries required
 $= \frac{19.09 \times 10^6 \text{ kg}}{105 \text{ kg}} = 180 \times 10^3$ batteries
5. Energy required to recharge batteries
 $420 \times 10^6 \text{ W-hrs} \times 1.05 = 441 \times 10^6 \text{ W-hrs}$
Solar array size = $350 + \frac{441}{(24-1.2)} = 370 \text{ MW}_e$

A weight summary for the two solar array designs is shown in Table 4-45.

Table 4-45. Weight summary for a 350 MWe solar power system.

System Components	Lunar (kg × 10 ⁶)	Geosynchronous (kg/10 ⁶)
(1) Solar Panel (200 W/kg)	3.6	1.85
(2) Transmission	0.2	0.08
(3) Distribution	0.4	0.15
(4) Power Conditioning (For 20 MWe) (At 2KW/kg)	0.2	0.08
(5) Control	0.03	0.01
(6) Storage Batteries	<u>5,345.5</u>	<u>19.09</u>
Total Weight	5,350	21.26

As is obvious from data in Table 4-45, the mass of storage batteries dominates the solar power system mass for applications on the lunar surface and in geosynchronous orbit. Even a factor of three improvement in battery mass to account for our conservative estimate does not significantly reduce the overwhelming influence of battery weight on the total system. Due to the extreme penalty associated with energy storage for a lunar surface photovoltaic system, use of solar power was limited to orbital applications such as the SMF. Figure 4-33 describes a photovoltaic power system sized for geosynchronous orbit. Power plant estimates for each LRU concept were obtained from the 350 MWe systems in Tables 4-44 and 4-45 by linear scaling. Nuclear Brayton power supplies were selected for the lunar base in all three concepts to permit full time operations without incurring a substantial energy storage penalty. Photovoltaic systems were selected for use in geosynchronous orbit, but high power usage during occulted periods was restricted to allow significant reductions in energy storage capacity.

Power System Sizing Summary — Power requirements for facility sizing were obtained from start-up data contained in Section 4.8, and are shown in Table 4-46. Plant

facility requirements for meeting these power needs are summarized in Table 4-47. As previously discussed, in-space power plants are photovoltaic while lunar surface facilities are nuclear. Possible lunar power plant alternatives include photovoltaic systems with storage devices much more efficient than existing batteries, or which utilize orbital reflectors to reduce storage requirements.

Table 4-46. LRU Concept Power Requirements.

		<u>Power Requirement (MW)</u>	<u>B</u>	<u>C</u>	<u>D</u>
<u>LUNAR SURFACE</u>	Mining and Beneficiation		0.02	0.04	0.08
	Material Processing	}	1.32	436.0	885.0
	Manufacturing			55.89	68.3
	Transportation		39.3	--	--
	Habitat		<u>0.5</u>	<u>3.6</u>	<u>3.6</u>
	TOTAL		41.14	495.5	957.0
<u>SPACE</u>	Material Processing		331.01	--	--
	Manufacturing (except solar cells)		39.82	6.98	6.98
<u>MANUFACTURING</u>	Solar Cell Manufacturing		239.04	239.04	239.04
<u>FACILITY</u>	Habitat		<u>13.5</u>	<u>10.5</u>	<u>10.5</u>
	TOTAL		683.4	256.5	256.5

Table 4-47. Power Plant Sizing

	LRU Concept		
	B	C	D
Lunar surface	— Nuclear Brayton —		
Power reqd (MW)	50	500	960
Plant mass (T)	254	1275	2450
U238 resupply (T/yr)	0.08	0.79	1.51
SMF	— Photovoltaic —		
Power reqd (MW)	650	260	260
Plant mass (T)	5030	2015	2015

Figure 4-32:
LRU ELEMENT DATA SHEET
GENERAL DESCRIPTION

<input type="checkbox"/>	Material Processing	Element Definition	<u>Nuclear Power System</u>
<input type="checkbox"/>	Transportation		<u>Located on Lunar Surface</u>
<input checked="" type="checkbox"/>	Infrastructure	Sizing Assumptions	<u>Sizing based on a nuclear satellite</u>

5 gigiwatt conceptual design.

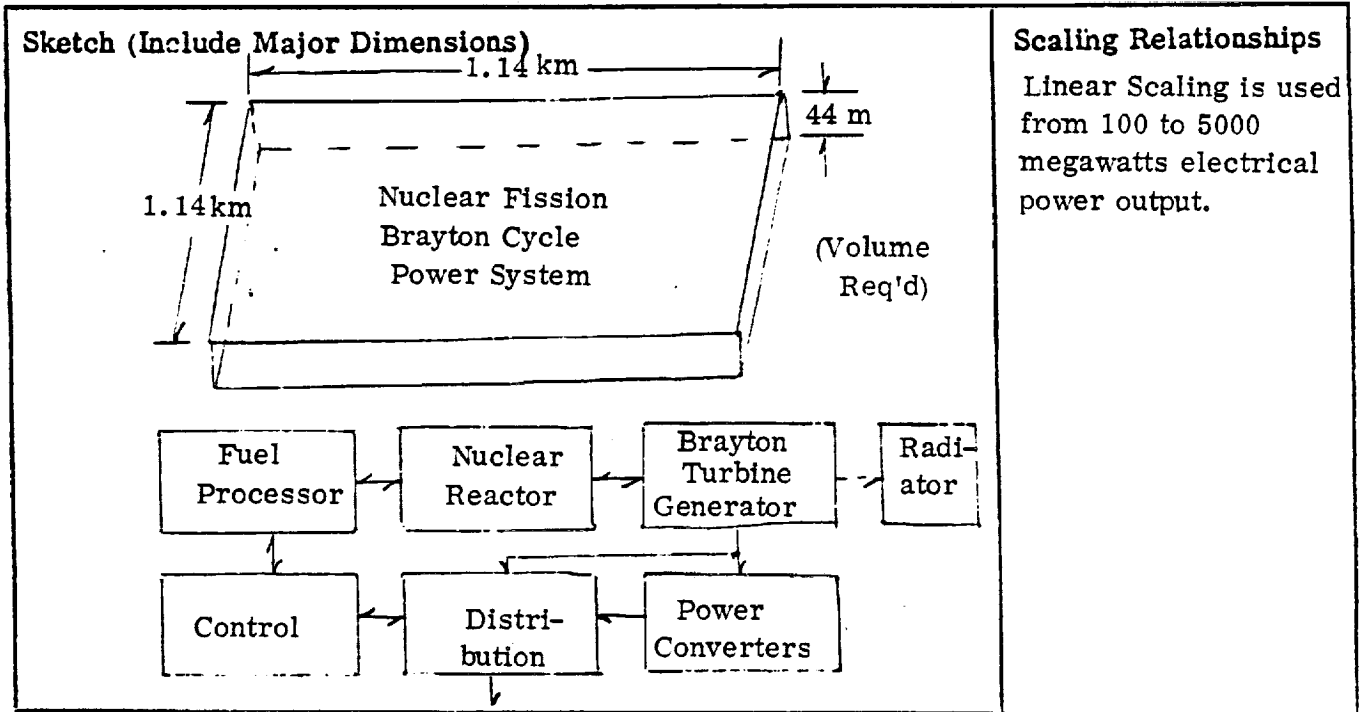

PHYSICAL CHARACTERISTICS:

Inert Weight	<u>N/A</u>
Consumable Wt.	<u>1.5 kg/Day U238</u>
Gross Weight	<u>0.89 × 10⁶ kg</u>
Throughput	<u>N/A</u>
Storage Cap.	<u>N/A</u>

Total Volume	<u>57 × 10⁶ m³</u>
Array Area	<u>N/A</u>
Radiator Area	<u>0.1 × 10⁶ m²</u>
Assembly Location	<u>Earth</u>
Initial	<u>Earth</u>
Final	<u>Lunar Surface</u>

Delivery Vehicle

<input type="checkbox"/>	Shuttle
<input checked="" type="checkbox"/>	SDV
<input type="checkbox"/>	HLLV
<input checked="" type="checkbox"/>	COTV
<input checked="" type="checkbox"/>	LTV

PERFORMANCE CHARACTER:

Thrust Level	<u>N/A</u>
Specific Impulse	<u>N/A</u>
Acceleration	<u>N/A</u>
Payload Cap.	<u>N/A</u>
Transfer Time	<u>N/A</u>

Power Req'd	<u>1.1 × 10⁹ W (Thermal)</u>
Efficiency	<u>31 %</u>
Consumables	<u>8 kg/Day (Reprocessed)</u>
Waste Heat	<u>760 × 10⁶ W (Thermal)</u>
Flow Rates	<u>N/A</u>
Useful output	<u>350 × 10⁶ W (Electric)</u>

Personnel Req'ts.

<input type="checkbox"/>	Primary
<input type="checkbox"/>	Support
<input type="checkbox"/>	Supervisory
<input type="checkbox"/>	Ground
<input type="checkbox"/>	Total

Data Source(s) Atomics International. "A 5 GW nuclear satellite power system conceptual design."

Prepared by D. E. Creed

Reviewed by _____

Figure 4-33.
LRU ELEMENT DATA SHEET
GENERAL DESCRIPTION

<input type="checkbox"/>	Material Processing	Element Definition <u>Photovoltaic Power System.</u>
<input type="checkbox"/>	Transportation	<u>Solar Panel Power system at geosynchronous altitude</u>
<input checked="" type="checkbox"/>	Infrastructure	Sizing Assumptions <u>Solar Panel sizing based on 200 watts/kg and 15% efficiency. Batteries rated at 22 watts/kg.</u>

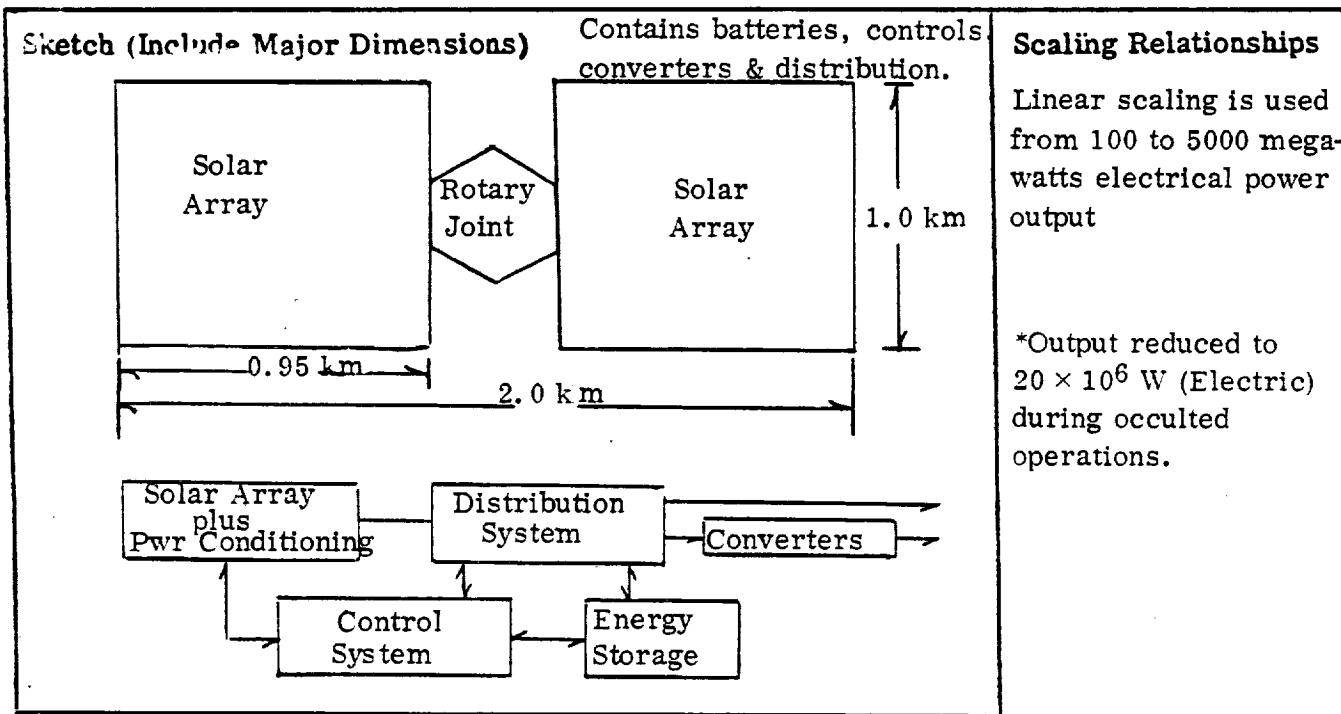

PHYSICAL CHARACTERISTICS:

Inert Weight	<u>N/A</u>	Total Volume	<u>N/A</u>	Delivery Vehicle <input type="checkbox"/> Shuttle <input checked="" type="checkbox"/> SDV <input type="checkbox"/> HLLV <input checked="" type="checkbox"/> COTV <input type="checkbox"/> LTV
Consumable Wt.	<u>N/A</u>	Array Area	<u>1.9×10^6 m²</u>	
Gross Weight	<u>3.42×10^6 kg</u>	Radiator Area	<u>N/A</u>	
Throughput	<u>N/A</u>	Assembly Location	<u>Low earth orbit</u>	
Storage Cap.	<u>N/A</u>	Initial	<u>Geosynchronous</u>	
		Final	<u>Geosynchronous</u>	

PERFORMANCE CHARACTER:

Thrust Level	<u>N/A</u>	Power Req'd	<u>Solar Energy</u>	Personnel Req'ts. <input type="checkbox"/> Primary <input type="checkbox"/> Support <input type="checkbox"/> Supervisory <input type="checkbox"/> Ground <input type="checkbox"/> Total
Specific Impulse	<u>N/A</u>	Efficiency	<u>15%</u>	
Acceleration	<u>N/A</u>	Consumables	<u>N/A</u>	
Payload Cap.	<u>N/A</u>	Waste Heat	<u>N/A</u>	
Transfer Time	<u>N/A</u>	Flow Rates	<u>N/A</u>	
		Useful output	<u>350×10^6 W (Electric)*</u>	

Data Source(s) Rockwell & Boeing, "Solar Power Satellite Studies."

Prepared by D. E. Creed Reviewed by _____

4.6 LRU TRANSPORTATION ELEMENT DEFINITION

Definition of transportation system vehicles and the development of associated cost information is a key study ingredient. This data is especially important since it is potential transportation cost reductions predicated on lower lunar to GEO transfer energy requirements that suggest use of lunar-derived materials for constructing GEO satellites.

The idea of using lunar materials for in-space construction was suggested by the lower energy requirements needed to transport material from the lunar surface to a point in deep space, as compared with delivery from the earth's surface to the same point. This energy difference has been expressed as gravity wells (4,000 miles deep for earth, 180 miles deep for the moon), and as the ratio of potential energy per unit mass for earth and moon, i. e., 22:1. These ratios express relative energy requirements to escape the gravitational influence of the earth and moon. The point of interest in space for the LRU study is geosynchronous orbit, which remains within the gravitational influence of both bodies. Another method of expressing the relative transportation requirements is by ΔV , the velocity increment which must be imparted to transfer payload from one point to another. The ΔV 's shown in Figure 4-34 have been determined by realistically assuming that two vehicles should be used from each body's surface to GEO, and that payload transfer from one vehicle to the other will occur in a low stable orbit. Based on these assumptions the energy ratio to geosynchronous orbit is approximately 12:1.

Another method of expressing this energy ratio is as propellant mass requirements for delivering an equivalent payload. In this case the propellant mass is strongly influenced by the vehicle propulsion systems selected. Efficient systems (high Isp) will have lower propellant requirements than inefficient systems. To demonstrate this effect, propellant mass ratios were calculated for the three LRU concepts developed by this study. Earth launch (SDV with chemical propellants) and in-space transfer between LEO and GEO, LLO and GEO, and L_2 and GEO (ion electric CCTV with

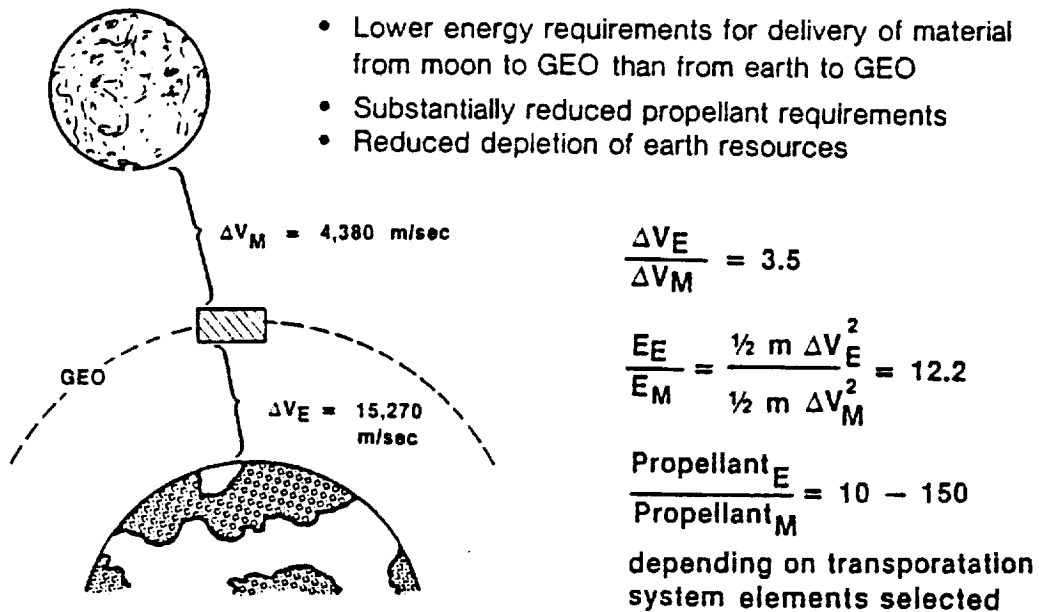

Figure 4-34. LRU transportation benefit.

oxygen propellant) were common to all three concepts. The vehicles employed for lunar surface to LLO transfer differ; electrically driven catapult for Concept B, conventional hydrogen/oxygen for Concept C, and aluminum/oxygen rocket for Concept D. The earth/lunar propellant delivery ratios for these three concepts are; LRU Concept B 146:1, LRU Concept C 27:1, and LRU Concept D 10.5:1. An important ancillary criterion is propellant origin. Concept C has a higher earth/lunar propellant delivery ratio than Concept D, but some of C's lunar escape propellant must come from earth (hydrogen), while all of D's lunar escape propellant is derived from lunar resources.

Transportation options are characterized by mission geometry (surface site locations, space facility orbits, and transfer modes) and the launch and transfer vehicles selected. All earth and lunar sites, orbits, and transfer modes have been selected for maximum compatibility with the particular transportation option, considering launch/maneuver frequency and energy requirements. Preliminary site selections, largely based on current SPS and LRU literature, are shown in Table 4-48. Energy

Table 4-48. Sites assumed for definition of LRU Transportation Systems.

Earth Launch Site	KSC
LEO	Circular, 477.8 km altitude, 31.606 deg inclination
GEO	Circular, 35786 km altitude, 0.0 deg inclination
LLO	Circular 50 km altitude, lunar equatorial (≈ 5 deg inclination to ecliptic)
Lunar Base	Near lunar equator, 33.1 deg east longitude
SMF	Concept C&D at GEO Concept B at 2:1 resonance orbit
Raw Material Catch Site	Lunar libration point L_2

requirements in the form of the ideal vehicle ΔV required for transfer between these sites and/or orbits are contained in Table 4-2 on page 4-13. Definitions of vehicle stage efficiencies are also included in Table 4-2.

Figure 4-35 depicts the seven principal transportation routes and the vehicles required for each LRU concept. A total of 10 basic vehicle types are identified to satisfy these requirements.

The first step in defining transportation elements is vehicle sizing. This is accomplished by considering interrelated parameters of vehicle payload capacity, launch frequency, and total fleet requirements. The given information is total annual payload for each transfer leg to support construction of one 10 GW SPS. This information is contained in Figures 4-4, 4-6, and 4-7 on pages 4-18 through 4-22 for LRU Concepts B, C and D respectively. The annual payload is calculated by multiplying the quantities/10 units of SPS shown in these figures by one tenth the SPS mass, which is equal to 9,838 T for an SPS constructed using 89.6 percent lunar materials. Vehicle and fleet sizing (Section 4.6.1) is followed by individual vehicle descriptions in

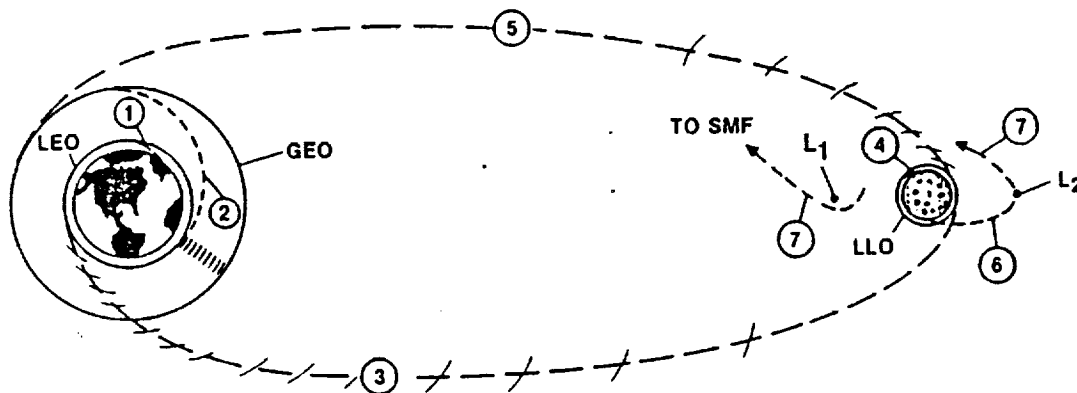

	Cargo Transfer		Personnel Transfer	
	Vehicle	LRU Concept	Vehicle	LRU Concept
① EARTH — LEO	SDV	B C D	SS or SDV	B C D
② LEO — GEO or SMF	COTV	B C D	POTV	B C D
③ LEO — LLO	COTV	B C D	POTV	B C D
④ LLO — LUNAR SURFACE	PLTV (Down)	B	PLTV	B
	LTV	C	LTV	C
	LDR	D	LDR	D
⑤ LLO — GEO or SMF	COTV	C D	POTV	B C D
⑥ LUNAR SURFACE — L ₂	Mass driver	B	POTV (LLO to L ₂ maintenance)	B
⑦ L ₂ — SMF	Catcher/TT	B		

Figure 4-35. Transportation Routes and Vehicle Requirements.

Section 4.6.2.

4.6.1 Vehicle and Fleet Sizing - Tables 4-49 through 4-52 present vehicle and fleet size information for each transportation element within the earth baseline and each LRU option. As noted, this information is predicated on the construction of one SPS per year; considerations associated with other construction rates are discussed later.

The fleet and vehicle size requirements have been derived from a variety of parameters with the primary driver being the material transportation flow requirements presented in Section 4.2. For Concept A, Table 4-49, the vehicle sizes were set by Reference 55, but the fleet sizes were adjusted on the basis of the material flow requirements. In addition, Reference 55 included spares in its fleet sizing, while Table 4-49, as well as the other LRU concept tables, does not.

Certain vehicles associated with the lunar resource utilization options are sized by the basic assumptions of the LRU concept. For instance, the use of an SDV based on a cargo-only version of the current Shuttle system combined with the B-17E booster sets the size of that vehicle. In the same manner, the use of the current Space Shuttle with the 75 passenger module and the use of that module throughout for personnel transfer, dictates the size of the POTV and PLTV. The remaining vehicles have been sized by guidelines that are somewhat more arbitrary; i. e. , minimum of two trips per year on COTV legs, maximum of 6000 thrusters per COTV, etc. These assumptions, which apply to Tables 4-49 through 4-52 , are as follows:

1. One SPS per year construction rate.
2. Concept A, Table 4-49, vehicle sizes are set by Reference 55, but the fleet sizes are adjusted for material flow requirements presented in Figure 4-2.
3. No spares.
4. SDV size set by Appendix E Section E. 2, Volume III.
5. All personnel transfers are accomplished with the 75 passenger module designed to fit within the Shuttle payload bay.
6. Minimum of two trips per year on each COTV leg.
7. Maximum of 6000 thrusters per COTV.
8. LTV and LDR sized for 1 launch per earth day.
9. No unscheduled down time except mass driver catapult which allows 10% unscheduled maintenance for the solar powered version, and 25% scheduled and unscheduled maintenance for the nuclear powered version.
10. COTV attitude control propellant is 12.5% of main propellant, does not contribute to ΔV , and is consumed at a steady rate.

Effect of Construction Rate

Changes in the assumed SPS construction rate from one per year will impact the different transportation elements in various ways, which depend on the assumptions utilized initially. Where the vehicle size has been set and full utilization is occurring, such as

Table 4-49. Concept A Vehicle and Fleet Sizing.

Item Leg	Vehicle	Vehicle Capacity (T or People)	Quant /10 Units of SPS	Total Quant/SPS (T or People)	Flights /SPS	Trip Days Include Turnaround	Recm'd Fleet Size	Notes
Cargo Earth → LEO	HLLV	424T	15.14	147,691T	349	5	5	Does not agree with 391 flights specified in JSC document (Reference 1)
Segments + LS LEO → GEO	COTV	1 Segment 8700T × 6 23,700T × 2	10.005	97,599T	8	<180	See Note	One for each segment one way only, not reused
Personnel Earth ↔ LEO	SS	75	540/rotat	2160	32	15	2	8 per rotation
Personnel LEO ↔ GEO	POTV	75	60/rotat	240	4	7	1	1 per rotation

1 SP = 97,550T
1 SPS/Year Rate

Table 4-50. Concept B Vehicle and Fleet Sizing.

Item Leg	Vehicle	Vehicle Capacity (T or People)	Quant /10 Units of SPS	Total Quant/SPS (T or People)	Flights /SPS	Trip Days Include Turnaround	Recm'd Fleet Size	Notes
Cargo Earth LEO	SDV	200.9T	1.38	13,576T	68	7	2	
Prop+LS LEO → GEO	COTV ₁	*	0.006					*Eliminate this vehicle, move propellant and life support supplies via COTV ₃ and COTV ₄
Empty GEO → LEO	COTV ₁	*	0					
H ₂ +LS LEO → LLO	COTV ₂	118T	.024	236T	2	<180	2	240 Thrusters/Vehicle
Empty LLO → LEO	COTV ₂					<180		
SPS+Chem +IS+H ₂ LEO → SMF	COTV ₃	6578T	1.337	13,153T	2	<180	2	~2740 Thrusters/Vehicle
O ₂ SMF → LEO	COTV ₃	3260T	0.67	6,591T		<180		
SPS+O ₂ +LS +H ₂ SMF → GEO	COTV ₄	32,865T	70.022	98,596T	3	<180	3	~5880 Thrusters/Vehicle
Empty GEO → SMF	COTV ₄					<180		This COTV may be sized to move even smaller segments if desired
Personnel Earth ↔ LEO	SS	75		3042/yr	41	14	2	46 Shuttle flights req'd to match summation of POTV flights.

Table 4-50. Concept B Vehicle and Fleet Sizing (Continued).

Item Leg	Vehicle	Vehicle Capacity (T or People)	Quant /10 Units of SPS	Total Quant/SPS (T or People)	Flights /SPS	Trip Days Include Turnaround	Recm'd Fleet Size	Notes
Personnel LEO↔GEO	POTV ₁	75	36/rotat	216/yr	6	7	1	1 per rotation
Personnel LEO↔SMF	POTV ₂	75	1365/rotat	2730/yr	38	9	1	19 per rotation
Personnel LEO↔LIO	POTV ₃	75	48/rotat	96/yr	2	9	1	1 per rotation
Personnel LIO↔Moon	PLTV	≥48	48/rotat	96/yr	2	7	1	1 per rotation (Use 75 man module)
Lunar Soil L ₂ →SMF	TT	85,000T	17.15	168,722T	2	7	1	
Catcher Propellant SMF→L ₂	TT	85,600		~10,000T				
Lunar Soil Moon→L ₂	Mass Driver Catapult	~2.5 kg/BAG (~1.4 kg/BAG)*	17.15	168,722T	67.5 × 10 ⁶ BAGS (120.5 × 10 ⁶)*	NA	1	Solar powered catapult assume 320 hr operation every 28 days *(Nuclear) Full time operation
Lunar Soil L ₂	Mass Catcher	85,000T	17.15	168,722T	2	NA	1	

1 SPS = 98,380T
1 SPS/Year Rate

Table 4-51. Concept C Vehicle and Fleet Sizing.

Item Leg	Vehicle	Vehicle Capacity (T or People)	Quant /10 Units of SPS	Total Quant/SPS (T or People)	Flights /SPS	Trip Days Include Turnaround	Recm'd Fleet Size	Notes
Cargo Earth → LEO	SDV	200.9T	2.41	23,710T	118	7	3	
SPS+LS+H ₂ LEO → GEO	COTV ₁	5,293T	1.076	10,586T	2	<180	2	~1120 Thrusters/Vehicle
Empty GEO → LEO	COTV ₁					<180		
Chem+LS +H ₂ LEO → LLO	COTV ₂	2,540T	1.291	12,701T	5	<180	5	~5512 Thrusters/Vehicle
O ₂ LLO → LEO	COTV ₂	1987T	1.010	9,936T		<180		
SPS+O ₂ LLO → GEO	COTV ₃	29,678T	9.050	89,034T	3	<180	3	~5400 Thrusters/Vehicle
Empty GEO → LLO	COTV ₃					<180		
SPS+O ₂ Moon ↔ LLO	LTV	310T	11.41	112,252T	365	7	7	Down payload capability of 10% × Up payload for IS, Chem & Personnel
Personnel Earth ↔ LEO	SS	75		3930/yr	53	14	2	56 Shuttle flights required to match summation of POTV flights
Personnel LEO ↔ GEO	POTV ₁	75	200/rotat	1200/yr	18	7	1	3 per rotation
Personnel LEO ↔ LLO	POTV ₂	75	1365/rotat	2730/yr	38	9	1	19 per rotation

1 SPS = 98,380T

1 SPS/Year Rate

Table 5-52. Concept D Vehicle and Fleet Sizing.

Item Leg	Vehicle	Vehicle Capacity (T or People)	Quant /10 Units of SPS	Total Quant/SPS (T or People)	Flights /SPS	Trip Days Include Turnaround	Recm'd Fleet Size	Notes
Cargo Earth→LEO	SDV	200.9 T	1.54	15,151 T	76	7	2	
SPS+LS+H ₂ LEO→GEO	COTV ₁	5293T	1.076	10,586T	2	<180	2	≈1120 Thrusters/Vehicle
Empty GEO→LEO	COTV ₁							
Chem+LS +H ₂ LEO→LLO	COTV ₂	1,381T	0.421	4,142T	3	<180	3	≈5500 Thrusters/Vehicle
O ₂ LLO→LEO	COTV ₂	2,328T	0.71	6,985T		<180		
SPS+O ₂ LLO→GEO	COTV ₃	29,678T	9.05	89,034T	3	<180	3	≈5400 Thrusters/Vehicle
Empty GEO→LLO	COTV ₃					<180		
SPS+O ₂ Moon↔LLO	LDR	300T	10.99	108,120T	365	7	7	Down payload capability of 10% × Up payload for L. S. , Chem & Personnel
Personnel Earth↔LEO	SS	75		3930/yr	53	14	2	56 Shuttle flights required to match summation of POTV flights
Personnel LEO↔GEO	POTV ₁	75	200/rotat	1200/yr	18	7	1	3 per rotation
Personnel LEO↔LLO	POTV ₂	75	1365/rotat	2730/yr	38	9	1	19 per rotation

1 SPS = 98,380T
1 SPS/Year Rate

the HLLV and SDV, fleet size may be directly ratioed to construction rate. Where vehicle size is set but under utilization is occurring, such as the Concept A POTV, the construction rate may be increased to some extent without a change in fleet size.

In cases where the vehicle/fleet have been sized by more arbitrary guidelines, it would be necessary to re-evaluate the guidelines. For example, in Concept C, if the construction rate were doubled, COTV₁ would double in size with the same fleet requirement, COTV₃ would probably remain the same size with a doubled fleet, but for COTV₂ strong consideration should be given to relaxing the 6000 thruster limit. Similarly, the LTV Concept C or LDR Concept D fleets would be doubled to fourteen for a construction rate of 2 per year. If the rate were increased to 3 per year, the fleet would probably be maintained at fourteen, while vehicle size was increased to approximately 450 T payload capacity.

4.6.2 Vehicle Descriptions - The following text and LRU Element Data Sheets include descriptions of the various transportation elements required by each of the SPS construction options. In some cases the vehicles are well defined in current literature and their description has been obtained from these sources. When existing published information was not suitable for LRU element definition, the data required was developed by study personnel.

a. Heavy Life Launch Vehicle (HLLV)

The heavy lift launch vehicle required by Concept A would be a totally new vehicle developed for this purpose. The vehicle's general characteristics are shown in Figure 4-36. The HLLV is a two-stage fully reusable vehicle. The booster incorporates airbreathing engines for flyback capability to permit its return to the launch site, while the Orbiter glides back to the launch site.

b. Personnel Launch Vehicle (PLV)

The personnel launch vehicle required by Concept A is based upon the current Space Shuttle Transportation System (SSTS). Vehicle general characteristics are shown in Figure 4-37.

Figure 4-36.
LRU ELEMENT DATA SHEET
GENERAL DESCRIPTION

<input type="checkbox"/>	Material Processing	Element Definition	<u>Heavy Lift Launch Vehicle (HLLV)</u>
<input checked="" type="checkbox"/>	Transportation		
<input type="checkbox"/>	Infrastructure	Sizing Assumptions	<u>400 T Payload to LEO - Two Stage fully reusable</u>

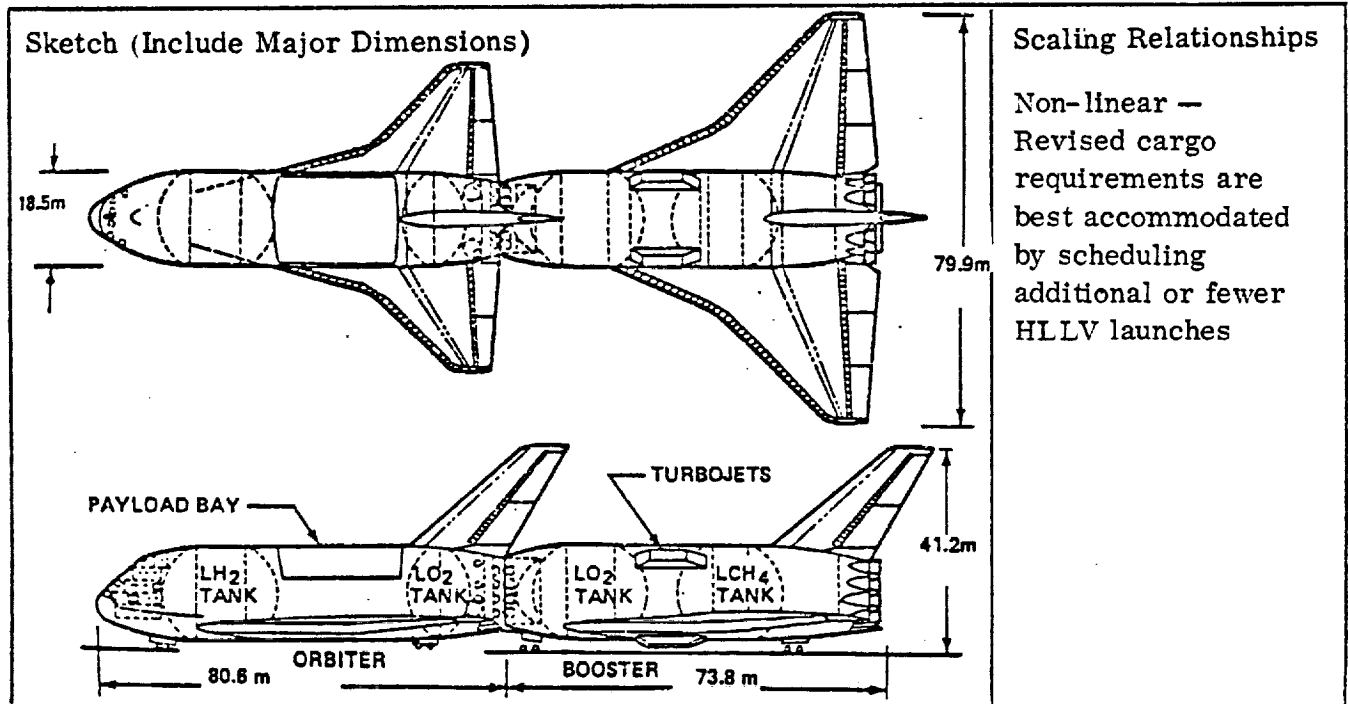

PHYSICAL CHARACTERISTICS:		Total Volume	5200 m ³	Delivery Vehicle	
Inert Weight	<u>~1,400T</u>	Array Area	<u>N/A</u>	<input type="checkbox"/>	Shuttle
Consumable Wt.	<u>~9,200T</u>	Radiator Area	<u>N/A</u>	<input type="checkbox"/>	SDV
Gross Weight	<u>11,040T</u>	Assembly Location		<input type="checkbox"/>	HLLV
Throughput	<u>N/A</u>	Initial	<u>Earth</u>	<input type="checkbox"/>	COTV
Storage Cap.	<u>N/A</u>	Final	<u>Earth</u>	<input type="checkbox"/>	LTV
PERFORMANCE CHARACTER:		Power Req'd	<u>N/A</u>	Personnel Req'ts.	
Thrust Level	<u>177 × 10⁶ / 29 × 10⁶ N</u>	Efficiency	<u>N/A</u>	<input checked="" type="checkbox"/>	6 Primary
Specific Impulse	<u>3473/4462 N-s/kg</u>	Consumables	<u>LO₂/CH₄ & LO₂/LH₂</u>	<input type="checkbox"/>	Support
Acceleration	<u>≤3g</u>	Waste Heat	<u>N/A</u>	<input type="checkbox"/>	Supervisory
Payload Cap.	<u>424T</u>	Flow Rates	<u>N/A</u>	<input type="checkbox"/>	Ground
Transfer Time	<u>~1 hr</u>	Useful output	<u>N/A</u>	<input checked="" type="checkbox"/>	6 Total

Data Source(s) Aviation Week 17 July 1978/1-25-78 JSC SPS Concept Evaluation Program/
Preliminary Baseline Concept

Prepared by C. W. Shawl Reviewed by _____

Figure 4-37.
LRU ELEMENT DATA SHEET
GENERAL DESCRIPTION

<input type="checkbox"/>	Material Processing	Element Definition	<u>Personnel Launch Vehicle (PLV)</u>
<input checked="" type="checkbox"/>	Transportation	_____	
<input type="checkbox"/>	Infrastructure	Sizing Assumptions	<u>Current Orbiter, smaller ET, LO₂/CH₄ Series Burn Booster. Orbiter modified as 'Bus'</u>

<p>Sketch (Include Major Dimensions)</p>	<p>Scaling Relationships</p> <p>Non-linear — Revised personnel requirements are best accommodated by scheduling additional or fewer PLV launches</p>
--	--

PHYSICAL CHARACTERISTICS:

Inert Weight	<u>265T</u>	Total Volume	<u>300 m³</u>	Delivery Vehicle <input type="checkbox"/> Shuttle <input type="checkbox"/> SDV <input type="checkbox"/> HLLV <input type="checkbox"/> COTV <input type="checkbox"/> LTV
Consumable Wt.	<u>~2074T</u>	Array Area	<u>N/A</u>	
Gross Weight	<u>2375T</u>	Radiator Area	<u>N/A</u>	
Throughput	<u>N/A</u>	Assembly Location		
Storage Cap.	<u>N/A</u>	Initial	<u>Earth</u>	
		Final	<u>Earth</u>	

PERFORMANCE CHARACTER:

Thrust Level	<u>35×10⁶/6.3×10⁶ N</u>	Power Req'd	<u>N/A</u>	Personnel Req'ts. <input checked="" type="checkbox"/> 4 Primary <input type="checkbox"/> Support <input type="checkbox"/> Supervisory <input type="checkbox"/> Ground <input type="checkbox"/> Total
Specific Impulse	<u>3473/4462 N-s/kg</u>	Efficiency	<u>N/A</u>	
Acceleration	<u>≤3g</u>	Consumables	<u>LO₂/CH₄ & LO₂/LH₂</u>	
Payload Cap.	<u>36T</u>	Waste Heat	<u>N/A</u>	
Transfer Time	<u>~1 hr</u>	Flow Rates	<u>N/A</u>	
		Useful output	<u>N/A</u>	

Data Source(s) 1-25-78 JSC SPS Concept Evaluation Program/Preliminary Baseline Concept

Prepared by C. W. Shawl Reviewed by _____

The following modifications to the current SSTS are required for its use as the PLV:

- The two solid rocket boosters (SRB's) are replaced by a new single liquid propellant (LO_2/CH_4) booster. This booster would operate in a series burn mode rather than the parallel burn mode used with the SRBs. The booster would be reusable, following its ballistic return and recovery.
- A smaller external tank for the Orbiter LO_2/LH_2 propellants would be used.
- The Orbiter would be modified to serve as a 'bus' by use of a 75 passenger payload bay module. This module would be transferrable to the POTV for transport to GEO. (See Paragraph e.)

c. Personnel Orbital Transfer Vehicle (POTV)

The personnel orbital transfer vehicle required by Concept A would be a totally new vehicle developed for this purpose. The vehicle general characteristics are shown in Figure 4-38.

The POTV is a two stage, fully reusable LO_2/LH_2 , vehicle using "common" stages; i. e., the structure and tankage are identical, with the first stage having four engines and the second stage two engines. In operation, the first stage injects the vehicle into a highly elliptical transfer orbit; the first stage retains sufficient propellant to recircularize itself at low earth orbit (LEO). The second stage completes the transfer to geosynchronous earth orbit. It also carries sufficient propellant for transfer back to and recircularization at LEO. The 75 passenger payload bay module mentioned in the personnel launch vehicle section would be transferred complete from the PLV to the POTV for transport to GEO. (See Paragraph e.)

d. Cargo Orbit Transfer Vehicle (COTV)

The cargo orbit transfer vehicle utilized for Concept A is a "payload powered" ion electric type; i. e., electrical power for the ion thrusters would come from partially deployed solar cell arrays on the SPS segments. The general characteristics of the

Figure 4-38.
LRU ELEMENT DATA SHEET
GENERAL DESCRIPTION

<input type="checkbox"/>	Material Processing	Element Definition	<u>Personnel Orbital Transfer Vehicle</u>
<input checked="" type="checkbox"/>	Transportation		<u>(POTV)</u>
<input type="checkbox"/>	Infrastructure	Sizing Assumptions	<u>LEO → GEO Transfer of 75 passengers</u>
			<u>Fully reusable vehicle, with propellant depot in LEO only</u>

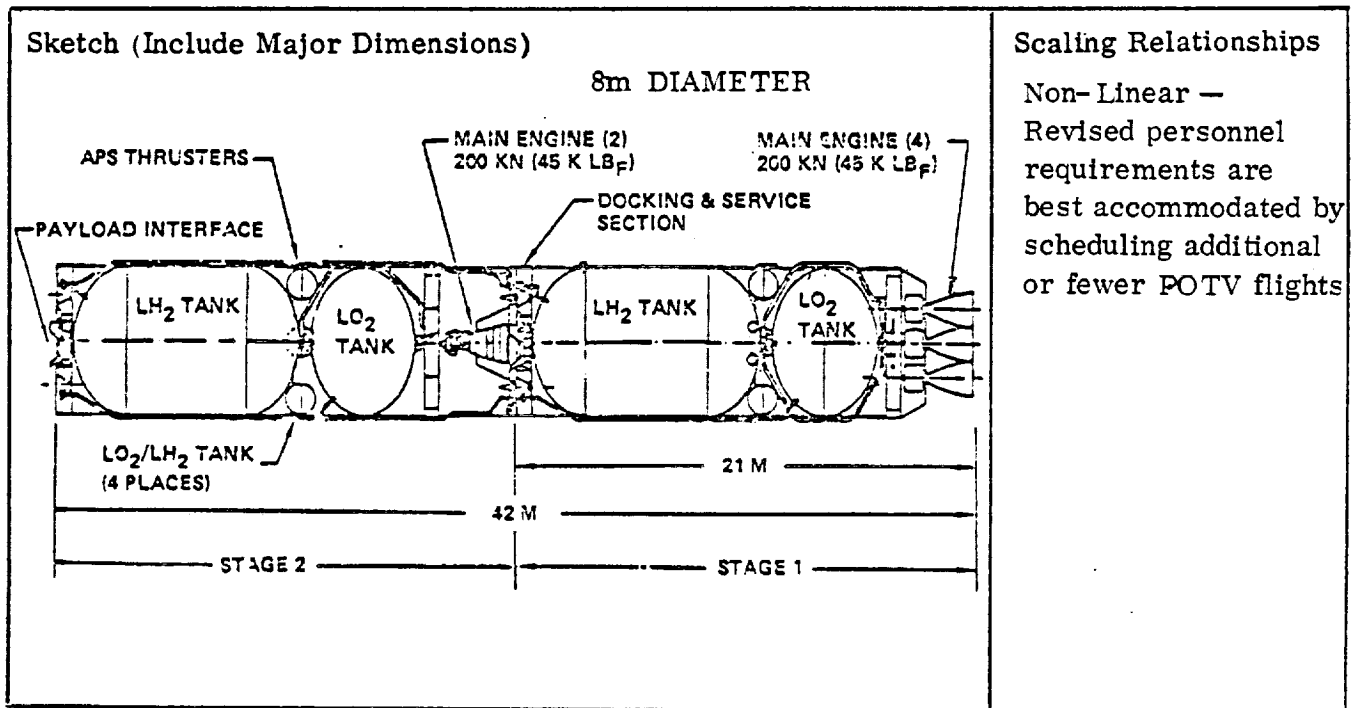

PHYSICAL CHARACTERISTICS:

Inert Weight	<u>34.5T</u>
Consumable Wt.	<u>460.5T</u>
Gross Weight	<u>560T</u>
Throughput	<u>N/A</u>
Storage Cap.	<u>N/A</u>

Total Volume	<u>*Unconstrained</u>
Array Area	<u>N/A</u>
Radiator Area	<u>N/A</u>
Assembly Location	
Initial	<u>Earth</u>
Final	<u>LEO</u>

Delivery Vehicle

<input type="checkbox"/>	Shuttle
<input type="checkbox"/>	SDV
<input checked="" type="checkbox"/>	HLLV
<input type="checkbox"/>	COTV
<input type="checkbox"/>	LTV

PERFORMANCE CHARACTER:

Thrust Level	<u>800 kN/400 kN</u>
Specific Impulse	<u>4630/4630 N-s/kg</u>
Acceleration	<u>< 1g</u>
Payload Cap.	<u>*65TUp/41T Dwn</u>
Transfer Time	<u>~6 hr LEO → GEO</u>

Power Req'd	<u>N/A</u>
Efficiency	<u>N/A</u>
Consumables	<u>LO₂/LH₂</u>
Waste Heat	<u>N/A</u>
Flow Rates	<u>N/A</u>
Useful output	<u>N/A</u>

Personnel Req'ts.

<input type="checkbox"/>	Primary
<input type="checkbox"/>	Support
<input type="checkbox"/>	Supervisory
<input type="checkbox"/>	Ground
<u>0</u>	Total

Data Source(s) 1-25-78 JSC SPS Concept Evaluation Program/Preliminary Baseline Concept

Prepared by C. W. Shawl

Reviewed by _____

COTV are shown in Figure 4-39. Since there are two different types of SPS segments, there are also two different COTV configurations. The six non-antenna segments would utilize four panels of 600 thrusters each with 3,000 T of propellant while the two antenna segments would utilize four panels of 1600 thrusters each and 8,400 T of propellant. The COTV hardware is not reused.

e. Passenger Module and POTV Crew Control Module (PM)

The passenger module is designed to support 75 personnel within the Space Shuttle Orbiter cargo bay for transport into LEO and return to earth. The passenger module is configured so that it may be removed from the payload bay in LEO and integrated with the POTV and POTV crew control module. In this configuration, the passenger module can be transported to GEO. General descriptions of the passenger module and crew control module are given in Figure 4-40. This passenger logistics equipment is employed for all three LRU system concepts in addition to the Concept A SPS Earth Baseline.

Earth launch vehicles considered for cargo transfer in lunar resource utilization concepts are the Space Shuttle (SS), a shuttle derived vehicle (SDV) with reusable glideback booster, and the new development fully reusable heavy lift launch vehicle (HLLV) described in Paragraph a and Figure 4-36. Comparison of earth cargo vehicle launch frequency requirements for the SPS earth baseline and LRU Concept C to support construction of one SPS per year is shown in Figure 4-41. Also shown are total earth launch vehicle related program costs for constructing 30 SPS, assuming cargo requirements as defined by LRU Concept C. This data indicates that either the SDV or HLLV would be suitable to support this activity level, but that shuttle is too payload limited for cost effectiveness. Therefore, we have specified that all three Lunar Resource Utilization concepts (B, C and D) conceptually use a shuttle derived vehicle for earth launch of materials and propellants. The SDV is based on the current Space Shuttle Transportation System (SSTS) with modifications as described in Paragraph f.

Figure 4-39.
LRU ELEMENT DATA SHEET
GENERAL DESCRIPTION

<input type="checkbox"/>	Material Processing	Element Definition	<u>Cargo Orbit Transfer Vehicle</u>
<input checked="" type="checkbox"/>	Transportation		<u>(COTV)</u>
<input type="checkbox"/>	Infrastructure	Sizing Assumptions	<u>SPS delivered to GEO in 8 modules, 6 without MPTS antennas, 2 with</u>

<p>Sketch (Include Major Dimensions)</p>	<p>Scaling Relationships</p> <p>Non-linear due to occultation and solar cell degradation effects on trip time for revised payload masses. Two COTV sizes are shown in data below.</p> <p>600 Thrusters/Module W/O Antenna (1600 Thrusters/Module W/Antenna)</p>
--	---

PHYSICAL CHARACTERISTICS:

Inert Weight	<u>1,100T (2,900T)</u>	Total Volume	<u>N/A</u>	Delivery Vehicle	
Consumable Wt.	<u>3,000T (8,400T)</u>	Array Area	<u>3.65 km² (9.84 km²)</u>		<input type="checkbox"/> Shuttle
Gross Weight	<u>12,800T (35,000T)</u>	Radiator Area	<u>N/A</u>		<input type="checkbox"/> SDV
Throughput	<u>N/A</u>	Assembly Location	<u>Earth</u>		<input checked="" type="checkbox"/> HLLV
Storage Cap.	<u>N/A</u>	Initial	<u>Orbit</u>	<input type="checkbox"/> COTV	
		Final	<u>Orbit</u>	<input type="checkbox"/> LTV	

PERFORMANCE CHARACTER:

Thrust Level	<u>4500N (12200N)</u>	Power Req'd	<u>300 MW (810MW)</u>	Personnel Req'ts.	
Specific Impulse	<u>68642 N-s/kg</u>	Efficiency	<u>75%</u>		<input type="checkbox"/> Primary
Acceleration	<u>4x10⁻⁵g</u>	Consumables	<u>AR & LO₂/LH₂</u>		<input type="checkbox"/> Support
Payload Cap.	<u>8,700T (23,700T)</u>	Waste Heat	<u>N/A</u>		<input type="checkbox"/> Supervisory
Transfer Time	<u>~ 180 days</u>	Flow Rates	<u>N/A</u>		<input type="checkbox"/> Ground
		Useful output	<u>N/A</u>		<input type="checkbox"/> 0 Total

Data Source(s) 1-25-78 JSC SPS Concept Evaluation Program/Preliminary Baseline Concept

Prepared by C. W. Shawl Reviewed by _____

Figure 4-40.
LRU ELEMENT DATA SHEET
GENERAL DESCRIPTION

<input type="checkbox"/>	Material Processing	Element Definition	<u>Passenger Module and POTV Crew</u>
<input checked="" type="checkbox"/>	Transportation		<u>Control Module</u>
<input type="checkbox"/>	Infrastructure	Sizing Assumptions	<u>75 Passengers plus 2 person crew</u>

<p>Sketch (Include Major Dimensions)</p>	<p>Scaling Relationships</p> <p>Approximately linear except 75 person module is designed for Earth launch in Shuttle cargo bay. Other sizes will be inefficient for use with this launch vehicle.</p>
--	---

PHYSICAL CHARACTERISTICS:		Total Volume	<u>~ 200 M³</u>	Delivery Vehicle
Inert Weight	<u>14 T</u>	Array Area	<u>N/A</u>	<input checked="" type="checkbox"/> Shuttle
Consumable Wt.	<u>~3T</u>	Radiator Area	<u>N/A</u>	<input type="checkbox"/> SDV
Gross Weight	<u>27 T</u>	Assembly Location		<input type="checkbox"/> HLLV
Throughput	<u>N/A</u>	Initial	<u>Earth</u>	<input type="checkbox"/> COTV
Storage Cap.	<u>N/A</u>	Final	<u>LEO</u>	<input type="checkbox"/> LTV
PERFORMANCE CHARACTER:		Power Req'd	<u>75 kW</u>	Personnel Req'ts.
Thrust Level	<u>N/A</u>	Efficiency	<u>N/A</u>	<input checked="" type="checkbox"/> 75 Primary
Specific Impulse	<u>N/A</u>	Consumables	<u>6 Day Supply</u>	<input checked="" type="checkbox"/> 2 Support
Acceleration	<u>≤3g</u>	Waste Heat	<u>N/A</u>	<input type="checkbox"/> Supervisory
Payload Cap.	<u>~10T</u>	Flow Rates	<u>N/A</u>	<input type="checkbox"/> Ground
Transfer Time	<u>~72 Hours</u>	Useful output	<u>N/A</u>	<input checked="" type="checkbox"/> 77 Total

Data Source(s) Solar Power Satellite Concept Evaluation Activities Report,
July 76 to June 77 Vol 2 (JSC Red Book) (Ref 2)

Prepared by E. H. Bock Reviewed by _____

We have also proposed that all three Lunar Resource Utilization concepts use the current Space Shuttle Transportation System as a personnel launch vehicle. Although personnel transfer requirements are small compared to cargo requirements, use of an unmodified Shuttle as a PLV is fairly expensive. We recommend that subsequent studies consider replacing the Space Shuttle with an SDV version for personnel launch also.

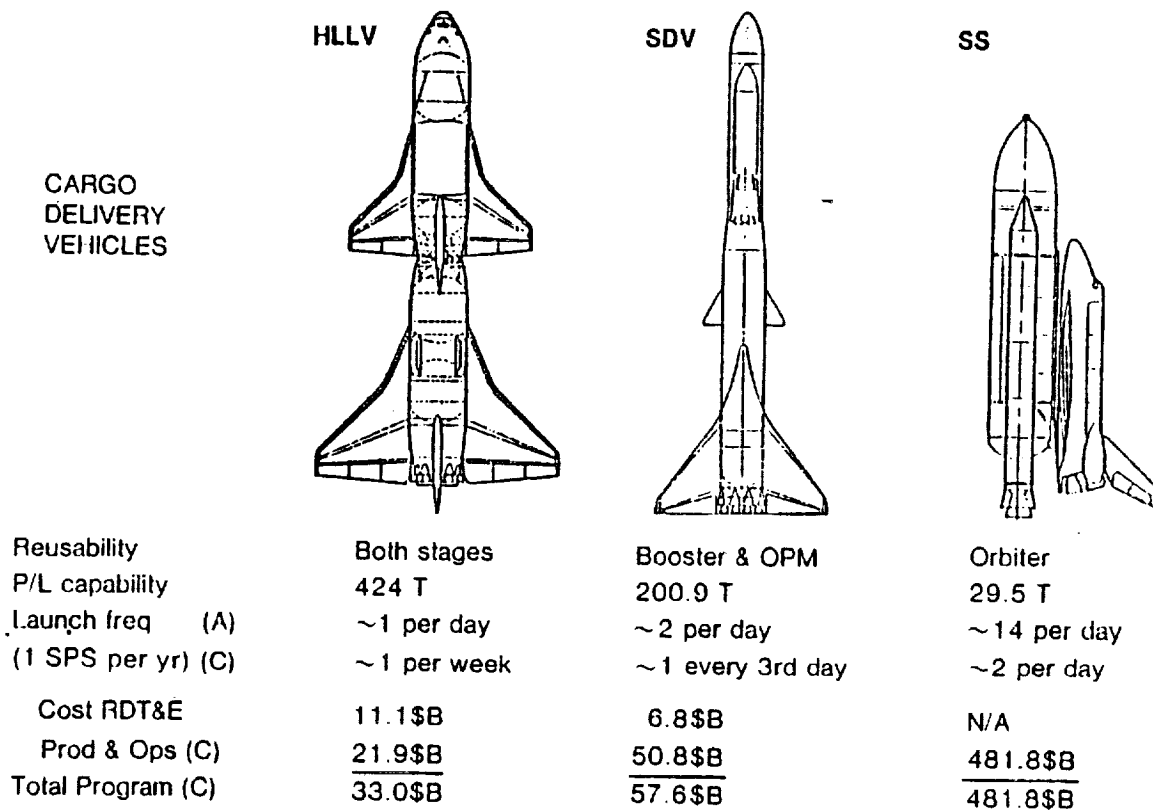

Figure 4-41. Earth launch vehicle comparative assessment.

f. Shuttle Derived Vehicle (SDV)

All three of the lunar resource utilization concepts (B, C and D) conceptually use the same Shuttle derived vehicle for earth launch of materials and propellants. The general configuration of the SDV is shown in Figure 4-42. The SDV is based on the current Space Shuttle Transportation System (SSTS) with the following modifications:

Figure 4-42.
LRU ELEMENT DATA SHEET
GENERAL DESCRIPTION

<input type="checkbox"/>	Material Processing	Element Definition	<u>Shuttle Derived Vehicle (SDV) for</u>
<input checked="" type="checkbox"/>	Transportation		<u>Cargo Delivery</u>
<input type="checkbox"/>	Infrastructure	Sizing Assumptions	<u>LO₂/Propane Version B17E-1</u>
			<u>Booster with 'Orbiter' Cargo Version</u>

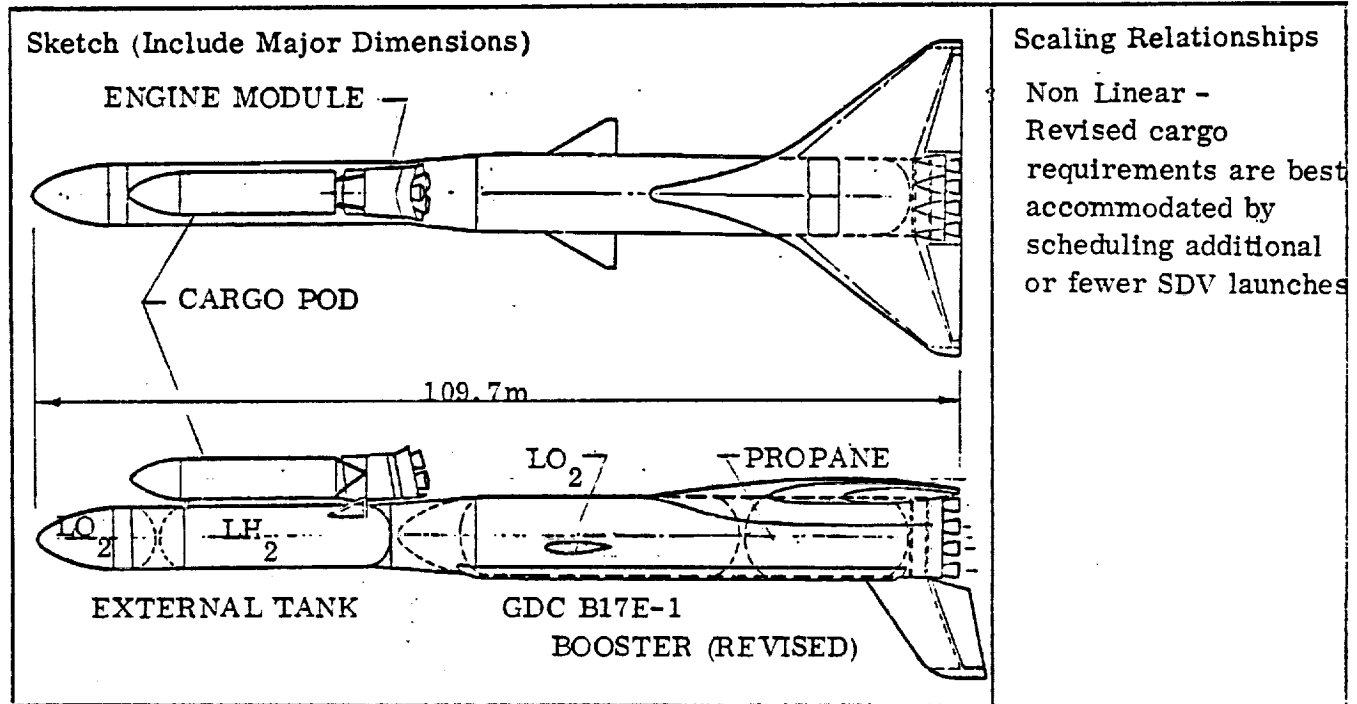

PHYSICAL CHARACTERISTICS:		Total Volume	<u>590m³</u>	Delivery Vehicle <input type="checkbox"/> Shuttle <input type="checkbox"/> SDV <input type="checkbox"/> HLLV <input type="checkbox"/> COTV <input type="checkbox"/> LTV
Inert Weight	<u>261T/91T</u>	Array Area	<u>N/A</u>	
Consumable Wt.	<u>2,932T/704T</u>	Radiator Area	<u>N/A</u>	
Gross Weight	<u>4,196T</u>	Assembly Location	<u>Earth</u>	
Throughput	<u>N/A</u>	Initial	<u>Earth</u>	
Storage Cap.	<u>N/A</u>	Final	<u>Earth</u>	

PERFORMANCE CHARACTER:		Power Req'd	<u>N/A</u>	Personnel Req'ts. <input checked="" type="checkbox"/> 6 Primary <input type="checkbox"/> Support <input type="checkbox"/> Supervisory <input type="checkbox"/> Ground <input checked="" type="checkbox"/> 6 Total
Thrust Level	<u>53x10⁶ / 6.3x10⁶ N</u>	Efficiency	<u>N/A</u>	
Specific Impulse	<u>3314/4462 N-s/kg</u>	Consumables	<u>LO₂/C₂H₈ & LO₂/LH₂</u>	
Acceleration	<u>≤3g</u>	Waste Heat	<u>N/A</u>	
Payload Cap.	<u>200.9T</u>	Flow Rates	<u>N/A</u>	
Transfer Time	<u>~1 hr</u>	Useful output	<u>N/A</u>	

Data Source(s) Preliminary Study of Performance and Feasibility of a Heavy Payload Shuttle Derived Vehicle SDV, Appendix E.2

Prepared by C. W. Shawl Reviewed by _____

- The solid rocket boosters (SRB's) are replaced by a liquid propellant ($\text{LO}_2/\text{C}_3\text{H}_8$) booster. This booster is a lox/propane version the GDC B17E-1 flyback booster from the SSTS Phase I study. The booster would not have air-breathing flyback capability but would land down range and be ground transported back to the launch area.
- The external tank would be modified to accept boost loads through the base ring rather than the current SRB side attachment points.
- The Orbiter would be replaced by a cargo pod and a ballistic returnable propulsion module.

Further definition of the SDV is contained in Appendix E of Volume III.

g. Space Shuttle (SS)

All three Lunar Resource utilization options would use the current Space Shuttle Transportation System as a personnel launch vehicle. The only modification would be the fitting of a 75 passenger 'bus' module in the SSTS cargo bay. This module would be transferred complete from the Shuttle to the POTV for personnel movements. Figure 4-40 defines the passenger module. The Space Shuttle configuration description is included for reference in Figure 4-43.

h. Personnel Orbital Transfer Vehicle (POTV)

All three lunar resource utilization options employ the same personnel orbital transfer vehicle. The general configuration of the POTV is shown in Figure 4-44. This POTV is a single stage vehicle. To minimize vehicle size, propellant depots supplied by COTV will be established at both ends of each run. The POTV is sized for the maximum ΔV transfer leg, which is $\text{LEO} \leftrightarrow \text{GEO}$, and operates off-tanked on less demanding transportation routes. This allows a common vehicle to be used for many routes including $\text{LEO} \leftrightarrow \text{LLO}$ and $\text{LEO} \leftrightarrow \text{SMF}$.

In operation, the complete 75 passenger personnel module will be transferred at LEO from the Shuttle Orbiter cargo bay to the POTV for transportation to the desired end point. See Paragraph e and Figure 4-40 for a description of the passenger module.

Figure 4-43.
LRU ELEMENT DATA SHEET
GENERAL DESCRIPTION

<input type="checkbox"/>	Material Processing	Element Definition	<u>Space Shuttle (SS) Personnel</u>
<input checked="" type="checkbox"/>	Transportation		<u>Launch Vehicle</u>
<input type="checkbox"/>	Infrastructure	Sizing Assumptions	<u>Vehicle currently being developed</u>

<p>Sketch (Include Major Dimensions)</p>	<p>Scaling Relationships</p> <p>Non Linear - Revised personnel requirements are best accommodated by scheduling additional or fewer SS launches</p>
--	---

PHYSICAL CHARACTERISTICS:		Total Volume	<u>300 m³</u>	Delivery Vehicle <input type="checkbox"/> Shuttle <input type="checkbox"/> SDV <input type="checkbox"/> HLLV <input type="checkbox"/> COTV <input type="checkbox"/> LTV
Inert Weight	<u>277T</u>	Array Area	<u>N/A</u>	
Consumable Wt.	<u>1727T</u>	Radiator Area	<u>N/A</u>	
Gross Weight	<u>2034T</u>	Assembly Location	<u>Earth</u>	
Throughput	<u>N/A</u>	Initial	<u>Earth</u>	
Storage Cap.	<u>N/A</u>	Final	<u>Earth</u>	

PERFORMANCE CHARACTER:		Power Req'd	<u>N/A</u>	Personnel Req'ts. <input type="checkbox"/> 4 Primary <input type="checkbox"/> Support <input type="checkbox"/> Supervisory <input type="checkbox"/> Ground <input checked="" type="checkbox"/> 4 Total
Thrust Level	<u>30.3x10⁶/6.3x10⁶ N</u>	Efficiency	<u>N/A</u>	
Specific Impulse	<u>2558/4462 N-s/kg</u>	Consumables	<u>Solids & LO₂/LH₂</u>	
Acceleration	<u>≤ 3g</u>	Waste Heat	<u>N/A</u>	
Payload Cap.	<u>29.5T</u>	Flow Rates	<u>N/A</u>	
Transfer Time	<u>~1 hr</u>	Useful output	<u>N/A</u>	

Data Source(s) JSC 07700 Vol XIV Space Shuttle Payload Accommodations

Prepared by C. W. Shawl Reviewed by _____

Figure 4-44.
LRU ELEMENT DATA SHEET
GENERAL DESCRIPTION

<input type="checkbox"/>	Material Processing	Element Definition	<u>Personnel Orbital Transfer Vehicle</u>
<input checked="" type="checkbox"/>	Transportation		<u>(POTV)</u>
<input type="checkbox"/>	Infrastructure	Sizing Assumptions	<u>LEO → GEO Transfer of 75 passengers.</u>

Single stage LO₂/LH₂ vehicle with propellant depots at all destinations

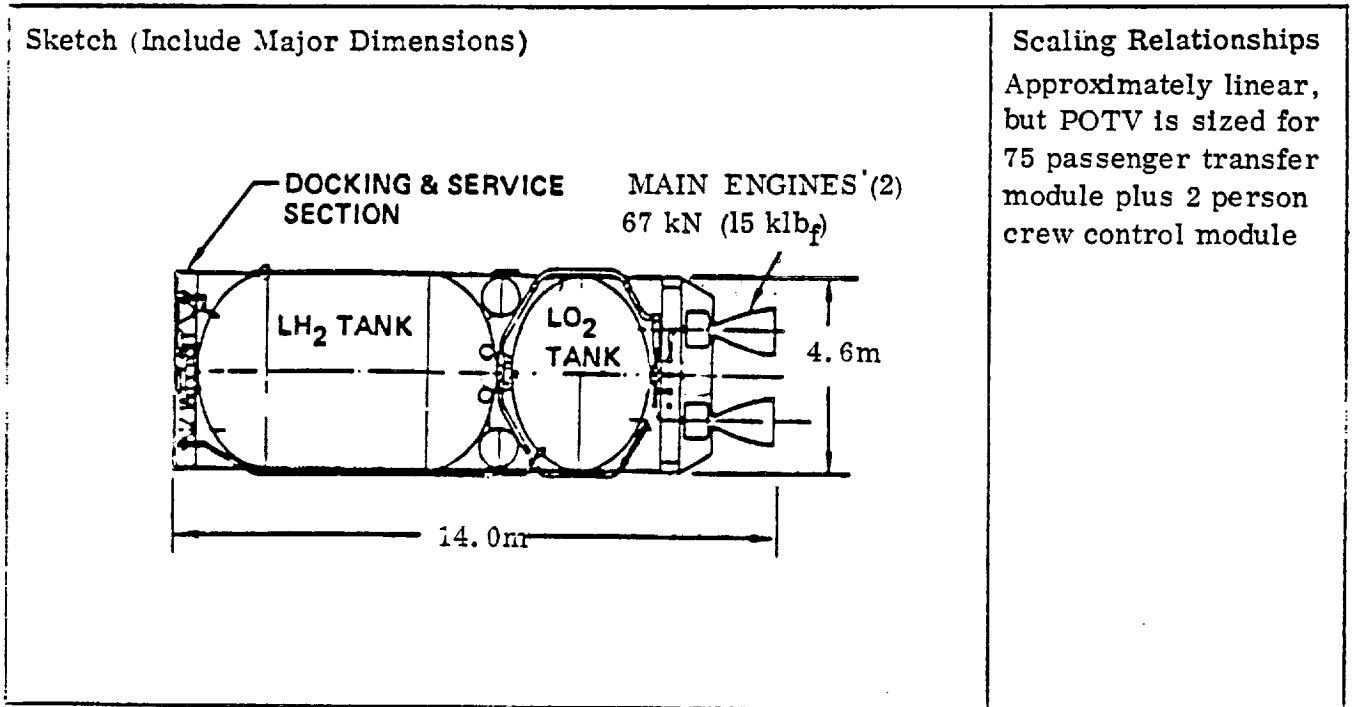

PHYSICAL CHARACTERISTICS:

Inert Weight	<u>6.7T</u>
Consumable Wt.	<u>59.4T</u>
Gross Weight	<u>88.2T</u>
Throughput	<u>N/A</u>
Storage Cap.	<u>N/A</u>

Total Volume	<u>Unconstrained</u>
Array Area	<u>N/A</u>
Radiator Area	<u>N/A</u>
Assembly Location	
Initial	<u>Earth</u>
Final	<u>Earth</u>

Delivery Vehicle

<input type="checkbox"/>	Shuttle
<input checked="" type="checkbox"/>	SDV
<input type="checkbox"/>	HLLV
<input type="checkbox"/>	COTV
<input type="checkbox"/>	LTV

PERFORMANCE CHARACTER:

Thrust Level	<u>133 kN</u>
Specific Impulse	<u>4508 N-s/kg</u>
Acceleration	<u>1g</u>
Payload Cap.	<u>27T</u>
Transfer Time	<u>~72 hrs</u>

Power Req'd	<u>N/A</u>
Efficiency	<u>N/A</u>
Consumables	<u>LO₂/LH₂</u>
Waste Heat	<u>N/A</u>
Flow Rates	<u>N/A</u>
Useful output	<u>N/A</u>

Personnel Req'ts.

<input type="checkbox"/>	Primary
<input type="checkbox"/>	Support
<input type="checkbox"/>	Supervisory
<input type="checkbox"/>	Ground
<input type="checkbox"/>	Total

Data Source(s) GDC Sizing Information and Vehicle Synthesis Programs

Prepared by C. W. Shaw

Reviewed by _____

i. Cargo Orbital Transfer Vehicle (COTV)

The three lunar resource utilization options all conceptually employ ion electric cargo orbital transfer vehicles. The general configuration of these COTVs is shown in Figure 4-45. Unlike the Concept A ion COTV, these vehicles will include their own solar cell array and will be reusable. Lunar derived oxygen will be utilized as the propellant.

The performance and sizing of these COTVs has been based on the ion thruster characteristics provided by NASA-Lewis Research Center in Reference 57. The solar array performance was conservatively assumed for sizing purposes to be 150 watts/kilogram and 100 watts/square meter. Reference 57 data is included in Appendix E. 3.

Table 4-53 presents payload, weight and array area data for the COTVs. These data are based on the thruster characteristics of Reference 57, the noted solar array performance, and the assumptions noted previously for Tables 4-49 through 4-52. The information has not been adjusted to the modular concept noted below. By definition, leg 1 is the outbound leg from the servicing facility and leg 2 is the return trip.

In order to meet the varied requirements of different transportation legs at minimum cost, it is assumed that a modular concept would be used for the COTVs with common building blocks of thruster groups, solar array panels, and propellant tanks. The thrusters described in Reference 57 are circular with a diameter of 100 cm. These could be conveniently arranged into a matrix to form a square module. For instance, a module of 100 thrusters (10 × 10) might be considered; this package would be approximately 11 meters on each side. The module would weigh approximately 6,760 kg exclusive of propellant tankage or solar array, but including all ancillary equipment.

j. Lunar Transfer Vehicle (LTV)

Lunar resource utilization Concept C requires a vehicle for the transfer of cargo and

Figure 4-45.
LRU ELEMENT DATA SHEET
GENERAL DESCRIPTION

<input type="checkbox"/>	Material Processing	Element Definition	<u>Cargo Orbital Transfer Vehicle</u>
<input checked="" type="checkbox"/>	Transportation		<u>(COTV)</u>
<input type="checkbox"/>	Infrastructure	Sizing Assumptions	<u>See Table 4-53 for vehicle sizing</u>

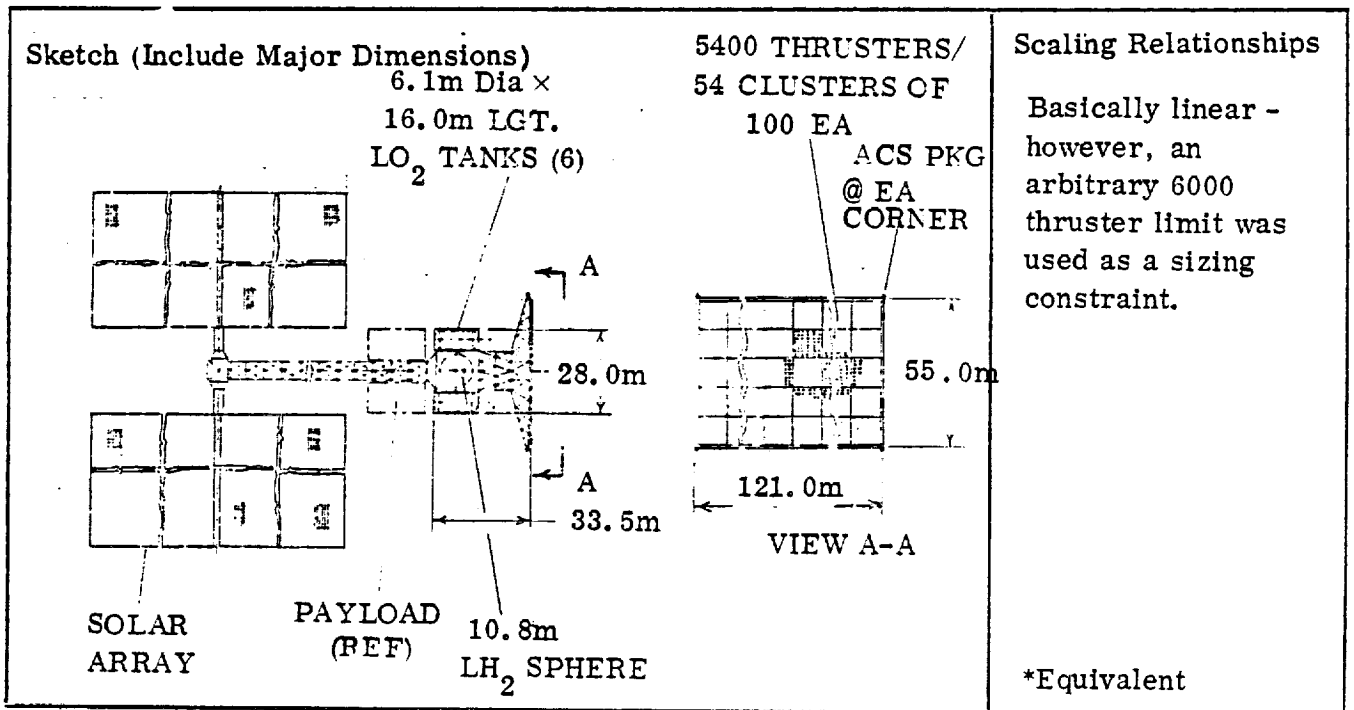

PHYSICAL CHARACTERISTICS:

Inert Weight	<u>850 kg/Thruster</u>	Total Volume	<u>Unconstrained</u>	Delivery Vehicle
Consumable Wt.	<u>See Table 4.6-6</u>	Array Area	<u>1172 m²/Thruster</u>	
Gross Weight	<u>Inert + Prop + P/L</u>	Radiator Area	<u>N/A</u>	<input checked="" type="checkbox"/> SDV
Throughput	<u>N/A</u>	Assembly Location	<u>Earth</u>	<input type="checkbox"/> HLLV
Storage Cap.	<u>N/A</u>	Initial	<u>LEO</u>	<input type="checkbox"/> COTV
		Final	<u>LEO</u>	<input type="checkbox"/> LTV

PERFORMANCE CHARACTER:

Thrust Level	<u>2.03 N/Thruster</u>	Power Req'd	<u>117 kW/Thruster</u>	Personnel Req'ts.
Specific Impulse	<u>64425 N-s/kg*</u>	Efficiency	<u>63%</u>	
Acceleration	<u>See Table 4.6-6</u>	Consumables	<u>LO₂ Main LO₂/LH₂ACS</u>	<input type="checkbox"/> Support
Payload Cap.	<u>See Table 4.6-6</u>	Waste Heat	<u>N/A</u>	<input type="checkbox"/> Supervisory
Transfer Time	<u><180 days/leg</u>	Flow Rates	<u>N/A</u>	<input type="checkbox"/> Ground
		Useful output	<u>N/A</u>	<input type="checkbox"/> Total

Data Source(s) Electric Propulsion System for LRU for Space Construction, Memo to E. H. Bock from NASA LeRC Dated 27 June 1978. See Appendix E.

Prepared by C. W. Shawl

Reviewed by _____

Table 4-53. Ion Electric COTV Characteristics.

LRU Concept	Vehicle	Thruster Quantity	Initial Thrust/Weight	Leg	Payload (T)	Inert Weight (T)	Total Propellant (T)	Array Area (m ²)
B	COTV ₂	240	1×10^{-4}	1(LEO → LLO) 2(LLO → LEO)	118 0	204T	173T	0.28×10^6
	COTV ₃	2740	5×10^{-5}	1(SMF → LEO) 2(LEO → SMF)	3295.5T 6576.5T	2329T	4625T	3.2×10^6
	COTV ₄	5880	3×10^{-5}	1(SMF → GEO) 2(GEO → SMF)	32865.3T 0	4998T	2687T	6.9×10^6
C	COTV ₁	1120	3×10^{-5}	1(LEO → GEO) 2(GEO → LEO)	5293T 0	952T	1468T	1.3×10^6
	COTV ₂	5512	1×10^{-4}	1(LLO → LEO) 2(LEO → LLO)	1987T 2540T	4685T	4735T	6.5×10^6
	COTV ₃	5400	3×10^{-5}	1(LLO → GEO) 2(GEO → LLO)	29678T 0	4590T	2965T	6.3×10^6
D	COTV ₁	1120	3×10^{-5}	1(LEO → GEO) 2(GEO → LEO)	5293T 0	952T	1468T	1.3×10^6
	COTV ₂	5500	1×10^{-4}	1(LLO → LEO) 2(LEO → LLO)	2328T 1381T	4675T	4378T	6.4×10^6
	COTV ₃	5400	3×10^{-5}	1(LLO → GEO) 2(GEO → LLO)	29678T 0	4590T	2965T	6.3×10^6

personnel between the lunar surface and low lunar orbit. The general configuration of this LTV is shown in Figure 4-46. The vehicle is a single stage fully reusable chemical rocket using LO_2/LH_2 propellants. In operation, round trip hydrogen will be loaded at the low lunar orbit (LLO) propellant depot while round trip oxygen would be loaded on the lunar surface. Due to this staggered propellant loading operation, the vehicle gross weight does not correspond to a propellant tanks fully loaded condition.

As shown in Figure 4-46, the configuration chosen for the LTV is tandem liquid oxygen and liquid hydrogen tanks with the cargo carried on two side mounted pods. The side mount was chosen to minimize handling equipment requirements on the lunar surface. For the approximately twenty flights required for crew-rotation each six month period, the 75 passenger module will either be carried on a third set of side attach points, or in tandem atop the hydrogen tank.

k. Lunar Derived Rocket (LDR)

Lunar resource utilization Concept D employs a lunar derived rocket for transfer of cargo from the lunar surface to low lunar orbit. The general characteristics of this LDR are shown in Figure 4-47. This is a single stage vehicle utilizing lunar derived aluminum and oxygen as propellants. This concept is described in detail in Appendix E Section E.4, Volume III.

The general configuration chosen for the LDR consists of a central liquid oxygen tank flanked by two powdered aluminum canisters. Cargo would be carried on two side mounted pods located between the aluminum canisters. Side mounted aluminum canisters and cargo pods were chosen to minimize material handling equipment requirements on the lunar surface. For the approximately twenty flights required for each six month crew rotation period, the 75 passenger module will be tandem mounted atop the oxygen tank. While this will require lunar surface support equipment to reach the top of the vehicle, the loads to be transferred are not high.

Figure 4-46.
LRU ELEMENT DATA SHEET
GENERAL DESCRIPTION

<input type="checkbox"/>	Material Processing	Element Definition	<u>Lunar Transfer Vehicle (LTV)</u>
<input checked="" type="checkbox"/>	Transportation		
<input type="checkbox"/>	Infrastructure	Sizing Assumptions	<u>1 launch per Earth day with 310T payload</u>

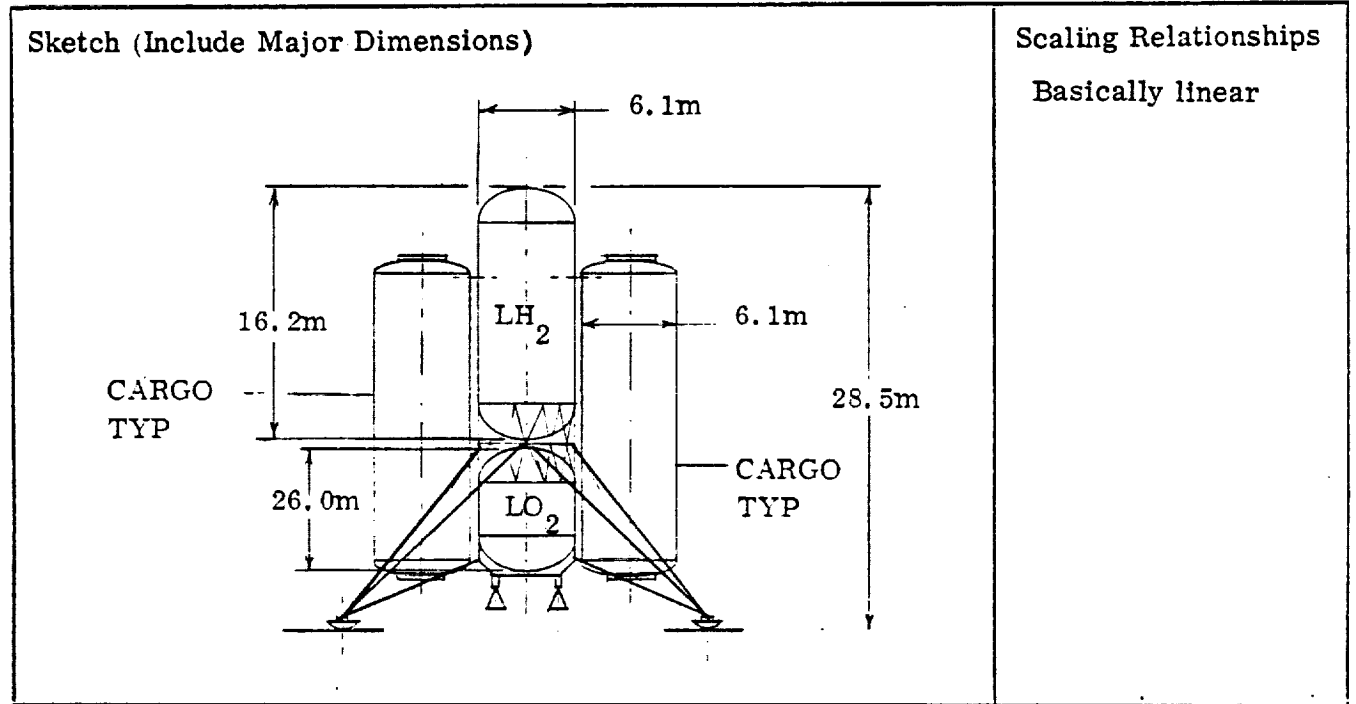

PHYSICAL CHARACTERISTICS:		Total Volume	<u>Unconstrained</u>	Delivery Vehicle
Inert Weight	<u>30T</u>	Array Area	<u>N/A</u>	<input type="checkbox"/> Shuttle
Consumable Wt.	<u>242.3T (RT)</u>	Radiator Area	<u>N/A</u>	<input checked="" type="checkbox"/> SDV
Gross Weight	<u>576.9T (Up)</u>	Assembly Location		<input type="checkbox"/> HLLV
Throughput	<u>N/A</u>	Initial	<u>Earth</u>	<input checked="" type="checkbox"/> COTV
Storage Cap.	<u>N/A</u>	Final	<u>LEO</u>	<input type="checkbox"/> LTV

PERFORMANCE CHARACTER:		Power Req'd	<u>N/A</u>	Personnel Req'ts.
Thrust Level	<u>2,930 kN</u>	Efficiency	<u>N/A</u>	<input type="checkbox"/> Primary
Specific Impulse	<u>4508 N-s/kg</u>	Consumables	<u>LO₂/LH₂</u>	<input type="checkbox"/> Support
Acceleration	<u>0.35 g LO</u>	Waste Heat	<u>N/A</u>	<input type="checkbox"/> Supervisory
Payload Cap.	<u>310T (Up)</u>	Flow Rates	<u>N/A</u>	<input type="checkbox"/> Ground
Transfer Time	<u>~1 hr</u>	Useful output	<u>N/A</u>	<input type="checkbox"/> 0 Total

Data Source(s) GDC Sizing Information and Vehicle Synthesis Programs

Prepared by C. W. Shawl Reviewed by _____

Figure 4-47.
LRU ELEMENT DATA SHEET
GENERAL DESCRIPTION

<input type="checkbox"/>	Material Processing	Element Definition	<u>Lunar Derived Rocket (LDR)</u>
<input checked="" type="checkbox"/>	Transportation		
<input type="checkbox"/>	Infrastructure	Sizing Assumptions	<u>1 Launch per Earth day with 300T Payload</u>

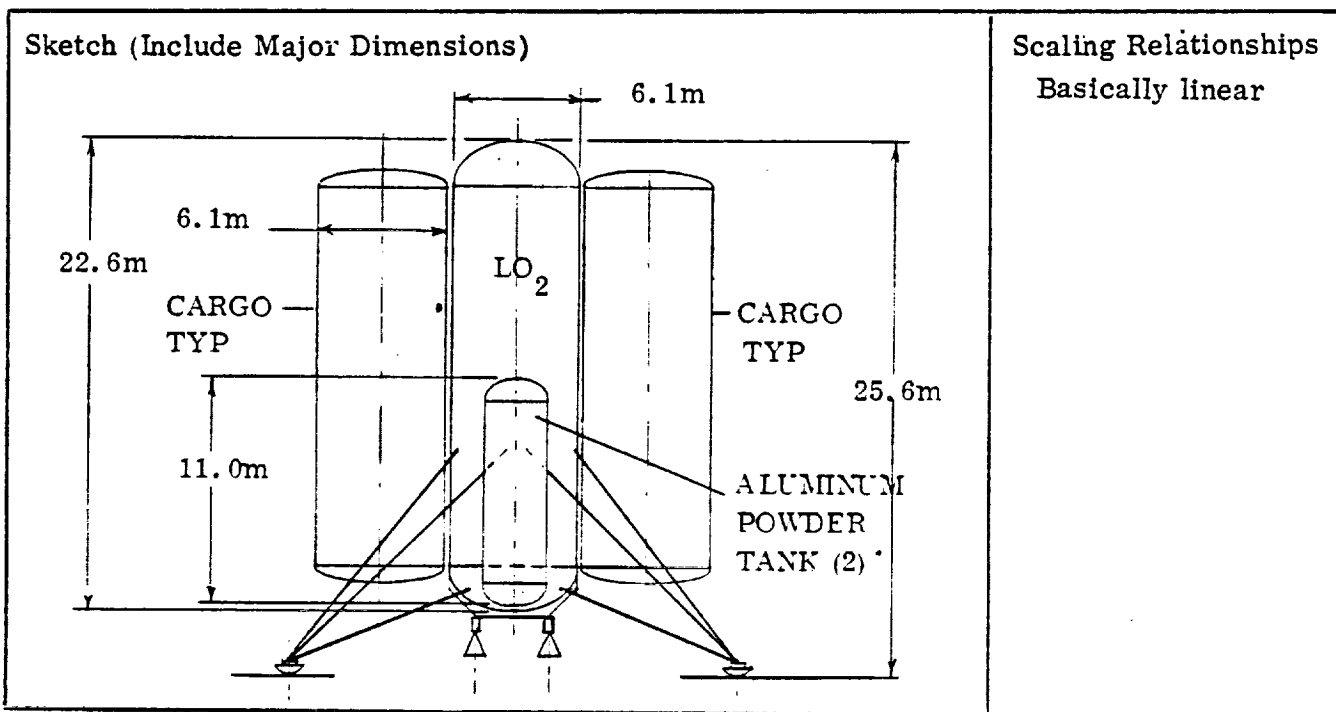

PHYSICAL CHARACTERISTICS:

Inert Weight	<u>180T</u>
Consumable Wt.	<u>1,017T (RT)</u>
Gross Weight	<u>1,497T (Up)</u>
Throughput	<u>N/A</u>
Storage Cap.	<u>N/A</u>

Total Volume	<u>Unconstrained</u>
Array Area	<u>N/A</u>
Radiator Area	<u>N/A</u>
Assembly Location	
Initial	<u>Earth</u>
Final	<u>LEO</u>

Delivery Vehicle

<input type="checkbox"/>	Shuttle
<input checked="" type="checkbox"/>	SDV
<input type="checkbox"/>	HLLV
<input checked="" type="checkbox"/>	COTV
<input type="checkbox"/>	LTV

PERFORMANCE CHARACTER:

Thrust Level	<u>7590 kN</u>
Specific Impulse	<u>2500 N-s/kg</u>
Acceleration	<u>0.35 g LO</u>
Payload Cap.	<u>300T (Up)</u>
Transfer Time	<u>~1 hr</u>

Power Req'd	<u>N/A</u>
Efficiency	<u>N/A</u>
Consumables	<u>LO₂/Al powder</u>
Waste Heat	<u>N/A</u>
Flow Rates	<u>N/A</u>
Useful output	<u>N/A</u>

Personnel Req'ts.

<input type="checkbox"/>	Primary
<input type="checkbox"/>	Support
<input type="checkbox"/>	Supervisory
<input type="checkbox"/>	Ground
<input type="checkbox"/>	0 Total

Data Source(s) Preliminary Investigation of the Feasibility of Chemical Rockets Using Lunar Derived Propellants, J. W. Streetman, GDC. See Appendix E.4.

Prepared by C. W. Shawl Reviewed by _____

l. Mass Driver Catapult

Lunar resource utilization Concept B utilizes a mass driver catapult to 'launch' lunar material from the moon's surface. The mass driver is an electro-magnetic linear accelerator. The general characteristics of the mass driver are described in Figure 4-48, these are based on information in References 58 and 59 sized for the current Concept B as described in Figure 4-3 on page 4-17. The mass driver may be powered either by a nuclear generating plant or a photovoltaic array. In the first case, scheduled operation would be continuous except for periods when the mass catcher is off station initiating cargo transfer and retrieving stores. In the latter case, scheduled operation is limited to approximately 320 hours out of each 28 (earth) day lunar cycle.

In operation, lunar soil is loaded in fiberglass bags (derived from lunar material) which are in turn loaded into the mass driver buckets. The buckets and payload are accelerated to 'launch' velocity of 2335 m/sec with the bucket then decelerated and returned on a parallel track. The payload continues its flight through electrostatic deflector correctors for trajectory fine-adjustment. The mass driver operates at a rate of 5 bags per second. The payload stream from the mass driver is retrieved by the mass catcher orbiting about the moon's L_2 libration point.

m. Mass Catcher

Lunar resource utilization Concept B requires a mass catcher to capture the material 'launched' by the mass driver. The general configuration of the catcher is shown in Figure 4-49. This configuration is based on information from Reference 60. The catcher conceptually consists of a ring shaped structure which supports the mouth of a conical kevlar bag. The ring structure contains all the catcher support systems such as power, guidance, and propulsion. The catcher has been resized for the currently defined Concept B, as depicted in Table 4-50.

Figure 4-48.
LRU ELEMENT DATA SHEET
GENERAL DESCRIPTION

<input type="checkbox"/>	Material Processing	Element Definition	<u>Mass Driver Catapult</u>
<input checked="" type="checkbox"/>	Transportation		
<input type="checkbox"/>	Infrastructure	Sizing Assumptions	<u>5 Bags/Sec to an escape velocity of</u> <u>2,335 m/s - power supply facility not included in mass estimate</u>

<p>Sketch (Include Major Dimensions)</p>	<p>Scaling Relationships</p> <p>Some launch mass variation can be accommodated with little or no facility impact, by changing the launch frequency and/or payload per bag. A large mass increase would require substantial redesign or installation of a second mass driver</p>
--	---

PHYSICAL CHARACTERISTICS:

Inert Weight	<u>1050T</u>	Total Volume	<u>N/A</u>	Delivery Vehicle <input type="checkbox"/> Shuttle <input checked="" type="checkbox"/> SDV <input type="checkbox"/> HLLV <input checked="" type="checkbox"/> COTV <input type="checkbox"/> LTV
Consumable Wt.	<u>N/A</u>	Array Area	<u>.33 × 10⁶ m²</u>	
Gross Weight	<u>1050T</u>	Radiator Area	<u>N/A</u>	
Throughput	<u>168,000 T/vr</u>	Assembly Location		
Storage Cap.	<u>N/A</u>	Initial	<u>Earth</u>	
		Final	<u>Lunar Surface</u>	

PERFORMANCE CHARACTER:

Thrust Level	<u>17,500N</u>	Power Req'd	<u>35 MW</u>	Personnel Req'ts. <input type="checkbox"/> Primary <input type="checkbox"/> Support <input type="checkbox"/> Supervisory <input type="checkbox"/> Ground <input type="checkbox"/> Total
Specific Impulse	<u>N/A</u>	Efficiency	<u>N/A</u>	
Acceleration	<u>100 g</u>	Consumables	<u>Electric Power</u>	
Payload Cap.	<u>2.5 kg/bag</u>	Waste Heat	<u>N/A</u>	
Transfer Time	<u>N/A</u>	Flow Rates	<u>N/A</u>	
		Useful output	<u>N/A</u>	

Data Source(s) Mass Driver Applications, Chilton, Hibbs, Kolm, O'Neill & Phillips.

Prepared by C. W. Shawl Reviewed by _____

Figure 4-49.
LRU ELEMENT DATA SHEET
GENERAL DESCRIPTION

<input type="checkbox"/>	Material Processing	Element Definition	Mass Catcher
<input checked="" type="checkbox"/>	Transportation		
<input type="checkbox"/>	Infrastructure	Sizing Assumptions	Two loads per year

<p>Sketch (Include Major Dimensions)</p>	<p>Scaling Relationships</p> <p>Non-Linear - Higher Cargo Rates would be handled by increased load frequency</p>
--	--

PHYSICAL CHARACTERISTICS:		Total Volume	334,000 m ³	Delivery Vehicle <input type="checkbox"/> Shuttle <input checked="" type="checkbox"/> SDV <input type="checkbox"/> HLLV <input checked="" type="checkbox"/> COTV <input type="checkbox"/> LTV
Inert Weight	1227T	Array Area	N/A	
Consumable Wt.	4006T	Radiator Area	N/A	
Gross Weight	86227T	Assembly Location	Earth	
Throughput	N/A	Initial	Lunar Orbit	
Storage Cap.	N/A	Final	Lunar Orbit	

PERFORMANCE CHARACTER:		Power Req'd	_____	Personnel Req'ts. <input type="checkbox"/> Primary <input type="checkbox"/> Support <input type="checkbox"/> Supervisory <input type="checkbox"/> Ground <input type="checkbox"/> 0 Total
Thrust Level	38.4 kN	Efficiency	_____	
Specific Impulse	3969 N-s/kg	Consumables	Slag Pellets	
Acceleration	10 ⁻⁴ g	Waste Heat	N/A	
Payload Cap.	85,000T	Flow Rates	N/A	
Transfer Time	N/A	Useful output	N/A	

Data Source(s) Heppenheimer, T. A., The Lunar Mass Transport Problem in Space
Colonization ADS/AIAA Conf. Jackson Hole, WY, Sept 7-9, 1977

Prepared by C. W. Shawl Reviewed by _____

The mass catcher is one of the less well defined transportation elements with no historical background on which to draw. Several modifications to the configuration presented in Reference 60 may be desirable and will require additional trade studies. Some of these are:

1. Replacement of the rotary pellet launcher propulsion system with a liquid oxygen/liquid hydrogen system or an electric ion system, or a combination of both. If an electric system is chosen, the power source would probably remain nuclear as there is considerable potential for damage to a solar array by the mass stream if either stream or vehicle slips out of position.
2. Reference 60 holds the catcher rim stationary while spinning the bag. It may be possible to spin the entire vehicle.
3. Conversely, it may be possible to contain captured lunar material by means other than centrifugal force, thereby eliminating the need for spinning.
4. The catcher may be provided with sufficient ΔV to make the transfer to the space manufacturing facility (SMF) and return, thereby eliminating the need for the terminal tug, i. e., catcher and terminal tug functions are combined into one vehicle.
5. If the mass driver on the lunar surface is solar powered, the catcher may be downsized to hold one lunar day's worth of material with transfer to the SMF taking place during the lunar night. This may be impractical since a minimum energy $L_2 \rightarrow$ SMF transfer takes ~ 2.5 lunar days (Reference 61).

n. Terminal Tug

Lunar resource utilization Concept B requires a terminal tug operating in the vicinity of the space manufacturing facility (SMF). The general configuration of this tug is shown in Figure 4-50. The tug retrieves the bag of lunar material launched by the mass catcher toward the SMF, and launches propellants and empty bags back to the catcher. Reference 60 defined the need for the tug and presented it as utilizing a solar powered rotary pellet launcher propulsion system (RPL). The participants in the LRU study do

Figure 4-50.
LRU ELEMENT DATA SHEET
GENERAL DESCRIPTION

<input type="checkbox"/>	Material Processing	Element Definition	<u>Terminal Tug (TT)</u>
<input checked="" type="checkbox"/>	Transportation		
<input type="checkbox"/>	Infrastructure	Sizing Assumptions	<u>Handles One Catcher Load</u>

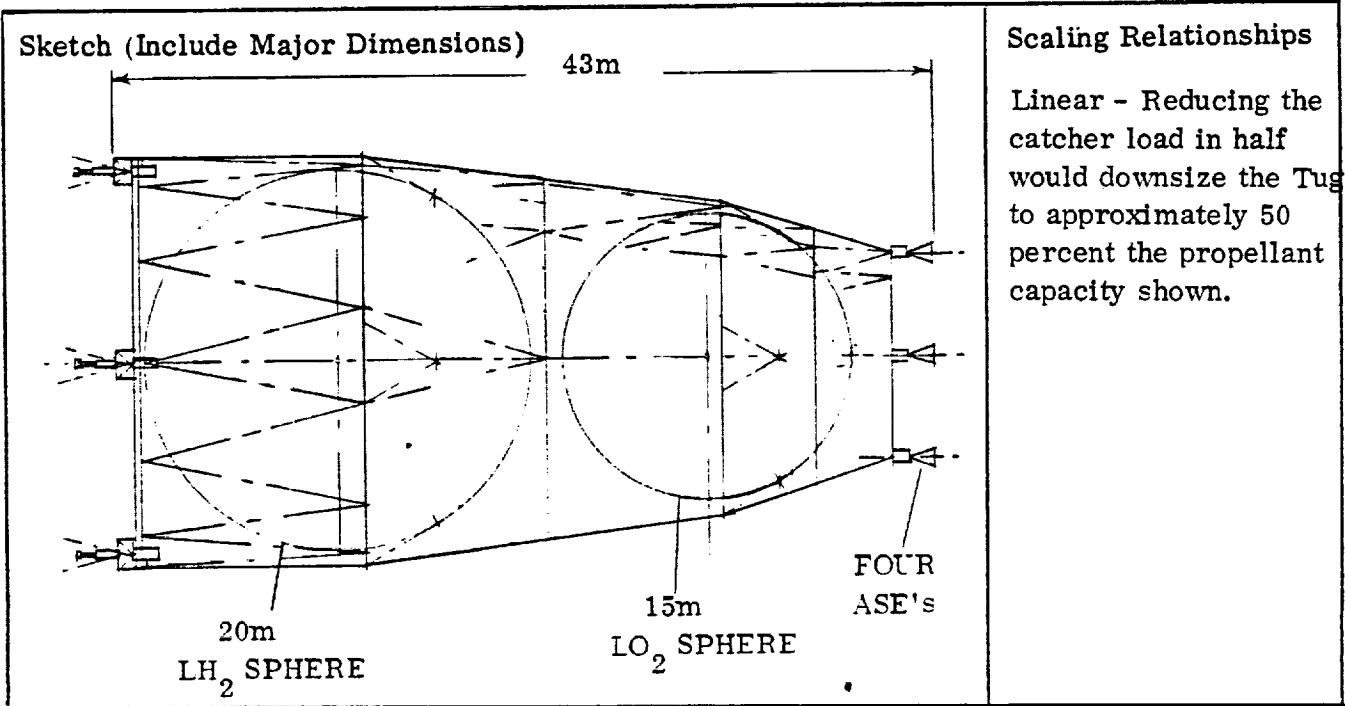

PHYSICAL CHARACTERISTICS:

Inert Weight 236T
 Consumable Wt. 1.910T
 Gross Weight 87.146T
 Throughput N/A
 Storage Cap. N/A

Total Volume Unconstrained
 Array Area N/A
 Radiator Area N/A
 Assembly Location
 Initial Earth
 Final SMF

Delivery Vehicle

Shuttle
 SDV
 HLLV
 COTV
 LTV

PERFORMANCE CHARACTER:

Thrust Level _____
 Specific Impulse 4508 N-s/kg
 Acceleration _____
 Payload Cap. 85,000T
 Transfer Time _____

Power Req'd N/A
 Efficiency N/A
 Consumables LO₂/LH₂
 Waste Heat N/A
 Flow Rates N/A
 Useful output N/A

Personnel Req'ts.

Primary
 Support
 Supervisory
 Ground
 Total

Data Source(s) Ref 60, plus GDC Sizing Information and Vehicle Synthesis Programs

Prepared by C. W. Shawl

Reviewed by _____

not consider the RPL to be a viable system for use in the vicinity of the SMF. Therefore, the tug has been conceptually defined as a large liquid hydrogen/liquid oxygen vehicle. An electric ion vehicle is, of course, an alternative possibility. As noted in the previous catcher section, another alternative is to eliminate this vehicle by providing the mass catcher with sufficient ΔV to conduct the complete transfer on its own.

Catcher/Terminal Tug Options

LRU Concept B mass catcher was based on Dr. Heppenheimer's Lunar Mass Transport Paper presented at Jackson Hole during September 1977. The mass catcher collects the material launched from the lunar surface by the mass driver. This incoming stream of material will reach the catcher with an average relative velocity of 230 m/sec. The catcher maneuvers in the vicinity of L_2 to maintain targetability along the incoming material's trajectory. In addition, the catcher maneuvers continuously to optimize velocity and position during a catching cycle. At the end of a catching cycle, the catcher maneuvers to place its complete load of lunar material on a trajectory which intersects the SMF orbit. After completing this maneuver, the catcher must return to the proper position and velocity to start a new catching cycle. Thus the catcher maneuvers continuously in the vicinity of L_2 during the two catching cycles each year. This maneuvering is accomplished using an electric motor-driven rotary pellet launcher (RPL) which ejects reaction mass manufactured of processing slag. A terminal tug travels between the SMF orbit and the mass catcher transfer orbit, rendezvousing with bags of lunar material and taking them to the SMF. It also launches stores (including slag pellets for the RPL) to the mass catcher on a return trajectory. A LO_2/LH_2 terminal tug was assumed for operation in the SMF vicinity as described in Figure 4-50.

Assessment of various mass catcher and terminal tug alternatives is summarized in Table 4-54. Providing increased mass catcher ΔV capability allows its direct transfer to the SMF and permits deletion of the tug. This eliminates problems associated with

retrieval of uncontrolled massive payloads; it also reduces or eliminates the need for manned maintenance at the catcher site. The one obvious drawback is a longer time off station for the catcher, or the requirement for several catchers.

An attractive alternative to the large self propelled catcher is a smaller self propelled catcher. An attractive propulsion system for either self propelled catcher is O₂ ion electric for station keeping, momentum absorption and basic transfer, powered by a nuclear source to preclude damage by near misses. A relatively high thrust LO₂/LH₂ ACS is needed for initial material stream acquisition and rendezvous maneuvering at the SMF. Additional evaluation of these alternative propulsion techniques should be accomplished by subsequent studies.

Table 4-54. Catcher/Terminal Tug Options.

85 kT Mall Catcher 85 kT Payload TT	85 kT Mall Catcher No Separate Tug	13 kT Mall Catcher No Separate Tug
<p>Two loads/year/SPS Catcher launches mall container toward SMF as tug launches empty container & expendables toward L₂. Retrieval reqd at both locations. One catcher & one tug <u>Vehicle Propellant</u> (annual) Catcher: 8,012 T slag plus ? ACS Tug: 3,342 T LO₂ 478 T LH₂ <u>Catcher Power Supply</u> Solar — vulnerable to damage from incoming mall Nuclear — shieldable</p>	<p>Two loads/year/SPS Catcher transports mall to SMF and returns to L₂ with empty container & expendables. No retrieval at either location. Requires two catchers <u>Propulsion Options</u> RPL: 14,040 T slag plus ? ACS Chem: 11,170 T LO₂ 1,600 T LH₂ Ion: 1,595 T LO₂ 125 T LH₂</p>	<p>13 loads/year/SPS Same. Transfer may be coordinated with lunar night for use of solar-powered mass driver catapult. Two or more catchers <u>Propulsion Options</u> Chem: 12,142 T LO₂ 1,730 T LH₂ Ion: 1,677 T LO₂ 130 T LH₂ Ion power supply Solar vs nuclear</p>

o. Personnel Lunar Transfer Vehicle (PLTV)

Since lunar resource utilization Concept B does not require a large transport vehicle for transfer between low lunar orbit and the lunar surface, a personnel lunar transfer vehicle (PLTV) is necessary. The general configuration of the PLTV is shown in Figure 4-51. The configuration selected utilizes the 75 passenger module even though the crew rotation requirements are approximately one half of this capacity. Since no lunar material processing is contemplated for Concept B except for fiberglass bags to contain mass driver payloads, both propellants for the PLTV round trip would be loaded in LLO.

4.6.3 Vehicle Comparison and Other Considerations

Cargo Orbital Transfer Vehicles (COTV) —

Cargo transfer through space can be efficiently performed with a low thrust vehicle powered by solar energy. Ion electric propulsion systems using mercury or argon propellant have been developed which can accomplish high energy transfers. Transfer durations are substantial (months or years), due to the vehicle's low thrust to weight ratio and periods of solar array shadowing near earth when solar power is unavailable.

Early work on space manufacturing with nonterrestrial resources recognized the need for such a vehicle with a propellant which could be derived from nonterrestrial materials. The mass driver reaction engine (MDRE) was proposed to fulfill this requirement. The MDRE is an electrically driven catapult, utilizing buckets magnetically aligned in a guide track and accelerated by a linear electric motor. Propellant (any convenient material) is placed in each bucket, accelerated to the selected exhaust velocity, and released. Empty buckets are decelerated and returned for subsequent use. This provides impulse to accelerate the stage plus payload, as with a conventional chemical or electric rocket. The most attractive MDRE feature is that any waste or excess material, such as slag from a processing facility, can theoretically be employed as reaction mass. The MDRE limitation is its relatively low exhaust velocity,

Figure 4-51.
LRU ELEMENT DATA SHEET
GENERAL DESCRIPTION

<input type="checkbox"/>	Material Processing	Element Definition	<u>Personnel Lunar Transfer Vehicle</u>
<input checked="" type="checkbox"/>	Transportation		<u>(PLTV)</u>
<input type="checkbox"/>	Infrastructure	Sizing Assumptions	<u>Uses standard 75 passenger personnel transfer module</u>

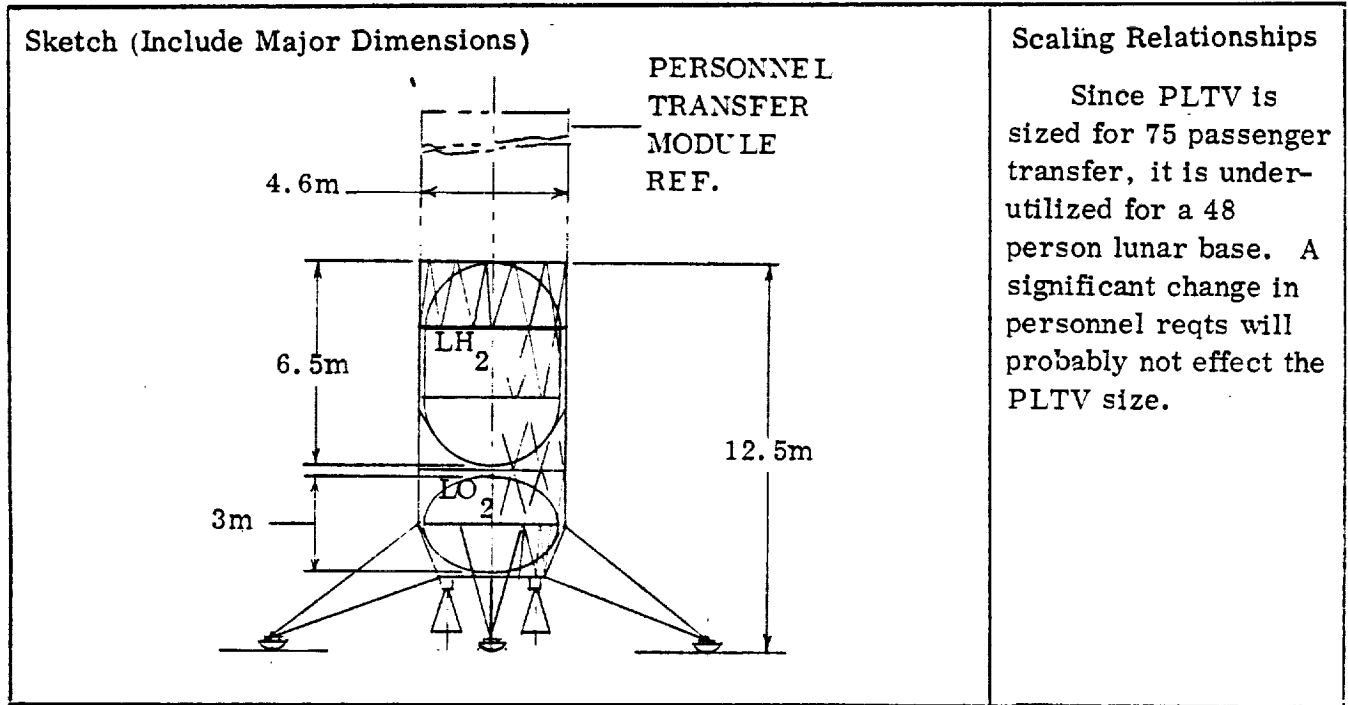

PHYSICAL CHARACTERISTICS:		Total Volume	<u>~ 200 m³</u>	Delivery Vehicle
Inert Weight	<u>5.1T</u>	Array Area	<u>N/A</u>	<input type="checkbox"/> Shuttle
Consumable Wt.	<u>41.1T</u>	Radiator Area	<u>N/A</u>	<input checked="" type="checkbox"/> SDV
Gross Weight	<u>73.9T</u>	Assembly Location		<input type="checkbox"/> HLLV
Throughput	<u>N/A</u>	Initial	<u>Earth</u>	<input checked="" type="checkbox"/> COTV
Storage Cap.	<u>N/A</u>	Final	<u>LEO</u>	<input type="checkbox"/> LTV

PERFORMANCE CHARACTER:		Power Req'd	<u>N/A</u>	Personnel Req'ts.
Thrust Level	<u>246 kN</u>	Efficiency	<u>N/A</u>	<input type="checkbox"/> Primary
Specific Impulse	<u>4508 N-sec/kg</u>	Consumables	<u>LO₂/LH₂</u>	<input type="checkbox"/> Support
Acceleration	<u>0.35 g LO</u>	Waste Heat	<u>N/A</u>	<input type="checkbox"/> Supervisory
Payload Cap.	<u>27T</u>	Flow Rates	<u>N/A</u>	<input type="checkbox"/> Ground
Transfer Time	<u>~ 1 hr</u>	Useful output	<u>N/A</u>	<input type="checkbox"/> 0 Total

Data Source(s) GDC Sizing Information and Vehicle Synthesis Programs

Prepared by C. W. Shawl Reviewed by _____

which can achieve a specific impulse approximately twice that of the best chemical rockets.

Ion electric propulsion systems accelerate charged molecular particles to very high velocities which results in specific impulse values an order of magnitude higher. Ion electric thrusters capable of using lunar derived propellants can theoretically be developed. Based on information obtained from NASA LeRC (Reference 57 and Appendix E.3), oxygen propellant ion bombardment thrusters should be feasible, but a significant development effort would be required. NASA LeRC has successfully performed ion beam etching tests in an oxygen environment with no noticeable degradation of thruster components.

Figure 4-52 shows a comparison of a mass driver reaction engine (MDRE) and an ion COTV for the delivery of 5,290T from LEO to GEO with empty return. A 180 day trip time for payload delivery has been assumed, followed by full thrust empty return with servicing accomplished in LEO. This corresponds to COTV₁ of both LRU systems Concepts C and D. The MDRE data includes no allotment for ACS, while the ion data includes a 12.5% allowance for LO₂/LH₂ attitude control propellants. The MDRE solar array is assumed to weigh 3.5 T/10⁶ watts while the ion array is sized at 4.7T/10⁶ watts; both array areas were based on generation of 150 watts/meter². These calculations have been made for an idealized LEO → GEO transfer without shadowing. To actually perform this transfer in 180 days, additional thrust and power would be required, increasing the inert mass and propellant requirements for both vehicles. For additional information, the impact of utilizing argon in the ion COTV is also shown.

Although both MDRE and ion COTV concepts appear technically feasible and utilize propellants attainable from lunar resources, the ion electric propulsion device was selected as the representative system for this study because: 1) Ion electric technology development (with argon) is more mature than MDRE technology development. 2) The ion electric specific impulse is approximately 6 times greater than

Figure 4-52. COTV Assessment.

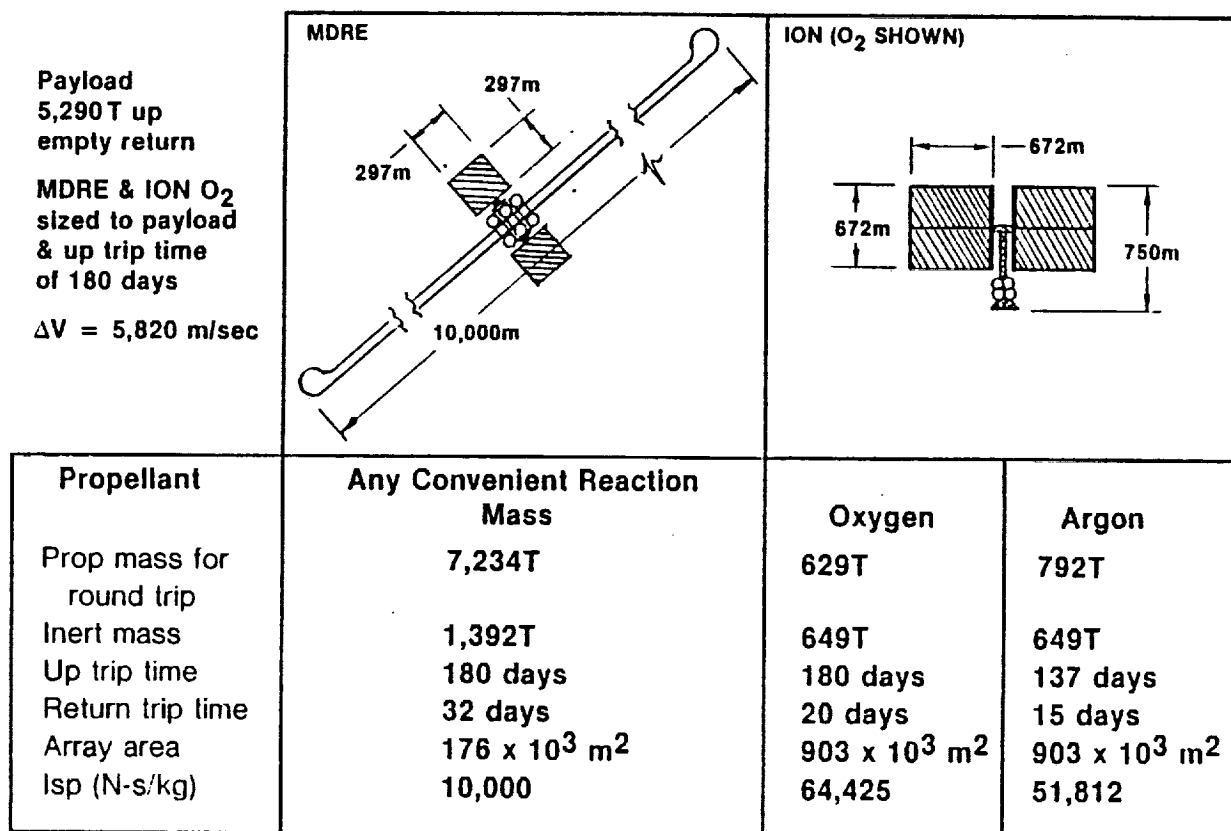

that predicted for MDRE. This combined with a projected lower inert mass for the ion electric COTV results in significantly lower propellant requirements. 3) A lunar derived propellant, oxygen, should be acceptable for use with an ion-electric COTV. This reduced somewhat the MDRE advantage of using any available waste material as reaction mass. 4) Study personnel felt strongly that if the MDRE were used, it should employ a material such as oxygen for reaction mass to eliminate the safety concern of solid high velocity exhaust particles in the vicinity of habitats, manufacturing facilities, and SPS's. Thus similar lunar propellant processing requirements are imposed for MDRE or ion electric COTV, since both use oxygen propellant.

Lunar Material Launch Technique —

The three LRU concepts are most easily distinguished by the method employed for lifting material from the lunar surface to low lunar orbit. These three launch techniques are identified and compared in Figure 4-53.

Figure 4-53. Lunar Material Launch Technique.

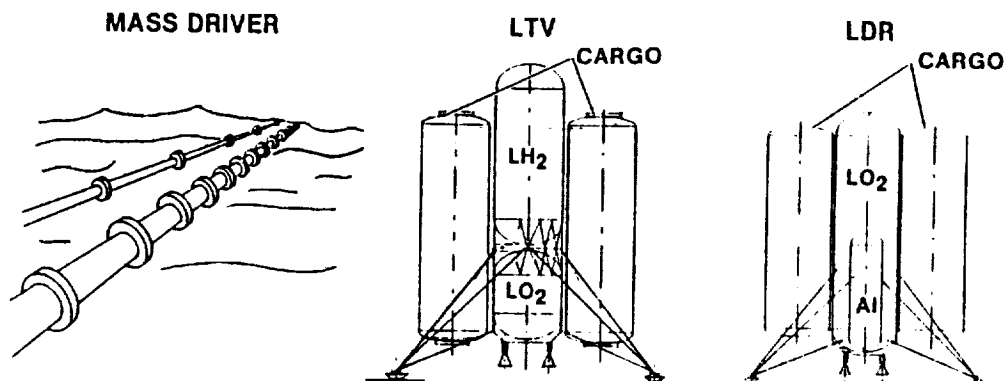

Cargo	Raw material	Dense products	Dense products
Launch rate	(5) 2.5 kg bags of material per sec	(1) 310 T payload every 24 hr	(1) 300 T payload every 24 hr
Propellant	Electrical power	LO ₂ & LH ₂	LO ₂ /Al
Prop quantity	37.5 MW	242.3 T	646.5 T
Vehicle mass	450 T	30 T	71.5 T
Fleet size	1	7	7
Pollutant release	Negligible	2.8 kg/sec	3.8 kg/sec (Volatiles only)

The mass driver, used in LRU Concept B, is an electrically driven catapult which launches small bags of lunar material at a rate of five bags per second. The catapult has significant power requirements, but since material processing is not accomplished on the moon, as it must be with Concepts C and D, the total lunar power requirements are lowest for Concept B. The mass driver catapult is more massive than LTV's and equivalent to the seven LDR's required. Since no propellants are expended, the mass driver does not release any appreciable volatiles into the lunar environment.

The lunar transfer vehicle (LTV) is employed for both cargo and personnel transfer between moon and LLO in LRU Concept C. The vehicle is a single stage fully reusable chemical rocket using LO₂/LH₂ propellants. In operation, round trip hydrogen will be loaded at the low lunar orbit (LLO) propellant depot while round trip oxygen would be loaded on the lunar surface.

Lunar resource utilization Concept D employs a lunar derived rocket (LDR) for

transfer of cargo and personnel from the lunar surface to low lunar orbit. The LDR is a single stage vehicle utilizing lunar derived aluminum and oxygen as propellants. Although LDR propellant consumption is 2.7 times greater than for the LTV, released volatiles are only slightly higher than for Concept C since a large percentage of LDR combustion products are solid aluminum oxides.

PLTV As Start Up Lander —

Lunar resource utilization Concept B does not include a heavy cargo transfer vehicle for operation between the lunar surface and low lunar orbit which would be available for start up equipment deliveries. However, it appears that the PLTV can serve this purpose if operated in a zero payload up mode. Utilized in this manner, the PLTV can deliver a 68 ton payload to the lunar surface. Cargo would be carried on side mounted pods. In order to provide adequate throttle control, the total engine thrust should be uprated to 285 kN.

4.6.4 Vehicle Requirements Summary

Vehicle sizing for LRU systems Concepts B, C and D was accomplished by considering interrelated parameters of vehicle payload capacity, launch frequency, and total fleet requirements. The given information is total annual payload for each transfer leg to support construction of one 10 GW SPS. This information is contained in the steady state material requirements logistics scenarios. The annual payload is calculated by multiplying the quantities/10 units of SPS shown in the logistic scenarios by one tenth the SPS mass, which is equal to 9,838 T for an SPS constructed using 89.6 percent lunar materials.

Table 4-55 identifies the vehicles required to perform steady state operations for each concept. Vehicle requirements for start-up and replacement at end of life have not been included here.

All COTV configurations employ ion electric propulsion systems with oxygen pro-

pellant. A modular arrangement will most likely be adopted to permit construction of the desired COTV configuration with standard array segments, thruster clusters, oxygen tankage, and structural framework. The numbers in parenthesis preceding the thruster quantity refer to the transfer leg (leg (1) for Concept B was deleted due to an insignificant payload requirement). The parenthetical numbers following are the payload mass transfer capability.

LRU Concept B exhibits the lowest total vehicle quantity but the largest number of vehicle types. The mass catcher and terminal tug have been combined into a single vehicle, the self propelled mass catcher. In addition, the POTV and PLTV vehicles probably have many common elements and should not be counted as two separate vehicles. This commonality should reduce LRU Concept B vehicle types to six, only one more than required for Concepts C and D.

Table 4-55. Vehicle Requirements Comparison.

	B		C		D	
	Type & size	Qty	Type & size	Qty	Type & size	Qty
Earth launch	SDV	2	SDV	3	SDV	2
	Space shuttle	2	Space shuttle	2	Space shuttle	2
COTV	Ion electric (O ₂) (2) 240 thrusters (118 T)	2	Ion electric (O ₂) (1) 1,120 thrusters (5,293 T)	2	Ion electric (O ₂) (1) 1,120 thrusters (5,293 T)	2
	(3) 2,740 thrusters (6,578 T)	2	(2) 5,512 thrusters (2,540 T)	5	(2) 5,500 thrusters (2,328 T)	3
	(4) 5,880 thrusters (32,865 T)	3	(3) 5,400 thrusters (29,678 T)	3	(3) 5,400 thrusters (29,678 T)	3
POTV	Chemical (LO ₂ & LH ₂)	3	Chemical (LO ₂ & LH ₂)	2	Chemical (LO ₂ & LH ₂)	2
Lunar launch	Mass driver cat.	1	LTV (LO ₂ & LH ₂)	7	LDR (LO ₂ & Al)	7
	PLTV (LO ₂ & LH ₂)	1				
Other	Mass catcher/ TT	2				
Total vehicle quantity		18		24		21
Distinct vehicle types		7		5		5

4.7 LRU MATERIAL CHARACTERIZATION

SPS construction material was characterized in terms of its composition, packaging, and the quantity transferred between the mining location on the moon and the manufacturing location in-space. Materials are required from both the earth and moon. Lunar material requirements were developed based on the updated quantity of 105,650 T needed for completed SPS parts plus the lunar derived propellants needed to deliver lunar and earth supplies. Propellant requirements were obtained from the steady state material logistics scenarios. The following assumptions were used in obtaining these material requirements.

- 1) The maximum recovery of any single element from lunar soil is 50 percent.
- 2) Highlands soil element percentages were used due to the quantity of aluminum (relative to iron) required.
- 3) Beneficiated iron recovery via magnetic separation of 0.15 percent was used. Remaining iron requirements were provided by electrolysis of molten lunar soil and subsequent refining.
- 4) A 5 percent material loss due to initial beneficiation was used for Concept B. This removal of the large lithic fragments occurred prior to material transport to the SMF via mass driver catapult.

Lunar materials needed for each LRU systems concept are listed in Table 4-56.

The total lunar material mined quantity shown does not agree with the quantity derived in the steady state material logistics scenarios. This is due to the application of different assumptions during their derivation. Recovery values used for EMR/LMR assessment in steady state logistics scenarios were 75 percent for oxygen and 100 percent for aluminum. As indicated in assumption 1), data in Table 4-56 was prepared assuming a 50 percent maximum recovery of any single element. Although material quantities differ due to these recovery percentages, the comparative assessment of the three LRU system concepts is not appreciably influenced by this recovery percentage variation.

Table 4-56. Lunar material requirements per 10 GW SPS.

Total Lunar Material Mined	Sys Concept B		Sys Concept C		Sys Concept D	
	Mass (T)	Element Percent Recovered	Mass (T)	Element Percent Recovered	Mass (T)	Element Percent Recovered
	384,700		507,800		1,145,900	
Native Glass	34,690	47	34,690	34	34,690	15
Beneficiated Fe	550	27	760	19	1,720	8
Processed Fe	3,910		3,700		2,740	
Processed O ₂	39,250	27	105,510	50	174,500	35
Processed Si	34,830	50	34,830	35	34,830	15
Processed Al	12,280	28	12,280	20	73,900	50
Total useful material required	125,510	33	191,770	38	322,380	28

LRU Concept C and D steady state requirements are very insensitive to lunar operations, since processing occurs on the lunar surface and processing chemicals are the only deliverable item effected. The same is true for Concept B, even though processing occurs at the SMF, since material transfer from moon to SMF is accomplished with the mass driver catapult. The mass driver uses no chemical propellant, and the catcher/tug requires very little, making this transfer relatively insensitive to the material quantity transported.

It is interesting to note that each concept has a unique element recovery requirement which determines the material mined quantity. Silicon for SPS solar cells in Concept B, oxygen for LTV and COTV propellant in Concept C, and aluminum for LDR fuel in Concept D dictate total material requirements. Sufficient quantities of other elements are available in the mined material so that element recovery requirements rarely exceed 35 percent (only native glass in Concept B).

Earth material requirements include various SPS components such as electronics assemblies and special metal parts, alloying materials, plus cooling fluids and processing chemicals. Total annual earth supplied material was estimated at 12,490 T, of

which only 4 percent represented unrecoverable cooling and processing supplies. Specific emphasis was placed on defining requirements for water, since most earth manufacturing operations utilize large quantities of H_2O for cooling, washing, and other purposes. Due to the processing techniques postulated for in-space manufacturing, very little water is required. Estimated annual H_2O resupply due to processing and cooling system losses was approximately 300 T. An initial SMF water supply of 1000 T was estimated. Additional water for personnel drinking and washing was included in the 0.8 T/year of consumables allocated for each space worker.

Material characterization for Concept B involves lunar surface activities which are limited to material mining, beneficiation, packaging, and launch. Additional beneficiation and all SMF product and propellant related processing and manufacturing operations occur at the space manufacturing facility. This results in an accumulation of waste material (slag) at the SMF, which is useful as radiation shielding. This transfer of large quantities of excess material from lunar surface to SMF can only be justified if a catapult and retrieval system like the mass driver/mass catcher is employed. Conventional rocket transfer methods would result in unacceptable propellant consumption requirements.

As depicted in Figure 4-54, lunar surface operations consist of mining, and beneficiation to remove the large lithic fragments and separate out native lunar glass. This native glass is used to produce the woven glass bags which serve as packaging for mass driver "payloads." Some limited chemical refining may be required for the glass bag manufacturing operation, and if an aluminum coating for electrostatic guidance is desired on the bags, some processing will also be necessary. Lunar soil is packed into these bags and catapulted from the moon. These mass driver payloads are retrieved by the mass catcher, an action which results in rupture of the woven glass containment bags. A catcher ion-electric propulsion system, using oxygen propellant supplied by the SMF, transfers accumulated material to the SMF.

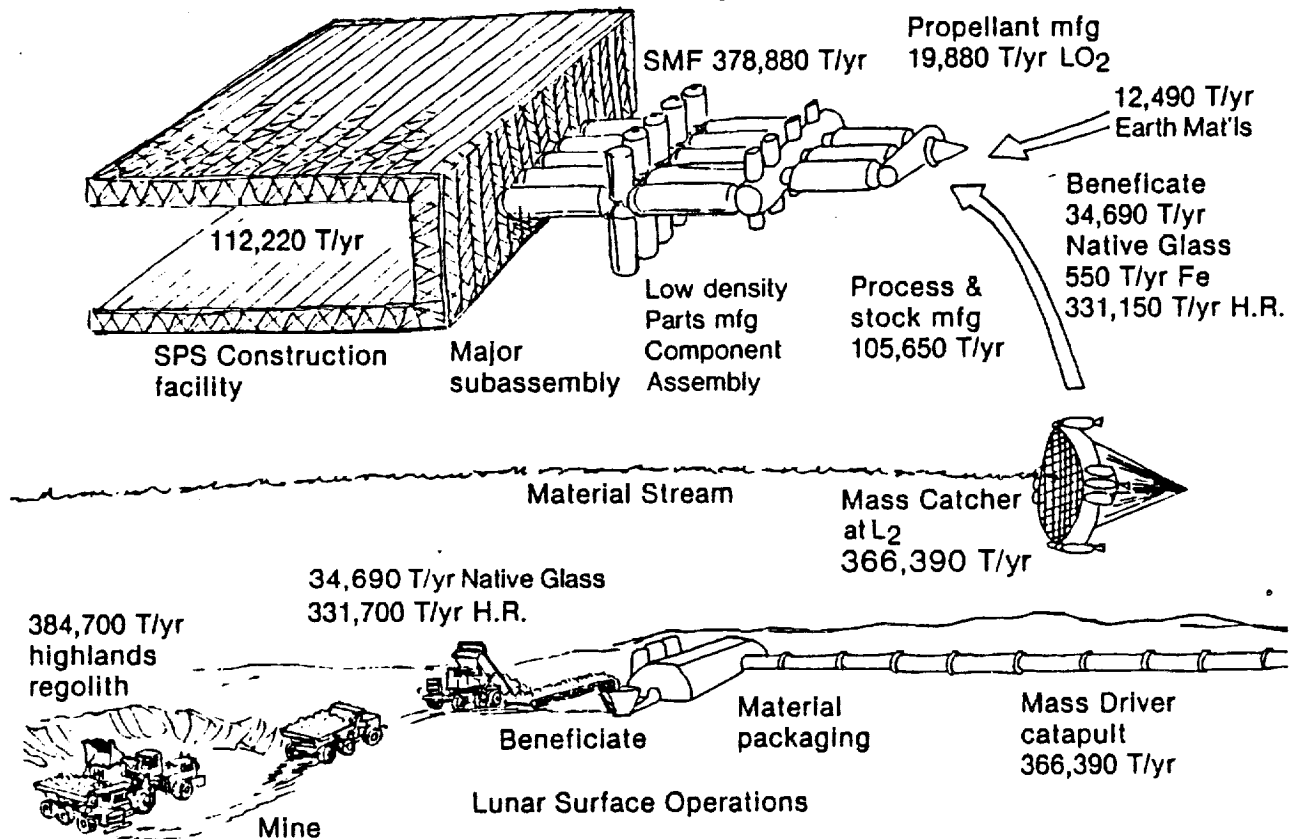

Figure 4-54. Material characterization for LRU Concept B.

At the SMF, beneficiation operations are repeated to recover the native glass bag material and separate out free iron. All subsequent processing, propellant manufacturing, stock production, parts manufacturing, and SPS fabrication occur at the SMF. The recovered native glass is reused to produce foamed glass structural members for SPS.

Of the original 384,700 T mined on the moon, 18,310 T remains on the lunar surface and 366,390 T is delivered to the SMF. From this is produced 125,530 T of useful products and 240,860 T remains as slag. Unrecoverable losses during subsequent manufacturing and assembly operations result in an additional accumulation of 5,920 T, some of which is from earth delivered materials. Thus total SMF slag production is 246,780 T per SPS. Shielding requirements for the SMF habitat have

been estimated at 85,500 T, approximately a 4 month slag supply at the assumed production rate of one SPS/yr.

Material characterization for Concept C involves processing on the lunar surface to remove most of the unwanted material (slag), prior to space delivery with chemical rockets. This circumvents the inefficient process of utilizing large quantities of rocket propellant to lift unneeded material into space. Lunar surface processing involves beneficiation to recover free glass and iron. Separation of aluminum or iron rich soils is not required for Concept C since the driving element recovery requirement is oxygen (for propellant), which is equally prevalent in all soils. For Concept D, additional beneficiation to obtain aluminum rich soils would be desirable, since aluminum propellant needs are the key driver.

As shown in Figure 4-55, lunar surface processing includes production of metallurgical grade iron and aluminum (some earth alloying materials may be added), some metallurgical grade silicon (for high quality silica glass), highly purified silicon (for solar cells), and liquid oxygen. Native lunar glass for subsequent manufacture of foamed glass is obtained directly from beneficiation of the lunar soil. Of the original 507,800 T highlands regolith, 191,790 T useful material is retained and 316,010 T remains on the lunar surface as slag.

Lunar surface stock manufacturing output consists of high density metal products including rolls of 1m wide aluminum sheet and 7 cm and 16 cm wide steel sheet, coils of aluminum wire, and aluminum and sendust castings. Nonmetallic products include spools of glass fiber and marbles of high purity SiO_2 . These products, plus bags of native glass, ingots of refined silicon, and containers of liquid oxygen comprise the LTV payload. All payload items are loaded into LTV payload canisters of 155 T capacity and launched in pairs. Most of the LO_2 is used as LTV propellant, only 24,000 T is payload for delivery to LLO. In LLO, the containerized payloads are transferred from LTV to COTV for the trip to GEO. LO_2 payload is distributed to GEO and LEO depots

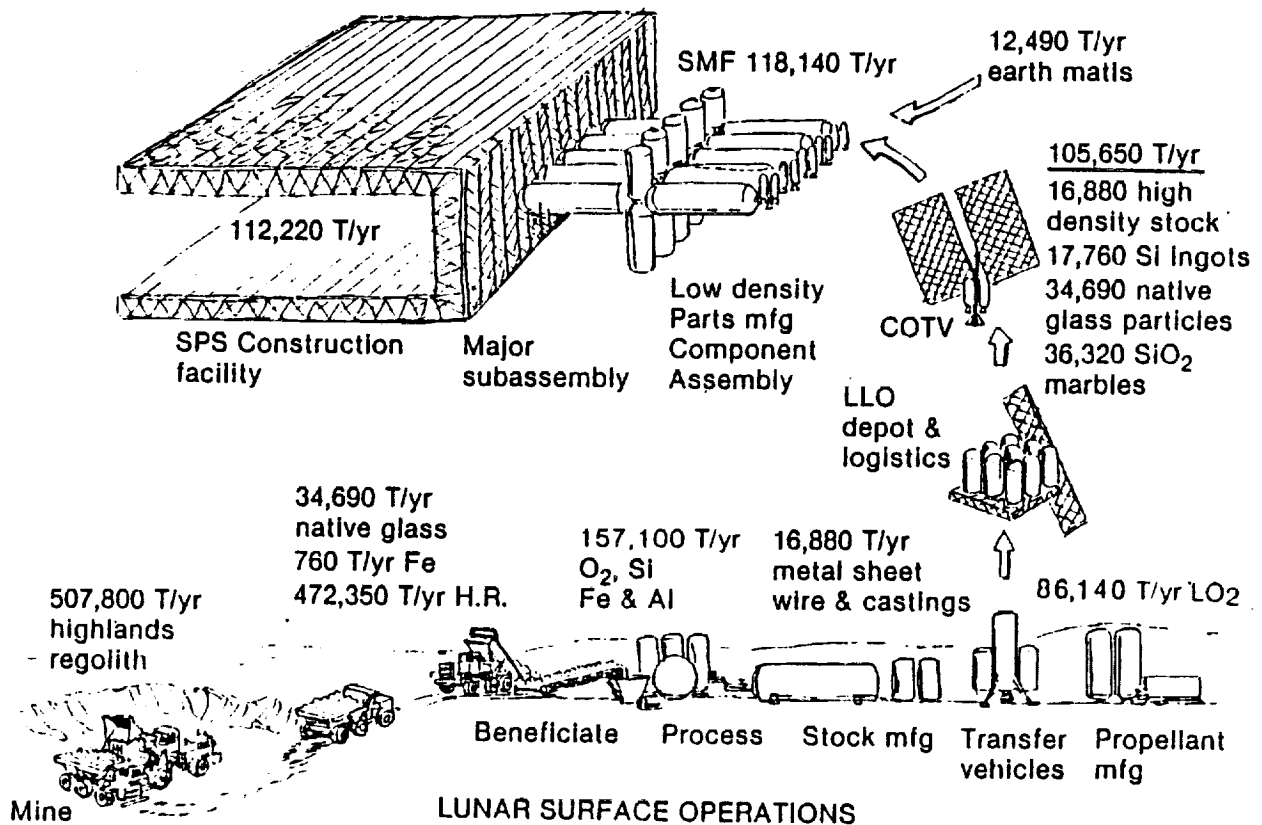

Figure 4-55. Material characterization for LRU Concept C.

by COTV, and some remains at the LLO depot. At the SMF in GEO, dense materials and products are manufactured into low density parts, components, and subassemblies; and fabricated into the SPS. Many of these parts should be manufactured only at the SMF due to their very low density (foamed glass structure) or fragility (silicon solar cell panels). Delivery of these manufactured parts from the lunar surface would result in extremely difficult packaging and handling problems.

LRU Concept D is similar to Concept C except a larger quantity of regolith is mined, beneficiated, and processed on the lunar surface to supply the oxygen and aluminum LDR propellants required to launch the 105,650 T of SPS construction materials into low lunar orbit.

4.8 LRU START-UP LOGISTICS

Start-up for any LRU concept involves delivering all space facilities, vehicles, initial supplies, initial propellants, and personnel to their proper locations, and placing them on operational status to support steady state production. Start-up phase accomplishment for an in-space manufacturing scenario may have a significant effect on total program cost due to its early funding requirements. It may also influence the design and production requirements for launch or orbital transfer vehicles, since start-up material transfer rates may exceed those for steady state operations.

The equipment which must be delivered from earth into space and placed on operational status is identified in Tables 4-57 and 4-58 for LRU Concept B and LRU Concepts C & D respectively. Vehicles and propellants for delivery of these facilities must also be delivered from earth. We have conservatively assumed that all propellants required during start-up operations are delivered from earth. In addition, all initial depot propellant supplies to support steady state operations are also obtained from earth, except for SMF depot oxygen in Concept B, and the LLO depot oxygen in Concepts C & D. Some of these start-up and initial propellant supplies could conceivably be derived from lunar resources during the latter part of the start-up period, significantly reducing earth payload requirements.

One significant change has occurred in the assumptions used for start-up, and those previously used to develop steady state material requirements. Facility requirements estimates for Concepts C & D indicated that even though material processing and stock manufacturing were performed on the lunar surface, a large SMF facility was still required to produce solar cells, subassemblies, and fabricate the SPS. This improved understanding of facility requirements led to a reallocation in personnel assignments. It was previously assumed that 1,565 people were required to produce solar power satellites; 1,365 at the lunar base and 200 at the SMF. Due to better understanding of

production and facility requirements, personnel support facilities have been revised to 400 at the lunar base and 1,165 at the SMF. This is the same total previously assumed, and the higher SMF crew percentage will slightly reduce the steady state propellant requirements needed to transport and sustain these personnel. The temporary shelters in LLO and LEO support transient personnel or maintenance crews during steady state operations and have no (or very few) assigned inhabitants. During start-up, however, the LEO station will provide a base for assembling ion electric COTV's and performing other logistics functions.

Crew requirements for Concept B have remained unchanged from those used for the earlier development of steady state material requirements. All processing and manufacturing is still accomplished at the SMF, so 94 percent of all personnel are stationed there, with the remaining people split between the lunar mining base (48 people) and the GEO maintenance station (36 people).

4.8.1 Start-Up Mass Estimates

Facility sizing information for mining, beneficiation, processing, manufacturing, propellant production, propellant storage depots, power stations, habitats, and transportation vehicles was derived from steady state material logistics scenarios, and is described in Subsections 4.4, 4.5 and 4.6 of this volume. In addition to these defined facilities, other items were also accounted for in our start-up mass estimates such as pressure shells for housing production equipment, and radiators for waste heat rejection. The sizing assumptions used for this equipment plus other guidelines for obtaining LRU start-up estimates are included in the following paragraphs.

Power Plants — Nuclear fission reactors with Brayton cycle generators have been assumed for lunar surface application with all three LRU concepts. Selection of nuclear power rather than solar eliminated the energy storage problem associated with the 336 hour lunar night. Of the three LRU concepts, B is least sensitive to this

Table 4-57. Concept B Start-up Phase.

Location	Material Facilities	Propellant Facilities	Personnel Facilities
Lunar Surface	Mining & Initial Benef. Glass Bag Mfg. Material Handling & Mass Driver Catapult	LO ₂ /LH ₂ Depot (Personnel Transfer)	48 Person Lunar Base
LLO	—	LO ₂ /LH ₂ Depot	12 Person Temp Shelter
SMF	Beneficiation Process & Refine. Dense Stock Mfg. Parts Mfg Component Mfg Foamed Glass Solar Cell Mfg SPS Assembly (Mass Catcher Base)	Oxygen Liquifaction LO ₂ /LH ₂ Depot	1365 Person Habitat
GEO	—	LO ₂ /LH ₂ Depot	36 Person Habitat
LEO	(COTV Assy Fixture)	LO ₂ /LH ₂ Depot	75 Person Temp Shelter

power source selection since its requirements are lowest, and mining and mass driver utilization are amenable to daylight operational restrictions. All in-space power plants are assumed to be solar photovoltaic for all three LRU concepts.

Radiators — Although heat rejection capability has been included in material processing facility and habitat mass estimates, it has not been specifically included for other facilities. To account for the heat rejection requirement, radiator masses of 20 T/MW and 30 T/MW have been used for in-space and lunar surface applications respectively. It was assumed that 50 percent of the total power requirement at each location is waste heat which must be radiated away.

Table 4-58. Concepts C&D Start-up Phase.

Location	Material Facilities	Propellant Facilities	Personnel Facilities
Lunar Surface	Mining & Benef. Process & Refine. Dense Stock Mfg (Metal Sht, Wire, Castings & Glass Filament)	Oxygen Liquefaction LO ₂ Depot Alum Depot (D only)	400 Person Lunar Base
LLO	—	LO ₂ /LH ₂ Depot	12 Person Temp Shelter
GEO	Component Mfg Foamed Glass Solar Cell Mfg SPS Assembly	LO ₂ /LH ₂ Depot	1165 Person Habitat
LEO	(COTV Assy Fixture)	LO ₂ /LH ₂ Depot	75 Person Temp Shelter

Pressure Shells — Many lunar surface and in-space processing/manufacturing/assembly operations should be located within pressurizable containers to accommodate personnel for control, supervisory, or maintenance functions. Shuttle and SDV external hydrogen tanks have been selected for this application. ET LH₂ tank quantity requirements have been estimated by assuming an average manufacturing equipment density of 0.5 T/m³ and 25 percent utilization of an ET tank's volume, which is 1520 m³.

$$\text{ET's Req'd} = \frac{\text{Equipment Mass}}{(0.5) (0.25) (1520)} = \frac{\text{Equipment Mass}}{190}$$

Some discretion was used in selecting those facility items which would be likely candidates for location within a pressure shell. Generally, only a small percentage of processing and refining equipment would require encapsulation, while most fabrication equipment

would benefit from easy personnel accessibility. Mass was estimated at 29.16 T/ET, which includes 14.4 T for the hydrogen tank and the remainder for ECLSS modules, basic internal furnishings, and utility services.

Start-up Personnel — Initial start-up operations are confined to LEO where COTV's are assembled and their early payloads accumulated and integrated. Build-up at most other locations will be approximately linear, starting with the minimum crew size needed to assemble equipment, and completing the start-up period with a full complement of personnel to support steady state operations. Thus, for most activity locations an average (50 percent) crew is assumed for the start-up manned activity duration. In certain instances (concept B's lunar base) the entire steady state crew may be needed to construct and checkout facilities. A mass of 0.393 T/person times the number of trips is used, which accounts for personnel food, clothing, and the transfer module mass.

Start-up Lunar Propellant Supplies — Sufficient propellants are stored on the lunar surface during start-up to permit transfer of all personnel from the moon to low lunar orbit. For Concept B, an extra PLTV is included to provide a back-up personnel transfer vehicle. Steady state operations require 7 LTV's for Concepts C and D which should provide sufficient contingency capability for start-up operations.

Concept D Lunar Fuel Depot — LDR aluminum propellant is stored on the lunar surface in LDR fuel canisters capable of holding ~100T of powdered aluminum each. Each canister has a mass of 0.73 T and 60 are required to provide storage for one full month of steady state operations. This is equivalent to 43.7 T of aluminum storage tankage which is combined with 274.6 T of LO₂ storage modules to yield a total lunar surface depot mass of 318 T.

SPS Assembly Fixtures — The mass for this facility was obtained by combining the LEO and GEO SPS assembly fixture masses from the NASA-JSC Earth Baseline Brochure

(1-25-78) and deleting the habitat masses which have been accounted for separately.

Detailed start-up mass estimates for LRU Concepts B, C, and D are included in Tables 4-59, 4-60 and 4-61 respectively. Condensed tabulations of these start-up mass estimates are presented in Tables 4-62, 4-63 and 4-64 and pictorially represented in Figures 4-56, 4-57 and 4-58 for LRU Concepts B, C, and D respectively. As indicated by these tables and figures, the total earth payload required for start-up varies from 128.0 kT for Concept B to 260.1 kT for Concept D. Material facilities are the most massive payload requirement for Concept B, followed by initial propellant supplies and depots and vehicles. Propellant requirements for Concepts C and D constitute the major payload category, followed by material facilities and depots and vehicles. Start-up personnel requirements for Concept B are lower than those for C and D since six month duty tours are feasible at the SMF due to readily available radiation shielding.

A summary comparison of start-up mass requirements for the three LRU system concepts and the reference earth baseline is contained in Table 4-65. All LRU concepts have start-up mass requirements 5 to 10 times that of the reference earth baseline. Comparison of the three LRU options shows lower mass requirements for Concept B in all categories except habitats. This is due to an assumption that the Concept B SMF habitat will provide radiation protection and pseudo-gravity to support six month activity tours. Personnel estimates were based on nominal duty tours with a linear crew increase to steady state populations at the end of start-up. It was assumed that the lunar base would be established the first year (3 year build-up), followed by the SMF a year later (2 year build-up).

In addition to the earth supplied start-up facilities, 6,000 T of raw lunar material is required at the GEO habitat in LRU Concepts C and D to shield two 600 person solar flare shelters. Transfer vehicle propellants for 20 LTV flights and one COTV₃ flight have been included to provide this shielding. Lesser requirements are similarly accounted for in Concept B.

Table 4-59. Concept B Start-up Estimate.

<u>LUNAR SURFACE</u>	(T)	(MW)
Mining Equipment	125	0.015
Beneficiation Equip	9	0.005
Glass Bag Mfg Facility	160	0.8
ET Tanks & Modules (2 ET)	58	0.02
Mass Driver Catapult	314	39.3
Mat'l Handling Facility	75	0.5
Temporary Shelter (12 people)	30	—
Habitat 48 People (6 mo)	185	0.5
Personnel (48 People Avg 2 1/2 yrs)	95	—
Power Station (50 MW) (Nuclear Assumed)	254	41.14
Propellant Depot (POTV + Reliq)	15	
Initial Prop. Supply (Personnel Xfer)	60	
	<u>1380</u>	
Propellant to Land Equipment		
LLO → Moon (0.691)	<u>954</u>	
(ℙ Down + Stg Return) (PLTV)	<u>2334</u>	
<u>LOW LUNAR ORBIT</u>		
PLTV's (2)	10.2	
Temporary Shelter (12 People)	52	
Propellant Depot	31.2	
Initial Prop. Supply (6 Mo)	64.5	
PLTV LLO → Moon (5 Flts Full)	224	(×1.52)
POTV LLO → LEO (5 Flts 75% Full)	207	(×1.87)
	<u>589</u>	
TOTAL TO LLO	2923	
Propellant to Deliver	<u>1407</u>	2828
LEO → LLO (1.87) Personnel		(5 Flts Full)
Cargo (0.4 Round Trip)	4330	1131 276

Table 4-59. Concept B Start-up Estimate (continued).

<u>SMF (2:1 RESONANCE ORBIT)</u>	(T)	(MW)
Beneficiation Equipment	18	0.01
Processing Facility	1775	331.0
Stock Manufacturing	173	20.5
Parts Manufacturing	1308	3.9
Component Assy Facilities	185	0.41
Silicon Refining	5900	19.36
Silicon Cell Production	16150	239.04
SPS Assembly Fixtures	8568	Incl
ET Tanks & Modules (136 ET)	3967	1.36
Process Chem & Supplies (1 yr)	1655	—
Mfg Facility Radiators	6500	4.29
Liquefaction Plant	76	Incl
Propellant Depot	350	Incl
Initial Prop Supply (LH ₂)	480	
Catcher Prop L ₂ → SMF	1720	
POTV Prop SMF ₂ → LEO Xfer (2.1)	2312	
COTV Prop SMF → GEO (Shielding)	39	
Habitat 1365 People (86 ET)	7853	13.5
Personnel (700 People Avg 2 Yrs)	1101	
Power Station (650 MW) (Solar photovoltaic)	5030	633.4
Vehicles		
Mass Catchers (2)	6000	
COTV ₄ (3) Bring Themselves	—	
	<u>71160</u>	
Propellant to Deliver		
LEO to SMF Cargo (0.35 RT)	24521	(70059 T)
Personnel (2.1)	2312	(1101 T)
	<u>97993</u>	
<u>GEO MAINTENANCE FACILITY</u>		
Propellant Depot	31.2	Incl
Initial Propellant	93.5	—
POTV GEO → LEO (2.2)	62.3	—
Habitat 36 People (3 mo)	242.1	Incl
Personnel (18 People Avg 1 Yr)	28.3	—
Flare Shelter (650 T from SMF)	3.4	—
	<u>461</u>	
Propellants to Deliver		
LEO to GEO Cargo (0.245)	106	(432.5 T)
Personnel (2.2)	63	(28.3 T)
	<u>630</u>	

Table 4-59. Concept B Start-up Estimate (continued).

<u>LOW EARTH ORBIT</u>		(T)	
COTV Assy Fixture		200	
Habitat (75 People)		604	
Propellant Depot		259	
Initial Prop Supply (6 Mo)		3846	
Space Vehicles			
COTV ₂ (LEO → GEO) Qty 2		408	
COTV ₂ (LEO → LLO) Qty 2		4658	
COTV ₃ (LLO → GEO) Qty 3		14994	
POTV ₄ (All) Qty 11 Enough to Return Median Crew		74	
		<u><u>25043</u></u>	
Total Payload to LEO		127,996	
Cargo Facilities	85075	} 615 SDV Launches	
Cargo Propellants	38471		
Personnel	1224	42 Shuttle Launches	
External Tanks (224)	3226	(No Charge)	
	<u>Total</u>	<u>LO₂</u>	<u>LH₂</u>
COTV Propellants	25797	25387	410
POTV & PLTV Propellants	6410	5609	801
Depot Propellants	4544	3349	1195
Catcher Propellants	<u>1720</u>	<u>1595</u>	<u>125</u>
	38471	35940	2531

Table 4-60. Concept C Start-up Estimate.

<u>LUNAR SURFACE</u>	(T)	(MW)
Mining Equipment	250	0.03
Beneficiation Equip	27	0.01
Processing Facility	2905	436
Liquefaction Plant	486	10.8
Stock Manufacturing	173	20.5
Parts Manufacturing	5	0.04
Silicon Refining	5900	19.36
ET Tanks & Modules (24 ET)	700	0.24
Process Chem & Supplies (1/2 Yr)	1660	—
Mfg Facility Radiators	7500	4.95
Habitat 400 People (12 ET's)	2000	3.6
Personnel (200 People Avg 3 Yrs)	472	—
Power Station (500 MW) (Nuclear Assumed)	1275	495.5
Propellant Depot	154	
Initial Prop Supply (Personnel Xfer)	320	
	<u>23827</u>	
Propellant to Land Equipment LLO → Moon (0.6715)	16000	
Propellant to Launch Shielding 6000 T Moon → LLO	4029	
	<u>43856</u>	
 <u>LOW LUNAR ORBIT</u>		
LTV's (7)	210	
COTV ₃ (3) Bring Themselves	—	
Temporary Shelter (12 Person)	52	
Propellant Depot	796.1	
Initial Prop Supply (3 Mo LH ₂)	2396.3	
POTV LLO → LEO (Crew) (1.87)	883	
COTV ₃ LLO → GEO (Shielding)	1470	
	<u>5808</u>	

Table 4-60. Concept C Start-up Estimate (continued).

	(T)	Cargo	Personnel
<u>TOTAL TO LLO</u>	49664	49192	472
Propellant to Deliver	22060		
LEO to LLO (0.4305)		21177	
(1.87)			883
	<u>71724</u>		
 <u>GEOSYNCHRONOUS ORBIT</u>	 (T)	 (MW)	
Parts Manufacturing	1303	3.9	
Component Assy Facilities	185	0.4	
Silicon Cell Production	16150	239.04	
SPS Assembly Fixtures	8568	Incl	
ET Tanks & Modules (96 ET)	2800	0.96	
Process Chem & Supplies (1/2 Yr)	1660	—	
Mfg Facility Radiators	2600	1.72	
Habitat 1165 People (66 ET)	4460	10.5	
Shielding From Moon Ref	(6000)	—	
Personnel (600 People Avg 2 Yrs)	1887	—	
Power Station (260 MW)	2015	256.5	
Propellant Depot	39		
Initial Prop Supply (6 Mo)	519		
POTV Prop GEO → LEO Xfer (2.2)	4152		
	<u>46338</u>		
 Propellant to Deliver			
LEO to GEO Cargo (0.245)	10891	(44451)	
Personnel (2.2)	4151	(1887)	
	<u>61380</u>		
 <u>LOW EARTH ORBIT</u>			
COTV Assy Fixture	200		
Habitat (75 People)	604		
Propellant Depot	1457		
Initial Prop Supply (6 Mo)	9689		
Space Vehicles			
COTV ₁ (LEO → GEO) Qty 2	1904		
COTV ₂ (LEO → LLO) Qty 5	23425		
COTV ₃ (LLO → GEO) Qty 3	13770		
POTV ₃ (All) Qty 11 Enough to Return	74		
Median Crew			
	<u>51123</u>		

Table 4-60. Concept C Start-up Estimate (continued).

Total Payload to LEO	(T)	184, 227
Cargo Facilities	102457	} 892 SDV Launches
Cargo Propellants	76560	
Personnel	2359	80 Shuttle Launches
External Tanks (198)	2851	(No Charge)

	<u>Total</u>	<u>LO₂</u>	<u>LH₂</u>
COTV Propellants	33538	33005	533
POTV & LTV Prop	30098	26336	3762
Depot Propellants	<u>12924</u>	<u>5323</u>	<u>7601</u>
	76560	64664	11896

Table 4-61. Concept D Start-up Estimate.

<u>LUNAR SURFACE</u>	(T)	(MW)
Mining Equipment	375	0.045
Beneficiation Equip	60	0.034
Processing Facility	5480	885.0
Liquefaction Plant	836	18.6
Stock Manufacturing	173	20.5
Parts Manufacturing	5	0.04
Silicon Refining	5900	19.36
ET Tanks & Modules (30 ET)	875	0.3
Process Chem & Supplies (1/2 Yr)	3974	—
Mfg Facility Radiators	11500	9.5
Habitat 400 People (12 ET's)	2000	3.6
Personnel (200 People Avg 3 Yrs)	472	—
Power Station (960 MW) (Nuclear Assumed)	2450	957.0
Propellant Depot	318	
Initial Prop Supply (Personnel Xfer)	<u>870</u>	
	35288	
Propellant to Land Equip		
LLO → Moon (1.835)	64754	
Propellant to Launch Shielding		
6000 T Moon → LLO	<u>11010</u>	
	111052	
<u>LOW LUNAR ORBIT</u>		
LDR's (7)	500.5	
COTV ₃ (3) Bring Themselves	—	
Temporary Shelter (12 Person)	52	
Propellant Depot	187.5	
Initial Prop Supply (4 Mo LH ₂)	133	
POTV LLO → LEO (Crew) ² (1.87)	883	
COTV ₃ LLO → GEO (Shielding)	<u>1470</u>	
	3226	

Table 4-61. Concept D Start-up Estimate (continued).

	(T)	Cargo	Personnel
<u>TOTAL TO LLO</u>	<u>114278</u>	113806	472
Propellant to Deliver	49877		
LEO to LLO (0.4305)		48994	
(1.87)			883
	<u>164155</u>		
<u>GEOSYNCHRONOUS ORBIT</u>	(T)	(MW)	
Parts Manufacturing	1303	3.9	
Component Assy Facilities	185	0.4	
Silicon Cell Production	16150	239.04	
SPS Assembly Fixtures	8568	Incl	
ET Tanks & Modules (96 ET)	2800	0.96	
Process Chem & Supplies (1/2 Yr)	1660	-	
Mfg Facility Radiators	2600	1.72	
Habitat 1165 People (66 ET)	4460	10.5	
Shielding From Moon Ref	(6000)	-	
Personnel (600 People Avg 2 Yrs)	1887	-	
Power Station (260 MW)	2015	(256.5)	
Propellant Depot	39		
Initial Prop Supply (6 Mo)	519		
POTV Prop GEO→LEO Xfer (2.2)	<u>4152</u>		
	<u>46338</u>		
Propellant to Deliver			
LEO to GEO Cargo (0.245)	10891	(44451)	
Personnel (2.2)	<u>4151</u>	(1887)	
	<u>61380</u>		

Table 4-61. Concept D Start-up Estimate (continued).

<u>LOW EARTH ORBIT</u>		(T)			
COTV Assy Fixture		200			
Habitat (75 People)		604			
Propellant Depot		208			
Initial Prop Supply (6 Mo)		3740			
Space Vehicles					
COTV ₁ (LEO → GEO) Qty 2		1904			
COTV ₂ (LEO → LLO) Qty 3		14025			
COTV ₃ (LLO → GEO) Qty 3		13770			
POTV ₃ (All) Qty 11 Enough to Return Median Crew		74			
		<u>34525</u>			
Total Payload to LEO			260,060		
Cargo Facilities	102313	}	1269 SDV		
Cargo Propellants	152450		Launches		
Personnel	2359		80 Shuttle Launches		
External Tanks (204)	2938		(No Charge)		
	<u>Total</u>	<u>LO₂</u>	<u>LH₂</u>	<u>Al</u>	
COTV Propellants	61355	60379	976		
POTV Propellants	10069	8810	1259		
Depot Propellants	5262	4308	684	270	
LDR Propellants	<u>75764</u>	<u>52235</u>	<u> </u>	<u>23529</u>	
	152450	125732	2919	23799	

Table 4-62. Start-up Mass Estimate for Concept B.

(Mass in metric tons)

	Mat'l Facilities	Habitat	Depots & Vehicles	Propellant	Personnel	Total
Lunar Surface	995	215 [†]	15	60	48 People Avg For 2.5 Yr 6 Month Tours	1,380
XFER	LLO → Lunar Surface			954		954
LLO		52	41	496	(12 Temporary)	589
XFER	LEO → LLO			1,407		1,407
SMF	51,305	7,853	6,350	4,551	700 People Avg For 2 Yr 6 Month Tours	71,160
XFER	LEO → SMF			26,833*		26,833
GEO		246	31	156	18 People Avg For 1 Yr 3 Month Tours	461
XFER	LEO → GEO			169		169
LEO	200	604	20,393	3,846	(75 Temporary)	25,043
Total	52,500	8,970	26,830	38,472	1,224	127,996

[†] Includes temporary 12 person shelter for mass driver maintenance

*Includes propellant to delivery 650T shielding from SMF to GEO

Table 4-63. Start-up Mass Estimate for Concept C.

(Mass in metric tons)

	Mat'l Facilities	Habitat	Depots & Vehicles	Propellant	Personnel	Total
Lunar Surface	20,881	2,000	154	320	200 People Avg For 3 Yr 6 Month Tours	23,827
XFER	LLO → Lunar Surface			20,029*		20,029
LLO		52	1,006	4,750*	(12 Temporary)	5,808
XFER	LEO → LLO			22,060		22,060
GEO	35,281	4,460	39	4,671	600 People Avg For 2 Yr 3 Month Tours	46,338
XFER	LEO → GEO			15,042		15,042
LEO	200	604	40,630	9,689	(75 Temporary)	51,123
Total	56,362	7,116	41,829	76,561	2,359	184,227

*Includes Propellant to Deliver 6,000 T Shielding From Lunar Surface to GEO

Table 4-64. Start-up Mass Estimate for Concept D.
(Mass in metric tons)

	Mat'l Facilities	Habitat	Depots & Vehicles	Propellant	Personnel	Total
Lunar Surface	31,628	2,000	318	870	200 People Avg For 3 Yr 6 Month Tours	35,288
XFER LLO → Lunar Surface				75,764*		75,764
LLO		52	688	2,486*	(12 Temporary)	3,226
XFER LEO → LLO				49,877		49,877
GEO	35,281	4,460	39	4,671	600 People Avg For 2 Yr 3 Month Tours	46,338
XFER LEO → GEO				15,042		15,042
LEO	200	604	29,981	3,740	(75 Temporary)	34,525
Total	67,109	7,116	31,026	152,450	2,359	260,060

*Includes propellant to deliver 6,000T shielding from Lunar Surface to GEO

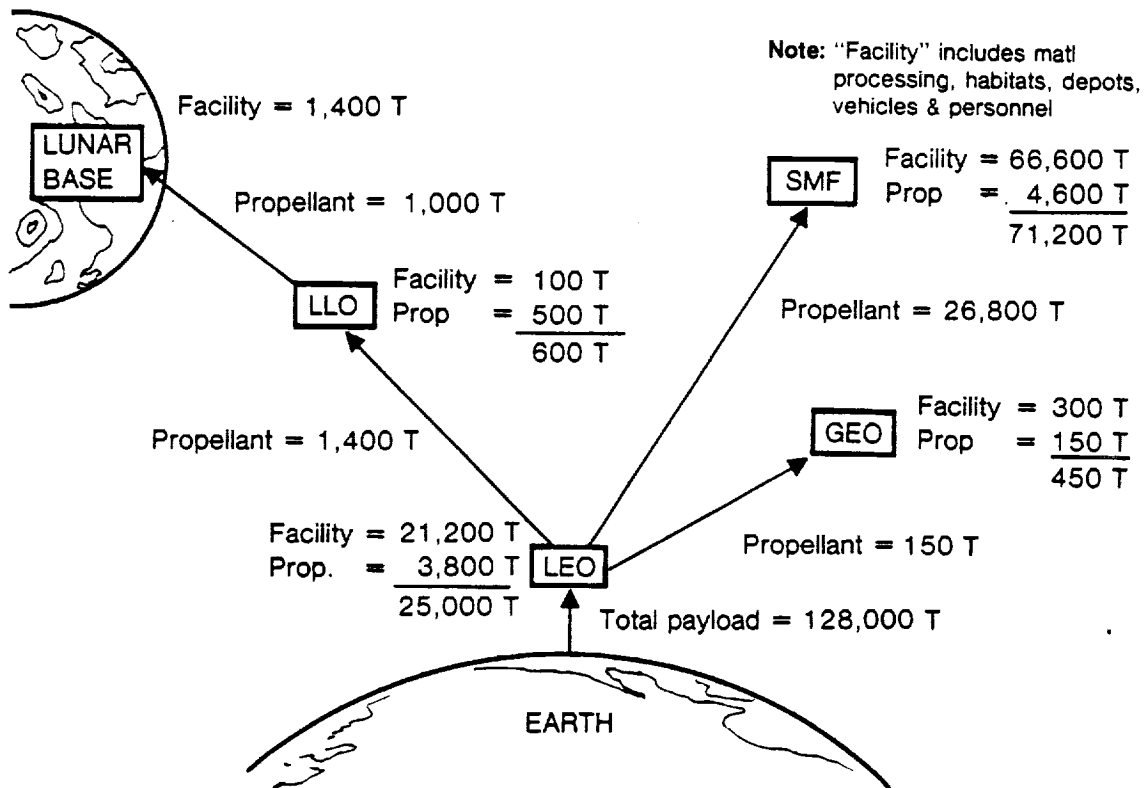

Figure 4-56. LRU Concept B Start-up Payload Requirements.

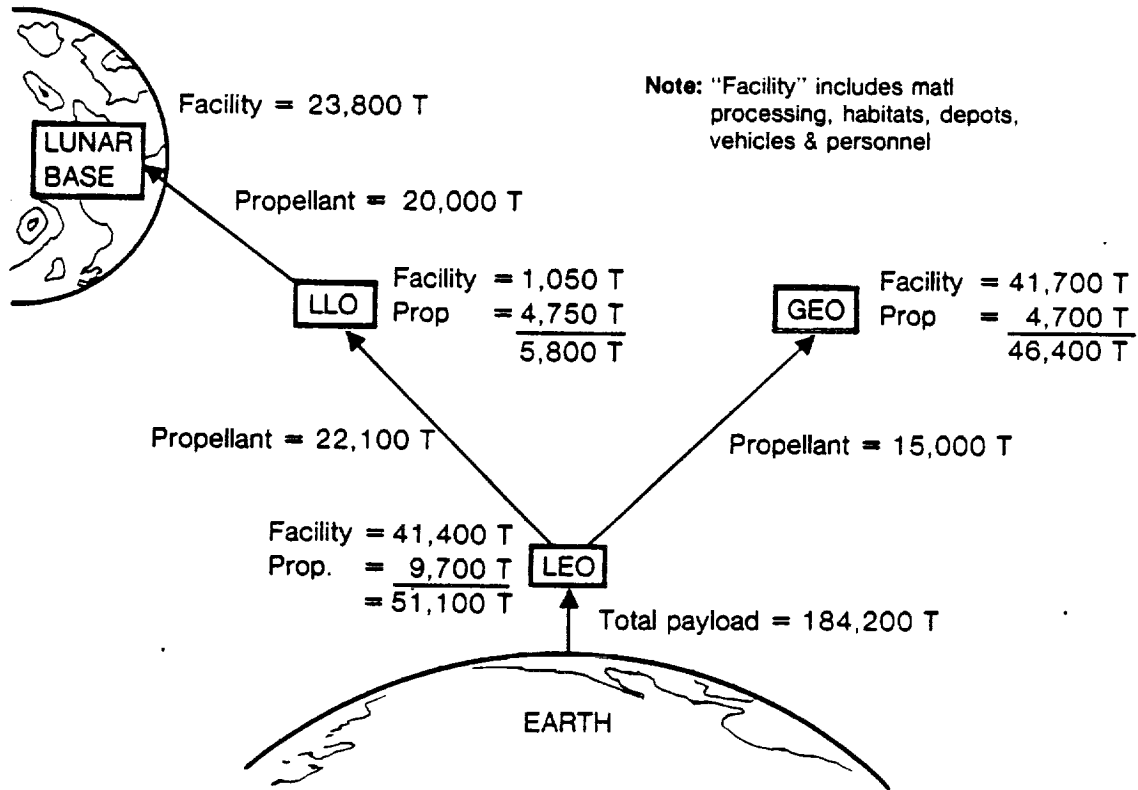

Figure 4-57. LRU Concept C Start-up Payload Requirements.

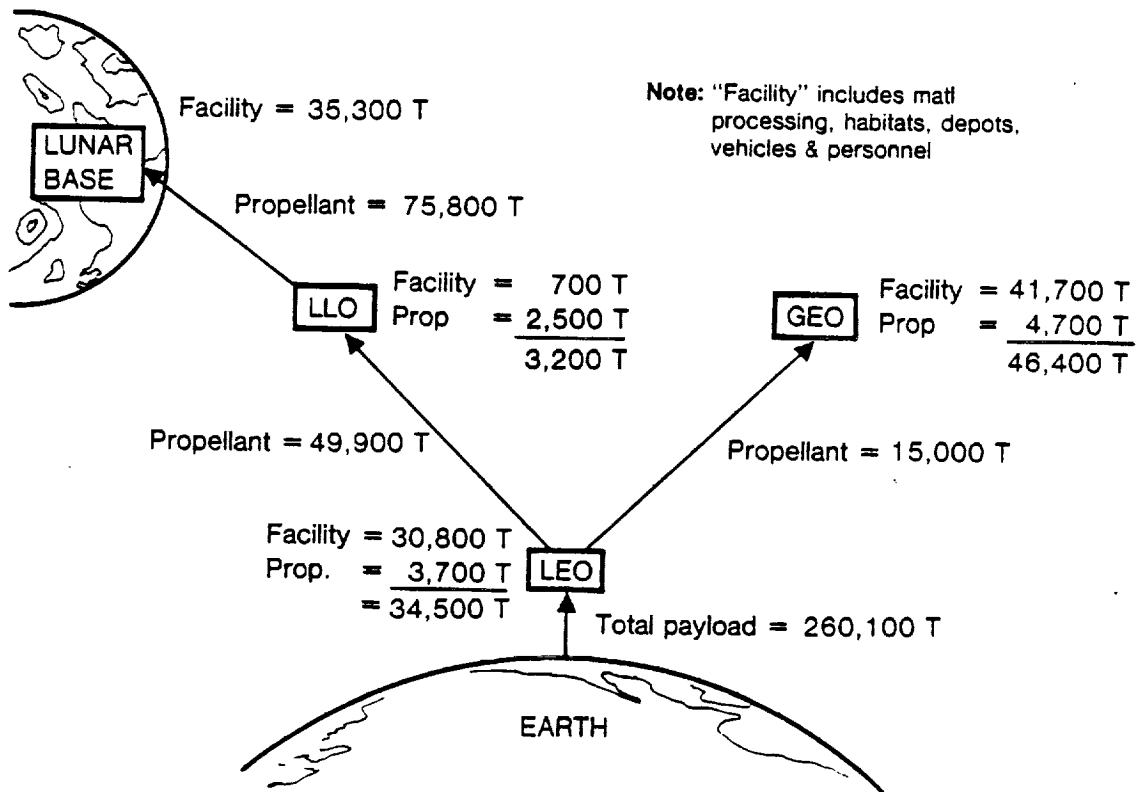

Figure 4-58. LRU Concept D Start-up Payload Requirements.

Table 4-65. Startup Mass Summary Comparison.

(Mass in metric tons)

	Mail Facilities	Habitats	Depots & Vehicles	Propellant	Personnel	Total
Reference earth baseline	Equivalent to 61 HLLV payloads					25,800
LRU Concept B	52,500	8,970	26,830	38,472†	1,224	127,996
LRU Concept C	56,362	7,116	41,829	76,561*	2,359	184,227
LRU Concept D	67,109	7,116	31,026	152,450*	2,359	260,060

† Includes propellant to delivery 650T shielding from SMF to GEO

* Includes propellant to deliver 6,000 T shielding from lunar surface to GEO

4.8.2 Start-up Period and Fleet Sizing Estimates

A three year start-up period was assumed for all three LRU concepts. If the start-up period only considers use of vehicles and fleet sizes consistent with steady state operations, then periods of 2 and 2.5 years might be possible for LRU Concepts B and C. Other start-up logistics considerations, however, such as COTV construction in LEO and checkout of in-space processing and manufacturing facilities, makes the selection of three years more reasonable for each of the LRU concepts investigated. Tables 4-66, 4-67 and 4-68 for LRU Concepts B, C and D respectively, identify the quantity of start-up flights needed for each vehicle, and resulting fleet size requirements for both start-up and steady state operations. The far right column identifies total vehicle requirements including replacement vehicles for those which have exceeded their design life. All chemical propulsion vehicle retirements were based on a 500 mission life, while a 50 mission life was used for ion electric COTV's.

The following description specifically applies to the data shown in Table 4-67 for Concept C, but generally describes the methodology used to obtain vehicle flight and fleet sizing requirements for start-up of all LRU concepts.

The minimum fleet size for start-up assumed the same quantity of vehicles required to support steady state operations. This is sensible since these vehicles must be

Table 4-66. Start-up Operations for Concept B .

Vehicle	Base Location Maint/Prop	Start-up Flights	Nominal Trip Time (Days)	Fleet Size		Vehicles Start-up +30 Yr Ops
				3-Year Start-up	Steady State Ops	
Space Shuttle	Earth	42	14 RT	2	2	3*
SDV	Earth	615	7RT	4	2	6*
COTV ₂	LEO	4	<180 OW	2	2	3
COTV ₃	LEO/SMF	4	<180 OW	2	2	3
COTV ₄	SMF	12	<180 OW	3	3	4
POTV ₄	LEO/all	50	7-9 RT	3	3	3*
PLTV	Moon/LLO	52	7 RT	2	1	1*

*Based on 500 flight life: COTV's assumed life = 50 flights

Table 4-67. Start-up Operations for Concept C.

Vehicle	Base Location Maint/Prop	Start-up Flights	Nominal Trip Time (Days)	Fleet Size		Vehicles Start-up +30 Yr Ops
				3-Year Start-up	Steady State Ops	
Space Shuttle	Earth	80	14 RT	2	2	4*
SDV	Earth	892	7 RT	6	3	9*
COTV ₁	LEO	4	<180 OW	2	2	3
COTV ₂	LEO/LLO	10	<180 OW	5	5	6
COTV ₃	GEO/LLO	9	<180 OW	3	3	4
POTV ₃	LEO/all	82	7-9 RT	2	2	4*
LTV	Moon	97	7 RT	7	7	23*

*Based on 500 flight life: COTV's assumed life = 50 flights

Table 4-68. Start-up Operations for Concept D.

Vehicle	Base Location Maint/Prop	Start-up Flights	Nominal Trip Time (Days)	Fleet Size		Vehicles Start-up +30 Yr Ops
				3-Year Start-up	Steady State Ops	
Space Shuttle	Earth	80	14 RT	2	2	4*
SDV	Earth	1269	7 RT	9	2	8*
COTV ₁	LEO	4	<180 OW	2	2	3
COTV ₂	LEO/LLO	20	<180 OW	3	3	4
COTV ₃	GEO/LLO	9	<180 OW	3	3	4
POTV ₃	LEO/all	82	7-9 RT	2	2	4*
LDR	Moon	138	7 RT	7	7	23*

*Based on 500 flight life: COTV's assumed life = 50 flights

delivered to their use location during start-up anyway. Subsequent evaluation indicated that except for SDV, steady state fleet requirements were adequate for start-up payload delivery. Earth launch of start-up cargo requires 892 SDV flights. Based on nominal steady state 7 day round trip times, 6 vehicles must be available to deliver 179,017 T in 3 years. During 30 years of steady state Concept C operations, a total of $118 \times 30 = 3,540$ SDV launches are required. Total SDV flights for start-up plus steady state equal 4,432 which requires 9 vehicles have a 500 mission design life. To support start-up, six of the nine SDV's are produced and flown on 1 flight/week/vehicle schedules. Following start-up the flight schedule decreases to 1 flight every 3 weeks/vehicle to support steady state operations.

COTV start-up payload delivery missions must be planned so that the COTV ends up at its proper steady state location. Thus COTV₁ and COTV₂ must complete start-up in LEO, while COTV₃ must finish at LLO. COTV₃ will be initially used during start-up for payload delivery to GEO. The schedule for each COTV₃ will probably be:

$$\text{COTV}_3 = \text{LEO} \xrightarrow{1} \text{GEO} \xrightarrow{2} \text{LEO} \xrightarrow{3} \text{LLO} \quad 3(3 \text{ Vehicles}) = 9 \text{ Flights}$$

The COTV₂ and COTV₁ schedules will be one of the following:

$$\begin{aligned} \text{COTV}_2 &= \text{LEO} \xrightarrow{1} \text{GEO} \xrightarrow{2} \text{LEO} && 2(5 \text{ Vehicles}) = 10 \text{ Flights} \\ &\quad \text{LEO} \rightarrow \text{LLO} \rightarrow \text{LEO} \end{aligned}$$

$$\text{COTV}_1 = \text{LEO} \xrightarrow{1} \text{GEO} \xrightarrow{2} \text{LEO} \quad 2(2 \text{ Vehicles}) = 4 \text{ Flights}$$

As shown in Tables 4-66 through 68, the only start-up vehicle requirements which exceed total vehicle requirements are the PLTV in Concept B (for contingency personnel transfer from lunar surface), and the SDV in Concept D, which requires one more vehicle for start-up (9) than is needed to complete the total 30 year program. A slightly longer start-up period of three years and one month will reduce the SDV requirement to 8 vehicles which is consistent with total fleet requirements.

4.8.3 Earth Launched Payload Comparison

Total earth launched payload for start-up plus steady state operations is plotted as a function of time for the earth baseline (Concept A) and LRU Concept B, C & D in Figure 4-59. Start-up payload requirements for LRU Concepts B, C & D occur over a three year period and have been previously identified. Start-up for Concept A is equivalent to 61 HLLV flights in one year, or 26 kT, per the NASA-JSC earth baseline. Steady state earth payload requirements were obtained for 1 SPS/year from the steady state material logistics scenarios developed for both concepts.

$$\text{Concept A Mass/Year} = \frac{15.14 (97,550)}{10} = 147.7 \text{ kT/year}$$

$$\text{Concept B Mass/Year} = \frac{1.38 (98,380)}{10} = 13.6 \text{ kT/year}$$

$$\text{Concept C Mass/Year} = \frac{2.41 (98,380)}{10} = 23.7 \text{ kT/year}$$

$$\text{Concept D Mass/Year} = \frac{1.54 (98,380)}{10} = 15.2 \text{ kT/year}$$

Total mass for start-up plus 30 years of operations:

$$\text{Concept A} = 25.8 + 30 (147.7) = 4,457 \text{ kT}$$

$$\text{Concept B} = 128 + 30 (13.6) = 535 \text{ kT}$$

$$\text{Concept C} = 184.2 + 30 (23.7) = 895 \text{ kT}$$

$$\text{Concept D} = 260.1 + 30 (15.2) = 715 \text{ kT}$$

The earth launched payload cross-over occurs for all three LRU concepts during year two of steady state operations, or a maximum of five years from initiation of LRU start-up. Total earth launched payload for Concept C is the highest for all LRU concepts at 20 percent of the earth baseline after 30 years of operation. This difference is significant even though lunar resources are being recovered and utilized with Concept C but not A. The earth launched payload requirement for lunar resource con-

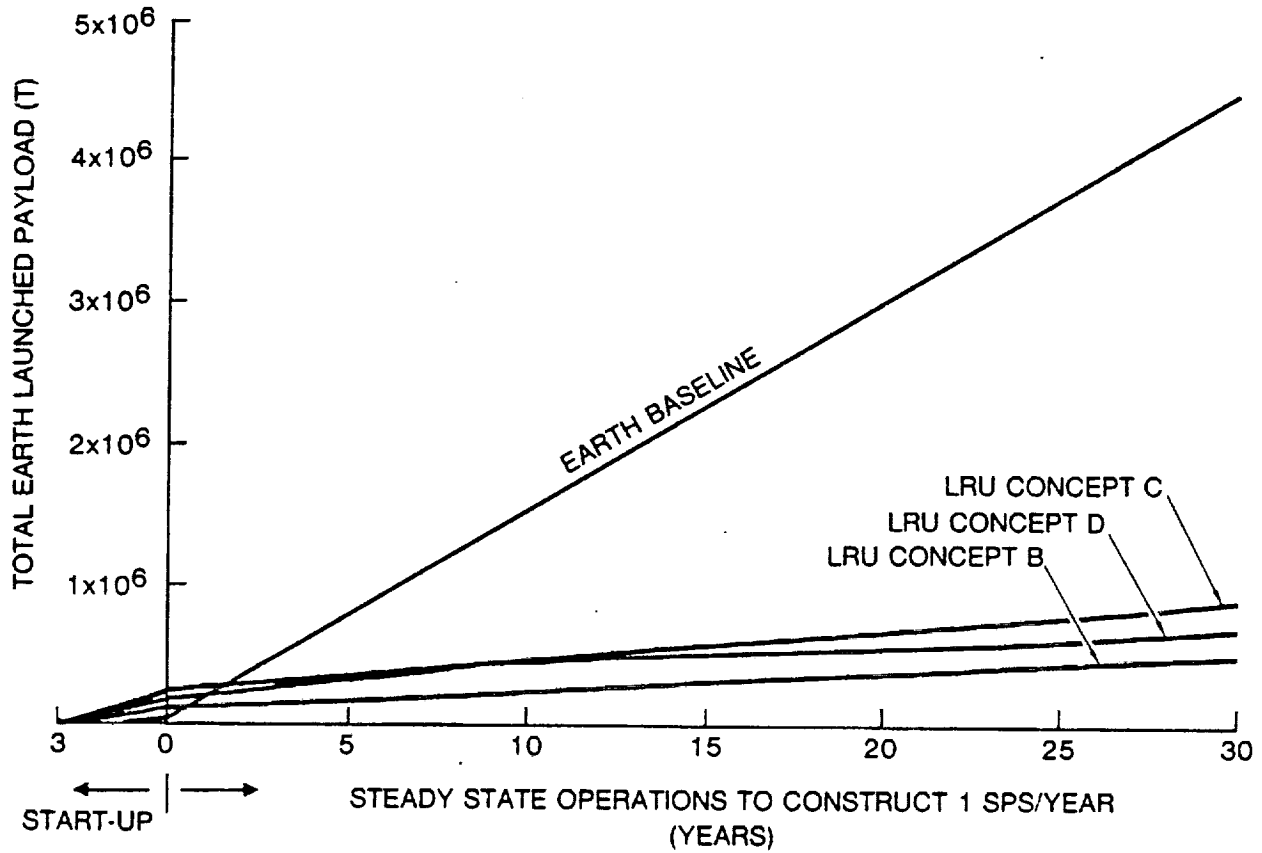

Figure 4-59. Earth launched payload comparison.

cepts does include all non-terrestrial material utilization support elements such as processing chemicals, personnel, life support provisions, and supplies. The lowest earth payload requirement is for LRU Concept B at 12 percent of the earth baseline after 30 years of operation.

4.9 UPDATED IN-SPACE PERSONNEL REQUIREMENTS ESTIMATE

Initial estimates for personnel requirements at in-space activity locations were needed early in the study to develop material requirements scenarios. These crew estimates were grossly derived from earth baseline personnel needs of 480 persons in LEO to manufacture earth delivered satellite components into major SPS modules, and 60 persons in GEO to assemble these SPS modules into complete satellites and perform maintenance. LRU scenario personnel are needed to perform lunar material acquisition, processing, stock manufacturing, and component manufacturing in addition to these earth baseline tasks. By assuming that these additional activities could be highly automated and were inherently less labor intensive than satellite final assembly, a LRU personnel requirements factor of slightly less than 3 was used. Thus, approximately 1500 crew members were allocated to activity locations based on initial assumptions regarding the assignment of manufacturing tasks.

LRU Concept B assumed that all processing and manufacturing was accomplished at the SMF, with lunar activity limited to mining and material transport. This concentration of production personnel at one location appeared to offer certain economies and resulted in slightly lower total crew size requirements than concepts having multiple production locations. Subsequent facility sizing analyses in Subsection 4.5 and Appendix D did not identify any requirement for revising Concept B's initial personnel allocations.

LRU Concepts C and D initially assumed that almost all material processing through component manufacturing operations occurred on the moon, while SMF activities consisted of module subassembly and SPS final assembly. This resulted in a large lunar base population (1,365 people) and modest SMF crew size (200 people). During subsequent definition of manufacturing facility requirements, it became obvious that a large percentage of these lunar facilities should instead be located at the SMF. The SMF location was more desirable for three reasons; 1) the manufactured product was extremely fragile, resulting in difficult packaging requirements for high thrust transfer

from the lunar surface, 2) the manufactured product had very low density resulting in inefficient transfer packaging, and 3) a substantial percentage of the finished product consisted of earth supplied material. For these reasons most of the product and component manufacturing facilities were located at the SMF along with the SPS assembly facilities. This revised the personnel allocation estimate to 400 on the lunar surface and 1,165 at the SMF.

The detailed space facility definitions and start-up mass estimates prepared for the cost analysis and documented in Appendix D of Volume III provide the data needed to update our preliminary personnel estimates. Crew assignments have been consistently made on a system element basis via four work categories:

- 1) Operations - personnel who oversee the automated operation of production equipment and perform routine tasks associated with the manufacturing of materials or products.
- 2) Maintenance - personnel responsible for continuous efficient operation of automated production equipment and support facilities. Perform routine preventive maintenance and repair "down" machinery.
- 3) Support - personnel who oversee those service functions and facilities which are required to meet the physiological needs of space workers. These include food service, sanitation, environmental control, medical staff, janitorial services, communications, recreational programs, etc.
- 4) Supervisory - personnel responsible for the overall planning and operation of space facilities and production programs.

Crew requirements were allocated on a system element basis as shown in Tables 4-69 and 4-70 for LRU Concept B and Concepts C and D respectively. Several guidelines were used in developing the allocations shown:

- a) Three shift operation was assumed for all mining, processing, and manufacturing, and assembly operations.
- b) Supervisory personnel at each activity location were assumed to be approximately 10 percent of the total crew.

- c) Support personnel at each activity location were assumed to be approximately 25 percent of the total crew.
- d) The remaining personnel were distributed between operator and maintenance functions, with a majority associated with maintenance. The preponderance of maintenance personnel is due to the high level of automation assumed for space manufacturing facilities. In addition to the basic automated processing and production equipment, industrial robots have been included for materials handling, machine feeding, and machine unloading tasks. The quantity of robots which perform these routine production tasks and are overseen by operators has been estimated as 1,651, or 3.8 robots for each human operator. For LRU Concept B all of these robots are located at the SMF. Concepts C&D have approximately 30 robots at the lunar base and the remainder (1,621) at the SMF.

The total requirement for in-space personnel obtained from Tables 4-69 and 4-70 is not appreciably different from that initially assumed. Table 4-71 shows a comparison of our initial personnel estimates for EMR development, the revised allocation employed for facility sizing during the start-up analyses and the results of this update based on developing personnel requirements via system element task estimates. Total personnel have increased by 9 percent for Concept B, and 6 percent for Concepts C&D. This corresponds to an earth payload requirement increase of less than one percent for any of these concepts, which is insignificant.

Table 4-69. Concept B Personnel Estimate.

<u>Lunar Base</u>	<u>Operators</u>	<u>Maint</u>	<u>Support</u>	<u>Supervisory</u>	<u>Total</u>
Mine	6	3	1	1	11
Beneficiate	-	1	1	-	2
Glass Bag Mfg } Packaging }	3	3	1	1	8
Catapult	3	6	1	2	12
Power Station	3	3	-	-	6
Habitat	-	4	12	2	18
PLTV	<u>2</u>	<u>1</u>	<u>-</u>	<u>-</u>	<u>3</u>
	17	21	16	6	60

Table 4-69. Concept B Personnel Estimate (continued).

<u>SMF (@ 2:1 Res)</u>	<u>Operators</u>	<u>Maint</u>	<u>Support</u>	<u>Supervisory</u>	<u>Total</u>
Beneficiate	3	1	1	-	5
Process	12	12	3	3	30
Refining	12	18	3	3	36
Stock Mfg	21	21	6	6	54
Parts Mfg	45	54	9	12	120
Component Mfg	33	45	12	12	102
Solar Cells Mfg	66	105	30	30	231
Propellant Mfg	6	15	3	3	27
Sub Assembly } Final Assembly }	225	105	30	40	400
Prop Depot	3	6	1	1	11
Power Station	3	12	5	2	22
Habitat	-	60	240	30	330
POTV's	5	3	3	1	12
COTV's	-	6	3	1	10
Catcher	-	6	3	1	10
	<u>434</u>	<u>469</u>	<u>352</u>	<u>145</u>	<u>1400</u>
<u>GEO</u>					
Sat Maintenance	-	24	9	6	39
Prop Depot	1	1			2
Power Station	1	1			2
Habitat		4	9	1	14
POTV's	<u>2</u>	<u>1</u>	<u>1</u>	<u>1</u>	<u>3</u>
	4	31	18	7	60
<u>LEO</u>					
Prop Depot	3	6	1	1	11
Power Station	1	1			2
Habitat	-	4	9	1	14
POTV's	6	6	1	1	14
COTV's	-	3	1		4
Cargo Handling	<u>9</u>	<u>2</u>	<u>2</u>	<u>2</u>	<u>15</u>
	<u>19</u>	<u>22</u>	<u>14</u>	<u>5</u>	<u>60</u>
Total for Concept B	474	543	400	163	1580
				Initial Estimate	<u>1449</u>
				Δ +	131

Table 4-70. Concepts C and D Personnel Estimates.

<u>Lunar Base</u>	<u>Operators</u>	<u>Maint</u>	<u>Support</u>	<u>Supervisory</u>	<u>Total</u>
Mine	12	6	3	2	23
Beneficiate	3	3	1	1	8
Process	18	18	6	4	46
Refining	12	18	3	3	36
Stock Mfg	21	21	6	6	54
Parts Mfg	6	6	-	1	13
Cargo Handling	15	3	3	2	23
Propellant Mfg	12	18	6	3	39
Prop Depot	3	6	1	1	11
Power Station	3	12	6	3	24
Habitat	-	18	70	12	100
LTV's	<u>6</u>	<u>12</u>	<u>3</u>	<u>2</u>	<u>23</u>
	111	141	108	40	400
<u>SMF (@ GEO)</u>					
Parts Mfg	45	54	9	12	120
Component Mfg	33	45	12	12	102
Solar Cell Mfg	66	105	30	30	231
Sub Assembly	} 225	105	30	40	400
Final Assembly					
Sat. Maintenance	-	24	9	6	39
Prop. Depot	3	3	1	1	8
Power Station	3	9	3	3	18
Habitat	-	45	180	24	249
POTV's	6	6	3	1	16
COTV's	<u>-</u>	<u>9</u>	<u>6</u>	<u>2</u>	<u>17</u>
	381	405	283	131	1200
<u>LEO</u>					
Prop Depot	3	6	1	1	11
Power Station	1	1			2
Habitat	-	4	9	1	14
POTV's	6	6	1	1	14
COTV's	-	3	1		4
Cargo Handling	<u>9</u>	<u>2</u>	<u>2</u>	<u>2</u>	<u>15</u>
	<u>19</u>	<u>22</u>	<u>14</u>	<u>5</u>	<u>60</u>
Total for Concepts C&D	511	568	405	176	1660

Initial Estimate 1565

Δ + 95

Table 4-71. LRU In-Space Personnel Requirements.

<u>LRU CONCEPT</u>	<u>LEO</u>	<u>GEO</u>	<u>SMF</u>	<u>LUNAR BASE</u>	<u>TOTAL</u>
B					
Initial Assumption	0	36	1365	48	1449
Facility Sizing	0	36	1365	48	1449
Task Estimate	60	60	1400	60	1580
C&D					
Initial Assumption	0	(SMF)	200	1365	1565
Facility Sizing	0	(SMF)	1165	400	1565
Task Estimate	60	(SMF)	1200	400	1660

REFERENCES

1. Cowgill, Lane, "Low Acceleration Transfers from Low Earth Orbit to Low Lunar Orbit - Analysis for Lunar Resources Utilization Study," General Dynamics Convair Division Memo 697-0-78-070, Draft Copy, 9 August 1978.
2. Woodcock, G. R., et. al., "Future Space Transportation Systems Analysis Study." Contract NAS9-14323, Boeing Aerospace Company Report D180-20242-3, December 31, 1976.
3. Handbook of Lunar Materials, Lunar and Planetary Sciences Division, NASA-Lyndon B. Johnson Space Center, May 1978.
4. Howard, K., Heat, J., and Swan, G., "Geology of Hadley Rille, " Proc. Lunar Science Conference, 3rd, 1972, pp. 1-14.
5. Watkins, J., and Kovach, R., "Seismic Investigations of the Lunar Regolith," Proc. Lunar Science Conference, 4th, 1973, pp. 2561-2574.
6. Ulrich, G. E., "A Geologic Model for North Ray Crater and Stratigraphic Implications for the Dexartes Region," Proc. Lunar Science Conference, 4th, 1973, pp. 27-39.
7. Howard, K., Wilhelms, D., and Scott, D., "Lunar Basin Formation and Highland Stratigraphy," Rev. of Geophys. and Space Physics, Vol. 12, n. 3, 1974, pp. 309-327.
8. Anon.: Space Settlements - A Design Study, 1975 NASA Ames/OAST Summer Faculty Fellowship Program in Engineering System Design, NASA SP-413, NASA Science and Technical Information Office, 1977.
9. Heppenheimer, T. A., "Guidance and Trajectory Considerations in Lunar Mass Transportation," AIAA Journal, Vol. 15, No. 4, April 1977, pp. 518-525.
10. Carrier, W. D., "Lunar Strip Mining Analysis," Chapter III of "Extraterrestrial Materials Processing and Construction," Final Report on Contract NSR 09-051-001, Mod. No. 24, Lunar and Planetary Institute, Houston, Texas, 30 Sept. 1978.
11. Butler, J., Green, G., and King, E., "Grain Size Distribution and Modal Analyses of Apollo 16 Fines., "Proceedings of the 4th Lunar Sciences Conf., 1973, pp. 267-278.
12. Inculet, Ion I., "Beneficiation of Lunar Soils," Chapter IV of "Extraterrestrial Materials Processing and Construction," Final Report on Contract NSR 09-051-001, Mod. No. 24, Lunar and Planetary Institute, Houston, Texas, 30 Sept. 1978.
13. Waldron, R. D., Erstfeld, T. E., and Criswell, D. R., "Processing of Lunar and Asteroidal Material," Section III of "Extraterrestrial Materials Processing and Construction," Mid-Term Report on Contract NAS 09-051-001, 24 April 1978.

14. Langseth, M. D., and Heihm, S. J., "In Situ Measurements of Lunar Heat Flow," The Soviet-American Conference on Cosmochemistry of the Moon and Planets, June 4-8, 1974. NASA SP-370, Part I, 1977, pp. 283-293.
15. Mackenzie, J. D., "Glass and Ceramic Projects from Lunar Materials," Prepared under NASA Contract NAS 09-051-001, Extraterrestrial Materials Processing and Construction, June 1978.
16. Kesterke, D. G., "Electrowinning of Oxygen from Silicate Rocks," Bureau of Mines Report of Investigations RI 7587, 1971.
17. Henson, H. K., and Drexler, K.E., "Vapor-Phase Fabrication of Massive Structures in Space."
18. Drexler, K.E., and Henson, H. K., "Design of Equipment for Vapor-Phase Processing of Metals," Lunar Utilization, Abstracts of Paper presented at a Special Session of the Seventh Annual Lunar Science Conference, 16 March 1976.
19. Schiller, S., Foerstèr, H., and Jaesch, G., "Possibilities and Limitations of Large-Scale Electron-Beam Evaporation," J. Vac. Sci., Technol., Vol. 12, No. 4, July/August 1975, pp. 800-806.
20. Schiller, S., and Jaesch, G., "Deposition by Electron Beam Evaporation with Rates of up to 50 $\mu\text{m}/\text{sec}$," Paper presented at Third Conference on Metallurgical Coatings, San Francisco, 3-7 April, 1978.
21. Bunshah, R. F., "Structure/Property Relationships in Evaporated Thick Films and Bulk Coatings," J. Vac. Sci. Technol., Vol. 11, 1974, p. 633.
22. Phinney, W. C., Criswell, D., Drexler, E., and Garmirian, J., "Lunar Resources and Their Utilization."
23. Holmes, R.F., and Keller, E. E., "Bosch CO₂ Reduction System, Endurance Program - Final Report." Report No. CASD-NAS-77-026, October, 1977.
24. Movchan, B.A., Demchishin, A. V., and Kooluck, L. D., "Structure and Mechanical Properties of Thick Fe, Fe-NbC, Fe-N-NbC Condensates," E. O. Paton Welding Institute, Academy of Sciences, VKr., S. S. R., J. Vac. Soc. Technol., Vol. 11, No. 5, September/October 1974, pp. 869, 874.
25. Demidovich, Boris K., "Manufacture and Use of Foam Glass," Army Foreign Science and Technology Center, Charlottesville, Virginia, 25 October, 1974, Report No. AD/A-005819.
26. Oakeson, W. G., et. al., "Foam Glass Insulation from Waste Glass," University of Utah, EPA-600/3-77-030, August 1977.
27. Pittsburgh Corning Corporation Bulletin, Foamglas, Cellular Glass Insulation, May 1977.
28. Park, K.D., and Weitzman, E. J., "Glass Layer Evaporation," J. Vac. Sci. Technol., Vol. 14, No. 6, November/December 1977, pp. 1318-1319.

29. Mackenzie, J. D., "Glass and Ceramic Projects from Lunar Materials," Prepared under NASA Contract NAS 09-051-001, Extraterrestrial Materials Processing and Construction, June 1978.
30. Ho, Darwin, "Extraterrestrial Fiberglass Production Using Solar Energy," 1977 Summer Study, Space Settlements and Manufacturing, Sponsored by NASA Ames Research Center, Palo Alto, California.
31. Wolf, M., "Outlook for Si Photovoltaic Devices for Terrestrial Solar-Energy Utilization," J. Vac. Sci. Technol., Vol. 12, No. 5, September/October 1975, pp. 984-999.
32. Personal Communication, Morton B. Prince, D.O.E., Division of Solar Tech.
33. Wald, F. V., "EFG Silicon Ribbon-Status Report," Proceedings: 9th Project Integration Meeting, Low-Cost Solar Array Project, 11-12 April, 1978, Jet Propulsion Laboratory Report 5101-67, pp. 3-65 to 3-73.
34. Mineral Facts and Problems, Bureau of Mines Bulletin 667, 1975 Edition, p. 993.
35. Reference 33, Section III, Technology Development Area, Silicon Material Task, pp. 3-1, 3-2.
36. Reference 33, Section IV, Production Process and Equipment Area, Automated Array Assembly Task, pp. 4-1 and 4-59.
37. Phinney, W. C., Criswell, D., Drexler, E., and Garmirian, J., "Lunar Resources and Their Utilization," Lunar and Planetary Sciences Division, Johnson Space Flight Center.
38. Arnold, J. R., "Ice in the Lunar Polar Regions," University of California, San Diego.
39. Heald, D. A., et al, "Orbital Propellant Handling and Storage Systems for Large Space Programs," Final Report No. CASD-ASP-78-001 (JSC 13967), General Dynamics Convair Division, San Diego, California, 14 April 1978.
40. Anon.: "Space Station Definition," Final Report, McDonnell Douglas Astronautics Co., July 1970, (Contract NAS8-25140).
41. Anon.: "Solar Powered Space Station," Final Report, North American Rockwell Space Division, Report No. SD70-159-1 (MSC-00720), July 1970 (Contract NAS9-9953).
42. Anon.: "Modular Space Station," Final Report, McDonnell Douglas Astronautics Co., Nov 1971, (Contract NAS8-25140).
43. Anon.: "Modular Space Station," Final Report, North American Rockwell Space Division, Report No. SD71-217-1 (MSC-02471), January, 1972 (Contract NAS9-9953).
44. Anon.: Space Station Systems Analysis, Final Report, Grumman Aerospace Corp., 27 July 1977 (Contract NAS8-31993).

45. Anon.: Space Station Systems Analysis Study, Final Report, McDonnell Douglas Astronautics Co., 1977 (Contract NAS9-14958).
46. Anon.: Lunar Base Synthesis Study Final Report, North American Rockwell, Report No. SD71-477-1, 15 May 1971 (Contract NAS8-26145).
47. Anon.: Design of a Lunar Colony, 1972 NASA/ASEE Systems Design Institute, Sept. 1972 (NASA CR-129164).
48. Vjak, J. Peter, et al: Habitat and Logistic Support Requirements for the Initiation of a Space Manufacturing Enterprise, 1977 NASA-Ames/OAST Summer Study on Space Settlements and Industrialization.
49. Chriswell, David R., Initial Lunar Supply Base: Resources and Construction, 1977 NASA Ames/OAST Summer Study on Space Settlements and Industrialization.
50. Anon.: Space Settlements - A Design Study, 1975 NASA Ames/OAST Summer Faculty Fellowship Program in Engineering System Design, NASA SP-413 NASA Science & Technical Information Office, 1977.
51. Driggers, G., & Newmar, J.: Establishment of a Space Manufacturing Facility, 1976 NASA Ames/OAST Study on Space Manufacturing from Non-Terrestrial Materials, November 25, 1976.
52. Bock, Edward H., Effect of Environmental Parameters on Habitat Structural Weight and Cost, 1977 NASA Ames/OAST Summer Study on Space Settlements and Industrialization.
53. Haffner, J. W., Radiation and Shielding In Space, Academic Press, N. Y., 1976.
54. French, F. W., "Solar Flare Radiation Protection Requirements for Passive and Active Shields," Journal of Spacecraft and Rockets, Vol. 7, No. 7, pgs. 794-800.
55. "A Recommended Preliminary Baseline Concept," NASA-JSC Satellite Power System (SPS) Concept Evaluation Program Presentation Brochure, Dated January 25, 1978.
56. "Solar Power Satellite Concept Evaluation," Activities Report July 1976 to June 1977, Volume 2 Detailed Report, July 1977 (NASA JSC Red Book).
57. "Electric Propulsion System for Lunar Resource Utilization for Space Construction," Letter to E. H. Bock from John D. Regetz, Jr., NASA-Lewis Research Center, Dated June 27, 1978.
58. Kolm, H., O'Neill, G. K., et. al., "Electromagnetic Mass Drivers," 1976 NASA Ames/OAST Study, Space Manufacturing from Nonterrestrial Materials Volume for Progress in Aeronautics and Astronautics Series, Preprint Dated November 25, 1976.

59. Kolm, H., O'Neill, G. K., et. al., "Mass Driver Applications," 1976 NASA Ames/OAST Study, Same Source as Reference 58.
60. Heppenheimer, T. A., "The Lunar Mass Transport Problem in Space Colonization," Paper Reprint, AAS/AIAA Astrodynamics Specialist Conference, Jackson Hole, WY, Sept 7-9, 1977.
61. Heppenheimer, T. A., "Steps Toward Space Colonization: Colony Location and Transfer Trajectories," Journal of Spacecraft and Rockets, Vol 15. No. 5, Sept/Oct 1978, Page 305.

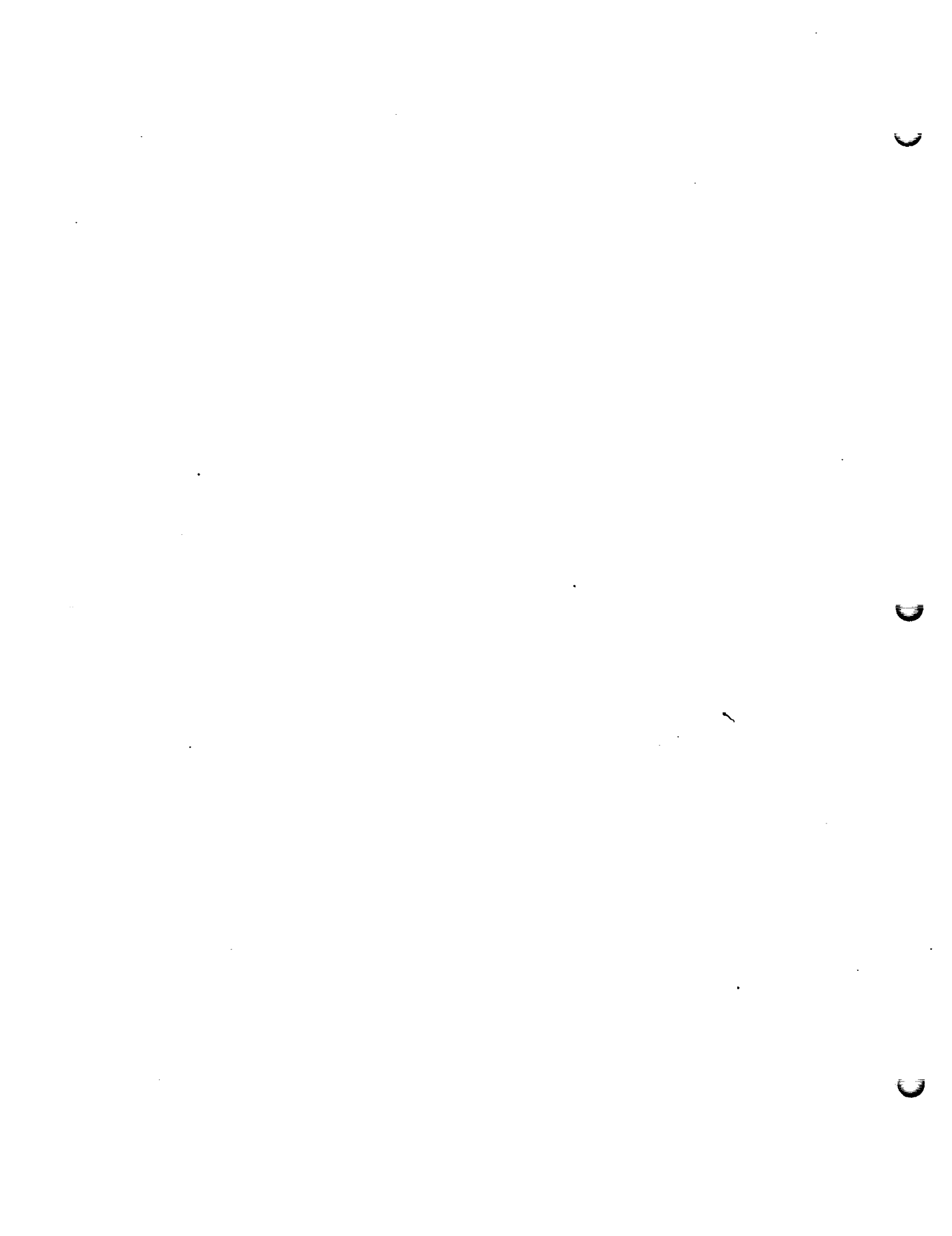

5

ECONOMIC ANALYSES (TASKS 5.3, 5.4 & 5.6)

Aside from considerations dealing with technical feasibility, cost is probably the most important measure in determining the desirability of a scenario. Assuming that one scenario, whether earth, space or lunar based, is equal to the next in meeting program specifications, the question becomes one of determining which scenario is the most cost effective. The purpose of the economic analysis tasks in this study was to do just that. Not only were costs for each alternative program determined, but the uncertainty attached to those costs was determined as well. Two other factors useful in making economic comparisons: time phased funding spreads and present value of costs were also determined. The economic analysis portion of the study was divided into three major task areas: Cost Analysis, Uncertainty Analysis, and Funding Spread/Present Value Analysis. These are briefly described in the following paragraph and in more detail in Sections 5.1 through 5.5. Figure 5-0 shows the contents of each major task area and the general order of task performance.

COST ANALYSIS —

The documentation of the cost tasks is contained in Sections 5.1 through 5.3. The purpose of the cost analysis is to compare the program costs of each LRU concept with the Earth Baseline costs provided by NASA/JSC in a baseline concept brochure dated 25 January 1978. In order to provide consistent comparisons a WBS was developed that was compatible with all concepts. The Earth Baseline costs were categorized into this WBS for comparison with the LRU concepts.

The approach to total program cost determination for the LRU concepts was to first develop the costs of the primary elements (i. e. , processing and manufacturing, transportation and infrastructures) and then assemble them into the WBS for comparison with the baseline. Comparisons were then made and differences in production

costs were reconciled in order to explain major cost differences and to identify areas of uncertainty or omission. Finally, a determination was made of the nominal thresholds where lunar resource utilization becomes more cost effective. Subsequent study tasks, including the discount analysis and cost uncertainty analysis, used the nominal costs determined in this task as a base.

UNCERTAINTY ANALYSIS —

The uncertainty analysis complements and expands the cost analysis in Sections 5.1, 5.2 and 5.3. The discussion of this analysis is contained in Section 5.4. The nominal costs in Sections 5.1 and 5.3 represent point cost estimates which are based on historical data, direct quotes, analyst judgment and extrapolations of previous cost estimates. There is a great deal of uncertainty associated with these point cost estimates in the areas of supply/demand shifts, unknowns in the space/lunar based manufacturing chain and the state of definition of the hardware and program characteristics. The uncertainty analysis is an attempt to quantify that uncertainty. It provides a measure of confidence in our ability to accurately compare future conceptual projects and significantly affects the economic threshold point where the LRU concepts become cost effective.

FUNDING SPREAD/PRESENT VALUE —

The funding spread and present value analyses shed a slightly different light on program cost comparisons. Nominal cost estimates consider the magnitude of cost but not the timing of the required expenditures. A funding spread analysis allows timing to be considered. The present value analysis allows consideration of both the timing of cash flows and the time value of money. The results of these analyses are presented in Section 5.5.

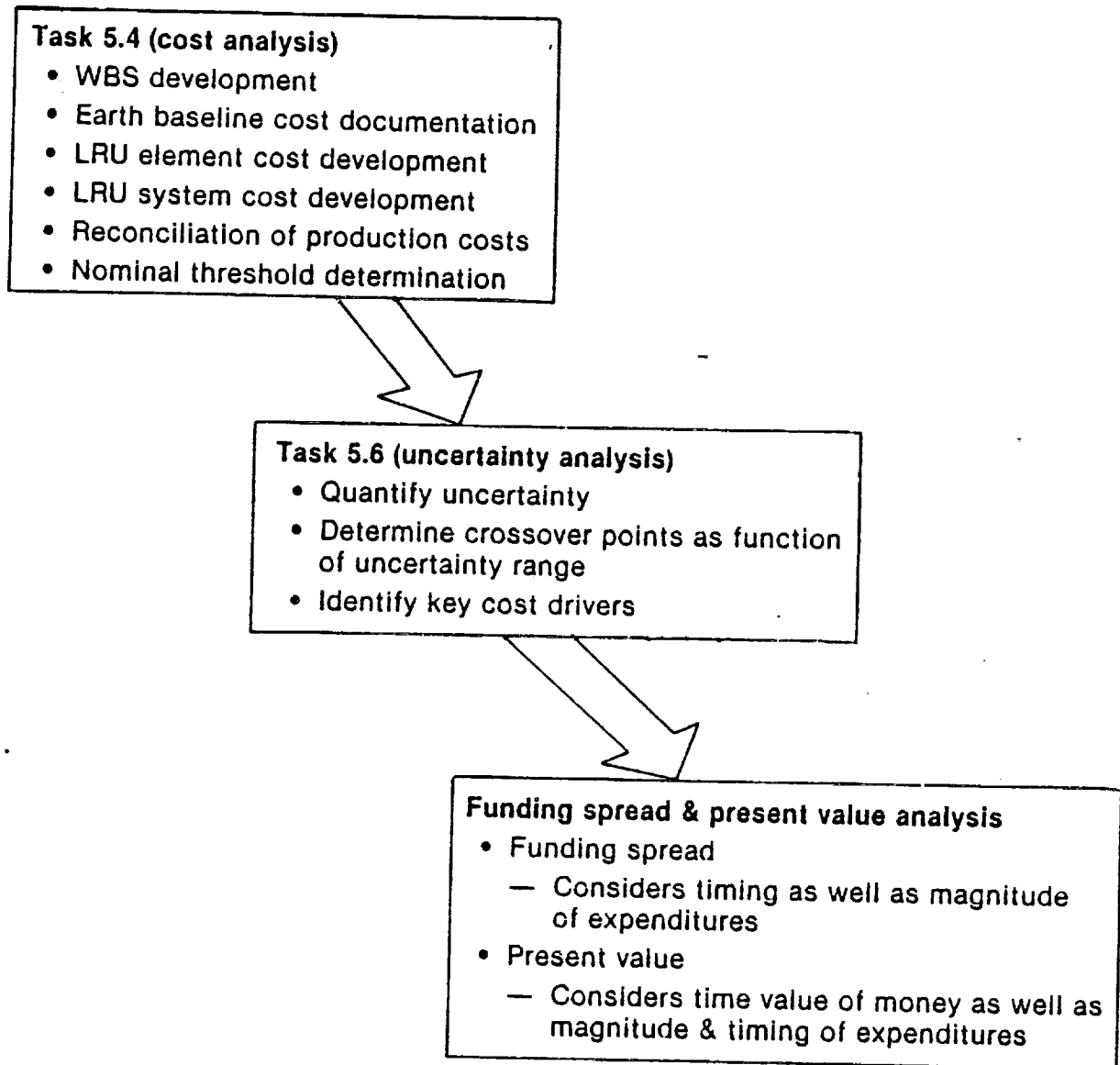

Figure 5-0. Economic Analysis Task Flow.

5.1 EARTH MANUFACTURED SPS BASELINE

Lunar Resources Utilization scenarios were compared with the earth manufactured SPS baseline identified by JSC in "A Recommended Preliminary Baseline Concept", a briefing dated January 25, 1978. Costs identified in the baseline document were utilized to provide the desired program cost information, either directly or through manipulation. An additional source of cost information was the JSC document, Satellite Power System (SPS) Concept Evaluation Program, dated July 1977.

In order to use the baseline cost data effectively the Cost Work Breakdown Structure (WBS) was organized such that it is compatible with the lunar resource utilization options costs. In this section a cost WBS is developed and earth baseline costs are organized under its elements.

5.1.1 Cost Work Breakdown Structure

The establishment of a flexible and comprehensive cost work breakdown structure (WBS) is important in assuring that valid cost comparisons are made in the comparative evaluation process. The cost WBS must assure that costs for each manufacturing scenario are organized under the appropriate cost elements and that like costs are compared with one another.

A cost WBS was developed and is shown in Figure 5-1. More detailed breakdowns with element numbers are shown by program phase in Figures 5-2, 5-3 and 5-4. This WBS provides the organization necessary for determining the life cycle cost of each scenario as well as breaking out costs by program phase or subelement. Once costs are established for each element, figure of merit data can be derived from the appropriate subelements.

The WBS organization is basically derived from the categories in the SPS baseline briefing document. Some allowance was also made for additional categories not in the baseline which arise under the lunar scenarios or during the program life. Elements are defined in Tables 5-1, 5-2 and 5-3.

5.1.2 SPS Baseline Life Cycle Cost

A determination was made of the baseline SPS system life cycle costs. This data is presented in Table 5-4. All supporting data for determining costs is contained in accompanying footnotes and in the figures in Appendix F.

Costs were broken down into three major program phases of the SPS system life, according to the WBS developed in the previous section. The primary source for these costs was the SPS Baseline document mentioned in Section 5.1.

Life Cycle Cost in this case is for the 30 year period from program inception to construction completion of the thirtieth SPS system. Since the operational phase duration has not been defined, the operations phase cost estimate may result in an understated life cycle cost, because the program life will probably be much longer than 30 years. For the 30 year program the SPS baseline life cycle cost was found to be \$913.713 billion.

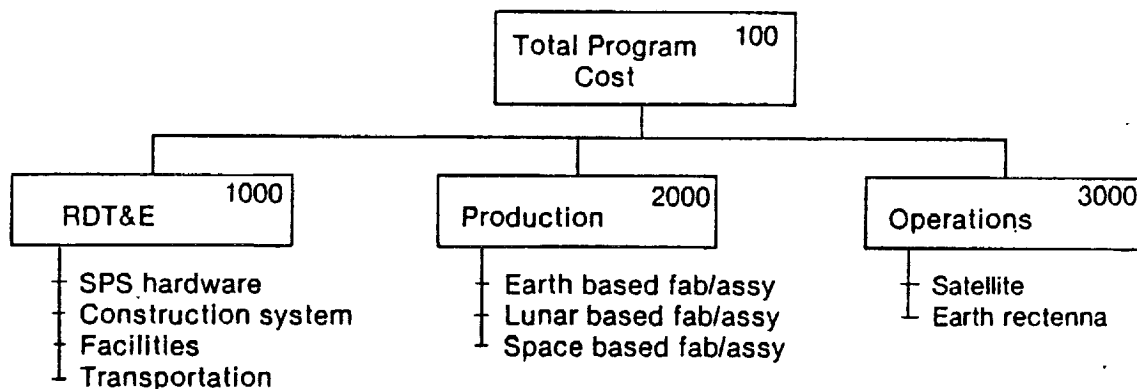

Figure 5-1. Summary Cost Work Breakdown Structure.

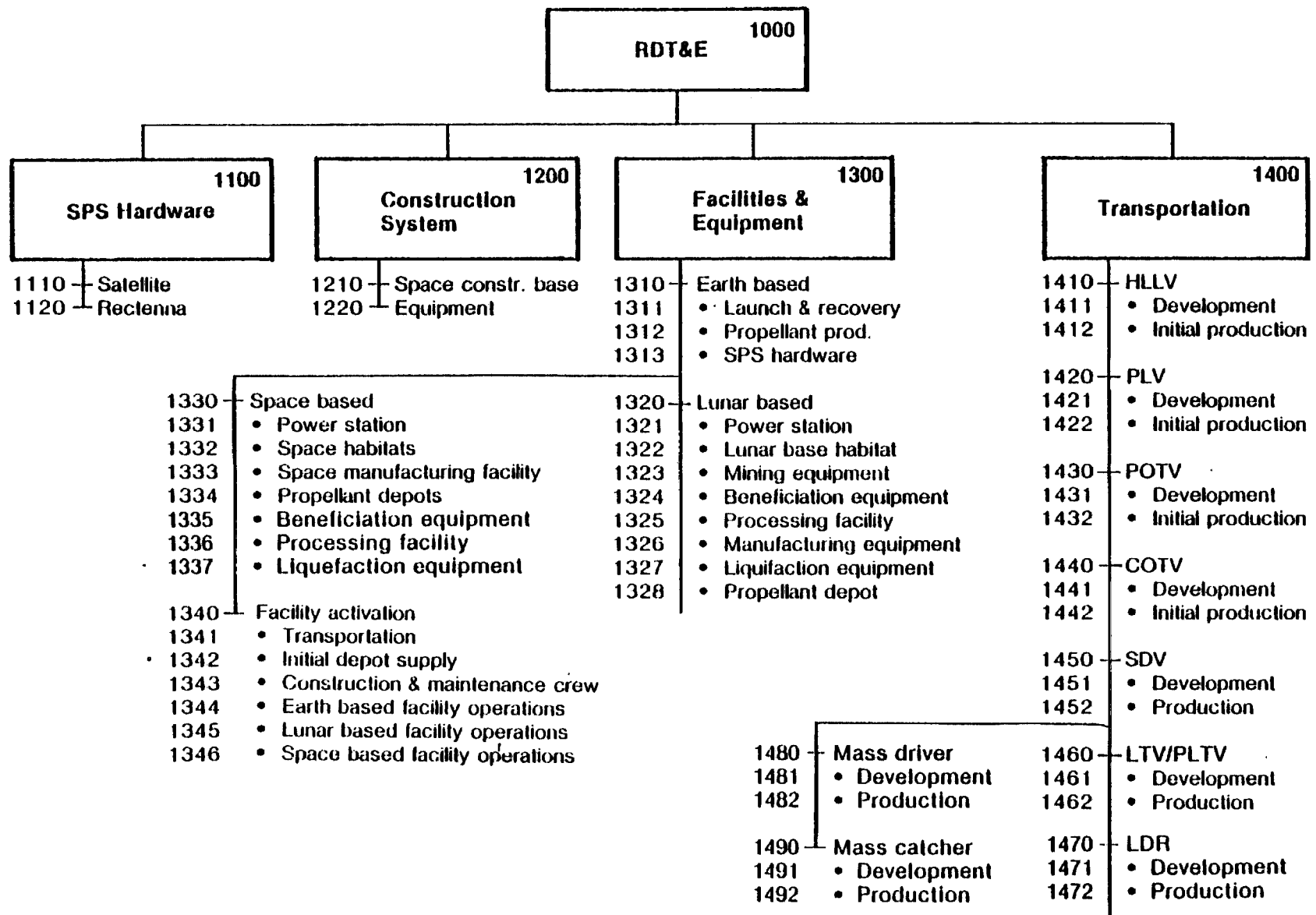

Figure 5-2. Development Cost Work Breakdown Structure.

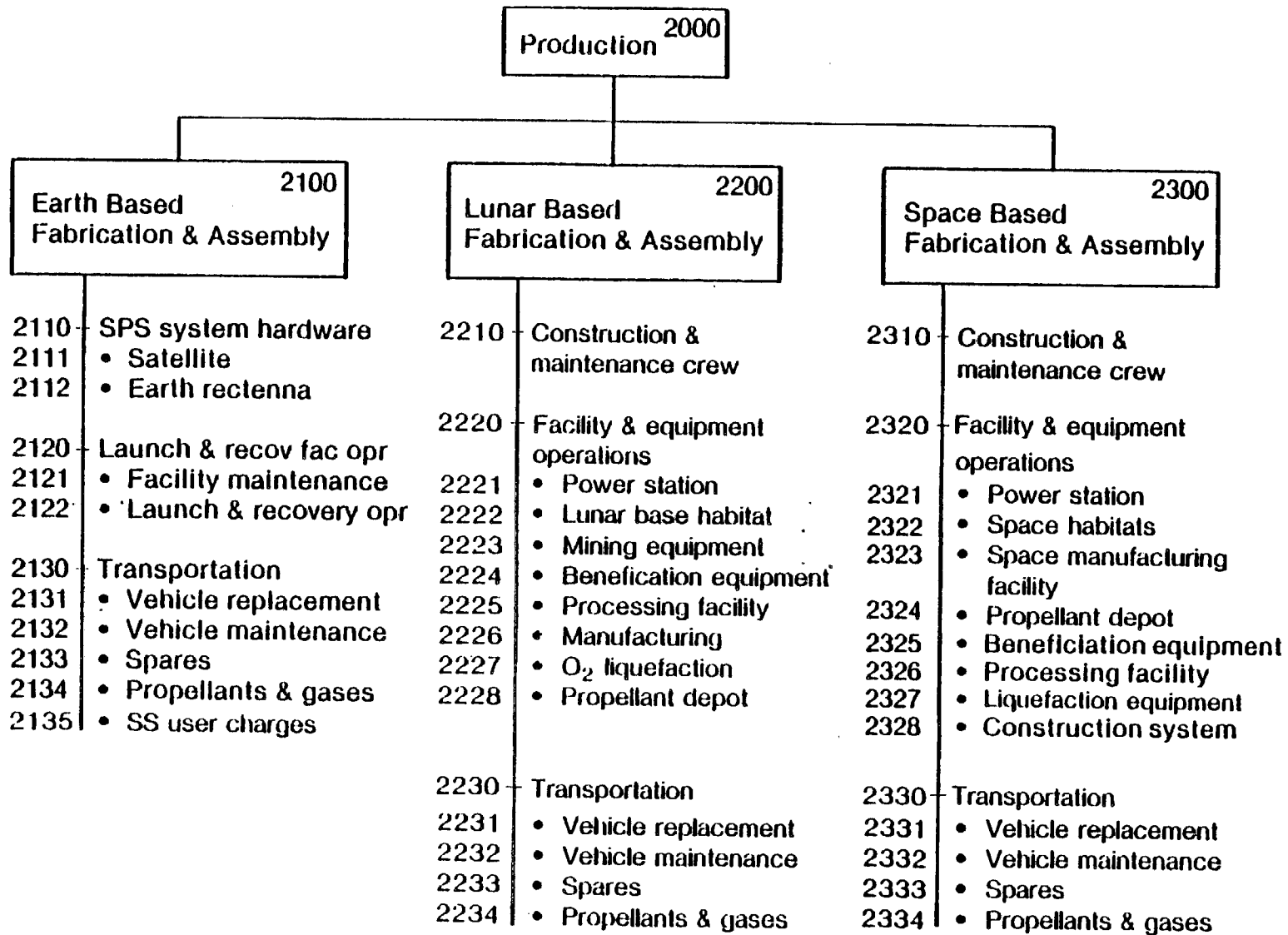

Figure 5-3. Production Cost Work Breakdown Structure.

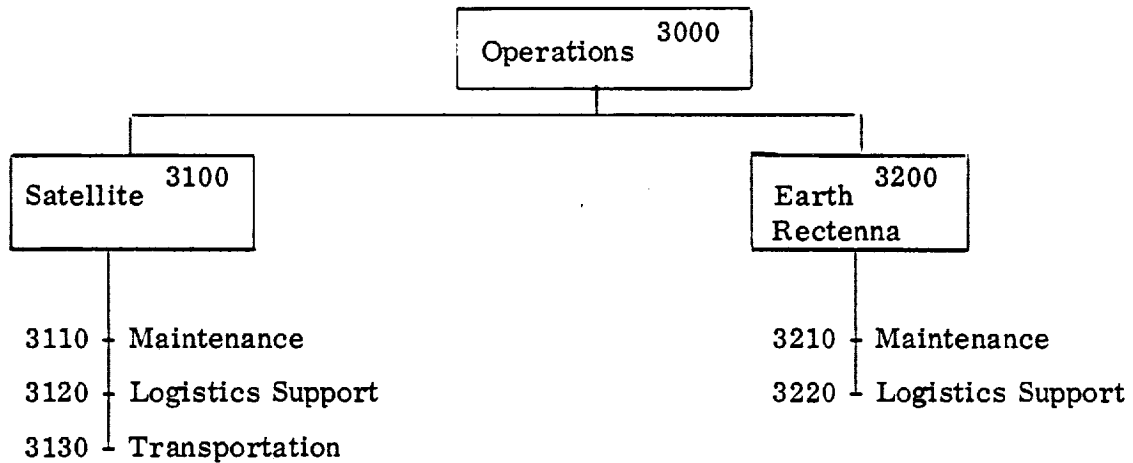

Figure 5-4. Operations Cost Work Breakdown Structure

5.2 LUNAR RESOURCE UTILIZATION ELEMENT COSTS

In order to determine the points at which lunar resources utilization (LRU) becomes cost effective the life cycle cost (LCC) of each of the three LRU options (Reference Options B, C and D) must be compared with the Earth manufactured baseline costs of Section 5.1. The purpose of this section is to develop the cost data necessary for determining the LCC of each of the three options. The data and scaling relationships developed can readily be used as a data source when LCC is determined in Section 5.3 and provide a basis for cost estimates in the future if facility/transportation element sizes change.

Due to the similarity of the LRU elements to the elements of previous NASA space studies, most of the LRU element costs can be derived or scaled from those studies. Existing cost estimates for space stations, space construction bases, orbital transfer and launch vehicles can be readily applied to obtain cost relations for propellant depots, habitats, facilities, vehicles and other LRU elements. The industry studies used as a basis for the LRU element cost relations will be referenced in the discussion of each individual element. Some LRU elements exhibit conceptual and innovative characteristics which are not similar to previously studied space systems. For these elements

Table 5-1. RDT&E Phase Definitions

Cost Element Number	Cost Element Designation	Definition
1000	RDT&E Phase	Includes the cost to develop elements necessary to put the first-system SPS in operational use. Includes the development of the satellite and rectenna, the development and production of construction equipment, manufacturing facilities and transportation. Conceptual and program definition studies are excluded.
1100	SPS Hardware	This is the cost to design and develop SPS system hardware: Satellite and rectenna systems.
1200	Construction System	Cost to design and fabricate the space construction system. The construction system includes all elements necessary to provide a space construction capability. It <u>excludes</u> all material processing type facilities and is limited to facilities and equipment necessary to construct/assemble elements in orbit. It includes such items as habitats, cranes and beam builders and the transportation for fabricating/constructing the construction system.
1300	Facilities and Equipment	This element refers to the cost to design and build the facilities to support the SPS program. It is broken down into three major categories, depending on location: Earth Based, Lunar Based and Space Based. Earth Based facilities are those facilities required for vehicle launch/recovery and propellant and hardware production. Lunar and Space Based facilities include, (1) the facilities required for the manufacture of SPS elements, (2) facilities which support the manufacture, such as habitats, (3) equipment required to support manufacturing such as power supply systems and lunar surface logistics vehicles (4) launch facilities, (5) and propellant production facilities.
1400	Transportation	This element includes the cost to design, develop and produce the initial fleet of transportation vehicles required for the SPS program. Includes vehicles identified in the JSC SPS baseline as well as other lunar and lunar/space scenarios. Included are: HLLV, PLV, POTV, COTV, OTV passenger module, mass driver and mass catcher, terminal tug and lunar transfer vehicle.

Table 5-2. Production Phase Definitions

Cost Element Number	Cost Element Designation	Definition
2000	Production Phase	All material and activities necessary to fabricate and assemble the SPS fleet are included in this phase. It includes facility and construction system operations, hardware, and transportation vehicle replacement costs over the production period. Provisions are made for fabrication and assembly on earth, moon, space or a combination of these locations.
2100	Earth based Fabrication and Assembly	Includes all production activities required to manufacture and fabricate SPS system hardware on earth and the costs to replace and maintain vehicles as the initial fleet wears out. Also includes the operations of the ground facilities required for producing the SPS fleet. This includes (1) the costs incurred in operating earth launch facilities and providing launch, tracking, command and control, recovery and maintenance of vehicles and of the launch/recovery facilities, (2) the cost of propellants and gases for the launch vehicles and (3) the cost of SPS system hardware. The cost of maintaining and operating the propellant production and hardware manufacturing facilities is included in the cost of propellants and hardware.
2200	Lunar based Fabrication and Assembly	This element includes all production activities required to fabricate SPS systems at a lunar base. Includes hardware, operation of the manufacturing facilities to fabricate stock materials, and hardware, logistics support of habitats, and operation of the launch facilities to transfer men and material to the construction orbit.
2300	Space Based Fabrication and Assembly	This element includes all production activities required to manufacture, fabricate, assemble and construct the SPS systems in orbit. For space based manufacturing the category includes cost of stock materials and hardware manufactured. This element also includes the cost to maintain the space construction system, which includes habitats and the equipment necessary for on-orbit assembly.

Table 5-3. Operations Phase

Cost Element Number	Cost Element Designation	Definition
3000	Operations Phase	Cost of operating the SPS system, including the satellite and rectenna.
3100	Satellite	Includes the cost of maintaining the satellite in operating condition. Maintenance crew labor, spares and transportation costs required are included.
3200	Earth Rectenna	This element refers to the cost of maintaining the earth based rectenna system in operating condition and includes maintenance, repair and spares.

Table 5-4. Earth Baseline Life Cycle Cost

Cost Element Number	Designation	Cost (Billions of 77 \$)	Volume III Appendix F References
1000	RDT&E Phase		70.586
1100	SPS Hardware		6.270 Fig. F-1
1200	Construction System		20.741
1210	Space Construction Base	20.741	
1211	Development	6.939	Fig. F-1
1212	Fabrication	13.802	Fig. F-2
1300	Facilities & Equipment		16.666
1310	Earth Based	16.666	
1311	Launch/Recovery	2.8	Fig. F-3
1312	Propellant Production	3.5	Fig. F-3
1313	SPS Hardware	10.366	Fig. F-1
1400	Transportation		26.909
1410	HLLV		17.826 Note 1
1411	Development	11.100	
1412	Initial Fleet Production	6.726	
1420	PLV		3.314
1421	Development	2.400	Fig. F-3
1422	Initial Fleet Production	.914	Note 2,
1430	POTV		2.369 includes ET's
1431	Development	2.000	
1432	Initial Fleet Production	.369	Note 3
1440	COTV		3.400 Note 4
1441	Development	1.700	
1442	Initial Fleet Production	1.700	
2000	Production Phase		656.476
2100	Earth Based Fabrication & Assembly		619.996
2110	SPS System Hardware	401.391	

5-12

Table 5-4. Earth Baseline Life Cycle Cost (continued)

Cost Element Number	Designation	Cost (Billions of 77 \$)		Volume III Appendix F References
2111	Satellite	268.011		Note 5
2112	Earth Rectenna	133.38		Note 6
2120	Launch/Recovery Facility Operations		4.200	
2121	Facility Maintenance	4.200		
2122	Launch & Recovery Operations	0		
2130	Transportation		214.405	
2131	Vehicle Replacement	70.945		Note 8
2132	Vehicle Maintenance	118.257		Note 8
2133	Spares	0		Note 8
2134	Propellants/Gases	25.203		Note 8
2200	Lunar Based Fabrication & Assembly		0	
2300	Space Based Fabrication & Assembly		36.480	
2320	Construction System Operations		36.480	Note 9
3000	Operations Phase		186.651	
3100	Satellite		124.629	Note 10
3200	Earth Rectenna		62.022	Note 10
100	TOTAL PROGRAM COST		913.713	

NOTE: 1. Referenced notes and figures are contained in Appendix F.

(e.g., mass driver) costs will be based on: (1) specialist estimates, (2) direct analogies to similar industrial products or services, and (3) cost estimating relationships.

The end result of this portion of the study task was a cost handbook for the LRU study. It provides a means of costing the major elements of any lunar resource option as a function of their size. Due to the length of the cost derivations they were inserted in Appendix G. A summary of cost elements contained in that appendix is as follows:

Propellant Depot

Habitats

LEO Modular Space Station	Lunar Based Habitat (Small Crew)
GEO Modular Space Station	Large Lunar Base (Shuttle Tanks)
Temporary Shelter	Space Manufacturing Facility

Transportation

Heavy Lift Launch Vehicle	LRU Personnel Orbital Transfer Vehicle
Personnel Launch Vehicle	LRU Cargo Orbital Transfer Vehicle
Personnel Orbital Transfer Vehicle	Lunar Transfer Vehicle
Cargo Orbital Transfer Vehicle	Personnel Lunar Transfer Vehicle
Passenger/Crew Modules	Lunar Derived Rocket
Shuttle Derived Vehicle	Mass Catcher
Space Shuttle	Mass Driver Catapult

Earth Based Facilities

- Propellant Production
- Launch/Recovery

LRU Manufacturing Facilities and Equipment

Lunar Mining Equipment	Liquefaction Equipment
Lunar Material Beneficiation Equipment	Manufacturing Facilities
Processing Facility	

Power Stations

- Photovoltaic Power
- Nuclear Power

5.3 TOTAL PROGRAM COST OF THE LRU OPTIONS

5.3.1 COSTS. The economics of using lunar resources as an alternative to earth resources is dependent upon the ability to achieve the same end product at a lower cost. Cost effectiveness analyses must be performed to determine if the lunar resources alternative is a desirable one. This not only includes consideration of total program costs in undiscounted constant dollars but also using discounted dollars and cost uncertainty factors.

Before performing any sort of economic analysis, a cost base must be established for each LRU option, on which comparisons with the Earth Baseline may be made. It is the purpose of this section to provide that cost base. Costs for each LRU option are categorized into the same Work Breakdown Structure (WBS) as the Earth Baseline, giving Development, Production, Operations and Total Program Cost. The Cost WBS was previously discussed in Section 5.1.1 and is summarized in Figures 5-1 through 5-4. Definitions of the cost elements were provided in Tables 5-1 through 5-3.

Program Costs for each LRU option are provided in Tables 5-5 , 5-6 and 5-7 . Notes to the tables, which provide a detailed explanation of cost derivation, are contained in Appendix H. The costs shown are based on the LRU element costs in Section 5.2 and on the following ground rules/assumptions:

1. Costs are expressed in constant year 1977 dollars. Current prices are assumed. No attempt was made to adjust costs for changes in future supply and demand.
2. Satellites will be produced at a rate of 1 per year for 30 years. Operations Costs are limited to the 30-year period, starting with the operation of one satellite in the first year and ending with the operation of 30 satellites in the 30th year.
3. The following costs are the same for the Earth Baseline and LRU Concepts:
SPS Hardware Development (Satellite & Rectenna)
Earth Rectenna Production
Development/Fabrication of Orbiting Construction Systems

4. No new earth based SPS Hardware Manufacturing Facilities are required for the LRU concepts. The following earth supplied production items were assumed to be purchased from existing earth suppliers:
 - Earth Rectennas
 - Any satellite equipment which cannot be fabricated in space or material not available from the lunar soil
5. Earth based support facilities such as mission control, administration and sustaining engineering were assumed to be existing and no charges were included for these facilities in either the Earth Baseline or the LRU Concepts. The recurring cost of manning and operating these facilities in support of the lunar/space based manufacturing is assumed to be 3% per year of the cost to fabricate the manufacturing facilities.
6. The requirements for lunar and space based launch facilities are assumed minimal and no costs were included for their development or construction.
7. Lunar resources are not used to fabricate the lunar and space based facilities. They are fabricated on earth, then transported to final location and assembled during the facility activation phase.
8. The lunar and space based facilities in all LRU Concepts are owned and operated by a single entity who is in business for the purpose of selling power for profit. This entity uses the facilities to manufacture and construct the SPS fleet and purchases from earth only those materials not available from the lunar soil. The Earth Baseline costs are based on the normal way of doing business on earth today in that the entity purchases, rather than manufactures, the majority of SPS hardware from independently owned, earth based firms.

Table 5-8 provides a summary comparison of alternative program costs. On a nominal basis, without regard to uncertainty or other economic factors, the LRU concepts appear to be more cost effective than the Earth Baseline. On a total program cost basis Concept B is 66% of the Earth Baseline costs with Concepts C and D

following at 72% and 71% respectively. The differences in RDT&E costs were expected due to the larger amount of facilities and transportation elements in the LRU alternatives. The large differences in the Production Phase were somewhat surprising, and, as a result a new task was added to reconcile those differences. The results of the reconciliation will be discussed in Section 5.3.3.

Table 5-5 . LRU Option B Life Cycle Cost.

Volume III
Appendix II
Reference

Cost Element Number	Designation	Cost (Billions of 77 \$)				Volume III Appendix II Reference
1000	RDT&E Phase				121.756	
1100	SPS Hardware			6.270		Earth Baseline
1200	Construction System			20.741		Earth Baseline
1300	Facilities & Equipment			68.775		
1310	Earth Based			1.338		Sect G.4
1311	Launch/Recovery		.453			
1312	Propellant Production		.885			
1320	Lunar Based			5.388		
1321	Power Station		2.076			Note 1.1
1322	Lunar Base Habitat		3.202			Note 1.2
1323	Mining Equipment		.050			Sect G.5.1
1324	Beneficiation Equipment		.015			Note 1.3
1326	Manufacturing Equipment		.037			Table G-41
1328	Propellant Depot		.008			Note 1.4
1330	Space Based			52.756		
1331	Power Station		2.341			Note 2.1
1332	Space Habitats		38.528			
-1	LEO	7.793				Note 2.2
-2	GEO	5.397				Note 2.3
-3	LLO	.199				Note 2.4
-4	SMF	25.139				Note 2.5
1333	Space Manufacturing		7.450			Table G-41
1334	Propellant Depots		.521			Table G-4
1335	Beneficiation Equipment		.019			Note 2.6
1336	Processing Facility		3.650			Note 2.7
1337	Liquifaction Equipment		.247			Note 2.8

Table 5-5 . LRU Option B Life Cycle Cost (Continued).

Cost Element Number	Designation	Cost (Billions of 77 \$)			Volume III Appendix H Reference
1340	Facility Activation		9.293		
1341	Transportation	7.305			Note 3.1
1342	Initial Depot Supply	.002			Note 3.2
1343	Construction/Maintenance Crew	.288			Note 3.3
1344	Earth Based Facility Operations	.068			Note 3.4
1345	Lunar Based Facility Operations	.118			Note 3.5
1346	Space Based Facility Operations	1.512			Note 3.6
1400	Transportation			25.970	
1430	POTV		1.667		Note 4.1
1431	Development	1.191			
1432	Initial Production	.476			
1440	COTV		9.342		Note 4.2
1441	Development	.637			
1442	Initial Production	8.705			
1450	SDV		11.090		Note 4.3
1451	Development	6.832			
1452	Initial Production	4.258			
1460	PLTV		.443		Section G.3.11
1461	Development	.369			
1462	Initial Production	.074			
1480	Mass Driver		1.500		Section G.3.14
1481	Development	1.150			
1482	Initial Production	.350			
1490	Mass Catcher		1.928		Note 4.4

Table 5- 5. LRU Option B Life Cycle Cost (Continued).

Cost Element Number	Designation	Cost (Billions of 77 \$)				Volume III Appendix H Reference
1491	Development		.678			
1492	Initial Production		1.250			
2000	Production Phase				298.325	
2100	Earth Based Fabrication & Assembly				229.462	
2110	SPS System Hardware			176.517		
2111	Satellite		43.137			Note 5.1
2112	Earth Rectenna		133.380			Note 5.2
2120	Launch/Recovery Facility Ops			.680		Note 5.3
2121	Facility Maintenance		.680			
2130	Transportation (SDV/SS)			52.265		Note 6.1
2131	Vehicle Replacement		8.342			Note 6.1
2132	Vehicle Maintenance		17.485			Note 6.2
2133	Spares		—			Note 6.2
2134	Propellants/Gases		1.838			Note 6.3
2135	Shuttle User Charge		24.600			Note 6.4
2200	Lunar Based Fabrication & Assy				2.944	
2210	Construction/Maint Crew			.173		Note 7.1
2220	Facility/Equipment Operations			2.366		
2221	Power Station		1.035			Note 8.1
2222	Lunar Based Habitat		1.247			Note 8.2
2223	Mining Equipment		.060			Section G.5.1
2224	Beneficiation Equipment		.006			Note 8.3
2226	Manufacturing Equipment		.018			Note 8.4
2230	Transportation (PLTV/MD)			.405		Note 9.1
2231	Vehicle Replacement		—			Note 9.1
2232	Vehicle Maintenance		.303			Note 9.2

5-20

Table 5-5 . LRU Option B Life Cycle Cost (Continued).

Cost Element Number	Designation	Cost				Volume III Appendix H Reference
		(Billions of 77 \$)				
2233	Spares		.101			Note 9.3
2234	Propellants/Gases		.001			Note 9.4
2300	Space Based Fabrication & Assy				65.919	
2310	Construction/Maintenance Crew			5.044		Note 10.1
2320	Facility/Equipment Operations			48.152		
2321	Power Station		2.074			Note 11.1
2322	Space Habitats		20.856			Note 11.2
2323	Space Manufacturing Facility		3.624			Note 11.3
2324	Propellant Depot		.625			Note 11.4
2325	Beneficiation Equipment		.010			Note 11.5
2326	Processing Facility		2.912			Note 11.6
2327	Liquifaction Equipment		.141			Note 11.7
2328	Construction System		17.910			Note 11.8
2330	Transportation (COTV/POTV/MC)			12.723		Note 12.1
2331	Vehicle Replacement		.316			Note 12.1
2332	Vehicle Maintenance		9.242			Note 12.2
2333	Spares		3.076			Note 12.2
2334	Propellants/Gases		.089			Note 12.2
3000	Operations Phase				186.651	Earth Baseline
3100	Satellite				124.629	
3200	Earth Rectenna				62.022	
100	Total Program Cost				606.732	

5-21

NOTE: Referenced notes are contained in Appendix II.

Table 5- 6. LRU Option C Life Cycle Cost

Cost Element Number	Designation	Cost (Billions of 77 \$)	Volume III Appendix H Reference
1000	RDT&E Phase	135.476	
1100	SPS Hardware	6.270	Earth Baseline
1200	Construction System	20.741	Earth Baseline
1300	Facilities & Equipment	75.911	
1310	Earth Based	1.748	Sect G. 4
1311	Launch/Recovery	.664	
1312	Propellant Production	1.084	
1320	Lunar Based	19.525	
1321	Power Station	7.617	Note 1.1
1322	Lunar Base Habitat	6.756	Note 1.2
1323	Mining Equipment	.050	Sect G. 5.1
1324	Beneficiation Equipment	.023	Note 1.3
1325	Processing Facility	4.201	Sect G. 5.3
1326	Manufacturing Equipment	.292	Sect G. 5.5
1327	Liquefaction Equipment	.558	Note 1.4
1328	Propellant Depot	.028	Sect G.1
1330	Space Based	41.248	
1331	Power Station	1.323	Note 2.1
1332	Space Habitats	32.058	
-1	LEO	7.793	Note 2.2
-2	GEO	23.003	Note 2.3
-3	LLO	1.262	Note 2.4
1333	Space Manufacturing	7.158	
1334	Propellant Depots	.709	Sect G.1

5-22

Table 5-6 . LRU Option C Life Cycle Cost (continued)

Cost Element Number	Designation	Cost (Billions of 77 \$)	Volume III Appendix H Reference
1340	Facility Activation	13.390	
1341	Transportation	11.072	Note 3.1
1342	Initial Prop Depot Supply	.009	Note 3.2
1343	Construction/Maintenance Crew	.288	Note 3.3
1344	Earth Based Facility Operations	.100	Note 3.4
1345	Lunar Based Facility Operations	.789	Note 3.5
1346	Space Based Facility Operations	1.132	Note 3.6
1400	Transportation	32.554	
1430	POTV	1.661	Note 4.1
1431	Development	1.191	
1432	Initial Production	.470	
1440	COTV	16.318	Note 4.2
1441	Development	.691	
1442	Initial Production	15.627	
1450	SDV	13.706	Note 4.3
1451	Development	6.832	
1452	Initial Production	6.874	
1460	LTV		Note 4.4
1461	Development	.721	.869
1462	Initial Production	.148	
2000	Production Phase	338.160	
2100	Earth Based Fabrication & Assembly	254.430	
2110	SPS System Hardware	176.517	
2111	Satellite	43.137	Note 5.1
2112	Earth Rectenna	133.380	Note 5.2
2120	Launch/Recovery Facility Ops	.996	
2121	Facility Maintenance	.996	Note 5.3

Table 5-6 . LRU Option C Life Cycle Cost (continued)

Cost Element Number	Designation	Cost (Billions of 77 \$)	Volume III Appendix H Reference
2130	Transportation (SDV/SSS)	76.917	Note 6.1
2131	Vehicle Replacement	11.586	Note 6.1
2132	Vehicle Maintenance	30.341	Note 6.2
2133	Spares	—	Note 6.2
2134	Propellants/Gases	3.190	Note 6.3
2135	Shuttle User Charge	31.800	Note 6.4
2200	Lunar Based Fabrication & Assembly	18.420	
2210	Construction/Maintenance Crew	1.440	Note 7.1
2220	Facility/Equipment Operations	15.834	
2221	Power Station	8.516	Note 8.1
2222	Lunar Base Habitat	4.096	Note 8.2
2223	Mining Equipment	.060	Section G. 5.1
2224	Beneficiation Equipment	.013	Note 8.3
2225	Processing Facility	2.612	Note 8.4
2226	Manufacturing	.142	Note 8.5
2227	IO ₂ Liquefaction	.362	Note 8.6
2228	Propellant Depot	.033	Note 8.7
2230	Transportation (LTV)	1.146	
2231	Vehicle Replacement	.318	Note 9.1
2232	Vehicle Maintenance	.178	Note 9.2
2233	Spares	.059	Note 9.2
2234	Propellants/Gases	.591	Note 9.2
2300	Space Based Fabrication & Assembly	65.310	
2310	Construction/Maintenance Crew	4.194	Note 10.1
2320	Facility/Equipment Operations	40.543	
2321	Power Station	1.122	Note 11.1
2322	Space Habitats	17.178	Note 11.2

Table 5- 6. LRU Option C Cycle Cost (continued)

Cost Element Number	Designation	Cost (Billions of 77 \$)	Volume III Appendix H Reference
2323	Space Manufacturing Facility	3.482	Note 11.3
2324	Propellant Depot	.851	Note 11.4
2328	Construction System	17.910	Note 11.5
2330	Transportation (COTV/POTV)	20.573	Note 12.1
2331	Vehicle Replacement	.409	Note 12.1
2332	Vehicle Maintenance	15.040	Note 12.2
2333	Spares	5.014	Note 12.2
2334	Propellants/Gases	.110	Note 12.2
3000	Operations	186.651	Earth Baseline
3100	Satellite	124.629	
3200	Earth Rectenna	62.022	
100	Total Program Cost	660.287	

NOTE: Referenced notes are contained in Appendix H.

Table 5- 7 . LRU Option D Life Cycle Cost.

Cost Element Number	Designation	Cost (Billions of 77 \$)				Volume III Appendix H Reference
1000	RDT&E Phase				145.760	
1100	SPS Hardware			6.270		Earth Baseline
1200	Construction System			20.741		Earth Baseline
1300	Facilities & Equipment			83.332		Sect. G. 4
1310	Earth Based			1.374		
1311	Launch/Recovery		.489			
1312	Propellant Production		.885			
1320	Lunar Based			24.358		
1321	Power Station		10.707			Note 1.1
1322	Lunar Base Habitat		6.756			Note 1.2
1323	Mining Equipment		.050			Sect. G. 5.3
1324	Beneficiation Equipment		.032			Note 1.3
1325	Processing Facility		5.681			Note 1.4
1326	Manufacturing Equipment		.292			Table G-41
1327	Liquefaction Equipment		.771			Note 1.5
1328	Propellant Depot		.069			Table G-4
1330	Space Based			41.019		
1331	Power Station		1.323			Note 2.1
1332	Space Habitats		32.058			
-1	LEO	7.793				Note 2.2
-2	GEO	23.003				Note 2.3
-3	LLO	1.262				Note 2.4
1333	Space Manufacturing		7.158			Table G-41
1334	Propellant Depots		.480			Table G-4

Table 5- 7. LRU Option D Life Cycle Cost (Continued).

Cost Element Number	Designation	Cost (Billions of 77 \$)				Volume III Appendix H Reference
1340	Facility Activation			16.581		
1341	Transportation	13.985				Note 3.1
1342	Initial Prop Depot Supply	.001				Note 3.2
1343	Construction/Maintenance Crew	.288				Note 3.3
1344	Earth Based Facility Operations	.073				Note 3.4
1345	Lunar Based Facility Operations	1.116				Note 3.5
1346	Space Based Facility Operations	1.118				Note 3.6
1400	Transportation				35.417	
1430	POTV			1.660		Note 4.1
1431	Development	1.191				
1432	Initial Production	.469				
1440	COTV			13.145		Table G-16
1441	Development	.690				
1442	Initial Production	12.455				
1450	SDV			14.873		Note 4.2
1451	Development	6.832				
1452	Initial Production	8.041				
1470	LDR			5.739		Note 4.3
1471	Development	5.204				
1472	Initial Production	.535				
2000	Production Phase				314.665	
2100	Earth Based Fabrication & Assembly				238.417	
2110	SPS System Hardware			176.517		
2111	Satellite	43.137				Note 5.1
2112	Earth Rectenna	133.380				Note 5.2

5-27

Table 5-7 . LRU Option D Life Cycle Cost (Continued).

Cost Element Number	Designation	Cost			Volume III Appendix H Reference
		(Billions of 77 \$)			
2120	Launch/Recovery Facility Ops		.733		Note 5.3
2121	Facility Maintenance	.733			
2130	Transportation (SDV/SS)		61.167		Note 6.1 Note 6.1 Note 6.2 Note 6.2 Note 6.3 Note 6.4
2131	Vehicle Replacement	7.771			
2132	Vehicle Maintenance	19.542			
2133	Spares	—			
2134	Propellants/Gases	2.054			
2135	SS User Charges	31.800			
2200	Lunar Based Fabrication & Assembly			25.469	
2210	Construction/Maintenance Crew		1.440		Note 7.1
2220	Facility/Equipment Operations		22.325		Note 8.1 Note 8.2 Sect. G.5.1 Note 8.3 Note 8.4 Note 8.5 Note 8.6 Note 8.7
2221	Power Station	12.687			
2222	Lunar Base Habitat	4.096			
2223	Mining Equipment	.060			
2224	Beneficiation Equipment	.022			
2225	Processing Facility	4.714			
2226	Manufacturing	.142			
2227	O ₂ Liquification	.521			
2228	Propellant Depot	.083			
2230	Transportation (LDR)		1.704		
2231	Vehicle Replacement	.881			
2232	Vehicle Maintenance	.617			Note 9.2
2233	Spares	.206			Note 9.2
2234	Propellants/Gases	—			Note 9.2

Table 5-7 . LRU Option D Life Cycle Cost (Continued).

Cost Element Number	Designation	Cost (Billions of 77 \$)				Volume III Appendix H Reference
2300	Space Based Fabrication & Assembly			50.779		
2310	Construction/Maintenance Crew		4.194			Note 10.1
2320	Facility/Equipment Operations		40.268			
2321	Power Station	1.122				Note 11.1
2322	Space Habitats	17.178				Note 11.2
2323	Space Manufacturing Facility	3.482				Note 11.3
2324	Propellant Depots	.576				Note 11.4
2328	Construction System	17.910				Note 11.5
2330	Transportation (COTV/POTV)		6.317			Note 12.1
2331	Vehicle Replacement	.424				Note 12.1
2332	Vehicle Maintenance	4.417				Note 12.2
2333	Spares	1.473				Note 12.2
2334	Propellants/Gases	.003				Note 12.2
3000	Operations Phase				186.651	Earth Baseline
3100	Satellite			124.629		
3200	Earth Rectenna			62.022		
100	Total Program Cost				647.076	

NOTE: Referenced notes are contained in Appendix H.

Table 5-8 . Summary Program Cost Comparison.

ELEMENT	EARTH BASE LINE	LRU CONCEPT B	LRU CONCEPT C	LRU CONCEPT D
RDT&E/STARTUP	70.586	121.756	135.476	145.760
SPS Hardware	6.270	6.270	6.270	6.270
Construction System	20.741	20.741	20.741	20.741
Facilities & Equipment	16.666	68.775	75.911	83.332
Transportation	26.909	25.970	32.554	35.417
PRODUCTION	656.476	298.325	338.160	314.665
Earth-Based Fab/Assy	619.996	229.462	254.430	238.417
Lunar-Based Fab/Assy	0	2.944	18.420	25.469
Space-Based Fab/Assy	36.480	65.919	65.310	50.779
OPERATIONS	186.651	186.651	186.651	186.651
TOTAL PROGRAM COST (B\$)	913.713	606.732	660.287	647.076
\$/kW	3045.8	2022.5	2201.0	2157.0

NOTES:

1. Based on 1 SPS/Year for 30 years
2. Costs are in billions of 1977 dollars unless otherwise noted.
3. Cost per kilowatt is based on total installed capacity of the SPS fleet of 300GW.

5.3.2 NOMINAL ECONOMIC THRESHOLDS. In order to determine the points at which the LRU concepts become more cost effective, breakeven curves were constructed. These are shown in Figure 5-5 for the nominal cost case. A 90% learning curve was used for the production phase in plotting the curves, thus the curves depict a decreasing unit cost with increasing production. Operations costs are unique in that unit number 1 has 30 years of operation whereas unit number 30 has only 1 year. Costs were allocated accordingly in the breakeven chart.

The intersection point of the Earth Baseline with each LRU concept curve represents the threshold at which the use of lunar resources becomes more cost effective. The thresholds indicated are quite low. Concept B is lowest at 3 satellites, followed by Concept C at 4.6 and Concept D at 5.0 production units. These thresholds agree quite closely with preliminary estimates using the 1975 NASA Ames Summer Study on Space Settlements data. That breakeven was presented in Figure 3-2 on page 3-13. It can be concluded, at least on a nominal basis, that all the LRU concepts are more cost effective than the Earth Baseline. It should be kept in mind, however, that these are single point cost estimates, and a great deal of uncertainty is attached to them. These uncertainties are great enough so that the threshold indicated by the nominal costs may never be achieved. An uncertainty analysis and the effects of uncertainty on the threshold is provided in Section 5.4. It should also be kept in mind that in the present task the timing of funding flows and the time value of money has not been taken into account. These also have an effect on the desirability of a program and are discussed in Section 5.5.

5.3.3 COST RECONCILIATION. Satellite production cost for all LRU concepts is significantly lower than that of the earth baseline. The purpose of this task is to evaluate those differences and attempt to explain the reason for the lower LRU production costs. Since all the LRU concepts are similar, Concept B was chosen as the example program for comparison with the Earth Baseline.

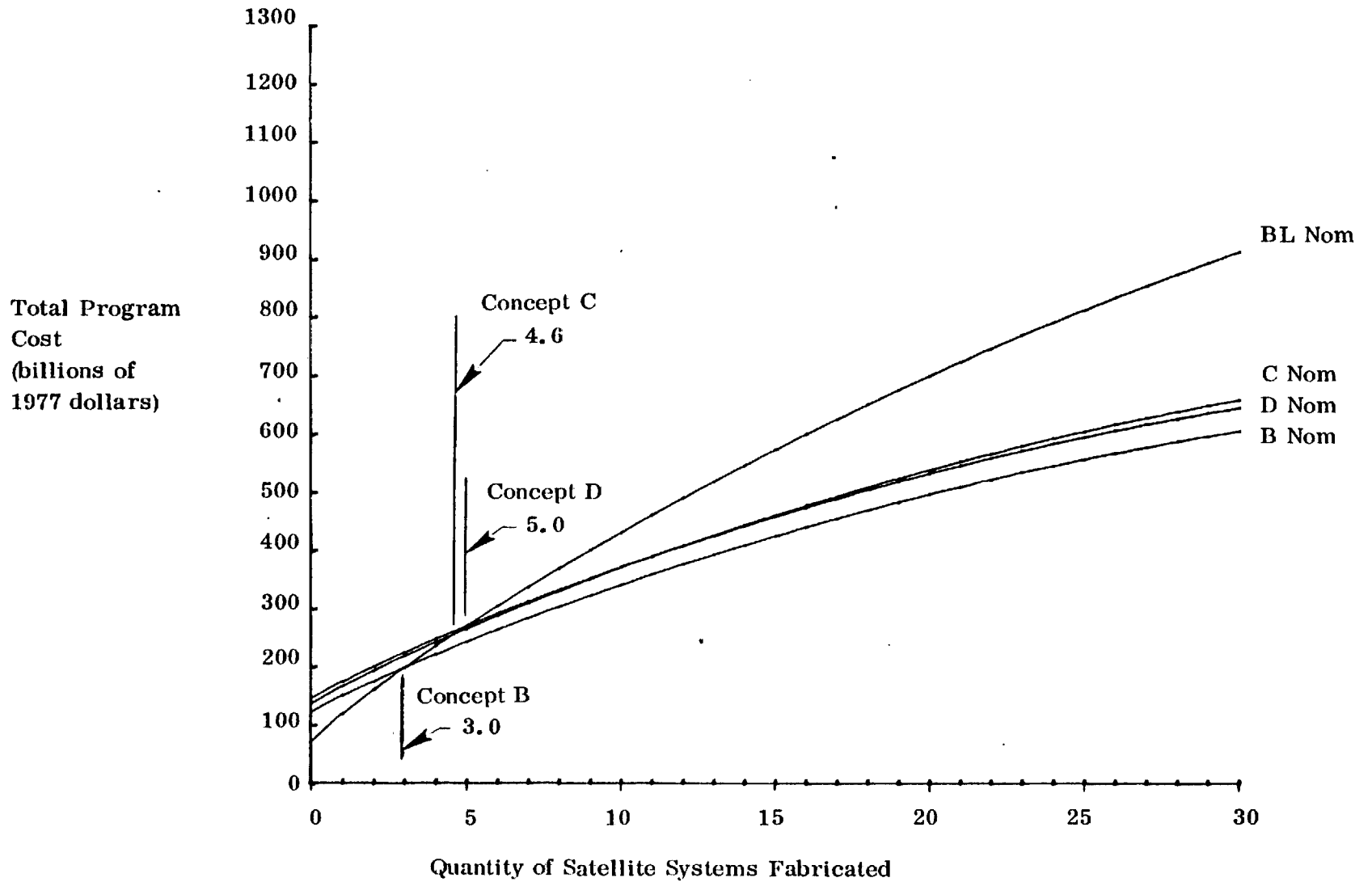
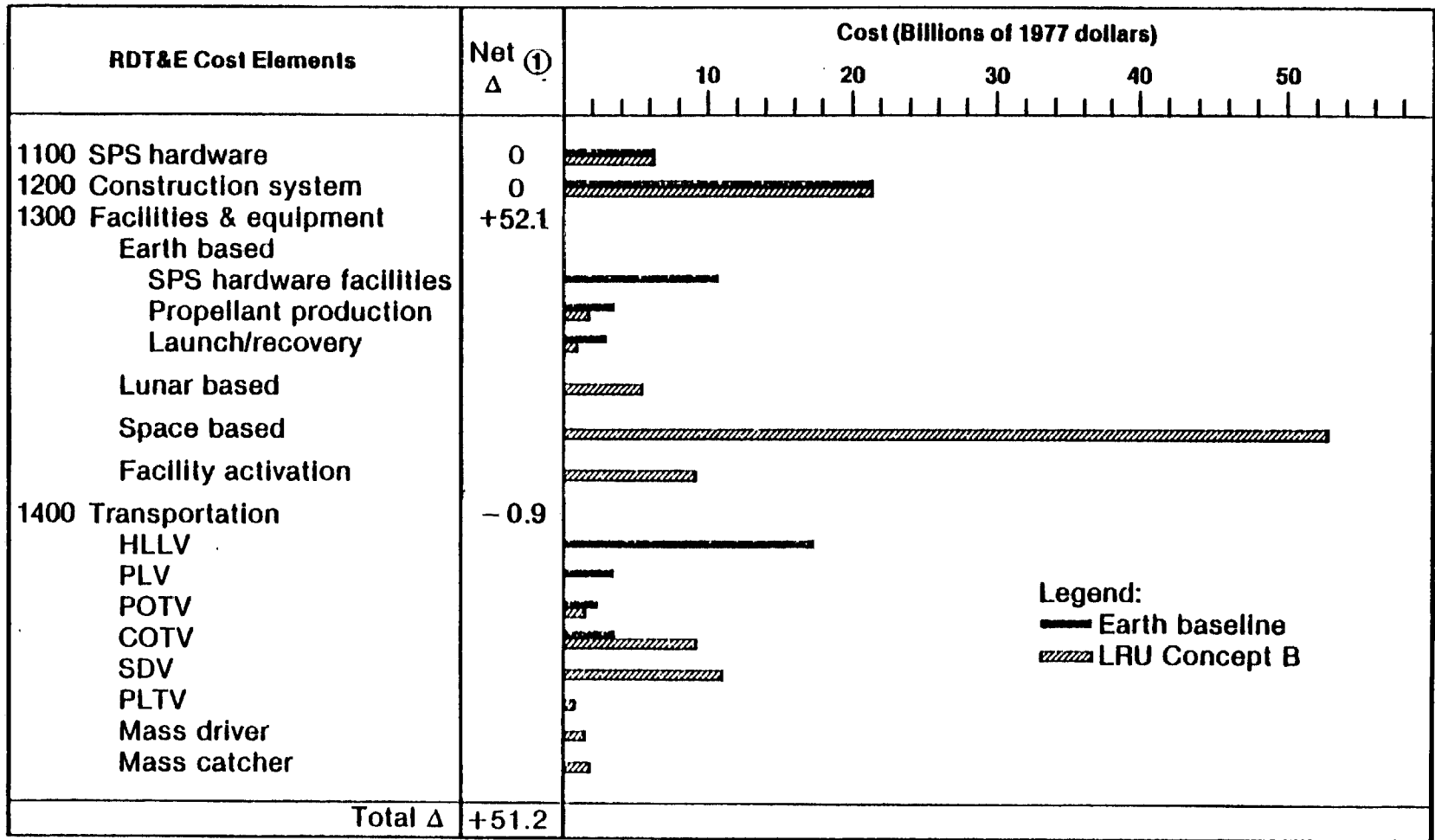

Figure 5-5. Nominal Economic Thresholds for LRU Concepts B, C and D.

The approach to the analysis was to (1) identify all ground rules/assumptions which could significantly affect the outcome (these are shown in Section 5.3.1), (2) provide a bar chart cost comparison for quick visual identification of cost differences, (3) evaluate and explain areas of cost difference and (4) identify cost uncertainty areas or areas that may have been omitted.

Development costs of the LRU concepts are substantially higher than the Earth Baseline. This is due primarily to the higher investment (including development costs) in capital equipment and facilities. Costs for development of the SPS system hardware and the space based construction system are the same for all alternatives. Development costs are compared in Figure 5-6 . Primary differences are in facilities. This is because there are more facilities required for Concept B. In the LRU options the product must be handled from the mine to the manufacture of the end item. In the Earth Baseline most of the SPS hardware is purchased and investment in facilities is limited to about \$10 billion. Transportation development costs are approximately the same in both cases.

Figure 5-7 compares the production and operations costs. Since the SPS system is essentially the same, regardless of production method, operations costs were assumed equal for the Earth Baseline and the LRU concepts. Major differences in Figure 5-7 lie in the production area where LRU Concept B is approximately \$358 billion lower in total program cost. This production cost difference shows up primarily in the cost of transportation and the satellite hardware costs. Including RDT&E costs, the net difference is \$307 billion. The major differences can, perhaps, be better explained if they are classified under the major headings of: transportation and manufacturing. Table 5-9 provides this breakdown. Non-recurring development and facilities costs were amortized and included in the table along with the recurring production charges. The table was constructed by summing the elements from Tables 5-4 and 5-5 into the transportation and manufacturing categories. These are defined as follows:



Note ①: Net difference in billions of 1977 dollars. Positive amounts indicate Concept B is higher in cost

Figure 5-6. Development Cost Comparison.

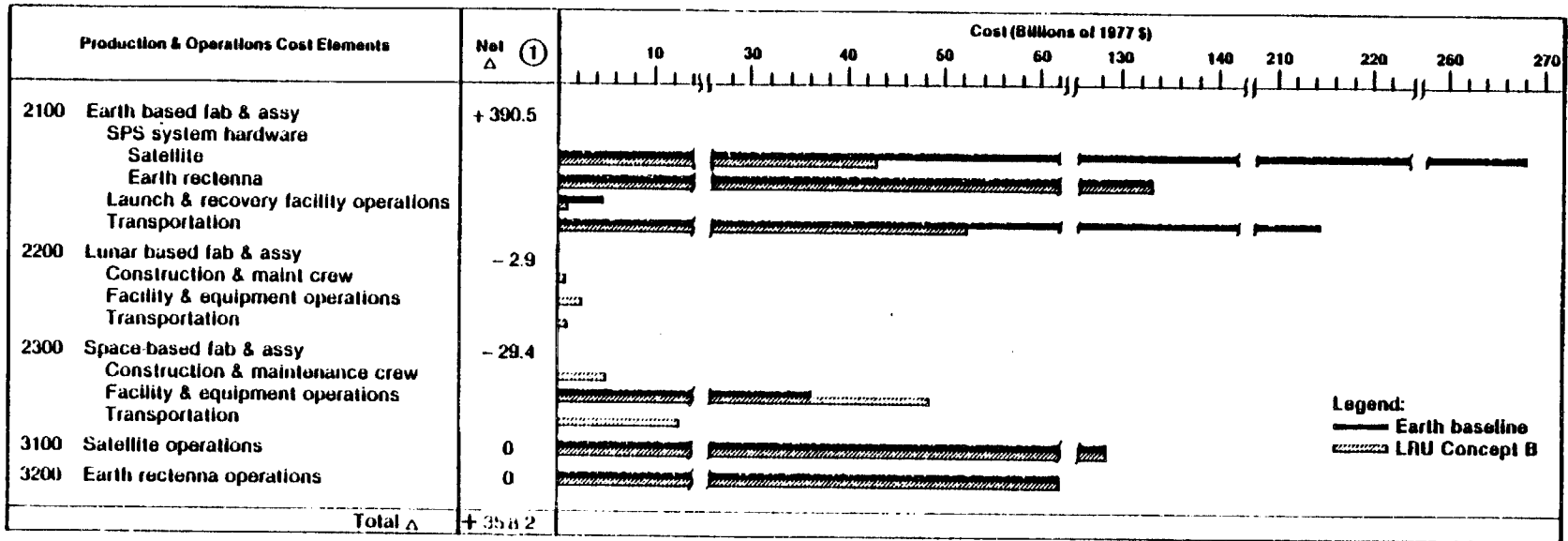

Note ^① : Net difference in billions of 1977 \$. Positive amounts indicate Concept B is lower in cost.

Figure 5-7. Production/Operations Cost Comparison.

Table 5-9. Major cost differences between the Earth Baseline and LRU Concept B.

Category	Earth Baseline			LRU Concept B			Difference
	NR	R	T	NR	R	T	
Transportation			251.8			93.3	158.5
Earth Based	33.2	218.6	251.8	12.4	53.0	65.4	186.4
Lunar Based	-	-	-	1.9	.4	2.3	- 2.3
Space Based	-	-	-	12.9	12.7	25.6	-25.6
Manufacturing							148.4
Earth Based			418.0			182.8	235.2
Satellite	16.6	268.0	284.6	6.3	43.1	49.4	235.2
Rectenna	-	133.4	133.4	-	133.4	133.4	0
Lunar Based	-	-	-	5.4	2.6	8.0	- 8.0
Space Based			57.2			136.0	-78.8
Construction System	20.7	36.5	57.2	20.7	17.9	38.6	18.6
Manufacturing System	-	-	-	62.1	35.3	97.4	-97.4

- Notes:
1. Costs are in billions of 1977 dollars
 2. NR = Non-Recurring Development and Facility Cost Amortization
R = Recurring Production Costs
T = Total costs, excluding the Operations Phase which is the same for all Concept.
 3. Comparison with LRU Concepts C and D is shown in Appendix I.

Transportation — Includes amortization of: vehicle development, propellant production facilities and Launch/Recovery facilities. Also includes cost of initial vehicle fleet, vehicle replacement, vehicle maintenance, vehicle spares and propellants as well as Launch/Recovery facility operations.

Manufacturing — Includes amortization of earth or space based SPS hardware facilities and space construction system as well as facility activation. Also includes the cost of purchased parts and material, labor and facility/equipment overhead (maintenance, spares, propellants).

In the transportation area, Concept B is lower in cost by \$158.5 billion. A savings in this area was expected due to the lower vehicle energy requirements in space and on the moon. The lower transportation costs of Concept B are largely attributable to (1) the high cost of replacing, maintaining, refurbishing and launching the Heavy Lift Launch Vehicle for the Earth Baseline in which there are 11,730 flights and (2) the high Earth Baseline replacement costs for a COTV which is not reusable.

Table 5-9 shows Concept B to be lower in manufacturing costs by \$148.4 billion. Of this amount \$18.6 billion is due to the requirement of only one construction system instead of two. Thus, the Concept B cost to manufacture the SPS hardware, up to the point of on-orbit assembly is \$129.8 billion. This was a surprising result since it would seem reasonable to assume that space manufacturing would be just as costly as earth manufacturing. The \$129.8 billion difference actually results from a combination of factors. These are discussed below in order of importance.

(1) Earth Manufacturing Chain Influences

The earth based manufacturing chain introduces additional, significant costs which are not present in the LRU scenarios. These are (1) the cost of middlemen and (2) the addition of a profit (and the presence of profit pyramiding) by the middlemen, mining companies, processors and manufacturers. Flowcharts of the Earth Baseline and LRU Concept Manufacturing Chains are shown in Figures 5-8 and 5-9. The Earth Baseline chain represents the normal way of doing business today on

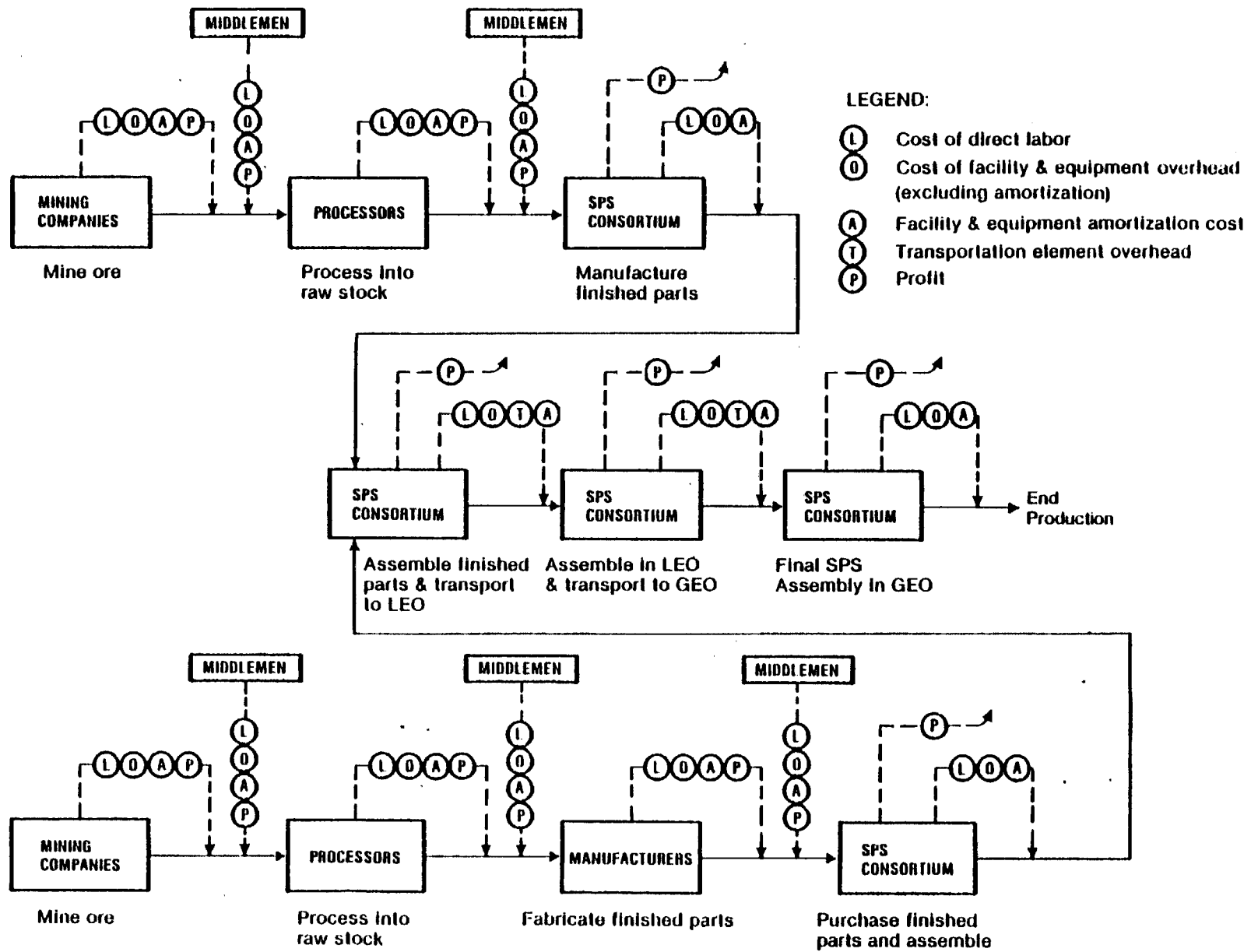

Figure 5-8. Earth Baseline Manufacturing Chain.

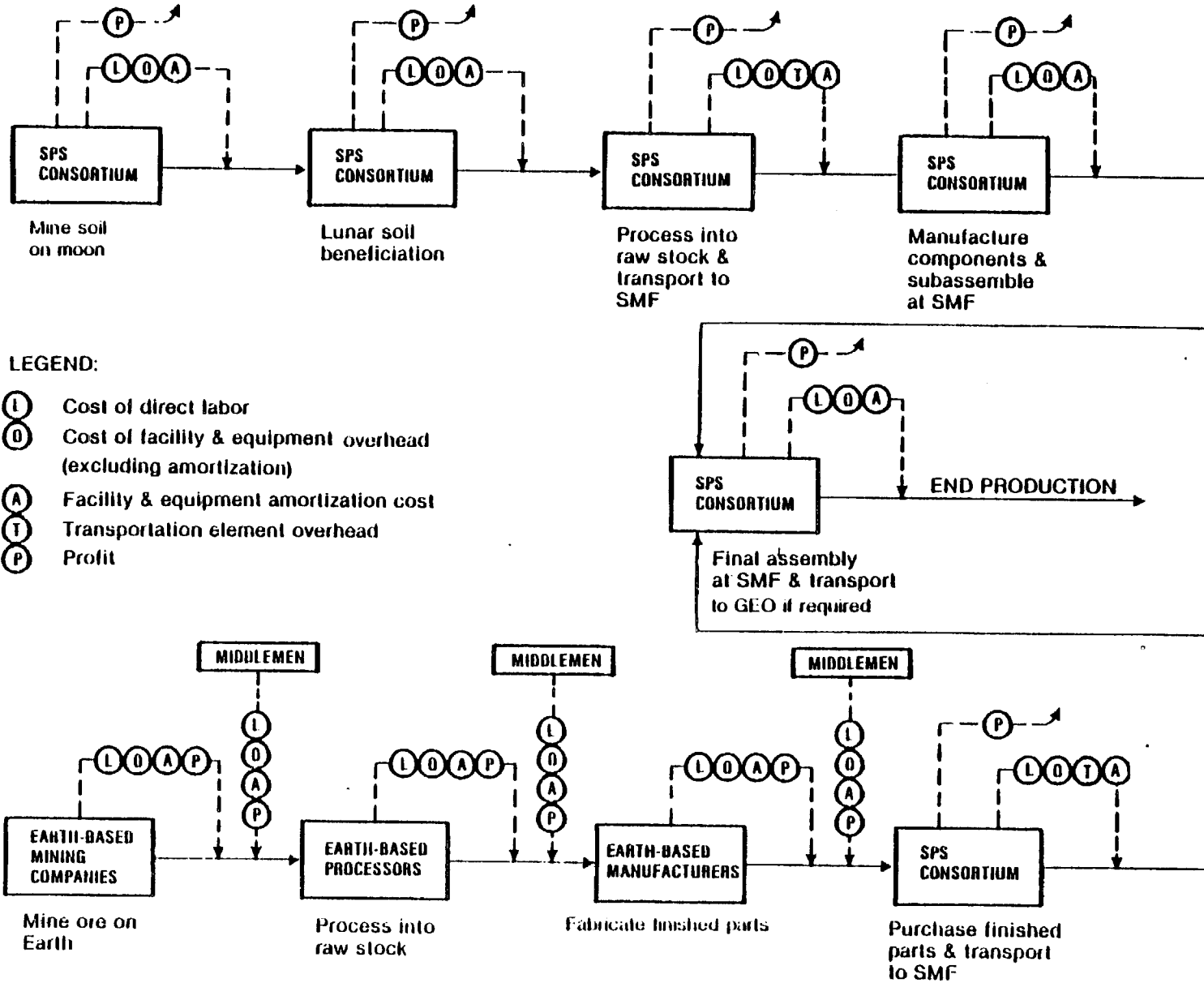

Figure 5-9. LRU SPS Manufacturing Chain.

earth. It consists of hundreds of independent firms, each adding value to the hardware and passing it through the chain. The LRU concepts represent a different way of doing business than we normally see in the United States. It was assumed that all LRU facilities are built, owned and operated by a single entity, such as a group of firms or countries. This assumption eliminates the middleman cost and the addition of profit at each step of the chain. It was assumed that this single entity was in the business of selling power for profit. Since the entity operates its own facilities and isn't selling the hardware the facilities put out, no profits are added and no middlemen are needed. The only profits and middlemen costs in the LRU concept costs lie in the small amount of hardware purchased on earth.

The primary elements in an earth-based manufacturing chain are the mining companies, processors, manufacturers and the middlemen, who transfer the product from one step to the next. A simplified Earth Baseline manufacturing chain is shown in Figure 5-8. It consists of two major flows. The upper one shows the path of the material which eventually ends up as a finished part or assembly which the SPS consortium purchases.

The chain shows the basic cost elements that are added in as the product moves toward the end of the chain. It shows that facility/equipment amortization is indirectly included in the production cost. This tends to overstate the Earth Baseline in relation to Concept B if production costs alone are considered. On a total program cost level, however, the comparisons are valid since capital facilities/equipment subject to amortization are included. The chain also demonstrates the profit pyramiding effect and how the purchase price to the SPS consortium includes the profit of many firms. Assuming each firm adds 10% profit, a dollar's worth of ore leaving the mine becomes \$1.77 worth to the SPS consortium on the bottom chain (44% profit in purchase price) and \$1.46 on the top chain (32% profit in purchase price) due to profit pyramiding. This assumes none of the elements

in the chain change the form; they just add their profit and sell to the next element. With profit added to the value added by processors and manufacturers, the pyramid is even more magnified from the standpoint of total profit dollars added. The same is true if there are more than one processor or manufacturer, which in effect, lengthens the chain. Assuming two processors who each add \$3 in value and two manufacturers who each add \$5 in value, a dollar's worth of ore leaving the mine becomes \$27.71 by the time it is purchased by the consortium on the bottom chain (\$10.71 or 39% profit) and \$9.79 on the top chain (\$2.79 or 28% profit). Depending on the actual product flow, the percentage of profit will vary but it appears to be a significant portion of the purchase price for earth-based manufacturing.

The elements of the lunar based manufacturing chain are similar to those of an earth based chain. The basic difference is that in the LRU concepts the major part of the chain is developed, fabricated and owned by the SPS consortium. The top leg of the chain in Figure 5-9 represents lunar/space manufacturing and the bottom leg represents the 10.4% of SPS material purchased on earth and the facilities fabricated on earth and subsequently installed in space. Aside from the cost of mining it, lunar soil was considered to be a free item.

In the lunar/space based portion of the chain, no profit is added to the production cost. In the earth based portion, the profits of individual firms are added in. The effects of profit pyramiding are negligible here since only a small portion of the manufacturing is performed in this leg, whereas it is significant in the Earth Baseline and contributes a great deal to the cost difference.

The above observations, and the observations on the preceding chart tell us that we cannot compare production costs alone and obtain an equivalent comparison. We must also include the facility/equipment and development costs as if they were amortized. Thus, Total Program Cost is the proper means for comparing the LRU Concepts with the Earth Baseline since it includes all relevant costs. Even though total program costs provide a valid comparison, it might be argued that

the Earth Baseline is being unnecessarily penalized due to profit pyramiding and other inefficiencies resulting from lack of a single ownership. The only way to avoid this argument is to revise the Earth Baseline scenario so that it is an entirely self contained program; similar to the LRU Concepts. Investment and operations costs for mining, processing and manufacturing facilities for the entire Earth Baseline chain would have to be added and would replace the cost of purchased parts.

(2) Manufacturing Facilities

A second factor which contributes to lower LRU Concept costs is in the facilities area. The manufacturing facilities and equipment for the LRU options are specifically designed to turn out hardware for a single end product. This results in a smoother, more efficient manufacturing flow than achievable by a group of earth based firms who have diverse interests. Concept B facilities are also optimally sized to produce the required output whereas existing earth facilities may (1) have excess capacity that may result in higher overhead charges to buyers or (2) be too labor intensive due to insufficient investment in plant/equipment. Finally, the actual facilities which house the equipment are less costly than earth based facilities. This is due to the use of expended external tanks and the fact that enclosures are not required to the extent that they are on earth.

(3) Labor and Overhead

A highly automated manufacturing scenario and the use of robots in the manufacturing process results in lower labor costs for concept B production. In the LRU options only 1500-1600 personnel were required for the entire mining, processing, manufacturing and assembly process. On earth these processes would require many times that amount of workers for the same output. Not only are costs incurred for the direct labor costs of these workers but they are also incurred in the indirect labor of supporting groups and the overhead associated with them.

The final step of the reconciliation costs is the identification of areas which may have been omitted or areas which could be addressed in more detail. Although no major

omissions were found, several areas were identified which contribute to uncertainty in the cost estimates. These are discussed below.

The first area is related to supply/demand shifts and their effect on prices. Two factors which contribute to uncertainty in this area are: (1) the dwindling supply of the earth's natural resources will increase future costs (2) the effects of the SPS program demand on facilities, material and labor prices were not considered.

These factors, if considered, would have a greater cost impact on the Earth Baseline than the LRU concepts. Such assessments would certainly be appropriate in future studies. In fact, the scarcity of earth's natural resources and increasing costs due to the dwindling supply is a major reason for lunar resource utilization.

A second major area of uncertainty is in the number of unknowns in the space/lunar based manufacturing chain. Man's efficiency in and adaptability to space could have major effects on crew sizes required. The amount of earth based support required and the facilities required for those supporting functions has not really been defined. Operation and maintenance costs of space based manufacturing equipment are based on earth experience and could vary significantly from the nominal estimates.

Cost uncertainties are also present because of the state of definition of the hardware and operational characteristics for the optional programs. The scope of the current study was much too limited to define the various LRU elements with a great deal of detail; this is especially true in the area of enclosure facilities for the space/moon manufacturing equipment, space based launch/recovery facilities and earth based support facilities. It is also true for advanced state of the art systems where the details have never really been worked out. The final source of uncertainty is in the development cost of the advanced state of the art elements. Problems in technology and hardware development cannot be foreseen and costs could be higher than predicted.

5.4 COST UNCERTAINTY ANALYSIS

The LRU and Earth Baseline Program Costs, shown in Section 5.1 and 5.3, Tables 5-4 through 5-7, were based on historical data, direct quotes, analyst judgment, extensions of previous estimates and a given set of economic conditions. Costs are also a function of the design parameters of individual systems. Weights, thrusts, size, material types and state of the art all are major influencing factors on cost. At the present stage of LRU analysis nothing is really defined enough to determine costs with a great deal of confidence. The economic conditions of supply and demand are major influencing factors on cost and these cannot be predicted with any certainty ten or twenty years from now. Such pressures as shortages of earth resources, inflation, labor costs and advancement of the state of the art all affect the supply/demand equilibrium points as we perceive them now and shift prices and availability of material and personnel. Who could have foreseen our 2 digit inflation rates of today back in 1957, or who would have ever thought there would be a gasoline shortage? These uncertainties make it both necessary and desirable to perform a cost uncertainty analysis of the data previously derived. This analysis will yield a band of cost estimates rather than an individual estimate. It also helps dispel any notions that the costs in Section 5.3 represent a hard set of numbers derived from a fully defined set of design and performance parameters.

The approach to estimating cost uncertainties is one of combining analyst judgment with quantitative techniques. In this study, standard deviation will be used as a measure of cost uncertainty. The objective is to define an interval around the earlier cost estimates which represents a ± 3 standard derivation and spread from the nominal estimate. This interval theoretically includes 99.7% of the possible variation in costs. The methodology used to accomplish this end is shown in the following paragraphs.

5.4.1 Methodology

For each cost element a percentage was estimated which represents the range of possible costs on either side of the nominal estimate. These percentages are based on the confidence level criteria shown in Table 5-10. Confidence in the cost estimates is a function of such things as data source, method of estimate, degree of design and program definition, state of the art of a given technology, previous production experience, adequacy of ground rules and the time allowed for the estimate. The definitions in Table 5-10 are an attempt at quantifying those variables which affect the validity of the cost estimate and provide for consistency in the confidence level estimates. Each cost element was considered in light of the criteria in Table 5-10 and given a confidence level rating as shown in Table 5-11. An average of the four categories yielded an overall rating for each cost element.

To convert the confidence level ratings to a percentage confidence band the following assumptions were made:

- 1) For Production and Operations costs a confidence level of 4 represents a 3 standard deviation dispersion about the nominal estimate of $\pm 10\%$. A Confidence Level of 1, at the other extreme, represents a $\pm 100\%$ dispersion.
- 2) For Development Costs a Confidence Level of 4 represents a 3-standard deviation dispersion about the nominal estimate of $\pm 20\%$. A Confidence Level of 1, at the other extreme, represents a $\pm 200\%$ dispersion.

The dispersions for Development cost elements are double those of the Production or Operations phase elements. This is due to the greater number of unknowns in a development program as opposed to the production or the operation of a system. The limits are based on analyst judgment and are felt to represent a realistic range of possible variations from the nominal.

Using the above assumptions, Confidence Level can be converted to a percentage uncertainty range using the following linear equations:

Table 5-10. Confidence Level Criteria for Cost Uncertainty Estimates

	<u>CONFIDENCE LEVEL 1</u> LOW	<u>CONFIDENCE LEVEL 2</u> MEDIUM LOW	<u>CONFIDENCE LEVEL 3</u> MEDIUM HIGH	<u>CONFIDENCE LEVEL 4</u> HIGH
<u>ESTIMATING CONDITIONS</u>	<u>Estimating Time and Information Access</u> Completely inadequate amount of time provided to make the estimate or there is a complete lack of access to useful data sources. <u>Ground Rules and Assumptions</u> No guidance was provided on ground rules and all assumptions made by the estimator were arbitrary.	<u>Estimating Time and Information Access</u> A very short due date or major problems of access to available data tend to make this estimate highly uncertain. <u>Ground Rules and Assumptions</u> Very little guidance was provided relative to ground rules. Many of the assumptions made by the estimator were considered quite arbitrary.	<u>Estimating Time and Information Access</u> A more accurate estimate could have been made if freer access or more time had been available to research known data sources. <u>Ground Rules and Assumptions</u> Ground rules were generally adequate. Many of the assumptions were authenticated but a substantial number are considered questionable.	<u>Estimating Time and Information Access</u> There were minor problems of access to available data and there was generally sufficient time to define and cost the item. <u>Ground Rules and Assumptions</u> Major ground rules were provided and most of the assumptions were authenticated.
<u>NATURE OF THE ITEM</u>	<u>State-of-the-Art</u> The item is substantially beyond the current state-of-the-art. Major development work is required. <u>Production Experience</u> No production of any kind has been started.	<u>State-of-the-Art</u> The item is slightly beyond the state-of-the-art and some development work will be required. <u>Production Experience</u> Experimental laboratory fabrication of a similar item is in process.	<u>State-of-the-Art</u> The item is within the state-of-the-art but no commercial counterpart exists. <u>Production Experience</u> A prototype of the item has been produced.	<u>State-of-the-Art</u> The item will involve a minor modification of commercial or standard aerospace issue items. <u>Production Experience</u> The item has been produced in limited quantity.
<u>ITEM DESCRIPTION</u>	<u>Design Definition</u> No work done on design definition except for defining major parameters (e.g., total weight, power) on a total basis. Subsystems not defined. Cost analyst assumptions used for identification of subsystems and their weight breakdown. <u>Operating Program Characteristics</u> None of the OPC for using the item have been formulated.	<u>Design Definition</u> Design has been defined on a cursory basis. Subsystem parameters have been estimated by engineering using similar studies. <u>Operating Program Characteristics</u> The general outline of the OPC under which the item will be used has been only tentatively defined and many specific details are lacking.	<u>Design Definition</u> Concept subsystem parameters have been defined in detail through engineering study but have not been substantiated. Requirements driving the design are not firm. <u>Operating Program Characteristics</u> The general outline of the OPC has been formulated, but many specific details are lacking.	<u>Design Definition</u> Concept design has been defined in detail. Subsystem parameters and characteristics have been identified and substantiated. The design is driven by firm requirements. <u>Operating Program Characteristics</u> The OPC have been substantially defined, but are under review or revision.
<u>COST METHODS AND DATA</u>	<u>Methods</u> The estimate is almost a poor guess and little or no confidence can be placed in it. <u>Data</u> An almost total lack of current and reliable relevant data make the cost estimate completely uncertain.	<u>Methods</u> A highly arbitrary rule-of-thumb has been used. <u>Data</u> The data used to make the estimate highly suspect, very sparse in quantity, and characterized by major inconsistencies.	<u>Methods</u> A commonly used rule-of-thumb cost factor, but with no supporting backup, has been used. <u>Data</u> The data used have been obtained from official or standard sources. Notable inconsistencies, lack of currency, gaps in data reduce the confidence in the estimate.	<u>Methods</u> The basic method used to derive the cost is well documented, but no double-check or authentication has been possible. <u>Data</u> The data used are generally relevant and from a reputable source. They are incomplete, preliminary, or not completely current, however.

Table 5-11. Cost Element Confidence Levels and Uncertainty Range Estimates

Element	CONFIDENCE LEVELS					Uncertainty Range (±%)
	Estimating Conditions	Nature of the Item	Item Description	Cost Methods & Data	Overall Rating	
RDT&E						
SPS Hardware	4	2	3	4	3.25	65.0
Construction System	4	1	3	4	3.00	80.0
Facilities & Equipment						
Earth Based	3	4	2	4	2.25	65.0
Lunar Based	2	1.5	2	3	2.13	132.2
Space Based	2	1.5	2	3	2.13	132.2
Activation	2	1.5	3	3	2.38	117.2
Transportation						
HLLV	4	2	3	4	3.25	65.0
PLV	4	2	3	4	3.25	65.0
POTV	3	2	3	3	2.75	95.0
COTV	3	1	2	2	2.0	140.0
SDV	3	2	2	4	2.75	95.0
LTV/PLTV	2	1	1	2	1.5	170.0
LDR	2	1	1	2	1.5	170.0
Mass Driver	1	1	1	2	1.25	185.0
Mass Catcher	1	1	1	2	1.25	185.0
Production						
Earth Based Fab/Assy						
SPS System Hardware	4	2	3	4	3.25	32.5
Launch/Recovery Fac. Ops.	3	4	2	4	3.25	32.5
Transportation	3	2	2	3.5	2.63	51.1
Lunar Based Fab/Assy						
Constr/Maint. Crew	4	1	2	4	2.75	47.5
Facility/Equip. Ops	3	1	2	3	2.25	62.5
Transportation	3	2	2	3	2.5	55.0
Space Based Fab/Assy						
Constr./Maint Crew	4	1	2	4	2.75	47.5
Facility/Equip Ops	3	1	2	3	2.25	62.5
Transportation	3	2	2	3	2.5	55.0
Operations						
Satellite	2	2	2	3	2.25	62.5
Earth Rectenna	2	2	2	3	2.25	62.5

Development: $U = 60X + 20$

Production/Operations: $U = 30X + 10$

where: $U =$ Uncertainty range ($\pm\%$)

$X = (4 - \text{Confidence Level Rating})$

The overall confidence level ratings were converted to percentage uncertainties using the above equations and are shown in Table 5-11. This range represents a ± 3 standard deviation variation from the nominal cost estimate for each element and provides an estimate of the uncertainty in the cost estimate for that particular element.

In Table 5-12 the percentages were multiplied by the nominal cost estimates from Tables 5-5 , 5-6 and 5-7 to provide a ± 3 standard deviation uncertainty range for each element in terms of dollars. Standard deviations for each program phase were determined by summing the variances (σ^2) of the individual elements within the phase and taking the square root:

$$\sigma_{\text{Phase}} = \sqrt{\sigma_1^2 + \sigma_2^2 + \dots + \sigma_n^2}$$

Each program phase standard deviation was multiplied by 3 to provide a $\pm 3\sigma$ cost uncertainty range. These uncertainties are shown in the boxes in Table 5-12.

Using these measures of dispersion it can be stated that we are 99.7% confident that actual, future costs will fall within the following ranges:

	<u>$\pm 3\sigma$ Cost Range (billions \$)</u>
Earth baseline	631-1197
Concept B	374-839
Concept C	427-893
Concept D	416-878

Table 5-12. Program Phase Cost Uncertainty Ranges (billions of 1977 dollars).

Cost Element	Uncertainty Range (%)	Concept B			Concept C			Concept D			Earth Baseline		
		Nominal Cost	+3σ	σ ²	Nominal Cost	+3σ	σ ²	Nominal Cost	+3σ	σ ²	Nominal Cost	+3σ	σ ²
RD&E													
SPS Hardware	65.0	6.270	4.076	1.846	6.270	4.076	1.846	6.270	4.076	1.846	6.270	4.076	1.846
Construction System	80.0	20.741	16.593	30.591	20.741	16.593	30.591	20.741	16.593	30.591	20.741	16.593	30.591
Facilities & Equipment													
Earth Based	65.0	1.338	.870	.084	1.748	1.136	.143	1.374	.893	.089	16.666	10.833	13.039
Lunar Based	132.2	5.338	7.067	5.633	19.525	25.812	74.029	24.358	32.201	115.214	—	—	—
Space Based	132.2	52.756	69.743	540.454	41.248	54.530	330.389	41.019	54.227	326.731	—	—	—
Facility Activation	117.2	9.293	10.891	13.180	13.390	15.693	27.364	16.581	19.433	41.960	—	—	—
Transportation													
HLLV	65.0	—	—	—	—	—	—	—	—	—	17.826	11.587	14.917
PLV	65.0	—	—	—	—	—	—	—	—	—	3.314	2.154	.516
POTV	95.0	1.667	1.584	.279	1.661	1.578	.277	1.660	1.577	.276	2.369	2.251	.563
COTV	140.0	9.342	13.079	19.006	16.318	22.845	57.980	13.145	18.403	37.630	3.400	4.760	2.518
SDV	95.0	11.090	10.536	12.333	13.706	13.021	18.838	14.873	14.129	22.182	—	—	—
LTV/PLTV	170.0	.443	.753	.063	.869	1.477	.242	—	—	—	—	—	—
LDR	170.0	—	—	—	—	—	—	—	—	—	—	—	—
Mass Driver	185.0	1.500	2.775	.856	—	—	—	5.739	9.756	10.576	—	—	—
Mass Catcher	185.0	1.928	3.567	1.414	—	—	—	—	—	—	—	—	—
Nominal Cost		121.756			135.476			145.760			70.586		
Sum of the Variances				625.639			541.708			587.095			63.990
RD&E Uncertainty Range (+ 3σ)			<u>75.038</u>			<u>69.824</u>			<u>72.690</u>			<u>23.998</u>	
Production													
Earth Based Fab/Assy													
SPS System Hardware	32.5	176.517	57.368	365.677	176.517	57.368	365.677	176.517	57.368	365.677	401.391	130.452	1890.860
Launch/Recovery Facilities Ops	32.5	.680	.221	.005	.996	.324	.012	.733	.238	.006	4.200	1.365	.207
Transportation	51.1	52.265	26.707	79.254	76.917	39.305	171.650	61.167	31.256	108.551	214.405	109.561	1333.734
Lunar Based Fab/Assy													
Construction/Maintenance Crew	47.5	.173	.082	.001	1.440	.684	.052	1.440	.684	.052	—	—	—
Facility & Equipment Ops	62.5	2.366	1.479	.243	15.834	9.896	10.882	22.325	13.953	21.632	—	—	—
Transportation	55.0	.405	.223	.006	1.146	.630	.044	1.704	.937	.098	—	—	—
Space Based Fab/Assy													
Construction/Maintenance Crew	47.5	5.044	2.396	.638	4.194	1.992	.441	4.194	1.992	.441	—	—	—
Facility & Equipment Ops	62.5	48.152	30.095	100.634	40.543	25.339	71.343	40.268	25.168	70.378	36.480	22.800	57.760
Transportation	55.0	12.723	6.998	5.441	20.573	14.226	22.486	6.317	3.474	1.341	—	—	—
Nominal Cost		298.325			338.160			314.665			656.476		
Sum of the Variances				551.899			642.587			568.176			3282.561
Production Uncertainty Range (+ 3σ)			<u>70.478</u>			<u>76.048</u>			<u>71.509</u>			<u>171.881</u>	
Operations													
Satellite	62.5	124.629	77.893	674.147	124.629	77.893	674.147	124.629	77.893	674.147	124.629	77.893	674.147
Earth Rectenna	62.5	62.022	38.764	166.959	62.022	38.764	166.959	62.022	38.764	166.959	62.022	38.764	166.959
Nominal Cost		186.651			186.651			186.651			186.651		
Sum of the Variances				811.106			841.106			841.106			841.106
Operations Uncertainty Range (+ 3σ)			<u>87.005</u>			<u>87.005</u>			<u>87.005</u>			<u>87.005</u>	

The question is now whether or not we can ascertain the presence of an economic threshold with such broad cost ranges. This question is addressed in the following section.

5.4.2 ECONOMIC THRESHOLDS. Figures 5-10 through 5-12 are plots of the cost ranges from Table 5-12. They are plotted in a similar fashion to the nominal breakeven curve shown in Figure 5-5 . A 90% learning curve was assumed. The cost range at zero production units represents the range of probable development costs. The total dispersion for production and operations was equally allocated among production units, which results in a confidence band that gradually grows wider as production is increased.

In order to determine the presence of an economic threshold within the 30-unit production phase, the maximum limit of the LRU concept range must cross the minimum limit of the Earth Baseline range. This does not occur in any of the three cases.

The crossover could occur at any point in the overlap area of the two ranges, or at some greater number of production quantity. Thus, for confidence intervals which include 99.7% of possible outcomes, it cannot be determined which concept is more cost effective.

The above analysis indicated that, for a 99.74% (3σ) certainty level, no firm conclusion can be reached regarding the crossover point. It might be interesting to take the analysis one step further and determine the levels of certainty at which a definite threshold can be determined. This can be accomplished by narrowing down the 3σ bands shown in Figure 5-10 through 5-12 in small increments and determining the crossover points for each iteration. This process is shown in Figure 5-13. Step (a) shows the condition found with a $\pm 3\sigma$ uncertainty range; that is, no crossover occurs.

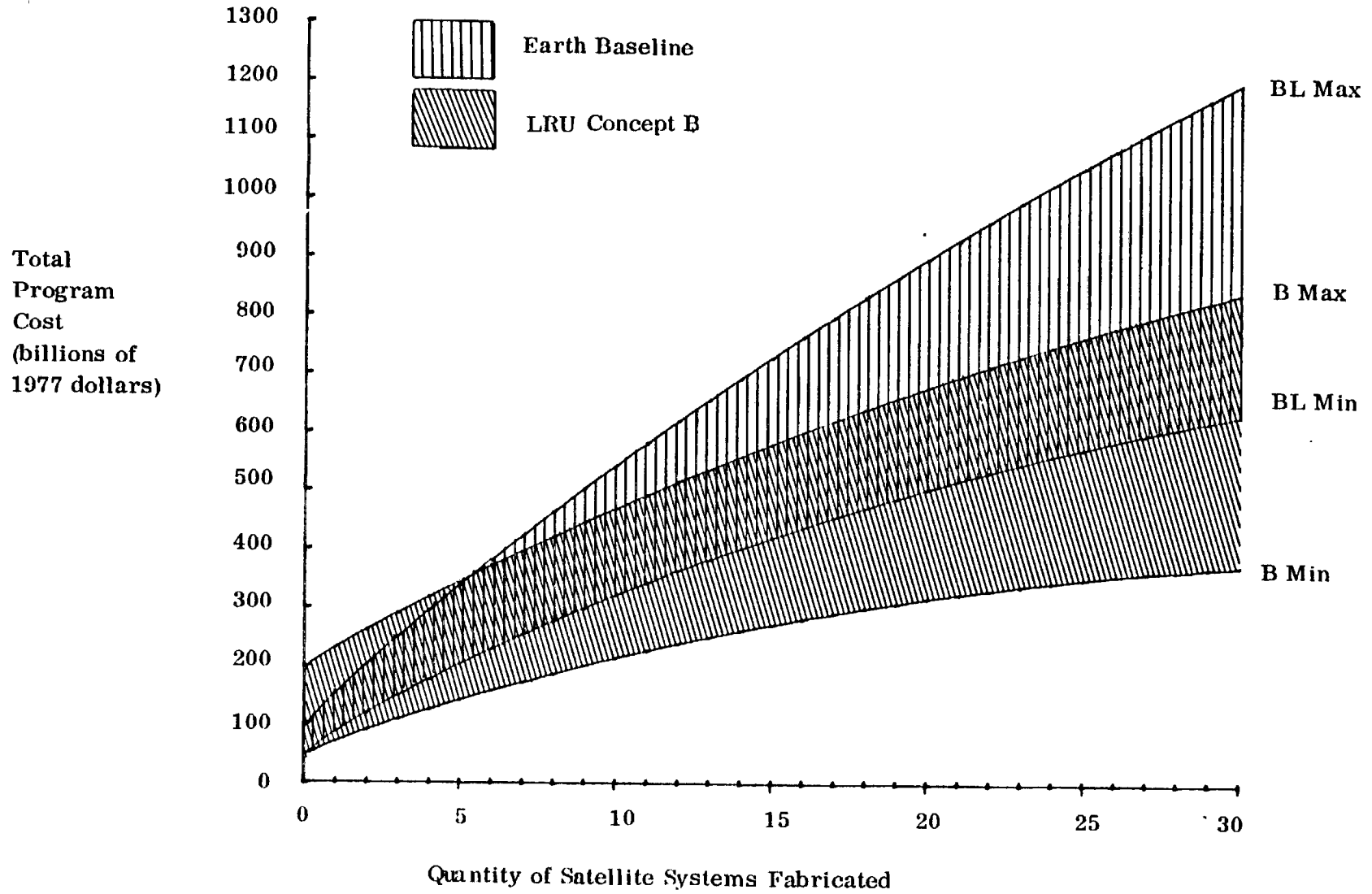

Figure 5-10. LRU Concept B Threshold With $\pm 3\sigma$ Uncertainty Ranges.

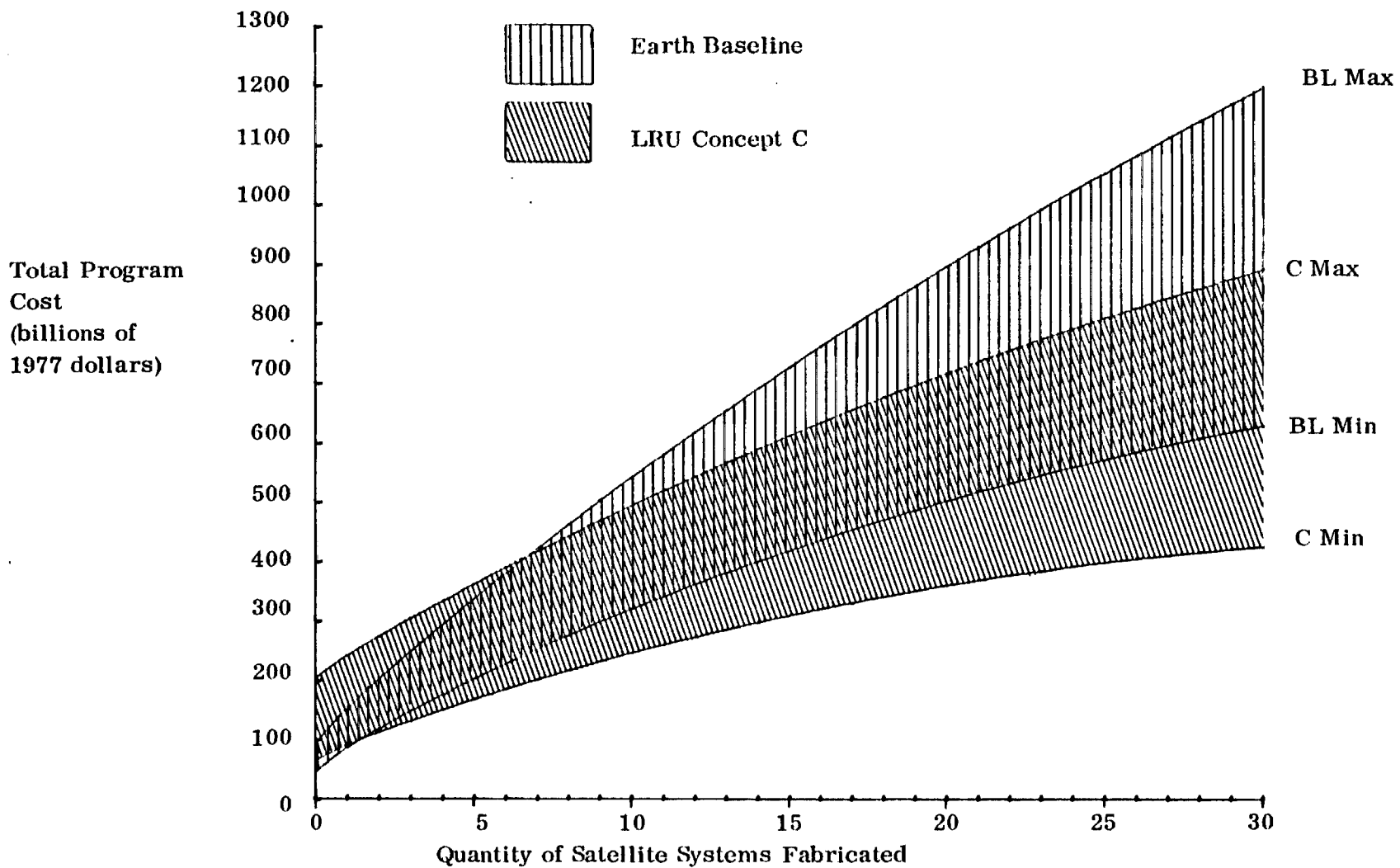

Figure 5-11. LRU Concept C Threshold With $\pm 3\sigma$ Uncertainty Ranges.

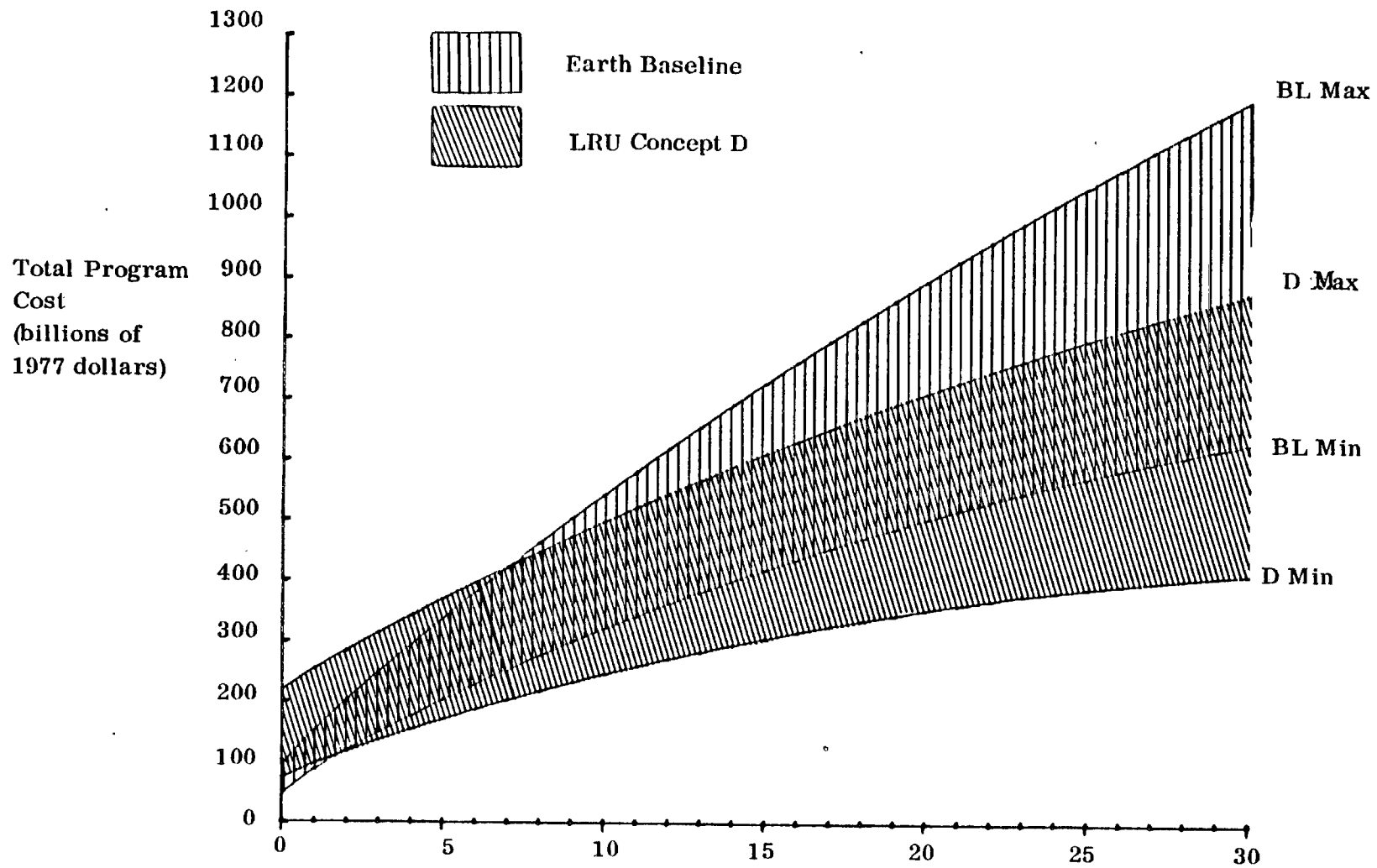

Figure 5-12. LRU Concept D Threshold With $\pm 3\sigma$ Uncertainty Ranges.

Steps (b), (c) and (d) show successive iterations of narrowing the range from a $\pm 2\sigma$ range to a $\pm 0\sigma$ range. It should be noted again here that the relevant crossover point is the point where the high side of the LRU concept range becomes less than the low side of the Earth Baseline range. This point is identified with a bold dot in Figure 5-13.

As the uncertainty range is narrowed, maximum crossover points can be detected; first at very high production numbers, then at lower and lower quantities as the uncertainty band becomes smaller. Due to the overlap of the earth baseline and LRU option uncertainty bands, the crossover points are of a cumulative nature; that is, they represent the number of units at or below which the LRU options become cost effective. The initial uncertainty bands determined in Table 5-12 represent ranges of costs within which 99.7% of the actual costs would fall. As these bands are narrowed, it becomes less and less probable that actual, future costs would fall within their smaller ranges. The limit is reached in Step (d) of Figure 5-13 where the ranges have become a point estimates of cost. These estimates represent the lowest probability of attainment since it is not likely the actual program costs will be exactly as predicted. Although the narrower certainty bands allow us to ascertain the presence of a cost effectiveness threshold we are less certain that actual costs will be contained within these intervals.

The curves in Figure 5-14 were constructed using the process depicted in Figure 5-13. They were constructed for uncertainty bands ranging from $\pm 3\sigma$ to $\pm 0\sigma$. They show the crossover points detected for the various uncertainty ranges. The

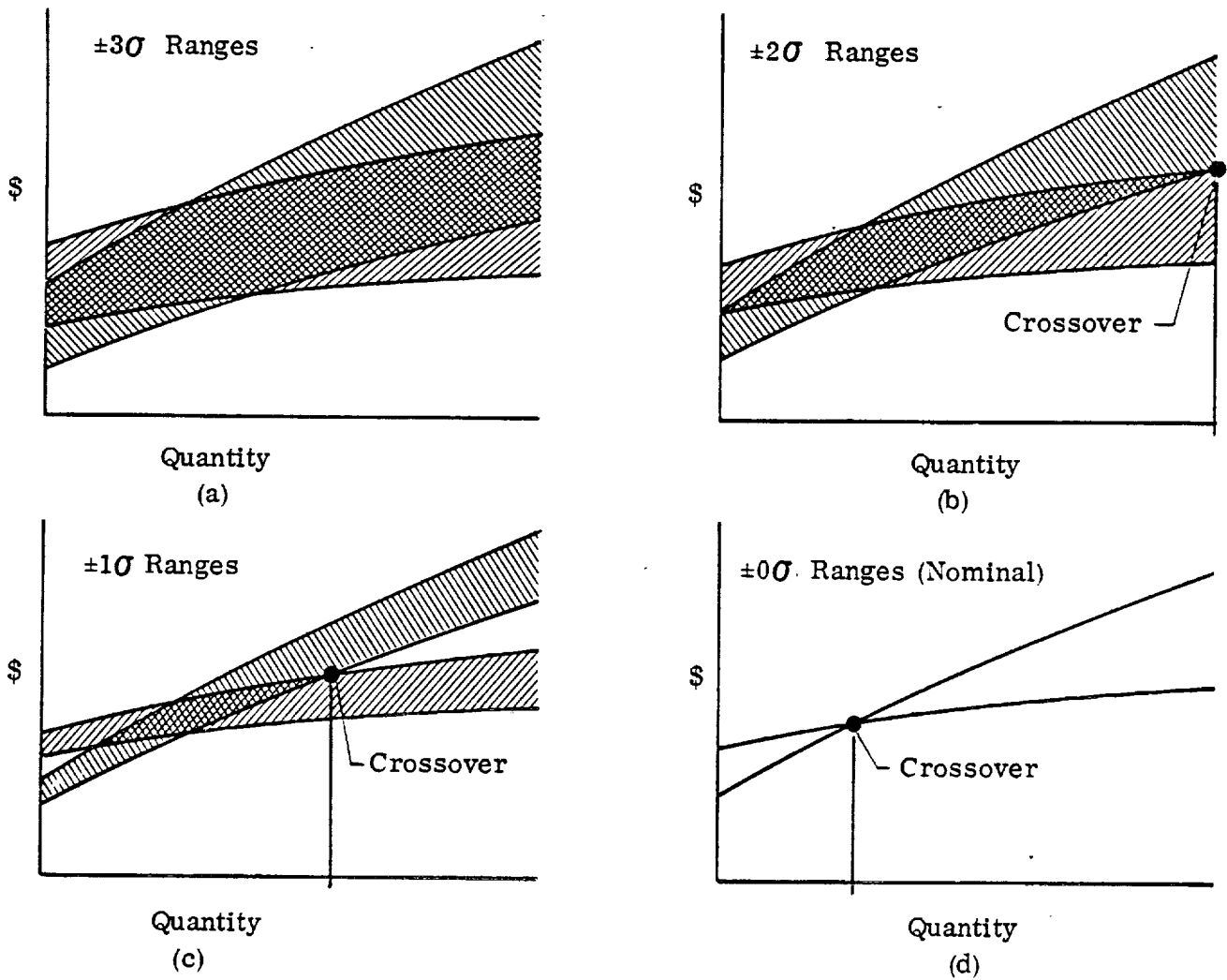

Figure 5-13. Iterative process required to determine crossover as a function of cost uncertainty ranges.

uncertainty bands are expressed in terms of the probability that actual costs will fall within the corresponding standard deviation ranges. The ordinate could have also been expressed in terms of standard deviations, where 99.7% represents $\pm 3\sigma$; 95.4%, $\pm 2\sigma$; 68.3%, $\pm 1\sigma$, and so on. The maximum crossover points indicate the number of production units at or below which the LRU options become more cost effective.

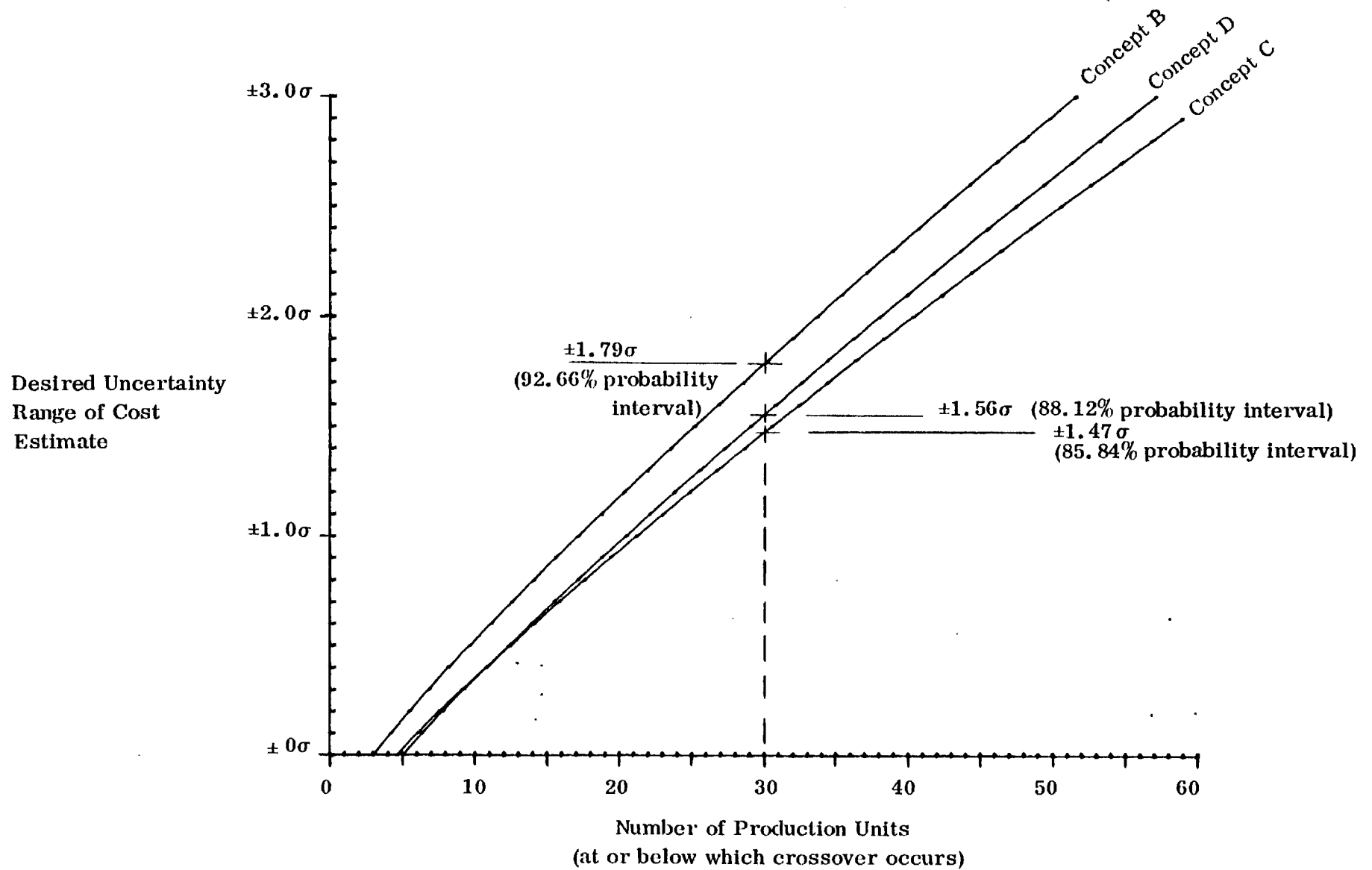

Figure 5-14. Identification of Maximum Crossover Points for Various Cost Uncertainty Ranges.

Figure 5-14 is useful in determining the probability or uncertainty range required to achieve a crossover at 30 units or less. From the figure, the ranges for each option were determined and are shown below, together with their corresponding width in standard deviations.

	Probability Interval	Std Deviation Range	Probability of Crossover
Concept B	92.7%	$\pm 1.79\sigma$	92.8%
Concept C	85.8%	$\pm 1.47\sigma$	86.3%
Concept D	88.1%	$\pm 1.56\sigma$	88.5%

Thus, in the case of Concept B, if we are willing to accept a cost uncertainty range which encompasses 92.7% of all possible outcomes, then we can state that a threshold will be reached at or before 30 production units. Similar statements can be made for LRU Concepts C and D for 85.8% and 88.1% probabilities.

One of the values of this exercise is that it allows us to make a determination of the probability of crossover at or before 30 units for each concept. The probability of this crossover is the joint probability of the Earth Baseline being at or above the lower end of its range and the LRU concepts being at or lower than the upper end of their ranges. The probabilities are also shown in the above table.

5.4.3 THRESHOLD SENSITIVITY TO MANUFACTURING COSTS. As was mentioned previously, the fact that nominal manufacturing costs in space were much lower than on earth is a surprising result. Transportation costs were expected to be lower but manufacturing costs were expected to be more or less equal. The cost reconciliation section identified several reasons for this cost difference. The primary one being due to ownership by a single entity versus ownership by many independent firms. This resulted in additional middlemen costs and profit pyramiding which are not present in the LRU options. Although ownership by a single entity and the vertically integrated manufacturing chain appear to be reasonable assumptions for the space-based scenarios, it might be argued that this difference in the manufacturing chain unfairly penalizes the Earth Baseline.

If we assume for a moment that the LRU scenarios include independent firms and middlemen, the manufacturing costs would increase. Not only because of profits and additional overhead, but also because of lost efficiencies in the manufacturing process. To test the sensitivity of the economic crossover point to such a scenario it will be assumed that the manufacturing costs of the LRU concepts are the same as those in the Earth Baseline. From Section 5.3.3 the total difference in manufacturing between Concept B and the Earth Baseline is \$129.8 billion. Similar analyses for Concepts C and D yielded \$117 billion and \$102.8 billion, respectively. These data are shown in Appendix I. If these amounts are added to the LRU concept manufacturing costs we can determine the effects on the crossover point and uncertainty bands.

The cost differences were allocated to the lunar and space-based manufacturing costs using ratios of element costs to totals. Costs were further allocated to RDT&E and Production by ratios and the following results were obtained.

<u>Concept B Cost Element</u>	<u>Amount to be Added to LRU Manufacturing Cost (billions \$)</u>		
	<u>B</u>	<u>C</u>	<u>D</u>
RDT&E			
Lunar based (1320)	6.65	19.30	18.94
Space based (1330)	76.48	54.04	44.73

Concept B Cost Element	Amount to be Added to LRU Manufacturing Cost (billions \$)		
	B	C	D
Production			
Lunar based fab/assy			
Construction/maintenance crew (2210)	.22	1.43	1.12
Facility equipment ops (2220)	2.98	15.70	17.36
Space based fab/assy			
Construction/Maintenance crew (2310)	4.12	2.49	1.95
Facility equipment ops (2320)	39.35	24.04	18.80
TOTAL	\$129.8	\$117.0	\$102.8

Adding the above values to the LRU concept values in Table 5-12, the following new values were calculated:

Concept	Element	Nominal	$\pm 3\sigma$	3σ Range
B	RDT&E	204.886	173.660	31.226 - 378.546
B	Production	344.995	84.110	260.885 - 429.105
C	RDT&E	208.816	140.494	68.322 - 349.310
C	Production	381.820	84.074	297.746 - 465.894
D	RDT&E	209.430	132.035	77.395 - 341.465
D	Production	353.795	79.149	274.646 - 432.944

Economic thresholds can now be determined in a similar manner as the previous analyses. The results are shown in Figures 5-15, 5-16, and 5-17. The nominal crossovers are shown in Figure 5-15. Even with the added amounts, the LRU concepts are still more cost effective than the Earth Baseline. The added costs have a significant effect on the 3σ bandwidth of LRU concepts. The addition of the RDT&E more than doubled the nominal costs for space and lunar facilities and equipment. This, in turn, increased the dispersions for development and resulted in a much wider 3σ confidence band. The bands are plotted in Figure 5-16 for Concept B. Similar results would be obtained for Concepts C and D. The conclusions which can be reached are the same as before. The bandwidths are too wide to determine if an economic threshold will be reached within the 30-unit production run.

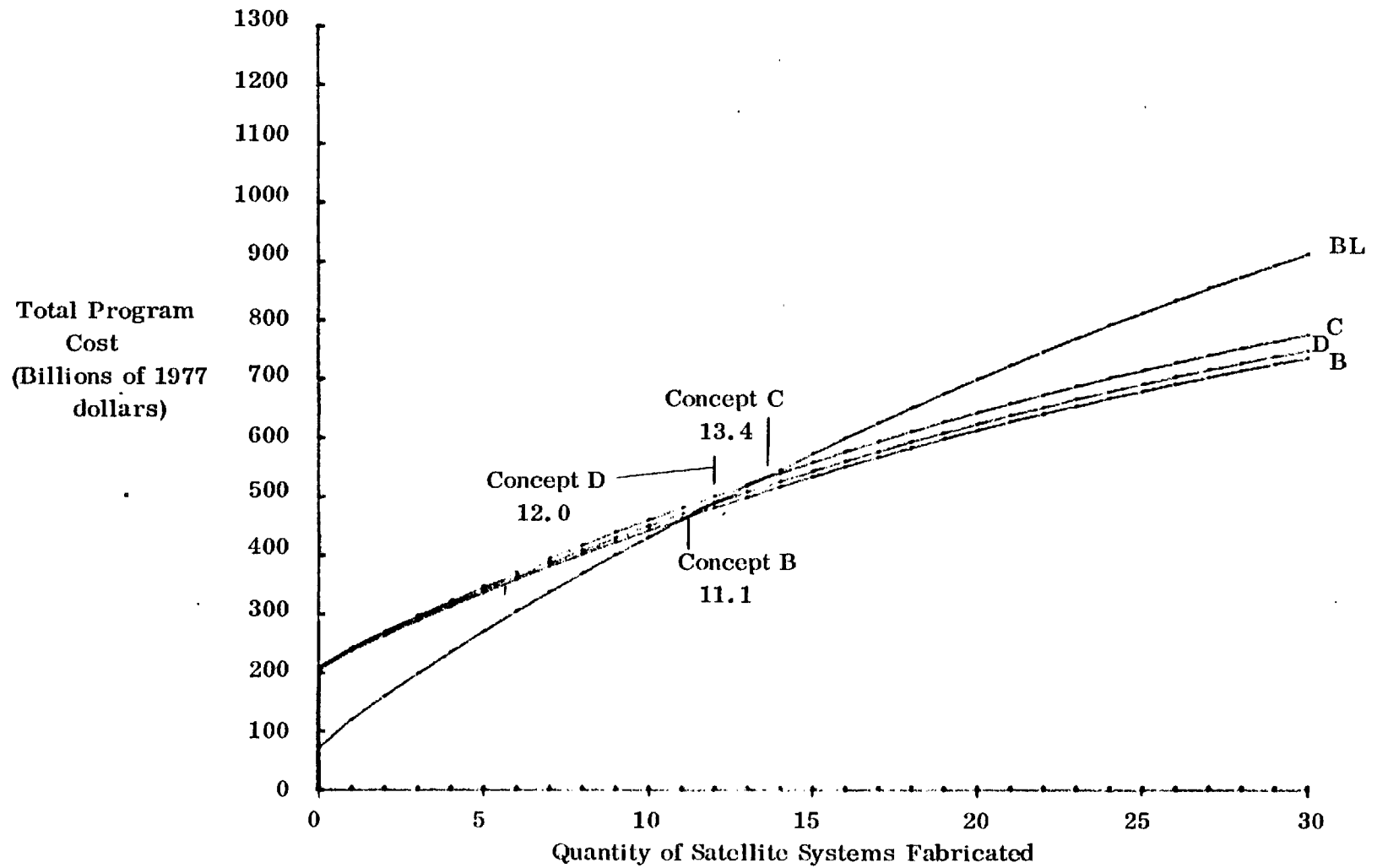

Figure 5-15. Nominal Economic Thresholds if Earth Baseline and LRU Concept Manufacturing Costs are Equal.

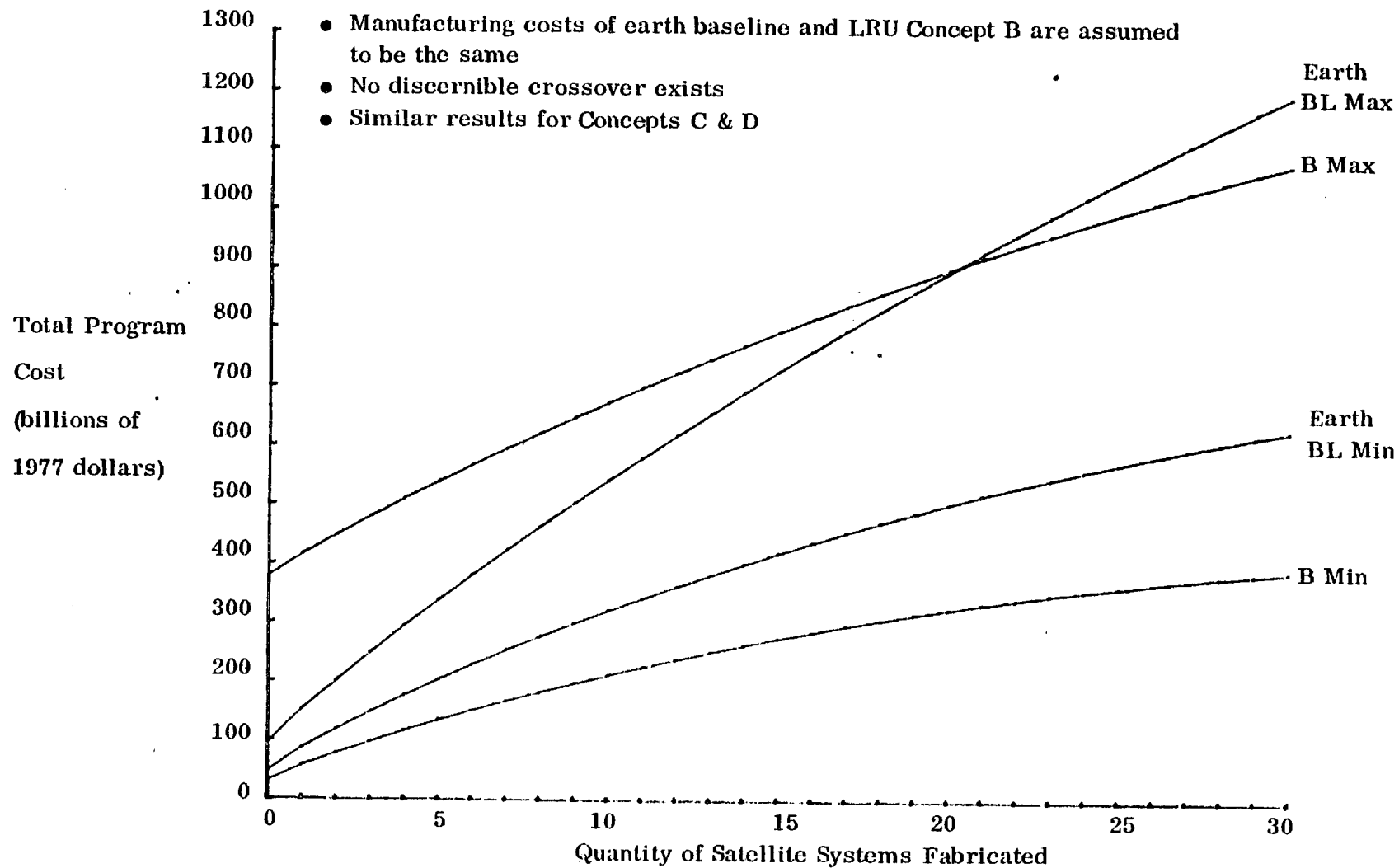

Figure 5-16 . LRU Concept B economic threshold with $\pm 3\sigma$ uncertainty ranges.

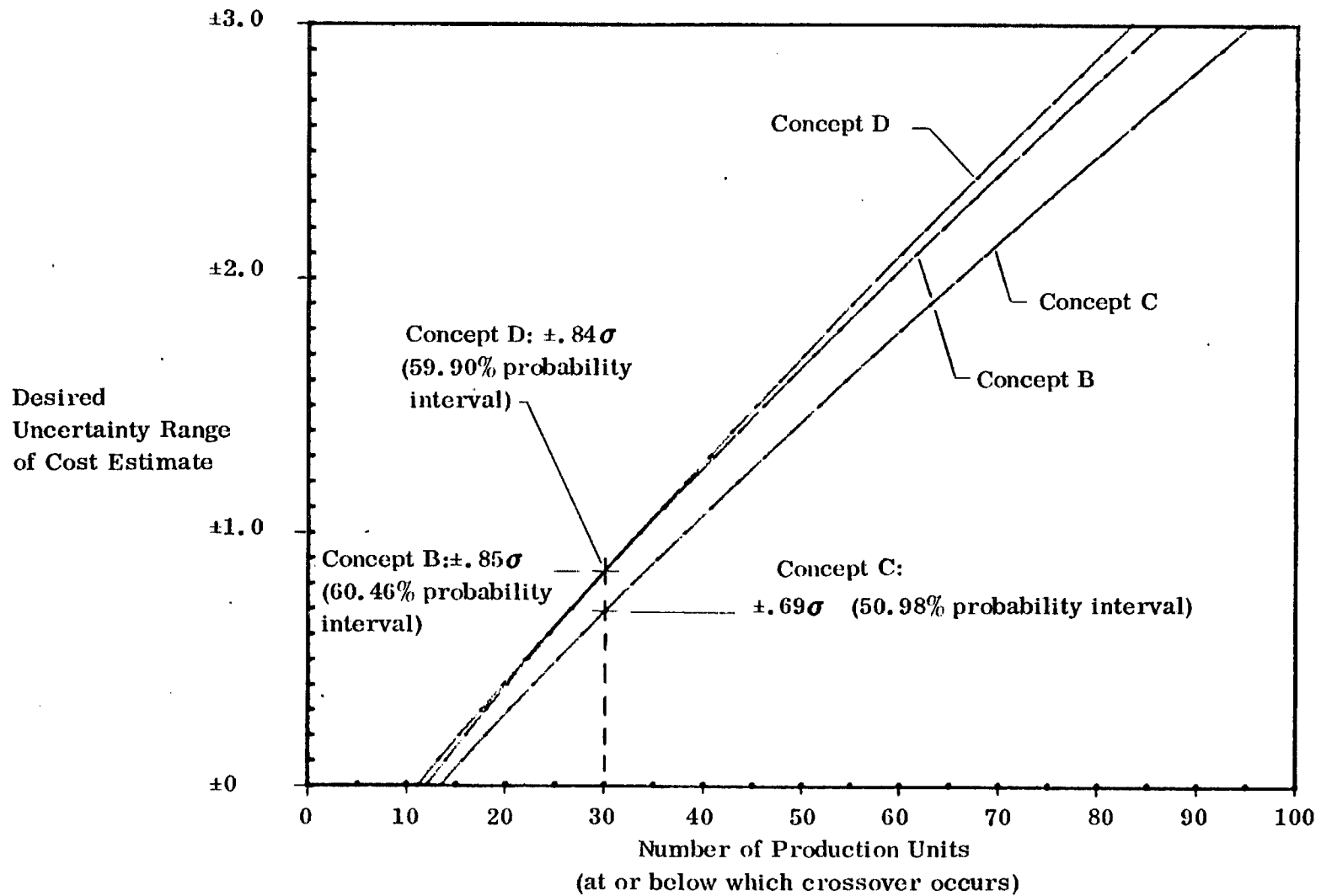
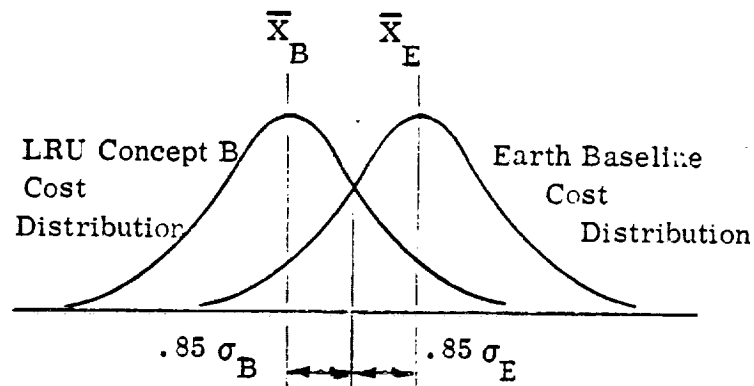

Figure 5-17. Crossover Points if Earth Baseline and LRU Concepts have Equal Manufacturing Costs.

Figure 5-17 is a plot similar to the one done previously in Figure 5-14. It shows the maximum discernible crossover point as a function of the uncertainty range. The required confidence interval to achieve crossover is significantly lower than was previously noted. The narrower bands only include about 60% of possible cost outcomes for each option.

The probability of achieving a crossover at or before 30 units for Concept B is the joint probability of the Earth Baseline being greater than $X_E - .85\sigma_E$ and LRU Concept B being less than $X_B + .85\sigma_B$. This is computed below:



$$\begin{aligned}
 P_1 &= \text{Probability } X_B \leq \bar{X}_B + .85\sigma_B = .8023 \\
 P_2 &= \text{Probability } X_E \geq \bar{X}_E - .85\sigma_E = .8023 \\
 \text{Joint Probability} &= P_1 \cup P_2 \\
 &= (.8023) (.8023) \\
 &= .6437 \text{ or } \underline{\underline{64.37\%}}
 \end{aligned}$$

Thus, it can be stated that for equivalent Earth Baseline and LRU Concept B manufacturing costs, there is a 64.37% probability that a crossover will occur within the 30-unit production run. In a similar fashion, probabilities for Concept C and D were computed to be 56.99% and 63.92%, respectively.

5.4.4 IMPLICATIONS OF THE UNCERTAINTY AND SENSITIVITY ANALYSES.

Probably the major implication of the analyses is that it can be stated with a relatively high level of certainty that an economic threshold will be reached within the 30-unit production run. The sensitivity analysis shows that even if the manufacturing costs of

the LRU concepts are grossly understated, they still appear to be more cost effective than the Earth Baseline on a nominal cost basis.

The uncertainty analysis provided us with a measure of confidence for the cost estimates. Using confidence bands, we are in effect recognizing that it is improbable that the nominal point cost estimate will occur. It is recognized that costs will actually fall within a given range about the nominal. These ranges were defined using standard deviation as a measure of dispersion. The effect of cost uncertainties on the economic threshold is significant. For confidence bands which include 99.7% of possible outcomes, no conclusions can be reached regarding cost effectiveness. The bands are too wide to ascertain a crossover. It was found, however, that with narrower confidence intervals (85-93% probability intervals) that crossovers would occur within the production run of 30 Solar Power Satellites.

The sensitivity analysis, in effect, assumed that the LRU concept manufacturing chains were not vertically integrated and that manufacturing costs were equal to those of the Earth Baseline. This assumption increases LRU manufacturing costs considerably and the corresponding uncertainties.

The probabilities of reaching a crossover at or before 30 units for the two cases above are:

	Different Manufacturing Costs	Same Manufacturing Costs
Concept B	92.79%	64.37%
Concept C	86.34%	56.99%
Concept D	88.47%	63.92%

The probability that the LRU concepts would be more cost effective is reduced considerably if manufacturing costs are assumed the same. Even though reduced, the chances of being more cost effective than the Earth Baseline are still fairly high. These probabilities apply for a production limit of 30 satellites. For higher production numbers the probabilities of crossover increase.

5.4.5 KEY DRIVER PARAMETERS

The LRU and Earth Baseline system elements which have the greatest influence on overall program development costs and production costs are known as key driver parameters. These can be identified from the information generated for the cost uncertainty analysis. Table 5-12 contains nominal and $\pm 3\sigma$ costs for each major system element or group of elements in LRU Concepts B, C and D and the Earth Baseline. Summation of the nominal cost and the $+ 3\sigma$ cost yields the maximum cost contribution of each element. The elements with the largest sums have the greatest potential influence on total program cost and are key cost drivers.

Table 5-13 ranks system elements in order of their potential cost contribution. Ranking 1 corresponds to the highest potential cost element and is followed in descending order by elements which contribute lesser amounts.

For all LRU concepts, the RDT&E key driver parameter is space based facilities and equipment (by a maximum potential cost factor of approximately 2). This is followed by the SPS construction system for LRU Concept B, and lunar based facilities and equipment for Concepts C and D. Cargo Orbital Transfer Vehicle (COTV) and Shuttle Derived Vehicle (SDV) costs are greater contributors than innovative transportation system elements. Elements such as the mass driver/mass catcher and lunar derived rocket (LDR) have high cost uncertainties but relatively low nominal development costs, so their overall influence on total RDT&E uncertainty range is small. It is interesting to note that the influence of SPS hardware development costs on total RDT&E is also small compared to space facilities and major transportation vehicles.

RDT&E key driver parameters for the Earth Baseline are earth based facilities and equipment, the SPS space construction system, and Heavy Lift Launch Vehicle (HLLV), followed by satellite hardware and the remaining transportation vehicles.

The first three key driver parameters for production are the same for the Earth Baseline and all three LRU concepts. Earth based production of satellite hardware plus its delivery into orbit contribute potential costs an order of magnitude greater than other production elements.

To reduce cost uncertainties associated with lunar resources utilization, efforts should be focused on production ranking 1 (earth produced satellite hardware), RDT&E ranking 1 (space facilities and equipment development production ranking 2 (earth based transportation), RDT&E ranking 2, production 3, RDT&E 3, production 4, followed by RDT&E rankings 4, 5 and 6 in that order.

Table 5-13. Ranking of Cost Contributors.

Nom + 3 σ Ranking	LRU Concept B	LRU Concept C	LRU Concept D	Earth Baseline
RDT&E				
1	Space facilities	Space facilities	Space facilities	Earth facilities
2	Construction sys	Lunar facilities	Lunar facilities	Construction sys
3	COTV	COTV	Construction sys	HLLV
4	SDV	Construction sys	Facility activation	SPS hardware
5	Facility activation	Facility activation	COTV	COTV
6	Lunar facilities	SDV	SDV	PLV
7	SPS hardware	SPS hardware	LDR	POTV
8	Mass driver & mass catcher	Earth facilities	SPS hardware	—
Production				
1	EB SPS hdwre	EB SPS hdwre	EB SPS hdwre	EB SPS hdwre
2	EB transportation	EB transportation	EB transportation	EB transportation
3	SB facilities	SB facilities	SB facilities	SB facilities
4	SB transportation	SB transportation	LB facilities	EB launch ops
5	SB construction	LB facilities	SB transportation	—
6	LB facilities	SB construction	SB construction	—
7	EB launch ops	LB construction	LB transportation	—
8	LB transportation	LB transportation	LB construction	—
	EB - Earth based	LB - Lunar based	SB - Space based	

5.5 FUNDING SPREAD PROFILES/PRESENT VALUE ANALYSIS

The determination of total program cost is only the first step in the determination of the economic viability of a given program. The timing of the required funding to support that program is also an important consideration in program selection. If 90 percent of the funds of a 10 billion dollar program were required within two months of the start of that program, the selection of that particular program may be questionable. At the other extreme, if only 10 percent of the funds were required over the next 30 years and the remaining 90 percent were required for the following 20 year period the program would probably be more desirable. The previous two statements point out the importance of the timing of the cash outflows in program selection. Low early year funding tends to be more desirable than high early year funding. Constant annual funding may also be a better alternative than high early year funding. The primary reason for these criteria is probably that funding is limited in a given year by the available NASA budget.

A major underlying facet of the timing of cash flows, which can have a significant effect on the selection of an alternative program, is the time value of money. In the private sector a discount analysis is one of the primary considerations in a capital budgeting analysis. In this analysis, future cash inflows and outflows are estimated over the life of each investment project. Alternative projects can then be evaluated by selecting the one with the highest (1) internal rate of return or (2) net present value, given a required rate of return on investment. The basis of the discount analysis is that money has a time value. Given a limited amount of investment funds, the firm seeks projects which maximize this return on investment.

It is becoming more common in the government sector to perform discount analyses in project selection. Like the private sector, the government is also faced with budget ceilings. Once the decision has been made that a project or service is a socially

desirable expenditure, the government must select only the most cost effective alternatives in reaching its goals. In the case of the government sector, there are generally no revenues resulting from the investment so the return is measured by a negative net present value, or the present value of total program cost. The lower the present value of a project alternative, the more desirable that alternative is.

Implicit in the government sector discount analysis is the understanding that since there are no investment revenues, costs are covered through taxation of the private sector. Thus, it must be determined what resources society is willing to sacrifice in order to obtain the added government service. That sacrifice is generally expressed as the required social rate of return, or that rate of return which could be achieved by the private sector if it provided the same service. If government cannot achieve this return, society as a whole would be better off if the service were provided by the private sector. This reduces taxes and the private sector uses those funds for viable investments. Thus the appropriate discount rate to be used in NASA type programs is the return which could be earned by private aerospace firms through private investment. This return is generally accepted as 10 percent, although it can vary somewhat.

A present value analysis then, assures the efficient allocation of resources, whether in the private sector or the government sector. It is a useful tool for use in the selection of alternative investments because it considers not only the magnitude of the program costs but also the timing of expenditures and the time value of money. It also provides insight into the desirability of alternative funding spread options by providing a means to numerically quantify various funding curve shapes. In effect, the present value analysis removes the time variable, so projects are compared on an equivalent basis.

The following sections provide more detailed descriptions of how funding spreads and present values were derived. The results of the analyses are also provided.

5. 5. 1 Funding Profiles

The importance of the funding profile in program or concept selection was stressed in the preceding section. A funding spread analysis is often an iterative process where it is used to establish a program schedule that will comply with funding limitations. Expenditure profiles for a planned program can be revised by shifting the schedule of planned events until the program plan satisfies funding, as well as time constraints. The resulting funding profiles can readily be used for a discount analysis if that step is required. The analysis of funding requirements then, is an important tool, both in the formation and selection of a space system program.

There are three types of funding spread profiles which will cover the planned expenditure patterns in the LRU Study Programs. These are the Beta, rectangular and triangular distributions, shown in Figure 5-18. The Beta distribution allows for variations in expenditures over the life of the project, the rectangular distribution provides a constant annual cost for the project and the triangular distribution allows for constant annual increasing costs. The distributions are merely mathematical formulations used to simulate the expected expenditure profiles. The selection of the distribution to use is dependent upon the cost element in question. Since development activities generally require varying levels of funding, the Beta distribution is more appropriate for RDT&E. Funding levels for production could be represented by either distribution. If the production rate is constant, funding levels would also be constant, and a rectangular distribution could be used. Varying production rates would dictate the use of a Beta distribution. In the operations phase the triangular distribution is more appropriate since annual operating costs increase at a fairly constant rate, due to the addition of a new satellite each year.

Funding spreads may be made at any selected cost work breakdown level and summed upward to obtain totals for the RDT&E, Production and Operations phases as well as for Total Program Cost. Due to the many possible spreads which may be required

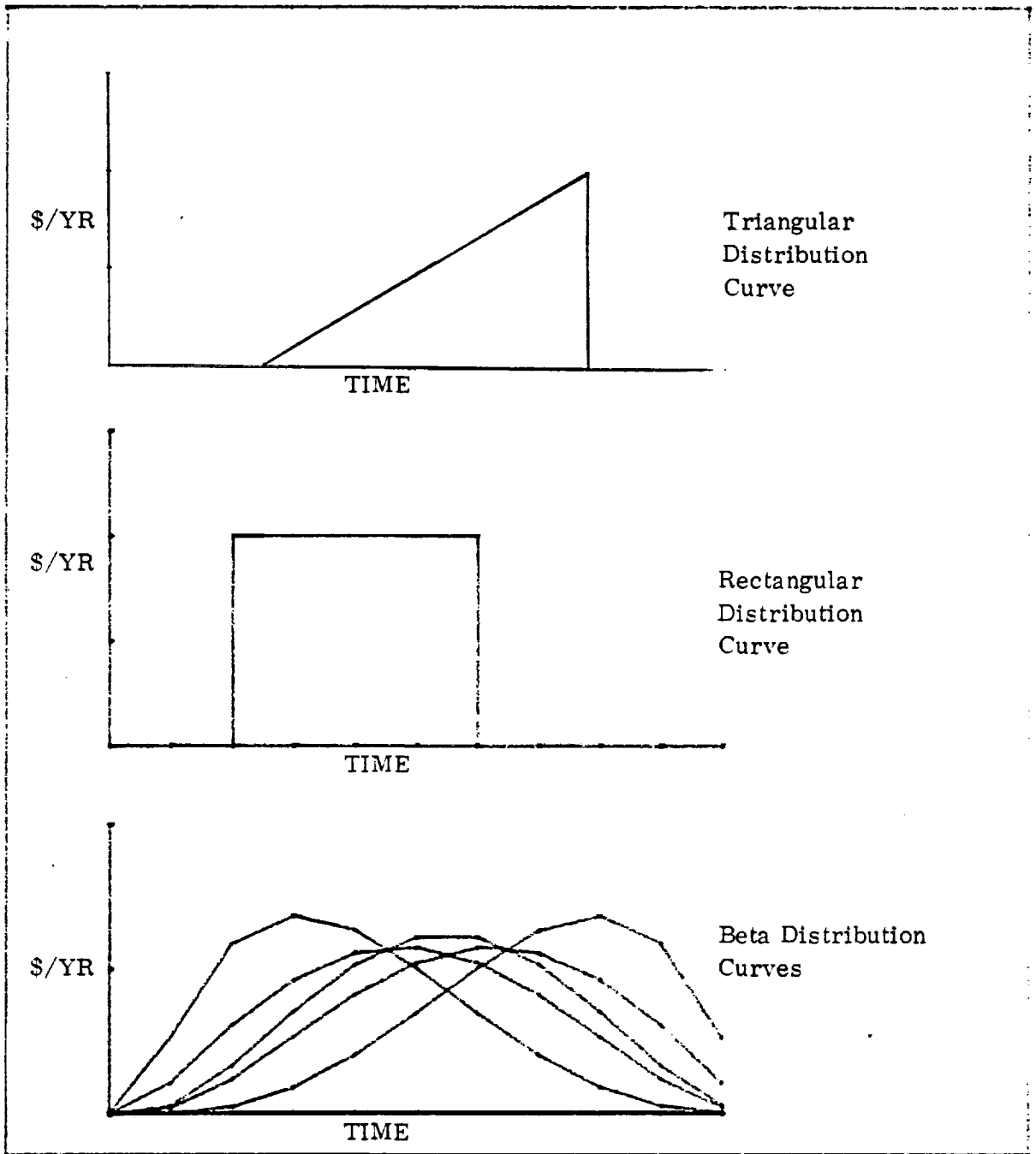

Figure 5-18. Annual Cost Distribution Curves

for each program the funding spread equations were adapted for use on the Hewlett Packard 9810 Computer/Plotter. The computer not only makes quick, accurate computations, it also keeps track of the time phasing of the various funding spreads much easier than if it were done by hand and provides a plotting capability.

The schedules shown in Figures 5-19 and 5-20 were constructed using Figures 6-2 and 6-3 as a guide. The schedules show the time spans of various major cost activities and indicate the WBS level where individual funding spreads were made. Due to the lack of detailed definition at this point in time, the schedules for the three LRU options were assumed to be the same. The type of funding spread assumed for each cost element is also provided in the figures.

Using the schedule time spans and the element costs, funding spreads were determined on an annual basis for each alternative program. These results are shown in Figures 5-21, 5-22, 5-23 and 5-24. An attempt was made to provide lower early year funding with a gradual buildup in requirements as each program progresses. An attempt was also made to provide fairly constant annual requirements in the steady state production condition, although this effort wasn't completely successful. Each curve shown represents one of the major cost elements shown in Figures 5-19 and 5-20 and are labeled accordingly.

The expenditure profiles are indicative of the relative costs of the alternatives. Annual costs are highest for the Earth Baseline (Reference Figure 5-20) peaking at \$25.58 billion in the year 2004. Annual costs for the LRU options are in the order of \$15 billion per year beginning in about 1990. Based on the lower annual funding requirements of the LRU concepts, the LRU concepts appear to be much better alternatives than the Earth Baseline. The annual costs of any one of the programs, in light of the present NASA budget, appear excessive and shed doubts on the capability of a single enterprise to

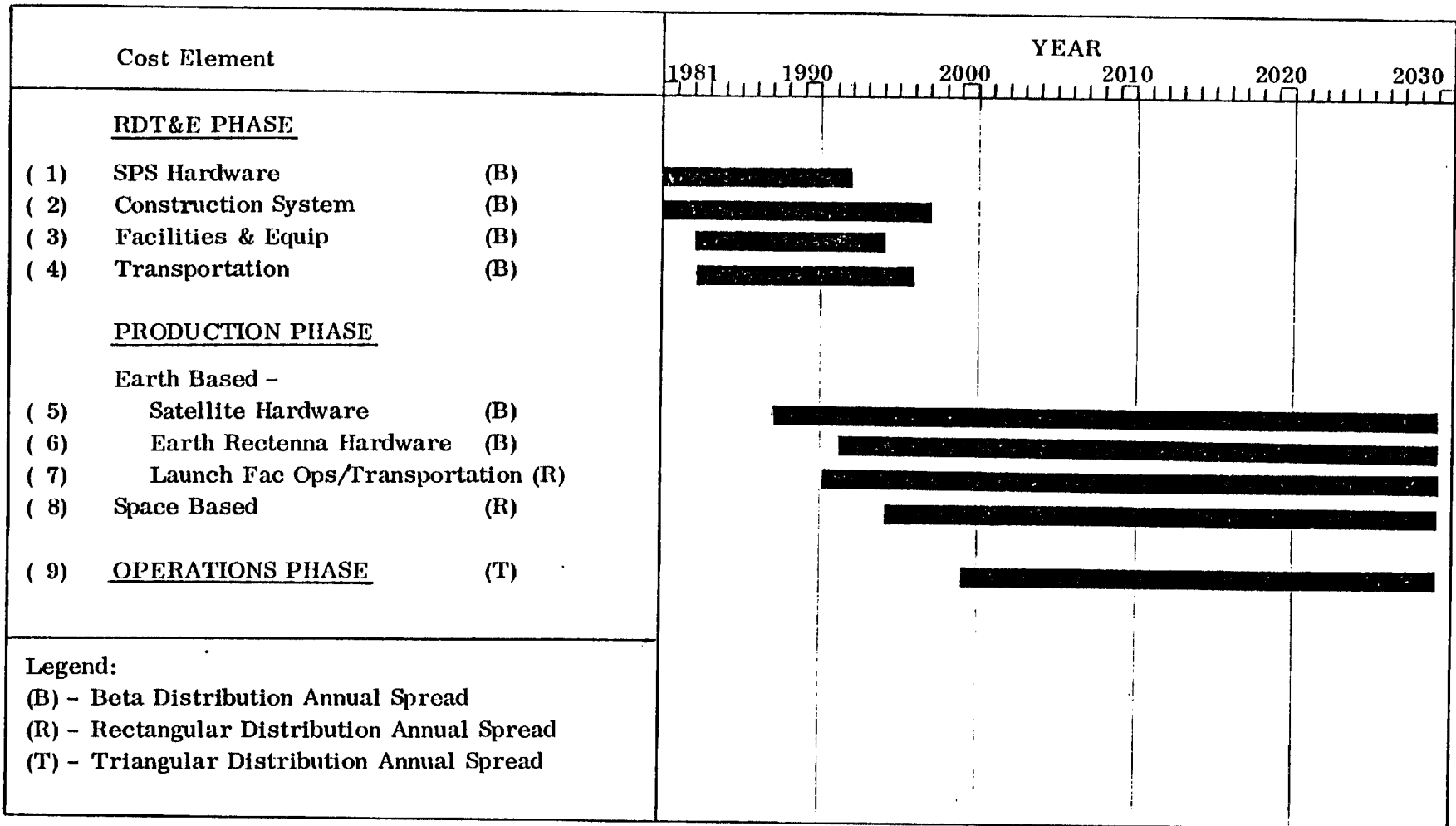

5-72

Figure 5-19. Earth Baseline Funding Spread Schedule.

5-73

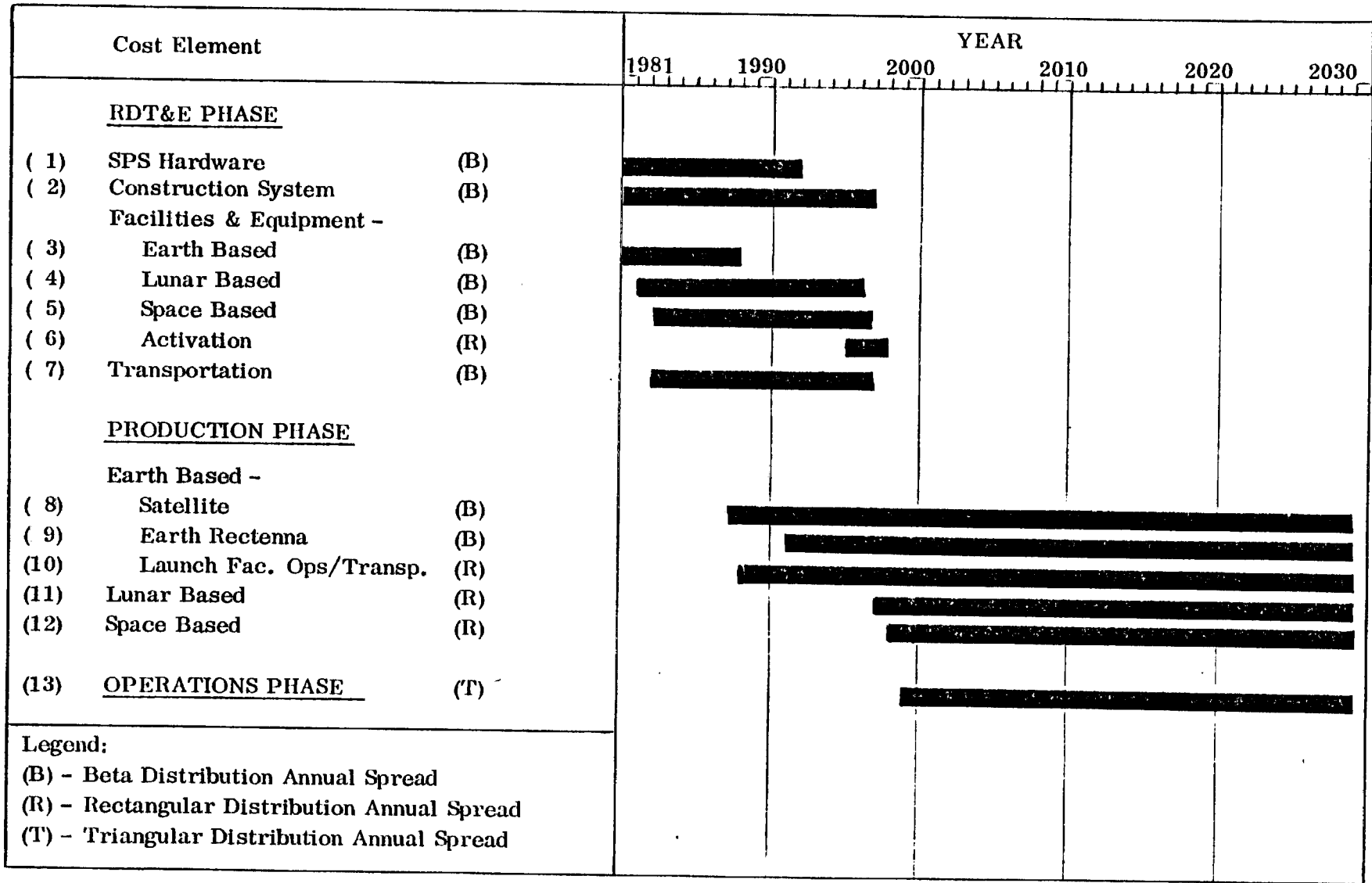

Figure 5-20 Funding Schedule - Typical for LRU Concepts B, C & D.

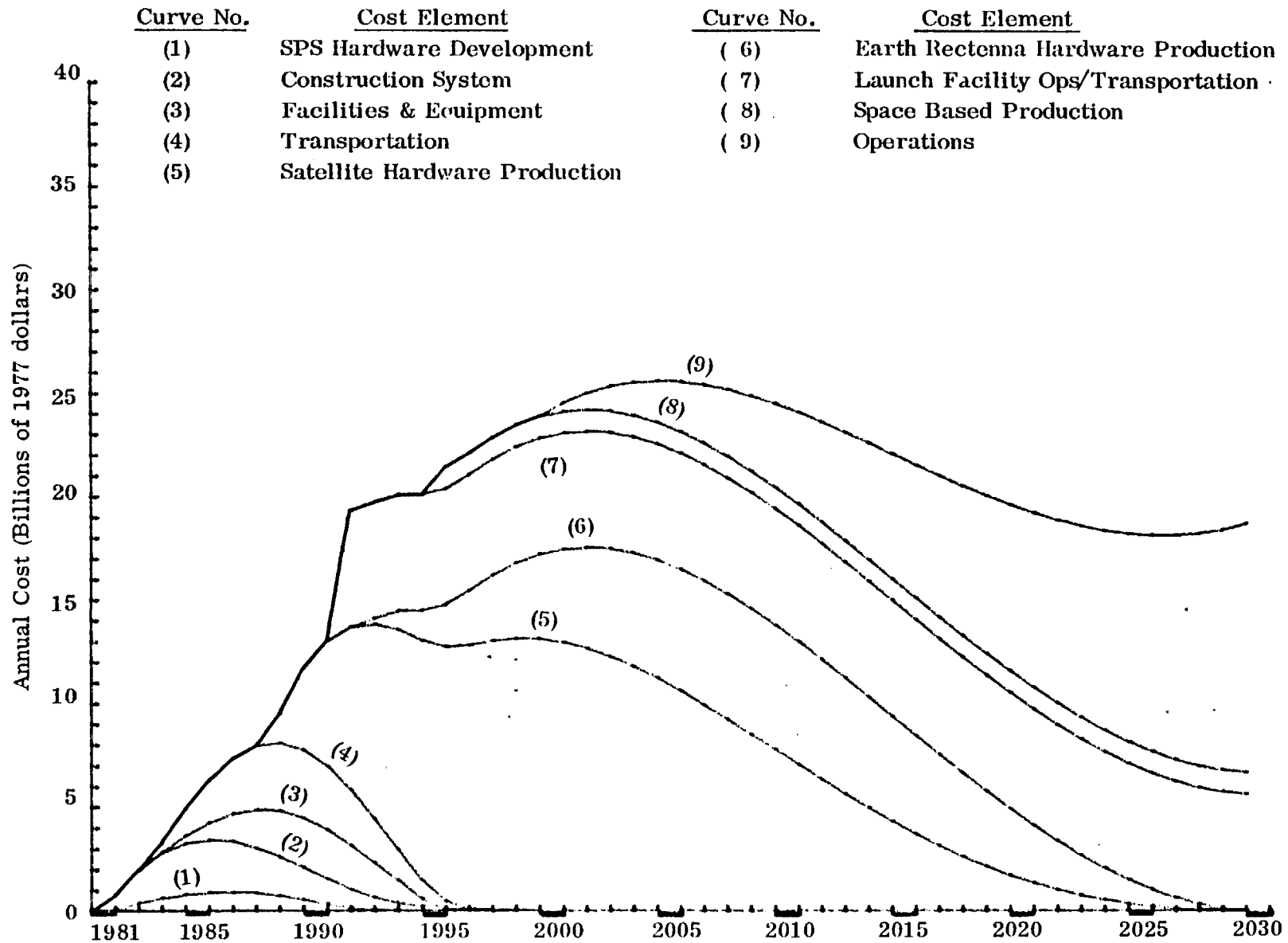

Figure 5-21. Estimated Annual Expenditures - Earth Baseline.

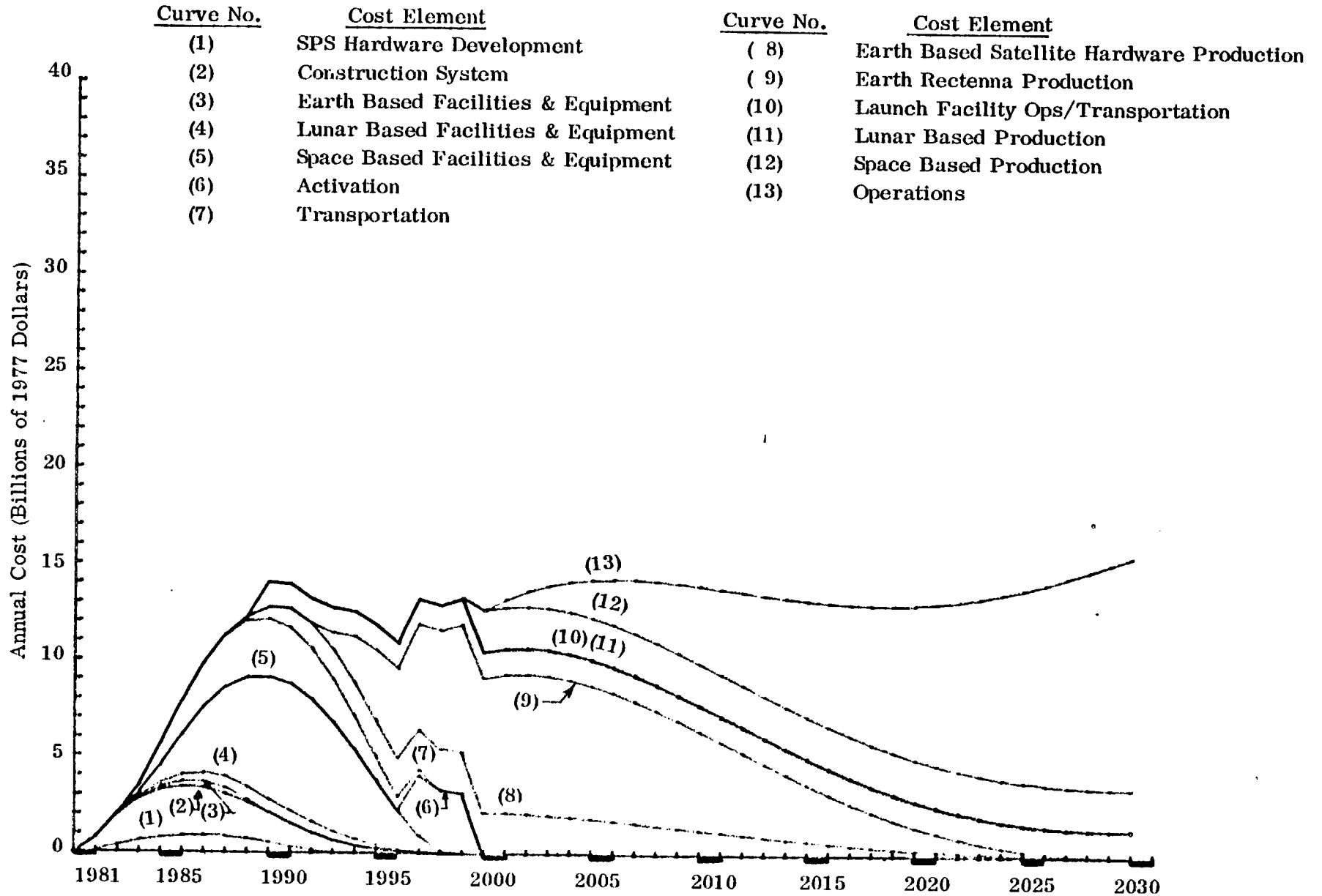

Figure 5-22. Estimated Annual Expenditures - LRU Concept B.

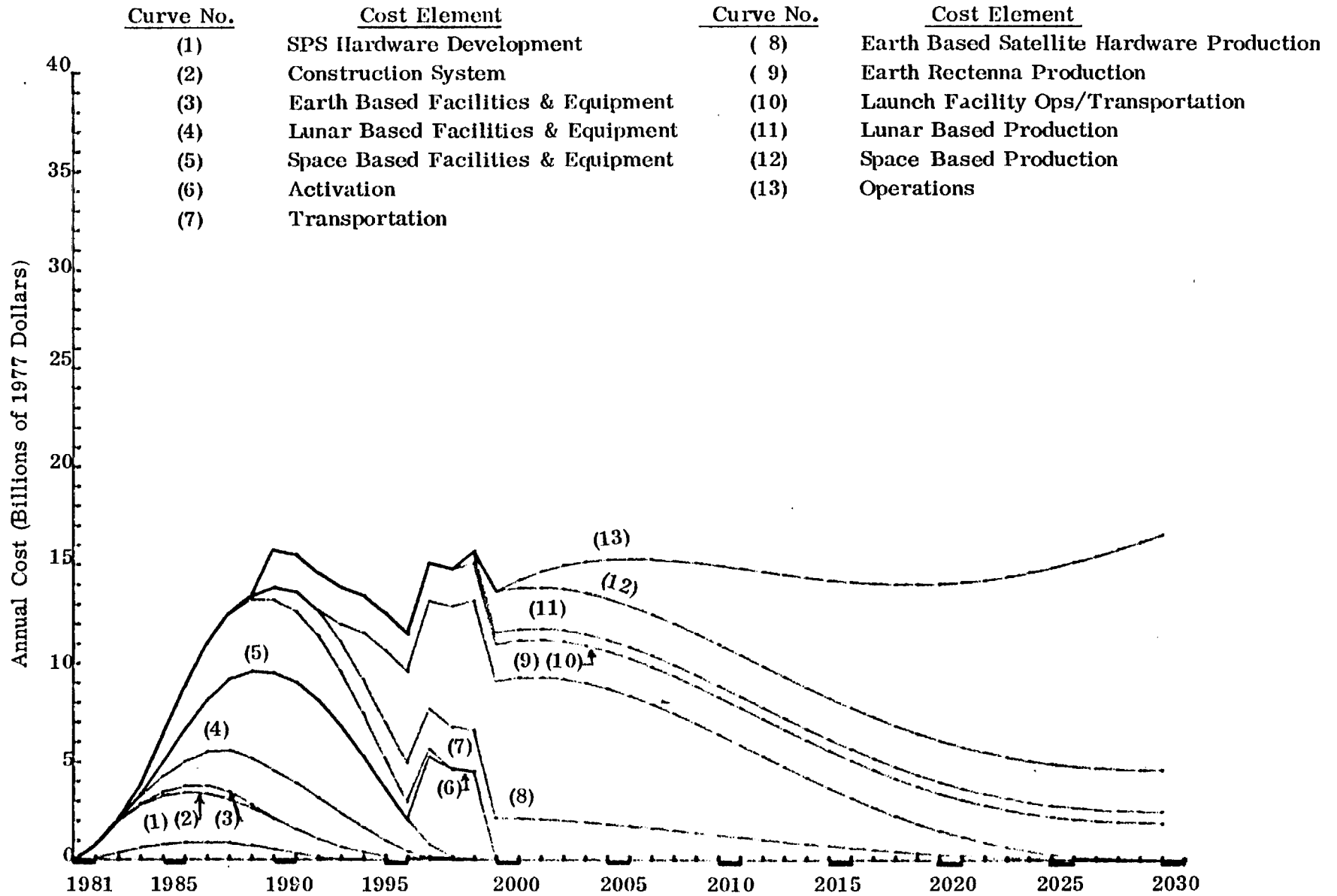

Figure 5-23. Estimated Annual Expenditures - LRU Concept C

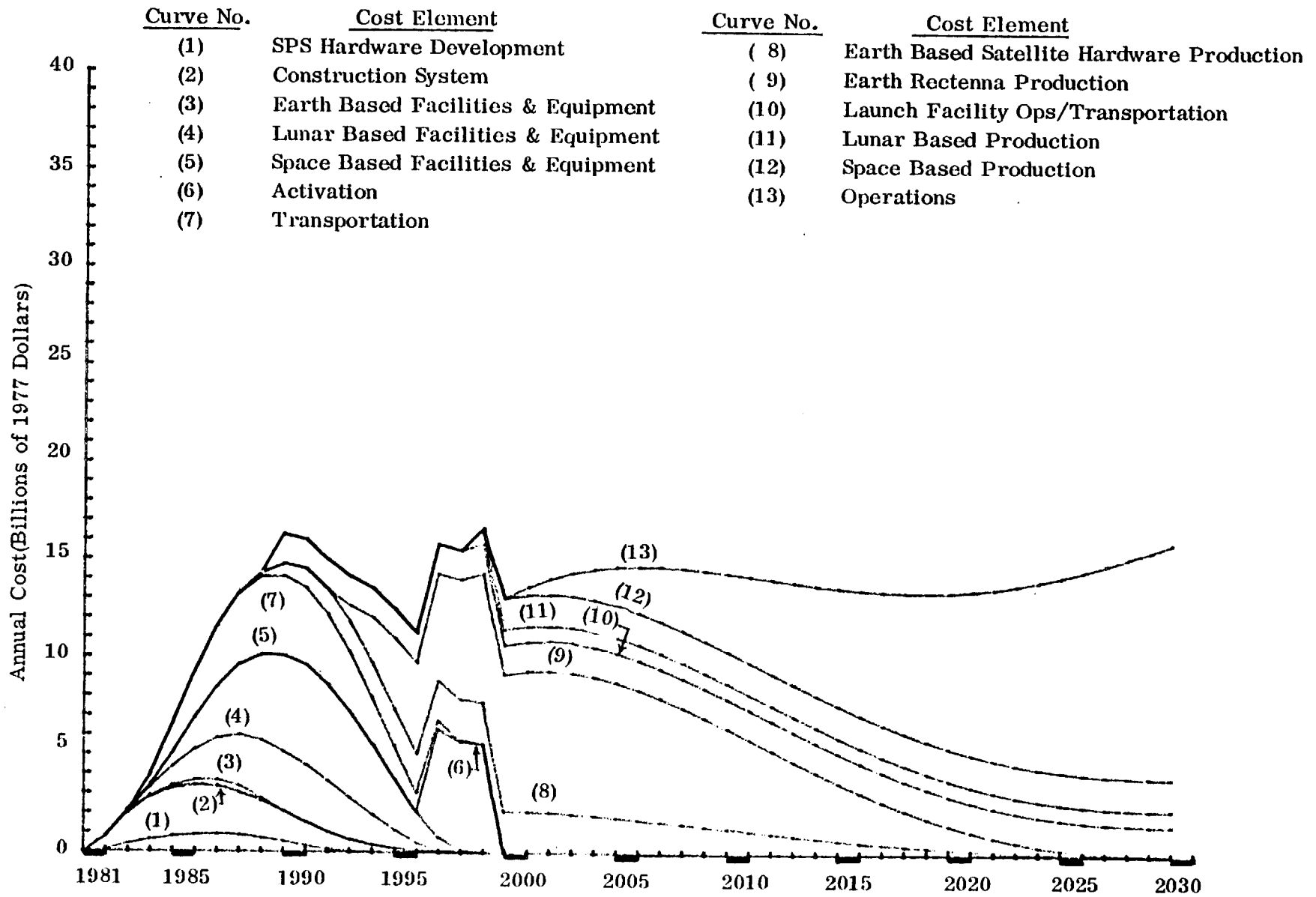

Figure 5-24. Estimated Annual Expenditures - LRU Concept D.

undertake such a program. For a program of this magnitude, some sort of consortium would probably have to be formed in order to provide the required funding.

5.5.2 Present Value

As was mentioned earlier, the present value analysis is a useful economic tool which permits direct comparisons of alternative investment projects from the standpoint of cost, expenditure timing and the time value of money. It is merely a means of providing additional insight into the economic viability of each alternative and is by no means the single deciding factor on project selection. Total costs allow the determination of the program which is lower in cost, but fail to tell us when the money will be spent. Funding spreads, tell us the timing of required expenditures but do not include the time value of money. The present value analysis includes all three facets. The output of the analysis is the cost of each alternative program in discounted dollars. In simplistic terms the analysis answers the question, "how much money would have to be put in a bank savings account right now to finance the entire program per the funding schedule, given the money earns compound interest?" The use of discounted dollars then, puts the alternatives on an equal basis for comparison. The value of the entire program is expressed at one point in time.

The appropriate discount rate to use in determining present values is in the order of 10 percent. To allow for the uncertainty in the rate, three rates were actually chosen for the present study: 7%, 10% and 15%. Discounted dollars were determined using each of the three rates and the results are shown in Figures 5-25, 5-26 and 5-27. The present value is plotted on a cumulative basis by year through program end for each of the program alternatives. This was done to show at what point in the overall program that the LRU present values become lower than the Earth Baseline. It should be kept in mind that the primary criteria is the total present value, or that point

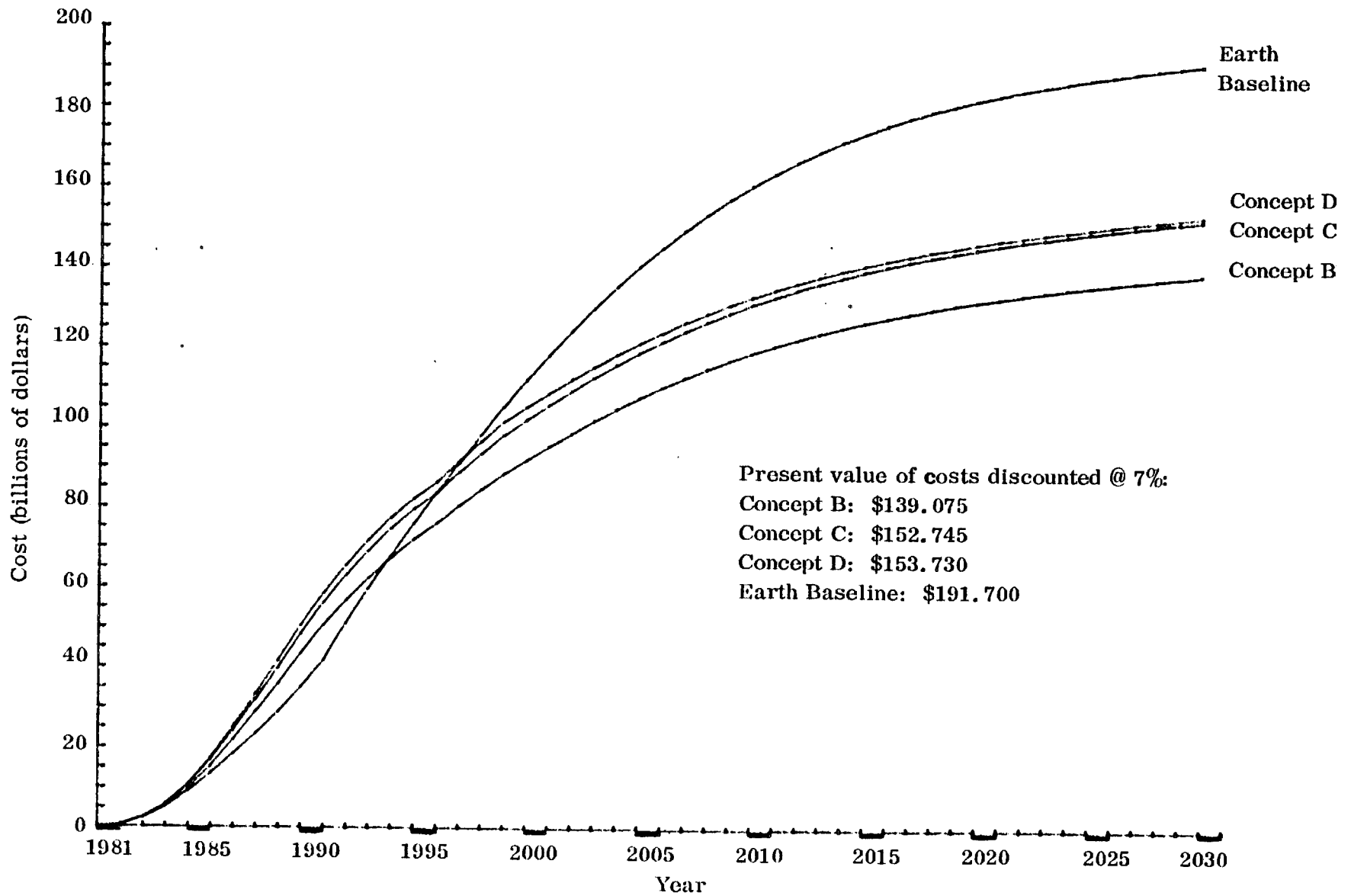

Figure 5-25. Cumulative Present Value Comparison of Costs at a 7% Discount Rate.

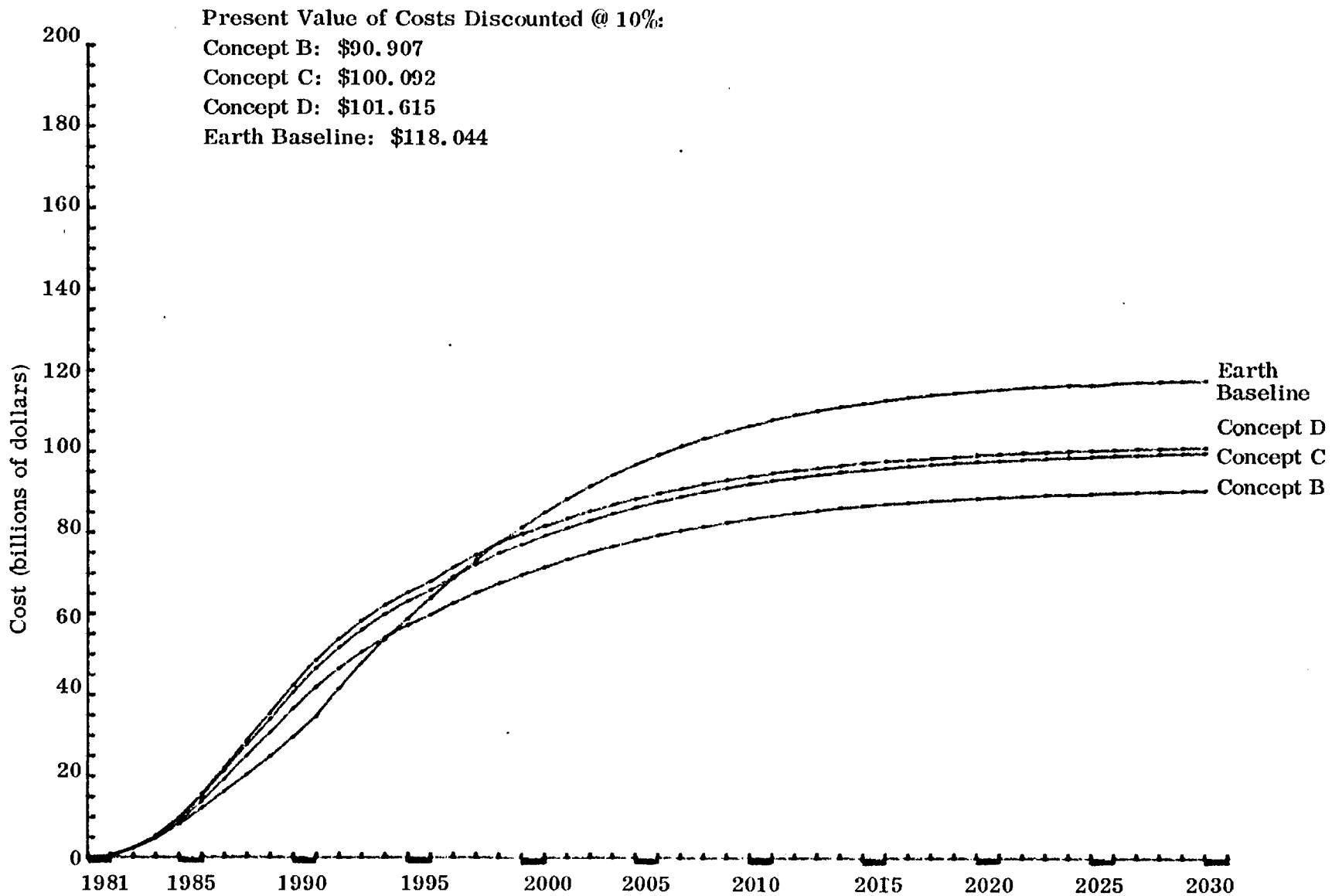

Figure 5-26. Cumulative Present Value Comparison of Costs at a 10% Discount Rate.

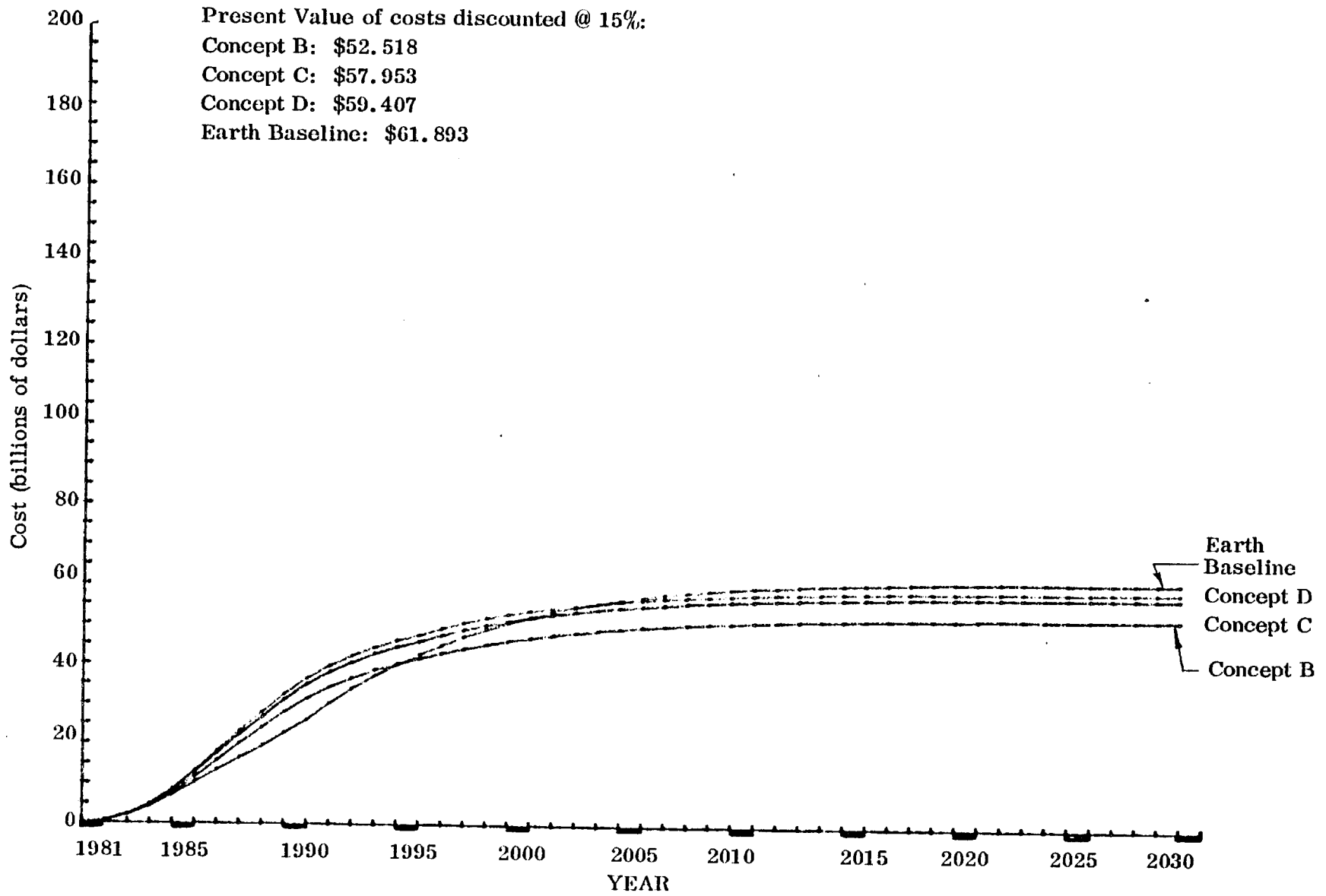

Figure 5-27. Cumulative Present Value Comparison of Costs at a 15% Discount Rate.

on the far right hand side of each curve. The intermediate points only serve to provide a relative ranking if the program funding were cut off for some reason before the end of the originally planned program life.

The three sets of curves show the same relative rankings of the alternatives. LRU Concept B has the lowest present value, followed by Concept C, Concept D and then the Earth Baseline. This ranking supports the earlier analysis based on the nominal total cost. It indicates that all the LRU alternatives are superior to the Earth Baseline. The present values shown in Figures 5-25 through 5-27 were based on the nominal cost. The same approach could be applied to the $\pm 3\sigma$ costs established earlier in order to determine the effects of cost uncertainty on the present value analysis. A summary of results is contained in Table 5-14.

Table 5-14. Present Values of the Alternatives.
(billions of 1977 dollars)

Billions of Dollars	Present Value Of Costs Discounted At		
	7%	10%	15%
Earth Baseline	191.7	118.0	61.9
LRU Concept B	139.1	90.9	52.5
LRU Concept C	152.8	100.1	58.0
LRU Concept D	153.7	101.6	59.4

6

PRELIMINARY DECISION ANALYSIS (TASK 5.5)

TASK — For the programs in which lunar utilization appears both economically and technically feasible, determine the economic and schedule achievements which would justify decisions to expend funds for implementing each of the several steps in an evolutionary lunar utilization program.

APPROACH — Perform an assessment of how best to proceed with LRU should a suitably large space production program be authorized. The basic premise is that use of lunar resources should be maintained as a viable construction option through the early phases of program development until sufficient information becomes available to support a decision concerning its suitability and economic effectiveness.

A program to utilize lunar materials for construction of large space systems must proceed through implementation steps which relate to and parallel the development and demonstration of the end product. The results of the LRU study obtained to date have indicated that an ambitious space program is required before utilization of lunar resources becomes economically feasible. Prior to embarking on a program of this magnitude, a substantial satellite development effort would be required which is relatively independent of the final location selected for material resources acquisition.

The initial output of this task is to define suitable interaction between an earth baseline construction program and a LRU optional program for construction of similar large space systems. This has been accomplished by assuming that any space program large enough to justify LRU consideration would require an earth-based "proof-of-concept phase" including prototype demonstration, prior to committing to full-scale production. During this "proof-of-concept" program activity associated with the proposed product, parallel efforts can evaluate and demonstrate the effectiveness of lunar resource

utilization. The identification of these parallel programs, their interaction, and key decision points is contained in the following subsection. Subsequent work generates development schedules for these parallel programs. The economic and schedule achievements needed at the completion of each program phase to continue with an evolutionary lunar resource utilization program are then evaluated.

6.1 PARALLEL DEVELOPMENT PROGRAM DEFINITION

An end product development and demonstration program will go through at least five major phases prior to the actual production of the operational space system.

1. The conceptual design of the product and its required manufacturing facilities and support systems.
2. Tests conducted on earth to develop and demonstrate the basic technologies necessary for the program to perform as specified.
3. A second-generation of technology demonstrations conducted in space to verify successful performance of critical components and subsystems.
4. Development of the capability to perform a space system demonstration as proof of concept. This phase culminates in operation of the demonstration system.
5. Implementation of those space facilities and support elements needed to initiate production of full-scale satellite systems.

These five end product development phases are summarized by the following block diagram describing the program flow.



Discrete steps in the development of lunar resource utilization can be accomplished in parallel with these end product development phases. These parallel paths are interconnected by natural decision points which require comparative reassessment of progress and continuing viability of the LRU option. A presentation of these parallel program paths is shown in Figure 6-1.

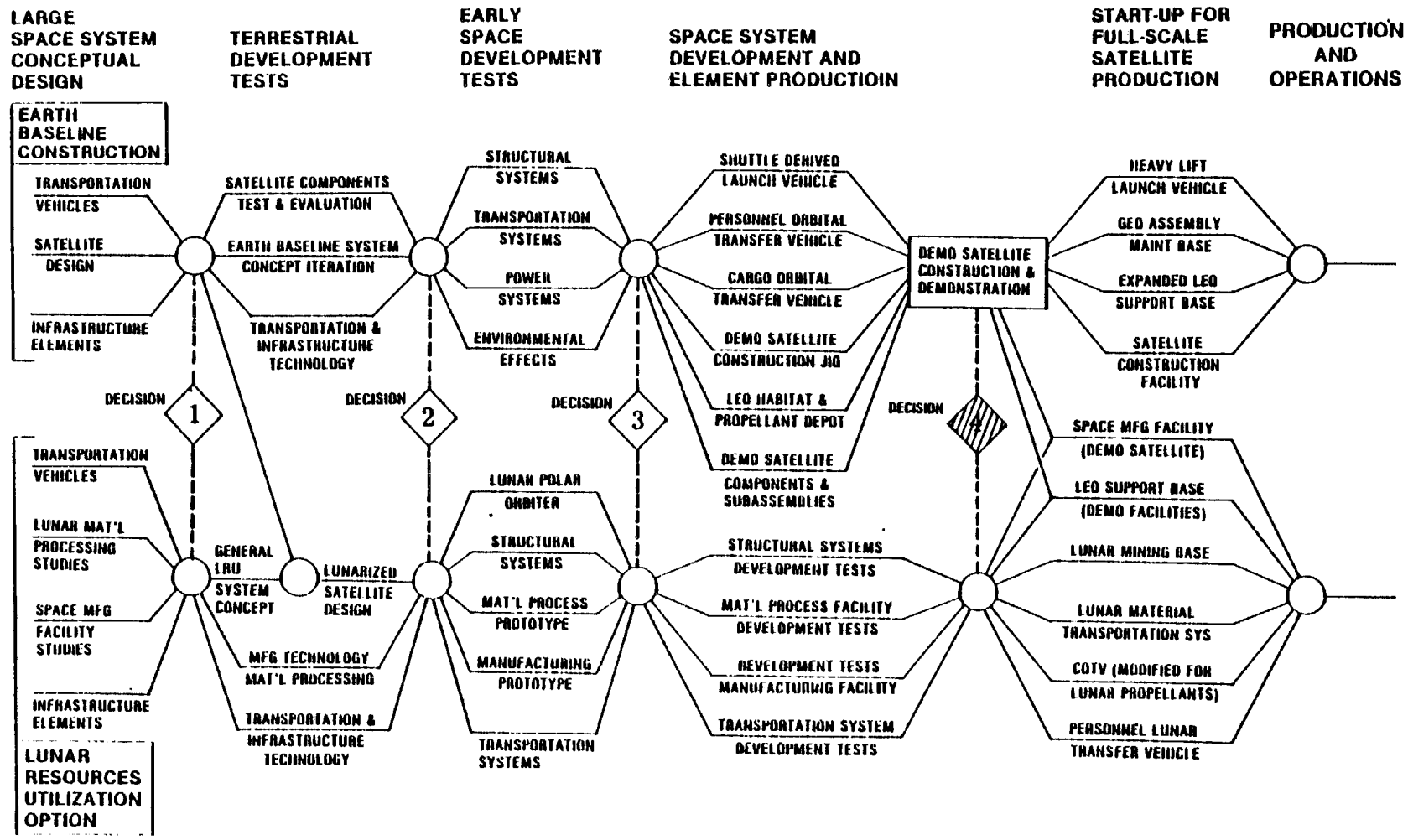
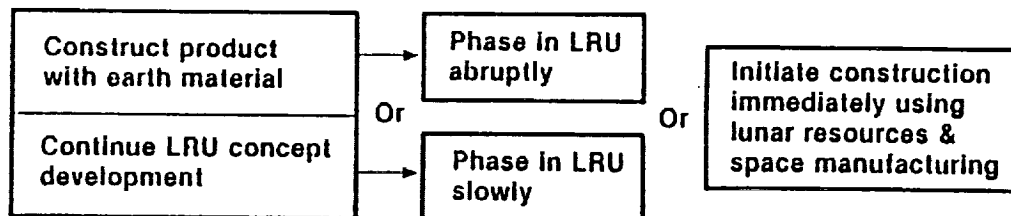

Figure 6-1. Parallel Development Programs for Earth Baseline and LRU Satellite Construction.

6-3

Several preliminary observations regarding Figure 6-1 should be made: (1) the earth baseline path and LRU path appear to be independent, but in fact offer many opportunities for interaction and cross influence as development progresses. For example, if LRU technology demonstrations prove successful, this should influence the design and construction of the demonstration satellite toward LRU material compatibility. (2) Most of the systems produced to support construction of the demonstration satellite, plus the demonstration satellite itself should be suitable for application to the LRU program. Thus, a key decision point occurs at demo satellite operation — a choice between the earth baseline and LRU construction options could logically be made at this point. If LRU is selected, rapid startup of lunar and space manufacturing facilities will be required to maintain program momentum.

As an alternative, lunar resource utilization for satellite construction could be delayed while lunar material compatible satellites are constructed with earth resources. This allows earth-based production and operation of the product while the additional facilities needed for LRU are developed and started up on a more leisurely schedule. These implementation options are highlighted by the following block diagram.



Interaction between the parallel programs shown in Figure 6-1 is discussed in the following paragraphs.

1. Large Space System Conceptual Design Phase

Baseline activities concentrate on defining the end product satellite and support elements (launch vehicles, habitats, and construction fixtures) needed to construct the satellite. LRU option work primarily involves assessment of how baseline support elements can be adapted or utilized as-is to conduct the optional program. In addition, conceptual definition of unique LRU elements such as lunar mining, lunar material transport,

and space manufacturing is accomplished. Interaction is primarily involved with achieving maximum compatibility with transportation vehicles and infrastructure elements for the two parallel programs.

The interim decision point following this phase involves a "continue" or "discontinue" option for the LRU path. Discontinuation would be based on very unfavorable economic analysis study results or a grossly inadequate level of technology readiness.

2. Terrestrial Development Testing Phase

These initial development tests are performed on earth to demonstrate technology readiness for both the earth baseline and LRU programs. Interaction is primarily concerned with the effects of construction material origin (earth or moon) on the satellite design. Hopefully, a compromise satellite design will evolve which is compatible with lunar resource limitations. A compatible design might also permit expanded space processing of earth construction materials, which could improve (increase) earth-launched payload densities for the baseline satellite.

An interim decision point after this phase also provides a "continue LRU program" option if test results and other progress so warrant.

3. Early Space Development Testing Phase

Certain technology demonstrations, especially those at the subsystem level, can best be performed in the system's natural operating environment. These tests are all launched with the Space Shuttle, and will provide practical experience with new hardware under realistic operational conditions. Earth baseline and LRU option development tests are relatively independent of each other and little, if any, interaction is required. Earth baseline program tests are product satellite and transportation system oriented, with special emphasis on the environmental effects of satellite operation and launch vehicle exhaust products. LRU program Shuttle-launched tests are primarily associated with lunar material processing and manufacturing prototype equipment development.

Simulated lunar material obtained from earth will be used for these tests. Special transportation and satellite tests will also be performed for unique lunar material applications. An example of a unique LRU application involves COTV thruster testing. For the earth baseline, argon propellant will be utilized and thruster tests will be accomplished using this propellant. The LRU COTV will utilize oxygen which can be obtained from the moon, rather than argon. Tests to evaluate thruster performance and redesign for oxygen must be conducted as part of the LRU option path. A special LRU activity which occurs during this phase is the launch of a lunar polar orbiter resources mapping satellite. Sensors on this satellite will scan the entire lunar surface to determine if concentrated deposits of useful materials exist. This data will be relayed to earth and evaluated to determine the optimal location for a lunar base.

Another interim "continue LRU program/discontinue LRU program" decision point follows the early space development testing phase.

4. Space System Development and Element Production Phase

During this phase the purpose and emphasis of the two parallel programs differ considerably. The LRU option development tests comprise a second-generation test series to those performed in the preceding phase. The earth baseline construction program, however, develops and constructs those system elements required to build a demonstration satellite. These system elements include transportation vehicles, habitats, and demonstration satellite construction facilities. The demonstration satellite should be of sufficient size to provide useful earth services and will probably require development of a Shuttle-derived vehicle with increased payload capacity. Interaction between parallel program paths is especially important during this phase for two reasons: (a) the demonstration satellite should reflect construction features of both the earth baseline and lunarized satellite design configuration. This may be implemented with a compromise design, or by incorporation several alternative designs in different satellite sections. (b) If the LRU option is subsequently selected, the

demonstration satellite and its support elements will be used as integral parts of LRU manufacturing facilities. Extensive planning will be required to build in compatible features needed for this integration.

Following the successful construction and operation of the demonstration satellite, a key decision point is reached. Some possible alternative decisions include:

- Cancel the entire program (most likely if the demonstration results in unsuccessful satellite operation).
- Discontinue work on the lunar resources utilization option and initiate full-scale production of earth baseline satellites.
- Discontinue work on the earth baseline construction option and initiate full-scale production of satellites primarily constructed with lunar resources.
- Continue both paths. Construct initial production satellites with earth resources and switch over at some later date to lunar resources. The satellite must be specifically designed to accommodate this transition between construction material sources.

5. Start-up for Full Scale Satellite Production Phase

Develop and deploy transportation systems and facilities needed to support production and operation of full-scale satellites. The preceding decision may result in proceeding with only one path. Path unique vehicles and facilities are identified in Figure 6-1. Both the earth baseline and LRU option can utilize the demonstration satellite and its support equipment as part of the full-scale manufacturing facilities. The demonstration satellite can be adapted to provide space manufacturing facility power. The construction jig can either be expanded for similar application with production satellites or could be utilized for assembling COTVs in LEO. The launch vehicles developed for the demonstration satellite (SDV, POTV, COTV) should be acceptable for use with the LRU option due to its low quantity requirement for earth-delivered materials.

6. Production and Operations Phase

Full-scale satellites are constructed and maintained to provide useful earth services. Three development phases for the earth baseline and LRU construction programs are identified in Figure 6-1. These three phases consist of terrestrial development tests, early space development tests, and system development tests, and contain the majority of system element requirements which distinguish between the two construction techniques. These system elements have been organized into transportation-related, product design-related, product manufacturing-related, and infrastructure-related categories in Tables J-1 through J-4, respectively, of Appendix J. The reference NASA-JSC 10 GW solar power satellite has been used as the product example for Table J-2, as it was in the preceding study technical tasks. LRU system Concept B has been employed as the representative lunar material use option.

A top-level comparison of these development requirements has been made by assigning each system element one of the following designations:

1. A common element which exhibits similar development requirements for both the earth baseline and LRU construction options.
2. A LRU peculiar element which is based on development requirements similar to those for another element in the earth baseline option.
(Such as a habitat or propellant depot used in another orbital location.)
3. A unique element for which no corresponding development requirement exists in the alternative program.

The thirty-two system elements described in Appendix J of Volume III have been assigned these designations, and the results obtained are summarized in Table 6-1.

Table 6-1. System Element Development Comparison.

Designation	Element Category				Total
	Transportation (Table 6-1)	Satellite System (Table 6-2)	Manufacturing (Table 6-3)	Infrastructure (Table 6-4)	
1) Common Elements, Similar Reqts	3	4	2	3	12
2) Peculiar Elements, Similar Reqts	1	0	0	5	6
3) Unique Elements, Dissimilar Requirements	2 LRU 1 B/L	3 LRU	5 LRU	3 LRU	14
Total	7	7	7	11	32

Fourteen of these 32 system elements, or 44 percent, are unique to either the lunar resources utilization program or the earth baseline program. The earth baseline program has only one unique element, i. e., HLLV development, while LRU requires development of 13 unique items such as the mass driver catapult, lunar mining equipment, lunar habitat, and the space manufacturing facility.

It is the successful development of these 13 LRU program unique system elements, plus the extended duration required for production start-up to implement lunar mining and space manufacturing facilities, which become important program assessment points for the decision analysis.

6.2 PROGRAM DEVELOPMENT SCHEDULES

An example earth baseline SPS program schedule has been generated to span from 1979 through completion of the first commercial satellite. The key milestones used in developing this schedule were obtained from the "SPS Concept Development and Evaluation Program" reference system report, issued by DOE and NASA in October 1978. The key

milestones are:

- Joint DOE-NASA Final Program Recommendations - June 1980
- Technology Availability Date is 1990
- SPS Operational Date is Year 2000

In addition, we have assumed that a demonstration satellite will be built and tested three years following the technology readiness date. We think a scale demonstration of useful space power generation and transmission will be a political requisite to embarking on a commercial SPS program.

Figure 6-2 shows the example earth baseline SPS program schedule derived from the key milestone information. The schedule is organized into two major headings; technology development, and space systems development. Also shown are milestones and decision points associated with go-ahead for major hardware items and economic assessment of SPS with other terrestrial power generation techniques. Two additional key milestones have been included with those used for schedule development. The achievement of interim technology goals in mid 1985 leads to the decision to build a demonstration satellite. This decision promotes escalated technology development testing in space, and provides go-ahead for launch vehicle final design and production. The other milestone is start-up for commercial SPS construction. This occurs two years prior to the 1.5 years needed for construction of the first commercial satellite. The two year start-up period encompasses delivery of transfer vehicles into low earth orbit (LEO), construction of the COTV assembly fixture and vehicle in LEO, transfer of SPS construction facility hardware to geosynchronous orbit (GEO), and assembly of this facility in GEO.

The only space system development schedule not directly tied to the construction of either the demonstration or commercial satellite is the LEO base. We have assumed that go-ahead for this facility will occur shortly after the shuttle becomes operational, and that its primary function will not be SPS related. The SPS development schedule shows LEO base availability in 1987, which would support space technology testing. The base would be subsequently expanded to support SPS demonstration and commercial construction programs.

A corresponding SPS development schedule for a lunar resource utilization program is depicted in Figure 6-3. This schedule retains the same early key milestones employed in the baseline schedule, and uses Concept B as the representative LRU implementation option. The year 2000, shown as the date for first commercial LRU SPS on-line, was not used as a given milestone. Our original approach assumed that one or more additional years might be needed between successful demonstration satellite operation and commercial SPS on-line to develop the LRU peculiar system elements and perform the more complicated start-up operations. We discovered, however, that the development of LRU peculiar elements and common elements could be conducted in parallel and the additional year required for startup could be scheduled within the 1993 → 1999 span to support the mid 2000 date for completion of SPS construction. Thus the earth baseline and lunar resource utilization schedules span the same period and terminate with completion of an equivalent end product. Therefore, all major decision points and key milestones contained in Figures 6-2 and 6-3 are compatible.

The LRU schedule in Figure 6-3 is also organized into two major sections; technology development, and space systems development. The technology development section includes that LRU peculiar technology work which must be accomplished in addition to the baseline technology work shown in Figure 6-2. The space systems development section includes all the major elements needed to perform the LRU SPS program. Some of these elements are also required to support the earth baseline program, but have been repeated in Figure 6-3 so their schedule relationship with LRU peculiar elements can be readily identified.

6.3 ACHIEVEMENTS NEEDED TO JUSTIFY FUNDING

Comparison of the earth baseline SPS and lunar resource utilization SPS schedules presented in Figures 6-2 and 6-3 indicates that only minor differences exist for development of common system elements. This compatibility presupposes that sufficient data exists to justify a decision to utilize either earth or lunar resources upon successful completion of demonstration satellite tests. If suitable information is not available, or the political

Figure 6-2. Example Earth Baseline SPS Program Plan - Summary Schedule

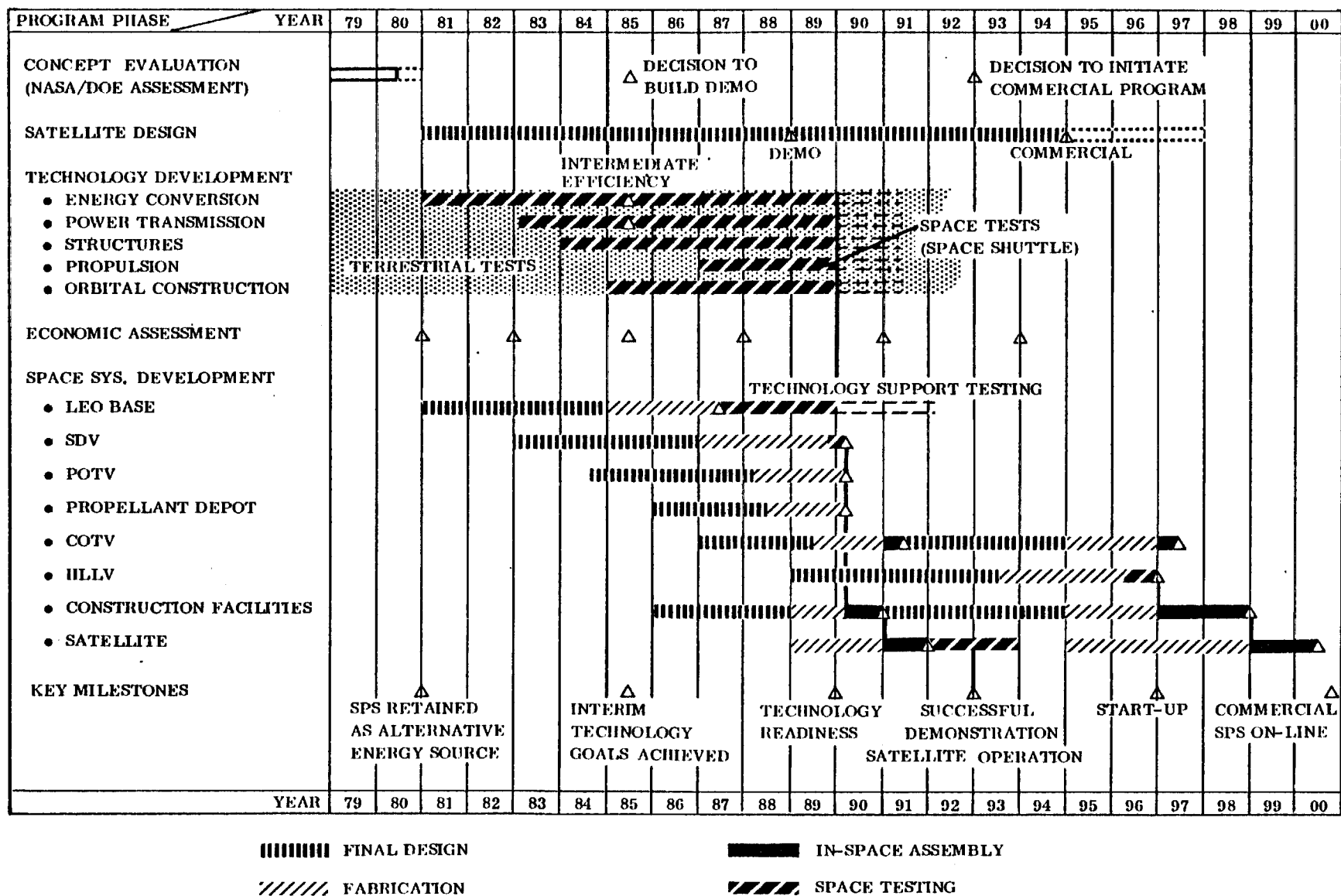
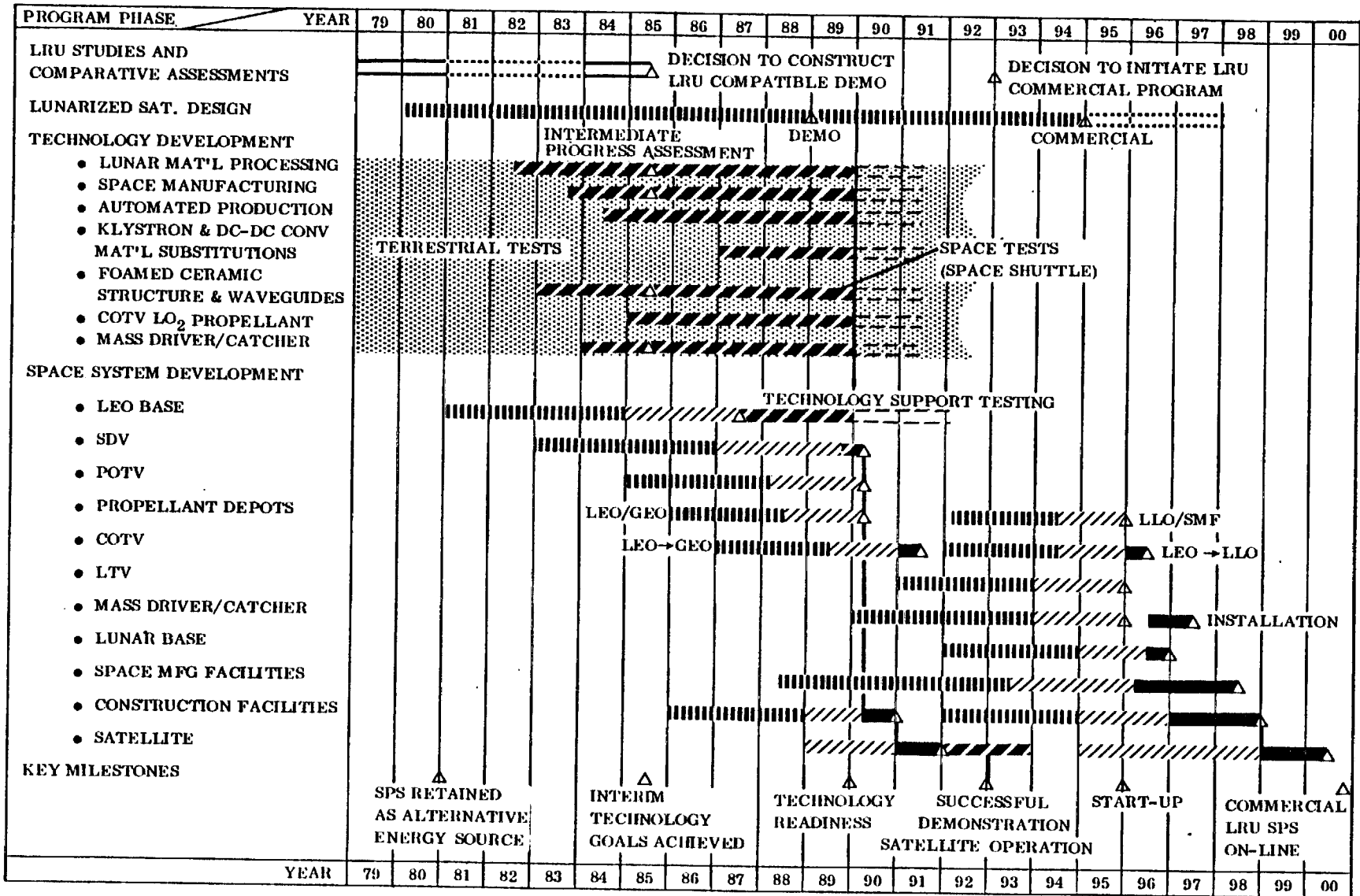

Figure 6-3. Example Lunar Resource Utilization SPS Program Plan - Summary Schedule



FINAL DESIGN

IN-SPACE ASSEMBLY

FABRICATION

SPACE TESTING

situation makes a clear-cut decision unwise, both earth and lunar based programs might be continued. In this parallel commercial program scenario, earth resources would be used exclusively for construction of early commercial satellites. Rapid transition to construction based primarily on lunar resources could be accomplished after a discrete production run of earth material satellites, or a gradual transition from earth to lunar materials could be accomplished during construction of several satellites. The achievements needed to justify LRU selection are similar for all of these scenarios, but are clearer for the either/or scenario which is assumed in the following description.

A simplified development schedule for the lunar resource utilization SPS program is shown in Figure 6-4. The first line on this schedule identifies two major and two supporting decision points which must be satisfied to continue with an LRU SPS program. The two major program decision points occur in mid 1985 and early 1993, and correspond to the commitment to construct a demonstration satellite and initiation of a commercial SPS program, respectively. Specific accomplishments must be achieved by these dates to support each decision. These accomplishments are listed in Table 6-2. The mid-1985 decision point accomplishments consist of launch vehicle and SPS technology developments needed to construct the demonstration satellite. These accomplishments are relatively independent of LRU considerations, and therefore the ten items listed in the left column of Table 6-2 are equally applicable to either the earth baseline or LRU SPS program. It is especially important for the LRU program, however, that these demonstration satellite development requirements do not preclude or adversely influence the eventual use of lunar resources for SPS construction.

The early 1993 accomplishments listed in Table 6-2's right column are primarily associated with lunar resource utilization. Only two items; successful demonstration satellite operation, and habitat development, are applicable to both the earth baseline and LRU commercial SPS program. Thus, the critical decision point for lunar resource utilization occurs in early 1993, with preceding supporting decision points in early 1982

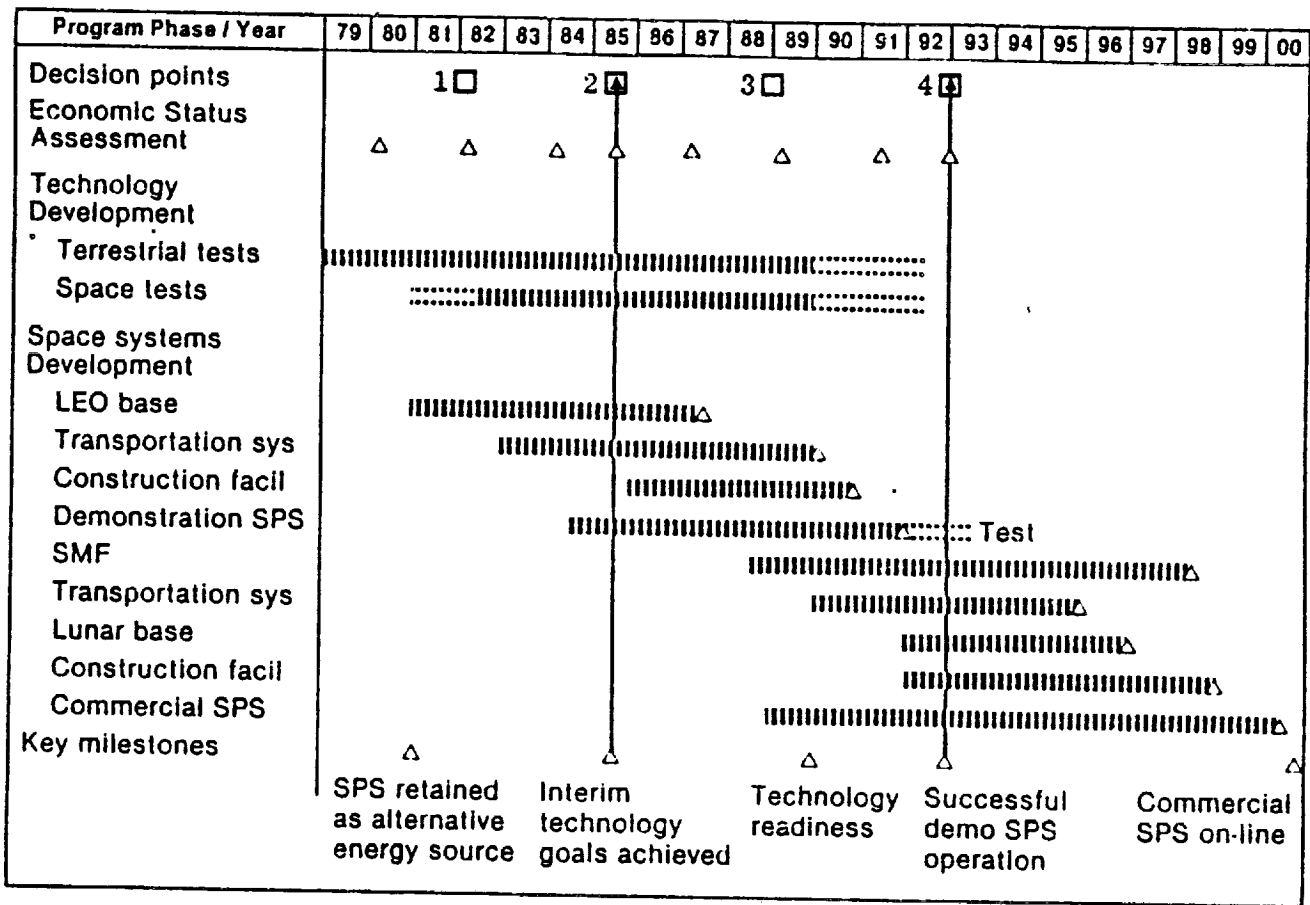

Figure 6-4. Example Lunar Resource Utilization SPS Development Schedule.

Table 6-2. Critical LRU Development Requirements.

To support a decision to construct a demonstration SPS Target decision date — mid 1985	To support a decision to initiate a commercial LRU SPS program Target decision date — mid 1993
<p>Commit to develop</p> <ul style="list-style-type: none"> • LEO space platform • Shuttle-derived vehicle • Personnel orbital transfer vehicle <p>Demonstrate technology readiness</p> <ul style="list-style-type: none"> • Ion-electric COTV • Propellant depot • Large space structures • SPS microwave power transmission • Low-cost solar cells <p>Assurance of</p> <ul style="list-style-type: none"> • SPS economic competitiveness • SPS environmental issues resolution 	<p>Successful demonstration of</p> <ul style="list-style-type: none"> • Solar power demonstration satellite • In-space processing of simulated lunar material • Silicon refining • Oxygen liquefaction • Space manufacturing • Modular habitats <p>Demonstrate technology readiness</p> <ul style="list-style-type: none"> • Mass driver catapult • Mass catcher • Ion-electric COTV oxygen thrusters <p>Completion of lunar resources survey</p> <p>Economic substantiation of LRU SPS</p>

and early 1989 needed for interim assessment of LRU technology readiness. Corresponding decision points in Figures 6-1 and 6-4 are identified by the numbers 1 through 4.

The achievements identified in the preceding discussion are associated with the development status of required technologies and commitments to produce critical system hardware elements. In conjunction with these achievements, incremental assessments of lunar resource utilization economic feasibility must be performed. LRU cost effective status should be updated at regular intervals to provide visibility into the effects that technology achievements have on the overall viability of satellite construction using lunar resources. As a minimum, these economic status reviews should correspond with the decision points identified in Figure 6-4. Additional intermediate reviews in early 1980, early 1984, early 1987, and mid-1991 would also be worthwhile to ensure that actual developments do not adversely affect the predicted benefits of lunar resource utilization.



RECOMMENDATIONS (TASK 5.7)

TASK — Recommend further analyses or investigations which would provide additional verification and support of study conclusions on the feasibility of using lunar resources for space construction and techniques to attain this capability. A plan, including costs and schedule, for conducting such recommended future work shall be prepared.

APPROACH — Identification of LRU areas requiring additional effort has been obtained from results of the technical feasibility assessment of Task 5.3, the preliminary decision analysis of Task 5.5, and the sensitivity and uncertainty analyses of Task 5.6. Recommendations and plans have been prepared in two general categories:

- Activities required to reduce the uncertainties in study conclusions.
- Activities related to the attainment of LRU capability.

The need for continued activities in the first category arises from uncertainties in the technical and economic data used to develop the study conclusions on LRU feasibility. Results of Task 5.6 have indicated that RDT&E key cost uncertainty contributors include major space facilities and transportation vehicles. Additional definition of these elements is required to reduce the uncertainty in study conclusions, especially those pertaining to the LRU material requirements threshold point.

Recommended activities in this category include more detailed system studies of the most favorable LRU concept which uses the mass driver catapult for lunar material transport and performs all material processing and production in a space manufacturing facility. Study results have indicated that solar cell manufacturing is the major contributor to space manufacturing facility cost, which has a relatively large uncertainty factor. This should be further analyzed to improve the LRU feasibility assessment.

Also included in the first category are recommendations and plans for additional risk and decision analyses. Such supplementary efforts are required to provide NASA with a basis for decisions regarding the implementation of LRU activities.

The second category of recommendations and plans is concerned with those activities which should be accomplished as steps toward the eventual attainment of LRU capability. These activities pertain primarily to technology developments such as lunar material substitutes for SPS components, space processing and manufacturing techniques, and unique transportation vehicle subsystems including the mass driver, mass catcher, and oxygen ion-electric thruster.

Recommended future activities from both categories have been compiled into an overall plan for future LRU activities. This plan identifies each activity element and includes a schedule and estimated costs. Interrelationships between activity elements have been considered in developing the schedule data.

The following writeup, Subsection 7.1, provides a shopping list of potential system study tasks and technology development activities. Subsection 7.2 ranks these activities and provides a suggested schedule for their implementation. LRU-related Shuttle technology experiments are proposed in Subsection 7.3.

7.1 RECOMMENDATIONS FOR FURTHER WORK

Additional activity associated with lunar resources utilization can be segregated into two types; system level paper studies which augment and expand the work conducted by this study, and technology studies which concentrate on developing the long lead technology needs which are peculiar to LRU. These technology studies generally include experimental work which can be initially conducted in a laboratory, but which may eventually require Shuttle-based space verification testing.

7.1.1 SYSTEM STUDY RECOMMENDATIONS

Study tasks have been organized into three categories:

- Updated study tasks — results of study work and reviewer comments have identified technical data which should be modified or revised. The effect of these revisions on overall study results should then be evaluated.
- Expanded study tasks — tasks in the current study were limited in both scope and depth by schedule and funding limitations. Our preliminary results have indicated areas where expanded study activity should be beneficial.
- New study tasks — useful investigative activities outside the scope of the current study.

Updated Study Tasks

1. All LRU concepts in the current study assumed use of the Space Shuttle (Orbiter + External Tank + Solid Rocket Boosters) for launch and return of all space personnel. The SDV (Orbiter + External Tank + Flyback Booster) was employed exclusively for cargo delivery. Lower costs should result if the SDV is also used as a personnel launch vehicle, due to its increased reusability and reduced operating costs. Assess SDV use for personnel transport.

2. Ion-electric COTV velocity requirements for cargo transfer between major activity locations were conservatively based on those for self powered SPS modules which use a significant percentage of their propellant for attitude control. Smaller COTV arrays, less thrusters, and reduced propellant requirements should result if more reasonable ΔV values are employed. Evaluate COTVs with less conservative ΔV requirements.

3. Power requirements for the lunar base were assumed to be supplied by nuclear reactor with a Brayton tubomachinery driven generator. The estimated mass used for this equipment appears to be optimistically low. A lunar base power supply trade study should be conducted to evaluate a revised nuclear system with various solar powered concepts. (See expanded study tasks.)

4. Revise the steady state material requirements logistics scenario and start-up requirements for LRU Concept B. Incorporate the revisions noted above, plus the following:

- a. Updated personnel requirements as estimated in Subsection 4.9.
- b. Updated SPS material requirements as estimated in Subsection 4.7.
- c. Update habitat requirements to accommodate the revised personnel estimates.
- d. Include other suitable revisions obtained from results of expanded and new study tasks.

5. Revise the LRU Concept B nominal cost estimate to incorporate the effect of updated steady state logistics and startup results.

6. Revise the uncertainty analysis to incorporate nominal cost revisions from the preceding task, and adjust element uncertainties based on improved definitions obtained from expanded and new study task results.

Expanded Study Tasks — Transportation Related

7. Preliminary conceptual design of modular ion-electric cargo orbital transfer vehicle (COTV) using oxygen propellant; including configuration, orbital construction procedure, maintenance techniques, mass estimates, performance data, and transfer trajectories/timelines.

8. Preliminary conceptual design of the lunar mass driver catapult; including configuration, construction technique, maintenance requirements, mass estimate, and performance data.

9. Trade study of possible mass catcher material arresting equipment and propulsion system(s) designs. The propulsion system design should incorporate both the catcher maneuvering/positioning requirements and terminal tug transfer/docking requirements.

Based on trade study results, conduct a preliminary conceptual design of the mass catcher; including configuration, maintenance techniques, mass estimate, and performance data.

10. Improved conceptual design of Shuttle derived vehicle (SDV). Perform trades of booster configuration, booster propellants, and payload capability. Evaluate possible cargo pod and propulsion module configurations to promote their reusability and reduce operational costs. Define a personnel launch vehicle version of SDV which will use the Shuttle orbiter to transport personnel.

11. Preliminary conceptual design of the personnel orbital transfer vehicle (POTV); including configuration, mass estimates, crew accommodations, and performance characteristics. Conduct a trade to assess utilization of common versus kitted POTVs for alternative transportation routes. A single-stage POTV shall be assumed for all transfers since propellant resupply will be available at all terminals.

12. Preliminary conceptual design of the lunar transfer vehicle (LTV); including configuration, mass estimates, crew accommodations, and performance characteristics. Evaluate cargo capacity and accommodations needed to support delivery of lunar base facilities and equipment during startup.

Expanded Study Tasks — Material Processing

13. Define additional investigations and technology developments required to successfully process lunar minerals into SPS materials, parts and assemblies.

14. Make a more detailed comparative evaluation of the electrolytic, carbothermal and other processes for the production of large quantities of oxygen from lunar minerals.

15. Make a comparative evaluation of lunar and SMF based operations for:
 - a. Extraction of metals from lunar minerals.
 - b. Conversion of metal ingots, powder, etc., into sheet, plate, wire, castings, and other shapes and forms.
 - c. Purification of solar cell grade silicon.

16. Evaluate processes for extraction of gases and minor alloying elements from lunar minerals and compare the advantages of lunar sources of these materials to providing them from earth. (hydrogen, carbon, water, magnesium, chromium, nickel, etc.)

17. Evaluate competitive processes for the preparation of solar cell grade silicon from the metallurgical grade.

18. Perform a trade study of the space manufacturing facility; including general layouts, material logistics and parts handling, mass, volume, power requirements, and level of automation. Investigate alternative management approaches for the SMF. Include concepts from independent ownership of discrete component manufacturing facilities to a vertically integrated SMF owned and operated by a single entity. Develop economic comparison data and evaluate social/political ramifications of the alternatives. Estimate the effect these various organizational approaches have on facility design.

Expanded Study Tasks — Infrastructure

19. Lunar base power supply trade study. Evaluate alternative sources for electrical power including nuclear Brayton, photovoltaic with conventional storage, and photovoltaic with orbital mirrors for night operation. Determine equipment mass requirements and operating characteristics. Select the best power supply option and prepare a preliminary conceptual design including configuration and mass data.

20. Preliminary conceptual design of modular habitats suitable for all LRU activity locations. Develop building block modular concept consisting of earth delivered units capable of housing from 60 to 1400 persons. Provide configuration, functional, and support characteristics for each habitat space location.

Expanded Study Tasks — System Level Trades

21. SMF location trade study. Compare possible locations for the space manufacturing facility of LRU Concept B to determine the effect that different locations have on steady state operating material requirements. Possible locations include L₅; 2:1 resonance orbit, and geosynchronous orbit.

22. Lunar base trade study. Compare various lunar surface base locations for LRU Concepts B and C. Compare study state material logistics and power generating requirements. Assess operating penalties associated with transfer of material from these lunar bases to the SMF.

23. Perform a second generation economic analysis to compare earth baseline and updated LRU Concept B program costs. Incorporate results from the revised nominal cost estimate (updated study Task No. 5), and results of the preceding expanded study tasks. Special emphasis shall be directed toward evaluation of differences between earth manufacturing costs and in-space manufacturing cost of SPS components. Develop more detailed economic comparisons of the earth-based and space-based manufacturing procedures.

New Study Tasks

24. Evaluate the use of bootstrapping during startup to reduce the facilities and the equipment which must initially be delivered from earth. Determine the additional startup time needed to accommodate a bootstrapped approach.

25. Evaluate a bootstrapped SPS production program and compare its schedule and costs with a steady state production program. Perform a trade to determine what percentage of total SMF production capability is employed to increase SPS manufacturing capacity as a function of bootstrapping rate.

26. Redesign of SPS for maximum compatibility with lunar-derived materials. Estimate SPS mass and manufacturing facility requirements as a function of SPS LRU percentage.

27. Evaluate what effect potential new developments on SPS design might have on the utilization of lunar resources and the LRU material requirements threshold. Investigate possible breakthroughs in solar cells (thermionic devices), DC-DC converters, and Klystrons.

28. Determine the effect of employing asteroidal material for SPS production in addition to or in place of lunar materials. Evaluate effects on SPS design, operating scenarios, startup procedures, and total program cost.

29. Evaluate the sensitivity of automation level on SMF design, personnel requirements, and LRU program cost. Determine if optimum automation level(s) for space manufacturing can be found, and if such an optimum exists, estimate its operating requirements.

30. Perform expanded economic assessments based on the revised economic analysis and improved definition of LRU System Concept B. These assessments should include a more detailed uncertainty analysis, cost payback analysis, and energy payback analysis.

7.1.2 TECHNOLOGY STUDIES

1. Development of Ion-Electric Thrusters for Oxygen Propellant -- The most suitable ion-electric vehicle propellant available in lunar resources is oxygen. Theoretical

performance of oxygen in ion thrusters is almost as good as argon, but extensive study and testing is needed to develop thruster cathodes, screens and other components which are suitably impervious to oxidation.

2. Development of In-Space Oxygen Liquefiers — Lunar-derived oxygen must be liquified to obtain a high density propellant with reasonable container requirements and handling properties. Early development of a small-scale prototype for operation in the zero-g space environment will also support a probable requirement for reliquefiers in propellant depots.

3. Research on Mass Driver Catapult Linear Electromagnetic Accelerator — Expand Princeton/MIT technology activities on mass driver prototypes. Continue development and testing of the basic accelerator section and bucket design. Initiate work on payload alignment stations and bucket loading equipment. Prepare a prototype for vacuum tests.

4. Research on Mass Catcher Material Stream Arresting Equipment — Develop possible candidate materials and bag configurations capable of arresting and retaining the stream of lunar material delivered by the mass driver catapult. Develop simple test models and conduct tests.

5. Research on Large Space (and Lunar Surface) Radiators — Develop modular radiator configuration which could utilize lunar materials for the radiator structure, and if possible, the transport media. Conduct prototype tests to demonstrate performance characteristics.

6. Research on Robotics Suitable for General Purpose Space Industrialization — Adaptability of high technology industrial robots to the space environment. Investigation of special problems associated with sensing, handling, and control in low-g environments.

7. Production of Solar Cells by Molecular Beam Epitaxy (MBE) — Thin crystals ($\approx 200^\circ \text{A}$) of Si and various III-V, II-VI and IV-VI compounds and alloys can be grown under precisely controlled conditions in a high vacuum (10^{-10} Torr). This will permit the production of large areas of efficient solar cells from a small quantity of material and lends itself to production in a space environment. Develop and evaluate the MBE process for the production of solar cells.

8. Research on Electrolysis of Silicates — Investigate the electrolysis of metallic oxysilicates (plagioclase, pyroxene, olivine, etc.) to recover oxygen and metallic elements. Study should include selection of low-cost, long-lived anode and cathode materials, means for the separation and recovery of individual elements such as Si, Fe, Al, Mg and Ca, determination of the efficiency of the process and investigation of factors which inhibit cell efficiency. This study should continue work performed by the Bureau of Mines and reported in RI7587.

9. Production of Foam Glass from Lunar Type Silicates — Investigate the production of structural foam glass from lunar type silicates (anorthosite, basalt, etc.), evaluate their mechanical and physical properties and fabricate and test sample structural elements, develop means of joining metallic and foam glass structural elements. Determine if fracture/strength characteristics can be improved by use of filaments combined with the foamed glass. Evaluate various filaments including glass and carbon.

10. Vacuum Distillation and Dissociation of Lunar Type Silicates — Investigate the recovery of oxygen and metallic elements from lunar type silicates by means of vacuum distillation and dissociation and develop means for separation and recovery of the individual elements.

11. Production of Fiberglass Filaments from Lunar Type Silicates — Investigate the production of fiberglass filaments from lunar type silicates in a vacuum and zero-g or low-gravity environment. Characterize the mechanical and physical properties of the

fiberglass and fabricate and evaluate the performance of sample electrical insulation and cylindrical containers made from the fiberglass.

12. Vapor Phase Deposition of Thick Sheet and Plate of Iron and Aluminum Alloys —

Develop the VPD process for the preparation of 1mm to 1cm thick sheet and plate of iron and aluminum base materials, including pure Fe and Al, 18-8 type stainless steel, and Al-Mg and Al-Si-Mg alloys. Characterize the mechanical, physical and electrical properties of the VPD materials.

13. Vapor Deposition of Thin Silica Glass for Solar Cell Substrates and Covers —

Develop a process for the vapor phase deposition of 50 μm to 100 μm thick silica glass sheet for application as solar cell substrates and covers. The sheet must be flat, smooth and highly transparent and separable from the substrate on which it is deposited. Dopants to enhance radiation resistance may be co-deposited with the glass.

7.2 TASK ASSESSMENT AND SCHEDULING

The forty-three recommended tasks described in Section 7.1 have been assessed to define their relative importance toward obtaining an improved understanding of lunar resources utilization. This assessment includes a relative ranking, recommended schedule for accomplishment, and a preliminary cost estimate. Table 7-1 includes this information for recommended system study tasks, and Table 7-2 identifies recommended technology development programs. An explanation of the assessment criteria employed in Tables 7-1 and 7-2 is given below.

- Relative Ranking — Numbers 1 through 4.

Number 1 denotes a task which has been identified as a direct result of work performed by this contract, and performance of this new task will substantially augment and improve our understanding of LRU's potential benefits. Number 4 indicates an interesting task with significantly lower influence on existing study results.

- Schedule — A 3-year schedule for performance of initial system and technology studies has been assumed. Number 1 indicates the task should be started immediately, Number 2 denotes task initiation during the second year, etc.
- Preliminary Cost Estimate — These estimates assume a nominal level of effort consistent with first or second generation definition studies. Some useful data could be obtained with lower funding levels, and considerably expanded understanding would probably result with increased funding levels.

Proposed schedules and funding profiles for system study and technology development activities are shown in Figures 7-1 and 7-2, respectively. Individual tasks have been assembled into compatible groupings to simplify scheduling. These groupings are also defined in Figures 7-1 and 7-2.

7.3 LRU SHUTTLE TECHNOLOGY EXPERIMENTS

Thirteen technology development tasks were identified in Subsection 7.1 as initial steps toward the eventual attainment of LRU capability. These tasks all consist of laboratory experiments to demonstrate processes and/or first-generation prototype hardware.

- Development of ion-electric thrusters using oxygen propellant
- Development of in-space oxygen liquefiers
- Research on mass driver catapult linear electromagnetic accelerator
- Research on mass catcher material stream arresting equipment
- Research on large space (and lunar surface) radiators
- Research on robotics suitable for general purpose space industrialization
- Production of solar cells by molecular beam epitaxy (MBE)
- Research on electrolysis of silicates
- Production of foam glass from lunar type silicates
- Vacuum distillation and dissociation of lunar type silicates
- Production of fiberglass filaments from lunar type silicates
- Vapor phase deposition of thick sheet and plate of iron and aluminum alloys
- Vapor deposition of thin silica glass for solar cell substrates and covers

Table 7-1. System Study Task Assessment.

System Study Recommendations	Relative Ranking	Schedule (Year)	Preliminary Cost Est (k\$)
1) Personnel Launch With SDV	2	1	4
2) Lower ΔV for COTV XFERS	1	1	4
3) Revise Lunar Power Facility	2	1	2
4) Revise Concept B Mat'l Reqts	1	1	8
5) Revise Nominal Cost Estimate	1	1	6
6) Revise Uncertainty Analysis	2	1	4
7) COTV Conceptual Design	3	2	12
8) Mass Driver Conceptual Design	3	2	16
9) Mass Catcher Trade Study	2	1	14
10) SDV Conceptual Design	3	2	20
11) POTV Conceptual Design	4	2	8
12) LTV Conceptual Design	4	2	10
13) Processing Technology Def.	2	1	16
14) Oxygen Production Options	3	2	10
15) SMF Versus Lunar Processing	2	1	8
16) Extraction of Minor Lunar Mat'ls	4	3	14
17) Silicon Refining Options	2	2	16
18) SMF Conceptual Design	3	3	48
19) Lunar Base Power Trade	2	1	12
20) Modular Habitat Design	4	3	16
21) SMF Location Trade	2	1	12
22) Lunar Base Location Trade	3	2	10
23) 2nd Generation Econ Analysis	3	2	20
24) Bootstrapped Start-up	1	1	12
25) Bootstrapped SPS Production	3	2	32
26) SPS Redesign for Max LRU	3	2	48
27) SPS Breakthrough Effects	2	2	8
28) Asteroidal Resources	4	3	48
29) SMF Sensitivity to Automation	3	3	32
30) Expanded Economic Assessments	1	1	20
Total			\$490

Table 7-2. Technology Development Task Assessment.

Technology Study Recommendations	Relative Ranking	Schedule (Year)	Preliminary Cost Est (k\$)
1) Oxygen Ion Electric Thrusters	1	2	1000
2) In-Space Oxygen Liquefiers	2	2	250
3) Mass Driver Accelerator	1	1	800
4) Mass Catcher	1	1	400
5) Large Space Radiators	3	2	300
6) Space Mfg Robotics	3	3	450
7) MBE Production of Solar Cells	2	2	750
8) Electrolysis of Silicates	1	1	500
9) Foamed Glass Production	2	1	350
10) Vac Distillation of Silicates	2	2	400
11) Fiberglass Prod From Silicates	2	1	150
12) Vapor Deposition of Metals	1	1	300
13) Vapor Deposition of Glass	2	2	350
Total			\$6,000

System Study Task Groupings	Proposed Tasks	k\$	Estimated Cost
A. Updated system study tasks	Personnel launch with SDV	4	\$28k
	Lower ΔV for COTV transfers	4	
	Revise lunar power facility	2	
	Revise Concept B matts reqts	8	
	Revise nominal cost estimate	6	
	Revise uncertainty analysis	4	
B. Early expanded trade studies & analyses	Mass catcher trade study	14	\$94k
	Processing technology def	16	
	SMF versus lunar processing	8	
	Lunar base power trade	12	
	SMF location trade	12	
	Bootstrapped startup	12	
	Expanded economic assessments	20	
C. Element conceptual design & LRU cost analysis update	COTV conceptual design	12	\$96k
	Mass driver conceptual design	16	
	SDV conceptual design	20	
	POTV conceptual design	8	
	LTV conceptual design	10	
	Lunar base location trade	10	
	2nd-generation econ analysis	20	
D. Material processing & SPS trade studies	Oxygen production options	10	\$114k
	Silicon refining options	16	
	Bootstrapped SPS production	32	
	SPS redesign for max LRU	48	
	SPS breakthrough effects	8	
E. Expanded & new study tasks	Extraction of minor lunar matts	14	\$158k
	SMF conceptual design	48	
	Modular habitat design	16	
	Asteroidal resources	48	
	SMF sensitivity to automation	32	

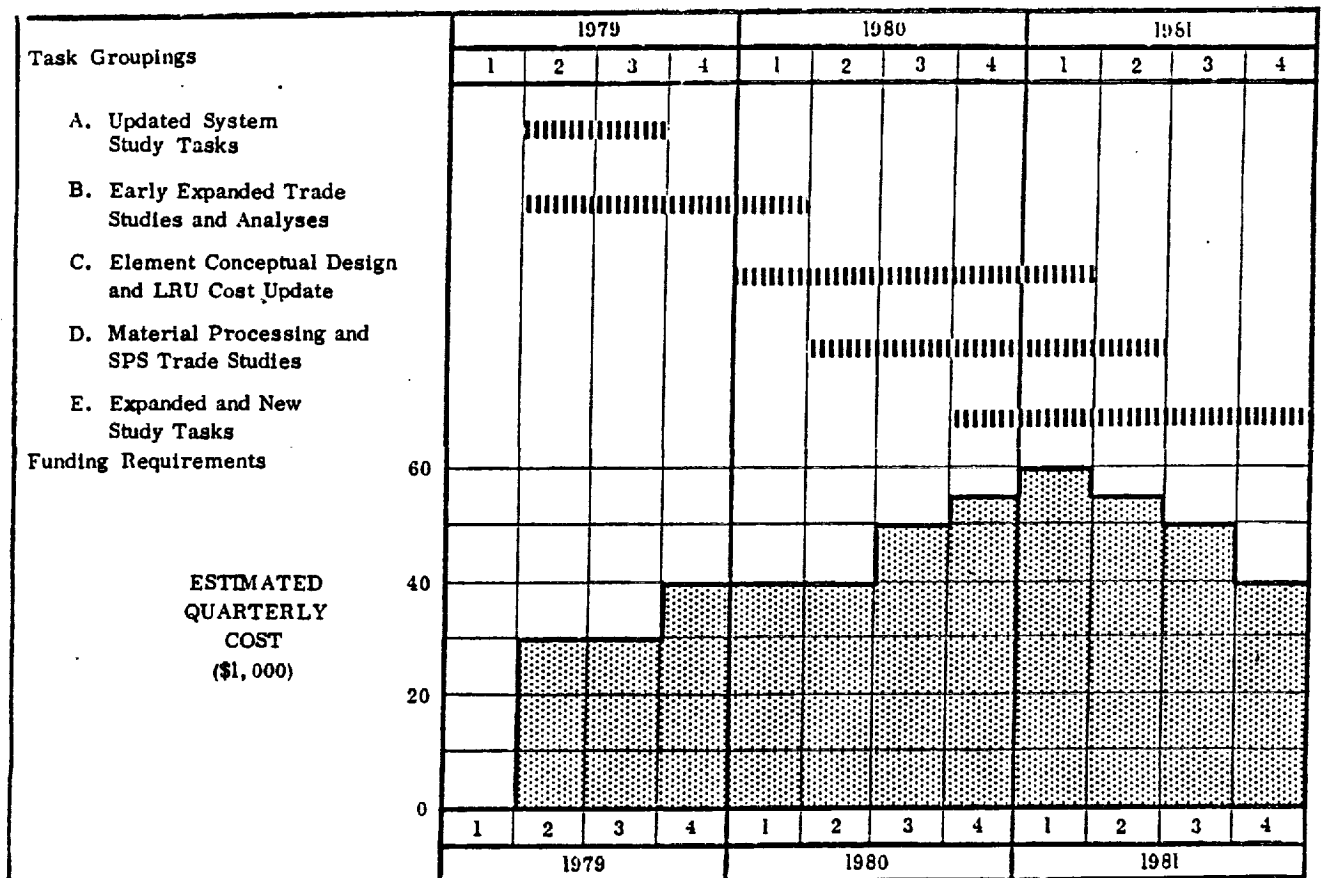

Figure 7-1. Proposed Schedule for System Study Tasks.

Technology Development Task Groupings	Proposed tasks	k\$	Estimated Cost
F. Mass driver catcher technology development	Mass driver accelerator	800	\$1,200 k
	Mass catcher	400	
G. Early processing & mfg technology development	Electrolysis of silicates	500	\$1,300 k
	Foamed glass production	350	
	Fiberglass prod from silicates	150	
	Vapor deposition of metals	300	
H. Oxygen ion electric thruster development	Oxygen ion electric thrusters	1000	\$1,000 k
I. Propellant production technology development	In-space oxygen liquefiers	250	\$ 550 k
	Large space radiators	300	
J. Subsequent process & mfg technology development	MBE production of solar cells	750	\$1,500 k
	Vac distillation of silicates	400	
	Vapor deposition of glass	350	
K. Automated processes development	Space mfg robotics	450	\$ 450 k

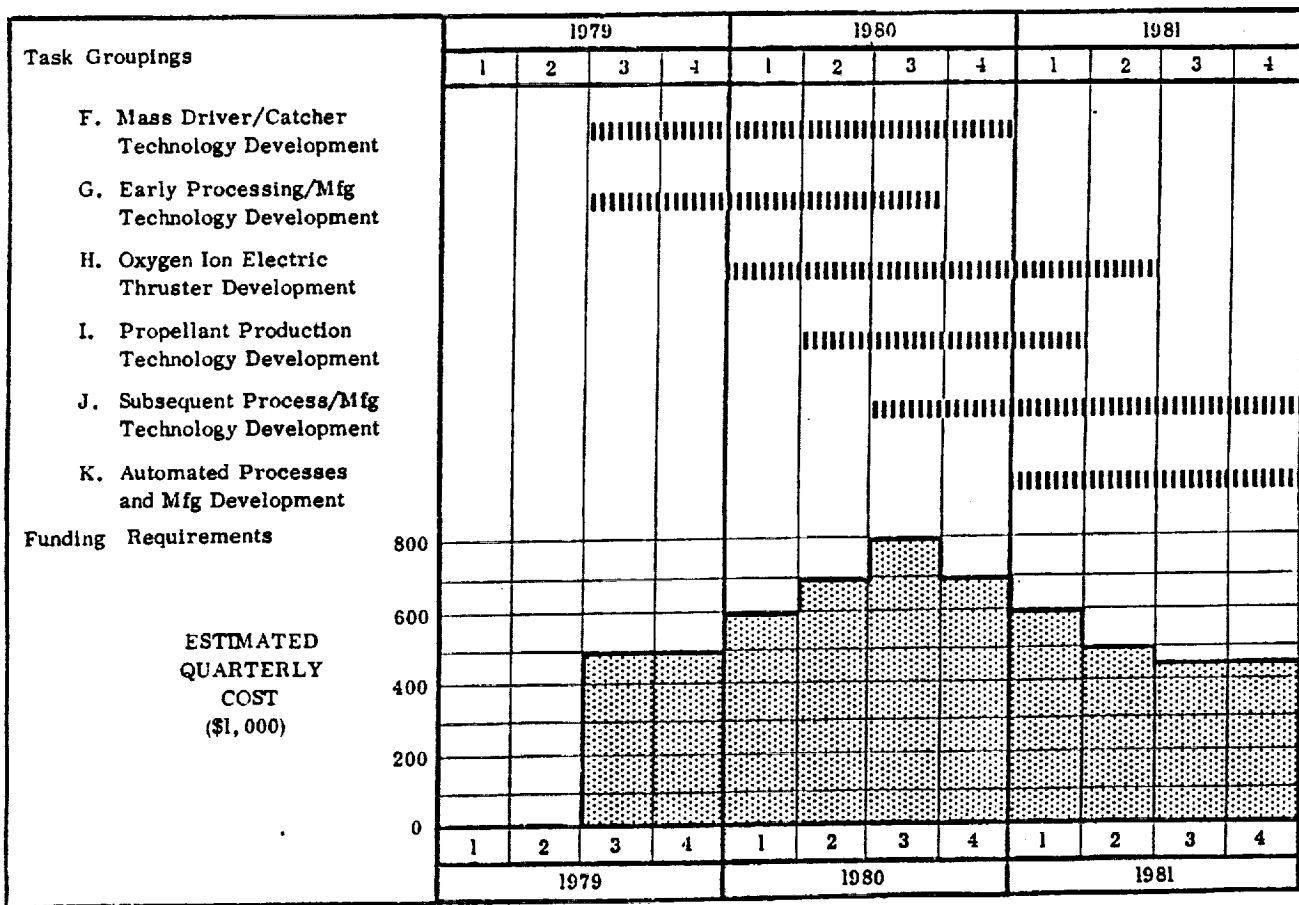

Figure 7-2. Proposed Schedule for Technology Development Tasks.

All these early conceptual evaluations of space processes or space system performance would be conducted in vacuum chambers. Short duration low-g testing could be accomplished via droptower or on-board a KC-135 aircraft. Eventually, however, many preferred LRU processing and manufacturing techniques will require demonstration in their expected operating environment. These tests would be accomplished via the space shuttle, either as special dedicated experiments or in conjunction with Spacelab or a science applications platform. The LRU related technology areas which at this time appear to require verification with space experiments are listed in Table 7-3.

Table 7-3. LRU Shuttle Technology Experiments.

- Vapor deposition of aluminum & iron on a molybdenum strip
 - Perform vacuum deposition in zero-g
 - Demonstrate metal separation from Mo sheet following deposition
- Melting & casting of aluminum, iron & sendust (85% Fe - 10% Si - 5% Al)
 - Perform casting at zero-g & low controlled g
 - Demonstrate both permanent metal mold & sand-plaster mold casting
- Reacting SiO₂ to form high-purity silica glass
 - Manufacture of thin silica sheet & glass filaments
- Manufacturing of foamed glass elements from simulated native lunar glass, including structural shapes & waveguide sections
- Electroplating aluminum with copper in zero-g
- Vapor depositions of aluminum on silicon wafers through maskant
- Liquefaction of oxygen in zero-g & 1/6 g



8

REVIEWER CONTRIBUTIONS

At the request of NASA's Johnson Space Center, the Convair Division of General Dynamics Corporation arranged for a group of independent experts to perform critical review of work performed under Contract NAS9-15560, "Lunar Resources Utilization for Space Construction." These experts consisted of nationally recognized authorities on lunar materials and/or space industrialization and were the originators of many concepts considered during the study. The primary purpose of this group was to assure that the concepts and systems defined, evaluated and compared represented the best current proposals and were treated objectively.

The following individuals were retained by General Dynamics to perform the study technical review function:

- Dr. Jim Arnold - University of California at San Diego, La Jolla, California
- Gerald Driggers - Southern Research Institute, Birmingham, Alabama
- Dr. Art Dula - Butler, Binion, Rice, Cook & Knapp, Houston, Texas
- Dr. John Freeman - Rice University, Houston, Texas
- Dr. Gerry O'Neill - Princeton University, Princeton, New Jersey

These reviewers were encouraged to provide independent assessment of study concept definitions, comparative evaluation techniques and results. Copies of study monthly reports were sent to reviewers, and their comments and suggestions contributed to subsequent study activities. Reviewers had an 80% attendance at the contract mid-term and final presentations, where they participated in informal discussions with study personnel, and provided critical assessment of work performed.

Each reviewer was requested to submit a contribution for the study final report. These contributions have been compiled in this section. Comments were solicited in three areas:

- Brief statement of significant contributions reviewers thought were made by this study toward improved understanding of lunar resource utilization. Specifically interested in identifying approaches, data, evaluation techniques or results that seem especially worthwhile.
- Statement identifying the study approach, constraints, assumptions, or data which reviewers felt might limit the usefulness or restrict the applicability of study results. This statement should identify the offending parameter(s) and indicate the alternatives which should be considered to obtain improved results. These comments will be especially constructive if they can be oriented toward specific study follow-on recommendations.
- A study related treatise expounding on each reviewer's specific area(s) of interest. This can be an expanded discussion of alternative study approaches from the preceding paragraph. This section provided each reviewer the opportunity to introduce new or unusual ideas for possible consideration in follow-on activities.

Reviewer contributions have been organized into six subsections. The first subsection, by way of introduction, includes brief resumes and background information for each reviewer. This is followed by a separate subsection containing each reviewer's comments. Comment references all pertain to this volume (Volume II) of the final report unless specifically noted otherwise. In some instances, editorial comments have been included by the study manager. These are contained in parentheses.

8.1 REVIEWER RESUMES

Abbreviated resumes for each of the five study technical reviewers are contained in this subsection.

DR. JAMES R. ARNOLD

Professional Position: Professor of Chemistry
University of California, San Diego
La Jolla, California 92093

Education: A.B., Princeton University, 1943
M.A., Princeton University, 1945
Ph.D. Chemistry, Princeton University, 1946

Experience: During his graduate work at Princeton University, Dr. Arnold was associated with the Manhattan (atomic bomb) Project for two years.

On completing his doctorate training, Arnold went to the University of Chicago as a postdoctorate Fellow in its newly formed Institute for Nuclear Studies. In 1947 he moved to Harvard University as a National Research Fellow. In 1948 he returned to the University of Chicago to begin work with W. F. Libby in the development of radio-carbon dating, after which he became a member of the faculty there. In 1955 Arnold joined the chemistry department of Princeton University. His appointment as an Associate Professor of Chemistry at the University of California, San Diego began in 1958 and he was appointed Professor and first chairman of the Department of Chemistry in 1960.

In the 1950's he was one of the developers of the liquid scintillation spectrometer for C^{14} and H^3 . He discovered the cosmic-ray-produced Be^7 (53-day) and Be^{10} (2.5 million year) isotopes in nature, and studied their distribution in the natural environment.

Since 1960 his work has been mainly on cosmic-ray products in meteorites and in lunar samples. With D. Lal, M. Honda, J. Shedlovsky and others he demonstrated the approximate constancy of the cosmic ray flux over periods up to millions of years. This work has also been applied to the history of meteorites in the solar system, and has been accompanied by theoretical studies on the origin of these objects.

He and his coworkers have been active in lunar sample studies since Apollo 11. Their work has shown that the rate of emission of high energy particles in solar flares has been approximately constant over millions of years. With A. E. Metzger and others he conducted a gamma ray mapping experiment on Apollo 15 and 16; they found a remarkable concentration of the heat-producing radioactive elements in the areas of Oceanus Procellarum and Mare Imbrium.

In 1966-68 he served on the International Technical Cooperation and Assistance Panel of the President's Science Advisory Committee, under the chairmanship of Dr. Herbert York. He was a member of the Space Science Board of the National Academy from 1971 to 1974. He is now a member of the Academy's Committee on Science and Public Policy.

Arnold is a member of the American Association for the Advancement of Science and the American Chemical Society. He was elected to the National Academy of Sciences in 1964 and was a recipient of the Atomic Energy Commission's E. O. Lawrence Award in 1968. In 1969 he was elected to the American Academy of Arts and Sciences. He studied in India under a Guggenheim Fellowship in 1972-73. He was honored by NASA in 1971 with its Group Achievement Award for his lunar orbital experiments and again in 1972 with its medal for Exceptional Scientific Achievement.

Dr. Arnold has published 85 technical papers and articles during the past 33 years.

MR. GERALD W. DRIGGERS

Professional Position: Section Head, Applied Thermal Section
Southern Research Institute
Birmingham, Alabama 35215

Education: Auburn University, Auburn, Alabama: September 1962 to March 1968. (Graduated with Bachelor of Science in Aerospace Engineering.)

Auburn University: March 1973 to June 1974. (Master of Science in Aerospace Engineering.)

University of Alabama in Birmingham: September 1974 to Present. Additional study in Math and Bio-Engineering.

Experience:

July 1978 - Present

Section Head, Applied Thermal Section, Southern Research Institute, Birmingham, Alabama. Directs application of experimental capabilities and evaluation of thermal and environmental effects on material properties. Planning and managing new applications of materials research capabilities to weapon systems, new energy sources and space related requirements.

June 1977 - July 1978

Aerospace Engineer, Science Applications, Incorporated (SAI), Huntsville, Alabama. Managing and participating in studies of: space industrialization; processing and manufacturing in space; space technology applications; and alternative energy sources, both ground and space based.

July 1974 - June 1977

Research Engineer, Southern Research Institute, Birmingham, Alabama. Specialization in evaluation of materials at elevated temperatures, system design support and space systems studies.

Previous experience included a teaching assistantship and research while obtaining his masters degree, and as an Aerospace Systems Analyst for the United States Air Force Space and Missile Systems Organization.

Mr. Driggers is an active member of several technical societies (including AIAA and AAS) and defense associates, and participates in technical committee work and public relations activities supporting science and technology.

He has 21 publications and presentations, including the following which are associated with space industrialization or the utilization of nonterrestrial materials:

- "A Baseline L5 Construction Station". Princeton University Conference on Space Manufacturing Facilities, May 7-9, 1975.
- "Defining Shuttle and Tug Requirements for Large Space Facility Construction." Presented at Twenty-first Annual Meeting of AAS, August 26-28, 1975.
- "Industry in Space: The Dawning Prospects". Bulletin of the Southern Research Institute Vol. XXXIX, No. 1, Summer 1976.
- "Establishment of a Space Manufacturing Facility", with Jon Newman AIAA Progress in Astronautics and Aeronautics Series, Vol. 57, 1977.
- "A Factory Concept for Processing and Manufacturing with Lunar Materials." AIAA Paper 77-538, Third Princeton/AIAA Conference on Space Manufacturing, May 9-12, 1977.
- "Systems Analysis of a Potential Space Manufacturing Facility". AIAA Paper 77-554, Third Princeton/AIAA Conference on Space Manufacturing May 9-12, 1977.
- "Systems Analysis of Space Manufacturing From Nonterrestrial Materials." IAF Paper 77-72, XXVIIIth Congress of the International Astronautical Federation, Prague, Czechoslovakia, September 25 - October 1, 1977.

DR. ARTHUR M. DULA

Professional Position:	Technological Lawyer Butler, Binion, Rice, Cook & Knapp 1100 Esperson Building Houston, Texas 77002
	Adjunct Associate Professor of Law Bates College of Law University of Houston Houston, Texas 77004
Courses Taught:	Environmental Law and Policy Federal Jurisdiction, Insurance, Comparative Law and Ethics
	Consultant: Medical Physics University of Texas System Cancer Center M. D. Anderson Hospital Houston, Texas

Education: Juris Doctor with honors - May 1975
 Tulane University School of Law
 New Orleans, Louisiana 70118

 Graduate Study in Theoretical Inorganic Chemistry
 Georgia Institute of Technology
 Atlanta, Georgia

 B.S. 1970 - Chemistry Minor: Mathematics
 Eastern New Mexico University
 Portales, New Mexico 88130

Experience: Active in space law and space industrialization legal activities for the past two years. Served as program chairman for related symposiums and has published and lectured extensively. Dr. Dula is a member of fifteen legal, technical and philanthropic organizations including the American Bar Association, AIAA, British Interplanetary Society, IEEE, International Institute of Space Law, and the American Chemical Society.

His 25 presentations and publications include:

- "Space Law for Business Planners", Journal of Contemporary Business, University of Washington, Winter 1978.
- "Microwave Radiation", Jurimetrics Journal, American Bar Association, Summer 1978, Volume 18, No. 4.
- "How Does Industry View Space Industrialization?", Aeronautics and Astronautics, May 1977, p. 44.
- "Frontier Law - The Law of Outer Space", University of Houston Alumni Magazine, Albertus Magnus, January 1977 (reprinted in The Legal Advocate, July and August 1977).
- "Legal and Economic Prerequisites to Space Industrialization", Proceedings of the 19th Colloquium, International Institute of Space Law, I. A. F., Anaheim, October 1976.
- "Management of Inter and Third Party Liability for Routine Space Shuttle Operations", Drake Law Review, Insurance Law Annual, Fall 1977.
- "Legal Issues Raised by the Use of Extraterrestrial Resources", University of Houston, Law Review, 1978.

DR. JOHN W. FREEMAN

Professional Position: Director, Space Solar Power Research Program and Professor of Space Physics and Astronomy, Rice University.

Courses Taught: Introduction to Space Science - The Origin and Evolution of the Solar System - Plasma Physics - Freshman and Sophomore Physics Labs - Experimental Methods of Space Physics and Astronomy.

Consultant, NASA

Education: B.S. - Physics, Beloit College, Beloit, Wisconsin, 1957
M.S. - Physics, State University of Iowa, Iowa City, 1961
Ph.D. - Physics, State University of Iowa, Iowa City, 1963

Physics Dissertations:

- A Satellite Borne Cadmium Sulfide Total Corpuscular Energy Detector.
- The Morphology of the Electron Zone and Near the Magnetospheric Boundary as Observed by Explorer 12. (Under James A. Van Allen).

Experience: Since September 1977 Professor Freeman has served as Director of the Rice University Space Solar Power Research Program. This program involves research in seven (7) areas related to the feasibility of the SPS concept including:

1. SPS cost analysis
2. Rectenna siting
3. Microwave bioeffects
4. Space plasma effects on the SPS
5. Microwave beam ionosphere interactions
6. Rectenna lightning and severe weather protection
7. Alternate solar energy conversion devices

Professor Freeman is Principle Investigator of a NASA contract to evaluate the effects of the space environment on the solar power satellite. He is also involved in directing research on the feasibility of offshore rectennas for SPS and the development of the photoklystron, an A. C. or R. F. solar cell.

Specialized Research Areas:

- Measurement of Low-Energy Ions in the Magnetosphere and Near the Lunar Surface
- The Origin of the Solar System
- The Electric Potential of the Lunar Surface

Space Projects:

- Apollo Lunar Surface Experiments Package, Suprathermal Ion Detector, Principal Investigator
- Application Technology Satellite, Suprathermal Ion Detector, Principal Investigator
- Co-Investigator for numerous trapped radiation satellite experiments.

He has approximately fifty publications in Scientific and Technical Journals.

DR. GERARD K. O'NEILL

Professional Position: Professor of Physics, Princeton University

Education: B.S. - Physics, Swarthmore College, 1950
Ph.D. - Physics, Cornell University, 1954

Experience: Dr. O'Neill went to Princeton University in 1954 as an Instructor and became a Professor in 1965. His main research area is high-energy particle Physics. In 1956 he invented the storage-ring technique for colliding particle beams, a method which is now the basis for nearly every new high-energy machine. His studies on the humanization of space began in 1969 as a result of undergraduate teaching at Princeton, and were first published in 1974.

Dr. O'Neill was selected by the editors of Aviation Week as one of the Americans who contributed most to the development of the Aerospace field in the year 1975. In the 1976-77 academic year, while on sabbatical leave from Princeton, he was visiting the Massachusetts Institute of Technology as the Jerome Clarke Hunsaker Professor of Aerospace.

Contributions to the space industrialization concept by G. K. O'Neill include:

- Concept of utilization of lunar resources within present technology limits for manufacturing in space on substantial scale ("The Colonization of Space," Physics Today, September 1974).
- Mass-driver concept with supporting calculations ("The Colonization of Space," Physics Today, September 1974).
- Utility of lunar materials for construction in space of SPS ("The Colonization of Space," Physics Today, September 1974; "Space Colonies and Energy Supply to the Earth," Science, December 5, 1975).
- Directed 1976 NASA Study on "Space-Based Manufacturing from Non-Terrestrial Materials" (Space-Based Manufacturing from Non-terrestrial Materials, ed. G. K. O'Neill and B. O'Leary, Vol. 57 in Progress in Astronautics and Aeronautics, AIAA, New York, 1977).
- Directed 1977 NASA Study on "Space Manufacturing and Space Settlements" (NASA SP-428, in press).
- Principle Investigator for NASA grants studying non-terrestrial materials utilization and developing working models of mass-driver.
- Chairman, USRA Task Group on Power from Space.
- Chairman, Organizing Committees for 1974, 1975, 1977, 1979 Princeton/AIAA Conferences on Space Manufacturing/Space Settlements.
- Congressional Testimony in regard to space manufacturing.
- Award-winning book, The High Frontier, and extensive lecturing.

8.2 DR. ARNOLD'S COMMENTS

8.2.1 Significant Contributions Made by Study

The study of future developments as far-reaching as the use of lunar materials for human benefit is a difficult enterprise, as I know from experience. If a study clarifies some previously obscure points, and suggests some new and promising directions, it achieves all that can be expected. The present study has met this standard very well.

It must be considered as part of an ongoing process. Its last study task, reported in Section 7 concludes, quite appropriately, with a list of recommended tasks. I will discuss these at the end of my remarks.

8.2.2 Assessment of Study Usefulness and Applicability

The first general point I wish to make has to do with the starting assumptions. I am happy with all but two of them. There is no need to underline areas of agreement; these are the two exceptions.

First I find the restriction of assumed lunar resources to highland soil (Section 2, Guideline 6) unrealistic. As stated it is not quite rigid, and the study has interpreted it with some flexibility. Still a broader and more realistic charge would have helped. It is taken for granted in other recent studies that both mare and highland material should be available at a mining site. Not only mare-highland boundary sites (like Taurus-Littrow), but also zones of large crater ejecta from below mare layers provide candidates — there is no shortage. A serious resource survey could be confidently expected to show highland-mare-KREEP province junctions, and also the presence of unusual materials of special value. There are arguments against the presence on the moon of rich mines of copper or tin, for example. But there are no arguments against the presence of enrichments of 10-100 times in interesting elements. Indeed for Ti we know they exist. We should plan for success in areas like this. The downplaying of this aspect shows itself in Figure 6-1 on page 6-3 of Section 6. The effect of resource surveys on economics justifies earlier and greater emphasis.

Second, I find myself in disagreement with the concentration on SPS as the model product for lunar resource utilization. Indeed, at the end the authors themselves may be coming around to this. Some very early study threshold examples suggested an economic crossover to LRU at the point of perhaps 50-150 SPS units manufactured. The study final results, reported in Section 5 show nominal crossover in the range of 3-5 units, and conceivably as low as one unit. Thus the study has strengthened the

case that other smaller space manufacturing activities may justify small-scale, but immensely helpful, early investments in lunar mining and space manufacturing facilities. There are further points in this direction to be made, which rest on recent thinking by O'Neill, Criswell and others (see below). In any case I believe future studies should pay more attention to such smaller (but still perhaps quite large) projects as first steps in LRU. The idea of bootstrapping is central here.

I think we can take it that a project cost dominated by R&D at the crossover point is not in satisfactory shape. This may happen necessarily in military or national prestige projects (Apollo), but does not seem proper for an economically motivated one (unless the crossover is very early indeed).

8.2.3 Expanded Comments Concerning Dr. Arnold's Specific Areas of Interest

Cosmic-ray Shielding. There is some apparently conflicting information in the discussion and graphs in Section 4.5, pages 4-111 through 4-118. There is confusion about solar flare shielding in the report, and also in reality. As an engineering problem the flare of February 1956 was by far the worst in the record. How often do such flares occur? Can they be substantially worse? This is a research topic, and there may be some other approaches beyond waiting another 100-1000 years.

Fraction of Lunar Materials Utilized for Product Construction. The discussion is quite reasonable. One guess is that in a real project it will pass 50% quickly, and 95% much later.

Concepts B, C and D. Early in the study, Concept B acquired and maintained a lead over the others. I believe this is correct. However, the following considerations may have some influence on the implementation of this concept.

Processing on the Moon. The study pronounces against manufacturing end products, especially fragile and low-density materials, on the moon. These arguments do not apply to first-stage processing. Thus the magnetic enrichment of Fe in lunar soil, and electrostatic or other enrichment of other feedstocks, will obviously raise the value of ejected materials without substantial effect on transport costs. It may well be that fabrication of plate, coatings, or other industrial feedstocks will best be done on the moon for the same reason, and for others (see below).

Separation in Situ. Some special features of the lunar environment should be remembered. The presence everywhere of a regolith at least meters in depth, and its very low thermal conductivity in vacuum, suggest some changes from terrestrial practice. For one thing, molten lunar soil or rock may be self-contained without firebrick walls or special furnace design. A solid shell will form around the edge of the molten zone; it will tend to heal itself on cracking. Electrolyzed metal should be easily localized and recovered in such a system. Evolved solar wind gas and O₂ recovery may be more of a problem.

In such a system, metals like Mg and Al, and even other materials might best be isolated by volatilization. The large area of condensing surface required at low pressure is tolerable, if the surface is simple enough.

Electrolysis of Soil. This is a very attractive idea in principle, especially when contrasted with systems using chlorides or fluorides; however, the work performed prior to the LRU study is not really applicable. The BuMines study used more fluoride per gram recovered product, as flux, than one could possibly tolerate. Anode materials are one essential area of research: flux-free electrolysis is another. Recent work in this area by Lindstrom and Haskin (Reference 1) is an excellent beginning.

One idea, promising on paper, is to use sulfate flux, Na₂SO₄ or NaHSO₄, for lowering the melting temperature. Phosphates are another possibility. If Na, S, P minerals

can be concentrated electrostatically or otherwise, they are available locally.

I know of no part of the field where experimental work is more needed.

Heat Insulation of Lunar Soil. This suggests many other applications. In particular one can store heat in the lunar day, by heating large rocks using crude solar concentrators, or by melting lunar soil. A cover of 10 cm of soil will retain this heat through the lunar night. In a symmetric way, lunar cold can be accumulated at night and stored for daytime use. The temperature difference can be a source of power, heating and cooling of living spaces, etc. There may be no need for more technically advanced means, like power cables along latitude lines or lunar SPS's.

Lunar Volatiles. Rich resources may exist in polar shadowed regions (see my preprint "Ice in the Lunar Polar Regions"). One must not count on a resource not yet discovered. Still I believe this strengthens the case for an early lunar resource survey satellite (LPO, POLO, etc.).

Recovery of lunar sulfur seems straightforward. Nitrogen can probably be supplied as needed from implanted solar wind gas in lunar soil. Carbon and hydrogen are progressively more questionable, but should at least be recovered as byproducts wherever feasible.

Estimated H₂O Requirements. Subsection 4.4.8, page 4-84 contains the first effort ever, to my knowledge, to estimate industrial H₂O requirements. As such, it is a major contribution, even in its present rough form. It should be made more visible. It is also gratifying that the estimates come out so modest. The processes chosen in this study are probably superior in this respect, although we cannot be sure.

The requirements of H₂O for human use are easier to estimate. With proper recycling they are lower than industrial requirements.

If there is ice at the lunar poles one can consider relaxing the limits, with significant economic benefit. Agriculture is the next area to study for water demand. The University of Arizona's closed greenhouse systems for vegetable culture in arid lands provide a good benchmark.

The Food Loop. The report assumes food is provided from earth. This is properly conservative at the start, but unrealistic later. The projects for agriculture either in space or on the moon are good. Also I cannot believe that people will live without green plants -- this primitive urge can be harnessed.

Use of Lunar Glass. This has been well discussed, most recently by McKenzie in connection with the Criswell study. It must not be forgotten that the glass from lunar soil is very dark, black in any thickness, and in the basaltic range may devitrify (crystallize) all too early. Enrichment of SiO_2 and some additions of alkali would help.

On the other side, a special metal like tin may not be necessary for the float process on the moon or in space. Without corrosive gases, Fe or even Ti may serve, or Al if its volatility is not a problem.

Silica Glass. In Appendix D page D-21 of Volume III, MacKenzie is the authority for the statement that fused SiO_2 may be a practical general purpose glass. I am surprised. "Fused quartz" is such a premium product now that the very elaborate Vycor process with borates produces a much lower-priced product.

Foamed Glass. This material is emphasized, especially in Subsection 4.4.4, page 4-63. Its chief use is in SPS structural elements. For insulating purposes, lunar soil, compressed or lightly fused if necessary, can suffice. For pipes cast basalt (Criswell) may be superior.

O₂ as COTV Propellant. This idea is another of the major contributions of the study. I believe it has much to commend it, if a highly efficient process for large-scale lunar O₂ recovery can be developed. If not, the problem of high-speed solid ejecta from a mass driver engine is not quite as difficult as portrayed. If the quantum of ejected material is very small — say 10⁻⁹ g or less — it is much less dangerous. Alternatively, one might plan to eject large lumps, say > 1 kg or even more; then the probability of collision drops sharply.

Chemical Processing Systems. So far four different studies of the extractive stage have yielded four different major separation processes: carbochlorination, carbothermal (methane reduction), fluoride reactions, and direct electrolysis. This is very encouraging — when possibilities abound the technology is young. On broad grounds I favor the electrolysis system proposed here, but none of us delude ourselves that it is a sure thing, and better options may still exist.

I would strongly recommend widening the circle of workers in this area. Academic experts in extractive metallurgy are few, but they exist. This is a great area for student effort. Industrial and government technologists are more numerous, and still largely untapped:

Brian Skinner, Lee Silver and others have argued that a revitalization of these arts in terrestrial practice is necessary and inevitable. Their ideas should be sought as to how to combine efforts.

Alloying Elements. For steel Mn is no problem; the Fe/Mn ratio in lunar soil is about right. But Si, Ti, Al and Mg are likely to be much more available than more familiar alloying elements for specialty steels. Alloys using Si are already well known for magnetic use and chemical resistance (furiron). More study of alloys with these elements may be warranted.

Zone-refining. Another part of the undeveloped folklore of the field is the attractiveness of zone-refining as a unit process for purification in 1/6 g or micro-g environments, using solar heat. There should be a serious look.

Titanium. This element is widely used, and widely cursed, in the aerospace industry. The production of Ti and Ti alloy parts on earth is very difficult, and prices reflect the fact. A space or lunar environment may make it much easier (free vacuum, low or zero g). If so, and if downward transport can be made cheap, this may be one of the first large-scale space industries. Lunar ilmenite is in essentially infinite supply.

Vapor Deposited Steel Plate. I was startled to encounter this idea in Subsection 4.4.4, pages 4-57 through 4-63 (see Table 4-14, p. 4-61). Discussions with Abe Hurlich make it clear that he has some real basis to believe it is practical and economic for space utilization. If this is true, it creates great possibilities for vapor deposition as a unit process. One can develop the ideas of Henson and Drexler for composites, and even proceed to direct fabrication of parts of more complex shape, using the electron beam for removal as well as deposition. This is an excellent area for micro-processor control.

Power Requirements for Living. In subsection 4.5.2, page 4-128, power requirements per person on the lunar base are estimated at 9 kW. It is not clear whether this is capacity or average power. If the latter, it is absurdly high. Other economic drives will tend to lower area/person. Heating requirements will be very small and predictable. The mean should be an order of magnitude lower, unless power is very cheap. (9 kW/person was assumed for peak power — this is ~3 times that available in Skylab. Ed.)

Terrestrial Na_2SO_4 . This is listed in Table 4-23 on page 4-88. It would be smarter to bring terrestrial NaCl, since Cl_2 and HCl are bound to be useful, and to use lunar

sulfur for the sulfates. Terrestrial Cu could also be further substituted by lunar Al.

Asteroidal Resources. These are ignored entirely. It depends on the time scale whether this is justified. If resource utilization on a large scale is thirty years or more ahead, this is a mistake in my view (see below); in the 20-30 year period it is debatable. Here I will only remind readers that earth approaching asteroids are recoverable by known means, and that some of them surely contain very large amounts of Fe-Ni-Co metal, and of volatiles including H₂O and organic matter.

Returning Product to Earth. The study assumes, as have previous ones, that the cost of bringing material down to the earth will be comparable to the costs of bringing it up. This may not be so, as Gaffey and McCord, and Criswell, have noted. One might well use low-cost heat shields or other means, to reduce this cost drastically, to the level of manufacturing costs on earth. This is a key point; it might make all the difference in expanding the range of potential products of space manufacture.

Conclusions. I come now to a discussion focussed on the economic conclusions of the report and some related matters including the list of future tasks. I need hardly say that I am not an economist.

In the end there are two complementary statements. The front of the coin says "crossover is probably early -- perhaps about at the fourth SPS." The back reads "but the uncertainties are so great that we cannot be sure when, or even if, crossover will occur." With the addition that the range of uncertainty also includes crossover at the first unit, I must agree. However, I believe a number of factors must be mentioned on the encouraging side. The present assumption that an existing technology, such as use of Tyco ribbon-machines for growing Si, known to all to be difficult and clumsy, will be used in space, is surely conservative. The whole history of solid state materials, including solar cell manufacture, is one of rising yields, rapid process

development, and dropping costs. Any substantial reduction in the cost of any one component, however, even a tenfold drop in Si cell manufacturing cost, would probably not produce a large improvement, because this is no longer the sole driver. Still it will have significant effects, especially for earlier, smaller-scale industrial processing. I believe it can be counted on.

The M.I. T. study suggests that space transportation costs, using the present STS system, can be sharply reduced by increasing the duty cycle. I cannot evaluate this, but I must believe that the next generation of lift vehicles will incorporate advances over STS comparable to the jump from the Saturn vehicles to the Shuttle. This is another example of the general power of the learning curve.

An even more important breakthrough is now beginning in the area of "smart machines": industrial robots and teleoperators. The microprocessor revolution is well advanced, but it is just beginning to move into manufacturing. The most immediate effect will be a sharp reduction — a factor of 2 up to an order of magnitude — in the personnel requirements for space processing. Full time workers will progressively give way to a smaller number of maintenance engineers visiting periodically or at need.

All these factors, and other aspects of a general advance in technology on earth and in space, are likely to play a cumulative role. Furthermore, if one attempts the exercise of predicting the commercial airline system of the 1970's, at the time of the DC-3, one sees that the largest role on this time scale is played by the unexpected, in this case the jet engine, along with cumulative small advances in many technologies. The case is strong that more rapid advances are foreseeable now.

One last work on future tasks. The discussion above suggests that I give some items on your list special emphasis, and would add a few others. I would especially push task 29 (page 7-8) and task 8 (page 7-10). I would also note that while some, even many, of these tasks could reasonably be undertaken by the present Convair group,

with outside support in some cases, others might best be done elsewhere. I'd be glad to discuss specific suggestions at an appropriate time.

References

Lindstrom, D. J. , and Haskin, L. A. , "Electrochemistry of Lunar Rocks," Department of Earth and Planetary Sciences and McDonnell Center for Space Sciences, Washington University, St. Louis, Missouri 63130. Paper No. 79-1380, 4th Princeton AIAA Conference on Space Manufacturing, May 1979.

8.3 MR. DRIGGERS' COMMENTS

8.3.1 Significant Contributions Made by Study

The major contributions of this study can be summarized as follows:

- a. A systematic study effort of scale sufficient to lend credibility to the results was expended to examine the SPS manufacturing options. This took the concept of LRU from the domain of a few loosely coordinated investigators into that of the systematic world of aerospace. The study was accomplished impartially and in a professional manner. Much more data was generated and analyzed than is typical for a study of this size. The study manager is to be congratulated on his efficiency. All of these contributed to the worth and credibility of the output.
- b. A base of information and data on LRU has been assembled into one set of volumes and made readily available to potential investigators. Information previously scattered through many references, very obscure or completely non-existent is now compiled and organized. Although not totally exhaustive, the data bank represented by the study reports will prove an invaluable starting point.
- c. In the examination and synthesis of the data into coherent programs for comparison lies the most significant contribution of this study. The results show that any decision to pursue a solar power satellite program demonstration must logically include the LRU concept. Based on the results of this study, there appears to be no bases in logic for ignoring the LRU option. Indeed, the contrary seems

quite correct.

8.3.2 Evaluation of Study Results; Criticisms

The major shortcomings I have noted in the study are as follows:

- a. The potential for LRU in space industrialization on a scale somewhat less than that of an SPS program was not properly examined owing to certain assumptions made. Thus, data relative to much smaller lunar and space operations was not developed. Using output from this study and other sources, estimates of mass and cost were made for much smaller programs and the paper included in subsection 8.3.3 was prepared. The minimum threshold quoted in this (the GD/C) study are about 100 times greater than those indicated by the subsection 8.3.3 paper due to the assumptions used.
- b. Bootstrapping was not considered in this study. The ability of a smaller factory to make many things needed to expand to greater capacity can have significant cost impact, especially in transportation. For example, it seems quite likely that it is economically viable to use a small plant capable of manufacturing solar blankets to build the large power supplies required for full scale production. A good deal of careful thought and ingenuity needs to be expended in this area.

8.3.3 Expended Information Concerning Mr. Driggers' Specific Area of Interest.

The following paper was prepared for the Fourth Princeton/AIAA Conference of Space Manufacturing Facilities, held in Princeton, New Jersey during May 14 through 17, 1979. The paper is entitled "Is Lunar Material Use Practical in a Non-SPS Scenario?", and is paper number 79-1414.

1

2

3

IS LUNAR MATERIAL USE PRACTICAL IN A NON-SPS SCENARIO?

Gerald W. Driggers*
Southern Research Institute
Birmingham, Alabama

Abstract

The issue of material quantity requirements in Earth orbit which make lunar material use competitive with classical transport techniques is examined. Scenarios of future raw and finished material needs in orbit as a function of Earth-based market potential are presented. Cost of transportation from Earth and cost of a lunar-based industry to satisfy these markets are addressed and compared. An absolute minimum mass requirement and lunar materials implementation cost are not identified; however, the thresholds are shown to be between 10 and 100 times less than previously believed. The key technology needs over the next decade, and possible scenarios leading to use of lunar materials in the 1990's are discussed.

Introduction

Since the publication of O'Neill's classic paper (1974) on lunar materials (LM) utilization for construction in Earth orbit, the threshold of practicality for such use has been at issue.¹ Such a threshold had been previously examined by both Ehricke and researchers at the NASA/Ames Research Center regarding the supply of raw materials for the Earth. More recently, comparisons have been done between very large scale programs involving Solar Power Satellite (SPS) construction in space.^{2,3} For Earth use of raw materials it was generally concluded that a lunar based industry could not compete with an Earth based except in a situation of great need and great scarcity. Studies on SPS have shown thresholds of one to thirty units on cost equivalency between terrestrial and non-terrestrial materials.^{2,3} Orbital activities on a scale significantly smaller than SPS have not previously been examined in a systematic way.

The practicality of using lunar materials in space depends on several factors: the technology of obtaining and converting the raw material; the potential existence of a market sufficiently large to warrant the investment; and the capability to compete favorably against an Earth-based industry. Sufficient study, experimentation and exploration have been accomplished to establish that the necessary technological goals are achievable. Practicality thus

depends on the projected markets and potential for competitiveness. These are the areas addressed in a recent, brief study effort, the results of which are presented in this paper.

Projected Earth Orbit Materials Market

The fundamental data for establishing the potential range of materials required was compiled during two studies conducted for NASA.^{4,5} These parallel contracts resulted in two complementary reports on the future of Space Industrialization (SI). In these studies the focus was on how industry may utilize space during the 1980 to 2010 time period as driven by the market place, international affairs, national and worldwide economics and technology. Four generic categories of industrial activity were examined: Information; Materials (or Products); Energy; and People (travel, entertainment, etc.) Figure 1 lists some activities that fall under the first three of these categories. Also listed are several scientific initiatives which would possibly benefit from a lunar materials utilization capability. The latter are not considered as representative of any projectable market, however.

SCIENCE	INDUSTRY		
	INFORMATION	ENERGY	MATERIALS
RADIO ASTRONOMY	COMMUNICATIONS	SATELLITE POWER SYSTEM	RAW MATERIALS
SETI	- PERSONAL TELECONF.	ILLUMINATION	MANUFACTURING STOCK
LARGE OPTICS	- BROADCAST TV	- LUNETTA	SEMICONDUCTORS
MISSION SUPPORT	- NAT'L INFO SERVICE	- SOLETTA	SOLAR CELLS
- LARGE DEEP SPACE	- SENSOR POLLING	MICROWAVE REFLECTOR	STRUCTURES
- LARGE PLANETARY	NAVIGATION	FUSION IN ORBIT	LO ₂ SUPPLY
- LARGE MANNED PLANETARY	- LAND	NUCLEAR WASTE DISPOSAL	
- LUNAR BASE	- SEA		
- ASTEROID & COMET MISSIONS	PERSONAL		
ISOLATED RESEARCH FACILITY	GEO. PLATFORM		
ECO SYSTEMS RESEARCH FACILITY	REMOTE SENSING		

Figure 1: Examples of Potential Applications of Lunar Materials to Science and Industry Initiatives

Of the three industrial areas on Figure 1, these labeled Information and Materials are considered to have the best existing foundation in experience and technology. During the SI studies a substantial effort was expended to characterize these markets using hard data on existing demand and appropriate industry projections. Given a framework of technological development, economic development and appropriate

*Head, Applied Thermal Section; Member, AIAA.

government/industry cooperation and investment, these market surveys were used to project total business revenues. Selected projections are illustrated in Figure 2.

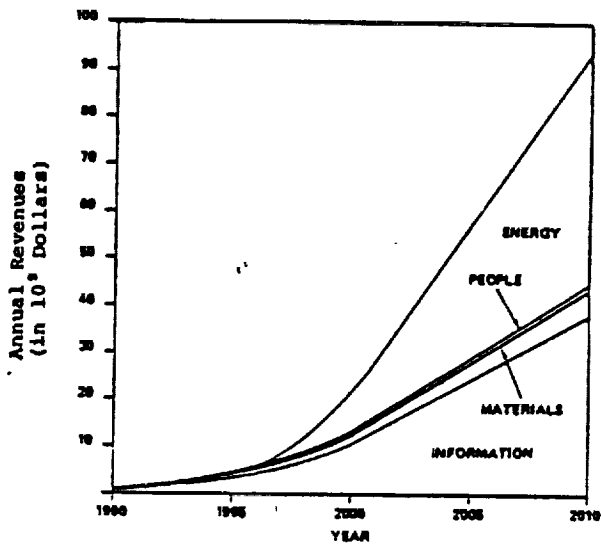
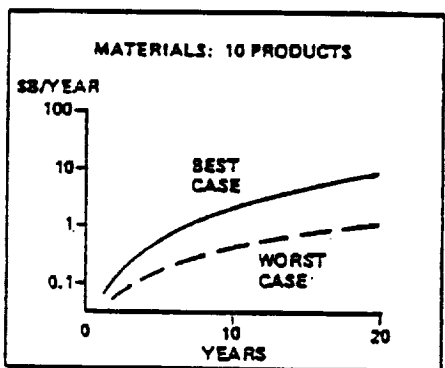
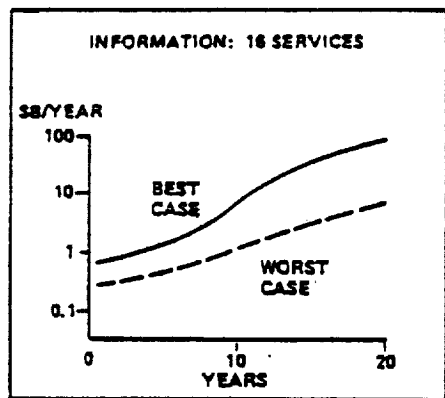

Figure 2: Example of the Revenue Data Compiled During the Space Industrialization Study. This type data equates to demand and use and leads directly to the type data presented in Figure 3

The business data represented by Figure 2 was subsequently converted to satellite (in the case of Information initiatives) and partially processed

materials requirements. A requirement scenario based on classic market buildup and penetration assumptions in communications is illustrated on Figure 3. In the materials area, four specific high value products representative of the types of products anticipated for processing or production in space were selected and market projections made. Various assumptions were then applied to the percentage of this market ultimately captured by space products based on individual evaluations of possible value added by space.

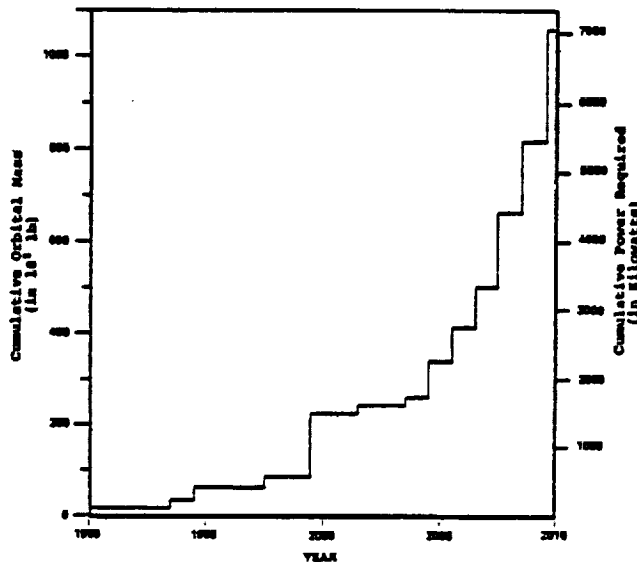

Figure 3: One Example of the Evolutionary Mass and Power Requirements at Geosynchronous Orbit Generated by Selected Initiatives

These total market and penetration projections based on industry data provided the basis for projecting raw material needs in orbit. Projections were also made on the possible range of geosynchronous satellite (GeoSat) business in terms of total mass vs. time and location in Earth orbit were compiled. For purposes of the current study an evaluation of the percentage of this total requirement deemed compatible with lunar materials was made. The projections were constrained to the period of 1990 to 2010. Figure 4 presents the total demand projected as a function of market assumptions. Note that although GeoSat Information revenues were several times those of materials in Figure 2, the mass requirements are dominated by the products projections.

There are two reasons for the noted difference. First, the GeoSat mass is in finished, functioning product, obviously of higher value than the raw material being supplied a processing plant in Earth orbit. Secondly, pound-for-pound the GeoSat represents a significantly higher intrinsic revenue potential over its life span. Conversely, one would be willing to spend significantly more to obtain finished

government/industry cooperation and investment, these market surveys were used to project total business revenues. Selected projections are illustrated in Figure 2.

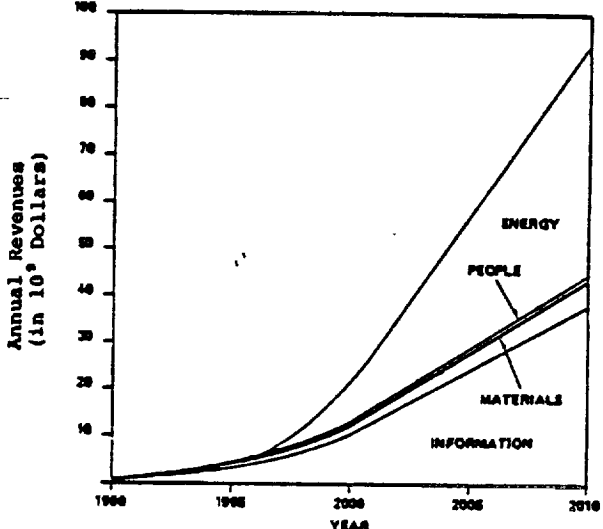
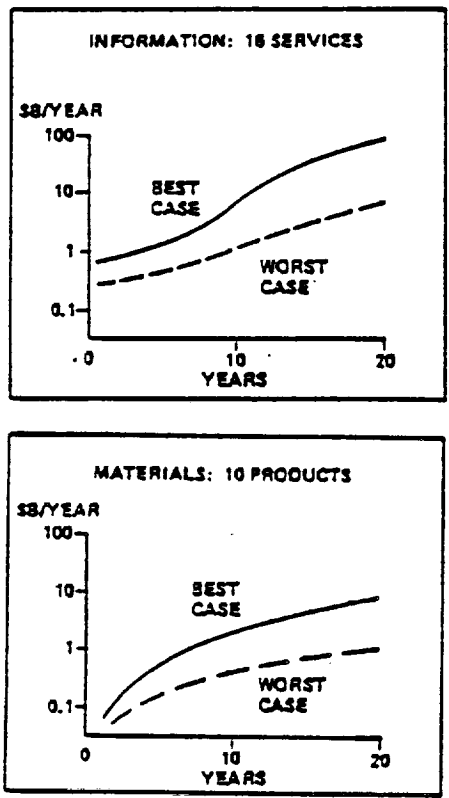

Figure 2: Example of the Revenue Data Compiled During the Space Industrialization Study. This type data equates to demand and use and leads directly to the type data presented in Figure 3

The business data represented by Figure 2 was subsequently converted to satellite (in the case of Information initiatives) and partially processed

materials requirements. A requirement scenario based on classic market buildup and penetration assumptions in communications is illustrated on Figure 3. In the materials area, four specific high value products representative of the types of products anticipated for processing or production in space were selected and market projections made. Various assumptions were then applied to the percentage of this market ultimately captured by space products based on individual evaluations of possible value added by space.

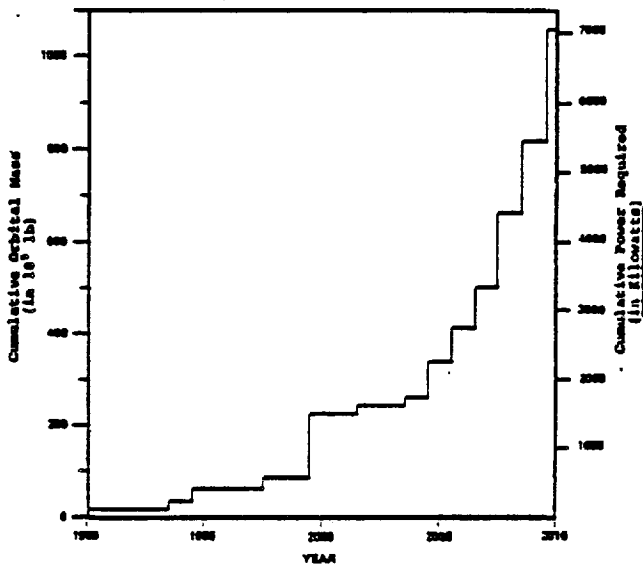

Figure 3: One Example of the Evolutionary Mass and Power Requirements at Geosynchronous Orbit Generated by Selected Initiatives

These total market and penetration projections based on industry data provided the basis for projecting raw material needs in orbit. Projections were also made on the possible range of geosynchronous satellite (GeoSat) business in terms of total mass in orbit. Thus, projections of total mass vs. time and location in Earth orbit were compiled. For purposes of the current study an evaluation of the percentage of this total requirement deemed compatible with lunar materials was made. The projections were constrained to the period of 1990 to 2010. Figure 4 presents the total demand projected as a function of market assumptions. Note that although GeoSat Information revenues were several times those of materials in Figure 2, the mass requirements are dominated by the products projections.

There are two reasons for the noted difference. First, the GeoSat mass is in finished, functioning product, obviously of higher value than the raw material being supplied a processing plant in Earth orbit. Secondly, pound-for-pound the GeoSat represents a significantly higher intrinsic revenue potential over its life span. Conversely, one would be willing to spend significantly more to obtain finished

GeoSat parts in high Earth orbit (HEO) than to obtain unprocessed material in low Earth orbit (LEO).

purposes of the present study the three projections were sufficient to compare Earth based vs. lunar based material supply.

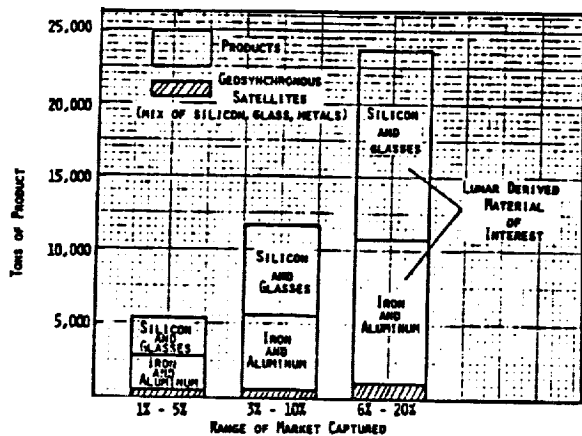

Figure 4: Possible Demand for Lunar Materials Based on Level of Market Satisfied by Space Utilization Between 1990 and 2010

The data of Figure 4 are presented in Figure 5 varying with time between 1990 and 2010. The apparent Sigmoidal behavior of the curves is driven by the use of classical market penetration and capture assumptions. The upturn after about 2006 is driven by the rising dominance of GeoSat markets not projected to saturate by 2010. Historically, the opening of a new economic operating regime has resulted in growth more along the dashed line path shown in Figure 5.

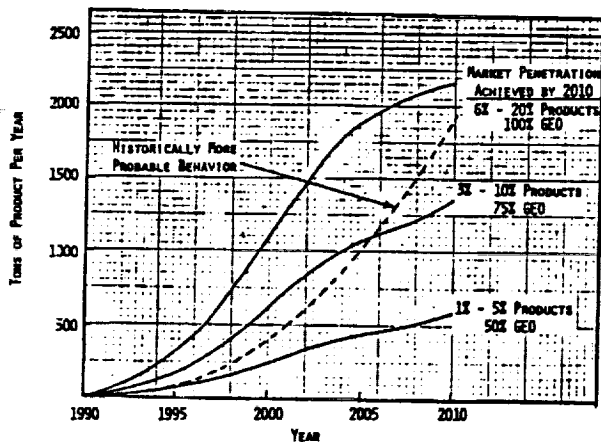

Figure 5: Possible Demand for Lunar Materials Based on Proportion of Specific Commercial Markets Captured by Space Based Products and Services

The limitations inherent to the theory and assumptions underlying the three projections shown make prediction of the historical type curve impossible. A broader base of product and market characterization would be required to begin to approach such a projection. Although it may be possible to gather such data it has not been accomplished to present. For

Cost of Materials Transport from Earth

The total cost to provide transportation to LEO and GEO at any point in time for the three scenarios of Figure 5 is dependent on three things. First, the Design, Development, Test and Engineering (DDT & E) cost to provide a capability such as increased mass per launch or reduced cost per ton of payload in orbit. Second, the cost of procuring sufficient vehicles to handle the traffic during the peak launch year. Third, the operations, expendables and refurbishment costs which occur due to launch of payloads.

A national decision to embark on the usually expensive and rather risk-laden venture of launch system development is typically driven by a combination of economic tradeoffs and political perceptions. In the development of space industry the economic driver will be dominant over all but technological considerations. No foreseeable single program or set of government programs will provide justification for a successor to the Space Shuttle until the nineties or beyond.

However, since this study addressed the practicality of establishing a single materials industry in space (perhaps composed of several elements) it was appropriate to examine a range of vehicle combinations with potentially lower operating costs than the Shuttle and Shuttle/Inertial Upper Stage (IUS). The costs for DDT & E, procurement and operations used in this study were compiled by NASA over the past three years during studies of Shuttle growth and new hardware development. The vehicles considered were:

Earth Launch

1. Basic Space Shuttle (65,000 lb LEO)
2. Growth Shuttle (100,000 lb LEO)
3. Class II Heavy Lift Launch Vehicle (HLLV, 350,000 lb LEO)
4. Class IV HLLV (600,000 lb LEO)

Orbit Transfer

1. Fully Reusable Orbit Transfer Vehicle

The cost for the total transportation requirements of the three 20 year programs outlined above were computed using the unit transport costs shown on Figure 6. These values were arrived at by consideration of such parameters as true load factor (gross capability minus shipping container for example for raw materials).

The results of the total cost evaluations are presented on Figure 6 for each vehicle combination presented. Although a non-linearity is surely present, the data at 5420 tons (the minimum program) are connected to the DDT & E costs by a straight

dashed line to estimate cost in that regime. Several observations can be made from the data presented.

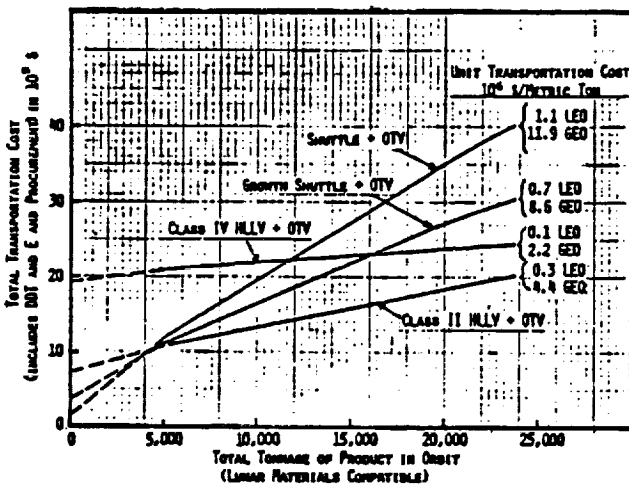

Figure 6: Transportation Cost as a Function of Total Required Tonnage in the Market Scenarios

Since the two Shuttle and the Class II HLLV lines cross within a very narrow tonnage span it probably never makes economic sense to invest in a growth Shuttle system for this transportation job if the Class II HLLV investment can be made. If Class II is not to be built, then the growth shuttle makes sense beyond about the 4000 ton requirement. Implementation of the Class II HLLV assumes extensive use of existing facilities. The Class IV HLLV is too large a step for the level of programs being examined here due to the very large investment required in DDT and E and all types of new manufacturing, handling, launch and recovery facilities.

At the lower end of the market scenario the Shuttle plus OTV probably represent the best option while the Class II HLLV plus OTV is clearly superior at the higher tonnage rates.

Lunar Materials Scenarios

Making the comparison between Earth based and lunar derived materials required development of an operational scenario for obtaining, transporting and processing the raw materials. Time and resources did not allow a detailed evolutionary scenario to be developed for all three demand curves of Figure 5. Some tradeoffs were made at the lower total demand level and assumed to apply in the other two cases. A specific example was the evaluation of raw material transport modes. Since the fuel (liquid Hydrogen) for a chemical system was assumed to come entirely from Earth, it was advantageous to use a small Mass Driver system as defined by O'Neill to project ore stock from the Moon to a "catcher".⁶ Surprisingly, this proved advantageous even at the lowest demand level examined (5420 Tons of products

over 20 years). Also, as has happened repeatedly in other studies, the placement and operation of the chemical processing plant in space vs. on the lunar surface again seemed advantageous. This was partially driven by the real value assigned "slag" based on its usefulness as radiation shielding.

The capability requirements of the individual components of the operational system were determined during initial phases and the first installations sized accordingly. For example, the materials process plant in the low scenarios was sized to be in full operation by about 2010, operating intermittently or at reduced capacity from 1990 through 2009. Capacity was incremented according to Figure 5 beyond 2000. The remaining two demand curves were satisfied similarly using the basic modular unit of the low scenario.

The lunar operations were sized based on a Mass Driver capable of meeting peak year demands and operating intermittently or at reduced capacity during prior years. Inefficiency in sizing for the early years is probably compensated by the reduced cost of operations since no people require support during extended shut downs.

The manufacturing plant is not required by GeoSat demand until about 1998. The production rate grows rather rapidly after that, however (see Figure 3). A modular system was again assumed with a factor of four growth by 2007.

For transportation, lunar oxygen extracted on the surface of the Moon and at the processing plant was used extensively for both chemical and electric propulsion.³ No Earth launch system beyond the presently defined space shuttle was assumed through the entire operations period. All hydrogen, nitrogen and process plant make-up reagents were transported from Earth. All food and H₂ to make water for all crews was also assumed hauled from Earth although a simple water recovery system was assumed.

Thus the following represent the elements of the space materials and component production facility:

1. Transportation

- Space Shuttle to LEO
- LOX/H₂ POTV for passenger orbital transport
- LOX/H₂ LTV for lunar surface transport
- LOX COTV for hauling cargo between orbits
- Mass Driver to eject ores from the Moon

2. Facilities

- Lunar mining and bagging
 - Lunar habitat
 - Mass catcher
 - Chemical Process Plant
 - Manufacturing Plant (post - 1998)
 - Space habitat
 - LOX plant and depot (lunar surface and orbit)
- (Traffic levels for the three demand scenarios do not warrant way stations at LEO or lunar orbit.)

The initiation and build-up scenario for the low demand projection proceeds as follows:

- A. Twelve shuttle flights lift 300 tons to LEO over a few months span. Unmanned cargo flights transport 35 tons to the selected lunar mining site. Two crew modules of eight personnel each land at site.
- B. Crew of 16 assembles and activates mining operation over 60 day period (Mass Driver pacing item). Bury two crew modules for extended use. All structure and systems designed for maximum re-use or canabilization. Once system is operational, 12 return to Earth and regular crew of four remain to operate and maintain automated system for six months.
- C. Capture MD output and transport to processing plant.
- D. Shut down lunar operation for five years and run system off initial accumulation or operate the mine for short periods annually.
- E. Parallel to A. and B. deploy a processing plant capable of ultimately achieving 600T/year output products. The unit would weigh about 10 tons with a 10 ton, 500 kw power supply.^{7,8} A crew of six would operate and maintain the system during intermittent operating periods from 1990 to 2001. After 2001 the crew would be full time. (The ultimate capacity of the other two scenarios require a 45 ton, 1.5 Mw and a 90 ton, 3 Mw plant with crews of 8 and 10 respectively. About two shuttle flights required to deploy.
- F. Rotate all crews on a six month basis and use a O-g habitat at the processing/manufacturing habitat.
- G. Deploy a 40T/year output plant of about 17 tons mass in 1997. Begin full scale operations in 1998-1999 time frame. Total capability is incremented in 40T/year output increments to about 160T/year in 2010. Six people are required for the basic

unit operating full time; 12 for the 2010 operation level. The mid and upper scenarios used 50T/year and 80T/year capacity plants as the fundamental module.

All data for the sizing of facilities and transport systems came from recently published reports, briefings or draft reports on lunar materials, lunar material utilization or transportation systems.^{3,4,5,6,7,9} The degree of automation assumed is not beyond the current state-of-the-art and should be very commonly used by the latter eighties.

Cost of Lunar Materials

The individual scenarios described above were costed using data from references 3, 4, 5, 7 and 9 and some factors derived from fundamental data such as shuttle transportation operations costs. The break down of cost element as a function of demand scenario is given in Table 1.

Table 1
Cost of Obtaining Lunar Materials

Cost Element	Demand Scenario		
	LOW	MID	UPPER
A. DDT & E			
+ Procurement			
Lunar			
Power Station	0.280	0.300	0.500
*Habitat	0.800	1.000	1.200
(const. + St. State)			
Mining Equipment	0.005	0.005	0.005
Benef. Equipment	0.005	0.005	0.005
Propellant Depot	0.020	0.025	0.035
	1.110	1.335	1.745
Space			
Power Station	0.500	0.800	1.500
*Habitat			
(Proc. & Man.)	0.800	1.000	1.200
Process Facility	0.500	0.600	0.700
Prop. Facility	0.080	0.080	0.080
	1.880	2.480	3.480
Facility Activation			
Transport	0.375	0.525	0.775
Crews	0.001	0.001	0.001
Misc.	0.010	0.010	0.010
	0.386	0.536	0.786
Transportation			
POTV	1.500	1.500	1.500
COTV	1.500	1.750	1.900
PLTV	0.400	0.400	0.400
Mass Driver	0.250	0.250	0.250
Mass Catcher	0.500	0.500	0.600
	4.150	4.400	4.650

*Costs shared between habitats.

Table 2 (continued)

	LOW	MID	UPPER
B. Operations (20 yr.)			
Shuttle	0.768	0.957	1.211
Lunar Facility	0.020	0.020	0.040
Lunar Trans.	0.040	0.040	0.060
Space Crews	0.018	0.020	0.025
Space Facility	0.010	0.015	0.030
Transportation (OTO)	<u>0.100</u>	<u>0.191</u>	<u>0.382</u>
	0.956	1.243	1.748
Totals (No Operations)	7.526	8.751	10.661
Total (inc. Operations)	8.482	9.994	12.409
C. Manuf. Facility Costs			
DDT & E +			
Procurement	0.740	0.900	1.200
Power Station			
(Share Proc. Plant)	0.100	0.120	0.200
Facility Activation	<u>0.050</u>	<u>0.050</u>	<u>0.075</u>
	0.890	1.070	1.475
Operations (12 yr.)			
Shuttle +			
Transportation	0.400	0.535	0.700
Facility	<u>0.006</u>	<u>0.008</u>	<u>0.012</u>
	0.406	0.543	0.712

Sufficient detailed study has not been done to establish whether any of these numbers have absolute validity. Real experience could be higher or lower based on several assumptions. There is some data base in study and design activities as a foundation for these estimates, however, and they should serve the present purpose.

The results of the costing can be summarized as follows.

Cost for 20 years of raw material supply processed to a purity and state sufficient for feed-stock to a Materials Space Processing Facility:

Low Demand Scenario = 8.482×10^9 \$
 Middle Demand Scenario = 9.994×10^9 \$
 Upper Demand Scenario = 12.409×10^9 \$

Investment and Operations to manufacture structure, power systems, antennae, etc. for large GEO-SAT assembly:

Low = 1.296×10^9 \$
 Middle = 1.613×10^9 \$
 Upper = 2.187×10^9 \$

The production cost of raw materials then calculates as follows for the various demands:

Low = 0.176×10^6 \$/Ton (\$80/lb)
 Middle = 0.106×10^6 \$/Ton (\$48/lb)
 Upper = 0.074×10^6 \$/Ton (\$34/lb)

The production cost of satellite and power system hardware is also:

Low = 0.972×10^6 \$/Ton (\$440/lb)
 Middle = 0.904×10^6 \$/Ton (\$410/lb)
 Upper = 0.772×10^6 \$/Ton (\$350/lb)

The cost of raw materials and satellite components including amortization of investment is a more complex assessment. The results are very sensitive to the period of amortization and the level of activity during that period. For purposes of the comparison being done in this study no attempt was made to extend the 20 year span of analysis to address the implications of, for example, a 30 year period of amortization.

Cost Practicality Thresholds

The cost for transportation from Earth of the total demand tonnage is compared to the cost of utilizing lunar materials in Figure 7. On the basis of simple integrated cost over the 20 year span in constant 1979 dollars the lunar option is lowest for all three scenarios examined. Cross-overs occur at less than 4000 tons for the Shuttle based options.

Figure 7 does not address the economic issues associated with the various options for material supply. When such considerations are made, the initial investment for both the lunar option and the Class II HLLV + OTV will drive the integrated cost curves upward. Such an economic examination should not change the basic ordering of the results shown, considering the spread of values.

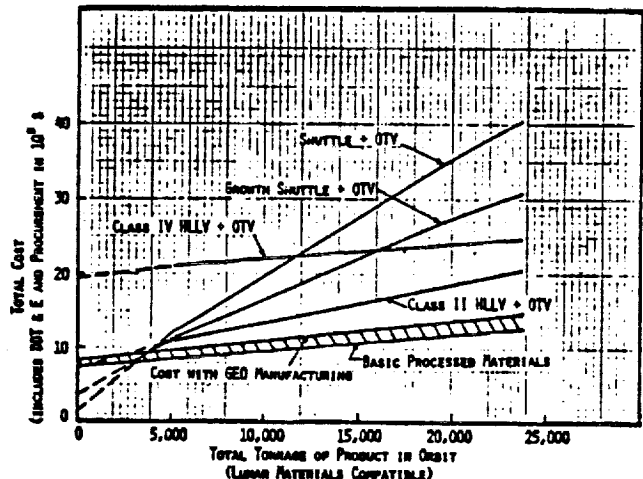

Figure 7: Comparison of Transportation Cost Options to the Lunar Materials Option

In dealing with any overall economic assessment, however, other factors should be taken into consideration. For example, the growth of space industry to the levels implied here for post-2000 may not occur unless a more economic mechanism than Earth launch for material supply are found. The minimal cost per pound for lunar material has not been identified in this study; only a rather simple set of comparisons made. The levels of activities envisioned for SI without SPS will never justify the very large Class IV plus vehicles potentially capable of less than 0.11×10^6 \$/ton (\$50/lb) to Earth orbit. Unit costs below this threshold appear feasible with an

efficient system to obtain lunar materials at these lower quantities. Very large scale Materials Space Processing may depend upon achieving such goals.

The cost of operations at geosynchronous orbit for the large Information initiatives must be considered in an economic assessment also. A lunar utilization industry provides the basics for such an operation by definition, whereas the habitat DDT & E and operational capability costs must be added to the transportation options shown on Figure 7. Also, the existence of a good supply of very cheap shielding material is not inconsequential when considering operational modes for manned geosynchronous operations.

Key Technologies

A great deal of work needs to be done on several technologies which directly affect cost and efficiency for obtaining and using lunar materials. A few of these are compiled in the following list.

Transportation

POTV - Develop a capability to transfer personnel and payloads to geo. and lunar orbit and return. All the chemical propulsion and life support technologies are basically state-of-the-art.

COTV - Develop the technology and demonstrate the feasibility of using oxygen as a propellant in a high efficiency, high reliability ion drive engine. Some fundamental research and demonstration work can be done relatively inexpensively to seek out and solve problems pursuant to building scaled-up hardware.

LTV - Begin tradeoffs and preliminary design studies related to defining a minimum cost LTV suitable for passenger transport to and from the Moon with extended, untended loiter time in lunar orbit. Two options should be studied: a passenger only and a passenger plus cargo down, passenger up. Examination of inexpensively hard landed or semi-soft landed supplies (a la Clarke and Smith, circa 1954) should be examined.

Mass Driver

- Continue the development work at Princeton leading to detailed designs; operation under simulated lunar conditions; maximized efficiency for mass; optimal modularization; etc. Such ancillary issues as techniques for long term containment and maintenance of liquid and gaseous helium should be identified early to enable suitable research efforts to begin. Demonstrate the

minimal manpower required for deployment of a Mass Driver.

Facilities

Lunar Mining and Bagging

- Begin preliminary design studies on a minimal, modularized and high automated facility. Design and do scale demonstration of equipment and techniques for handling lunar materials (particularly fines). Design and do scale demonstration on the manufacture of fiber glass and woven bags. Design an automated system suitable for MD loading at various rates. Design a surface mining system capable of handling the fines and rubble.

Lunar Habitat

- Design a minimal habitat suitable for short-term (60 days) occupancy by 8-10 people and long term (6 months) occupancy by 2-4 people. Should be transportable from Earth orbit as a single unit and "suitable for burial" on the lunar surface for protection.

Mass Catcher

- Design a minimal system capable of intercepting and transporting or handing over 10 to 100 tons of bagged lunar material. The key technological needs of such a system should result from this preliminary design so that research efforts may commence where necessary.

Chemical Process Plant

- Demonstrate the capability in the laboratory to extract oxygen and desired metals from simulated lunar material using the three or four most promising techniques previously studied. Using criteria developed during these demonstrations, select one route and do a detailed plant design to obtain more insight into technology needs. Phase research accordingly.

Manufacturing Plant

- More rapid development of geo based services may occur than predicted in this study. Studies to identify specific manufacturing machine needs leading to preliminary design of such machines should be conducted.

Space Habitat

- Design a minimal suitable 0-g habitat for 6-10 people capable of growth and shuttle compatible should be defined with the use intended here in mind. Previous detailed studies for LEO space stations of similar size may provide a good starting point.

LOX Plant and Depot

- Preliminary design of a plant and depot along with research and demonstration of techniques for extracting O₂ from lunar soil. Design of a light weight, automated plant complete with raw material gathering, liquefaction and storage capacity is required.

Site Selection

- Lunar - Detailed study of the lunar surface and trajectories for ejected bags form the minimal basis for mining and MD site selection. An automated inspection capability ultimately may be required.
- Space - The optimal siting of the materials processing and manufacturing plants should be evaluated as a function of costs associated with all transport functions.

Market Development

Materials and Products

- Extensive ground based study and research and space based experimentation and demonstration will be required to develop the unique products of sufficiently high value to warrant building plants of the scale discussed here. An aggressive set of programs directed toward developing a set of such products compatible with lunar materials is required. Obviously experimental work involving silicon, silica, glasses, aluminum iron and steel would be of value. The use of inexpensive "Get-a-Way" specials can become a key to this work.

Satellites

- Develop the sub-set technology areas of large power systems (50Kw to 10Mw), large structures, control and antennae design. Work in these areas is in progress and should be promoted aggressively in the eighties to assure industry investment and operational capability development in the nineties.

Near-Term Programs

Power Systems

- NASA and industry should actively promote development of free-flying power systems beginning with the 25-50Kw module currently being considered. A continuing program leading to development of systems with continuous output on the order of one to ten megawatts should be pursued.

Large Space Structures

- Research and development in efficient fastening and assembly, control, and material sciences (especially long term exposure

response) should be aggressively pursued in the eighties.

Orbit Transfer Vehicle

- A manned geosynchronous orbit capability is the next major step in extending our reach into space. The system should be designed and developed with the lunar mission discussed in this paper as part of the criteria. Availability by 1988-1990 would seem most appropriate.

Solar Electric Propulsion System (SEPS)

- Develop and utilize a SEPS capability using 25 to 50Kw as a minimum during eighties. Pursue program expansion to larger power systems and develop oxygen propellant technology.

Materials Space Processing

- Expand the current program to allow involvement of greater numbers of experimenters and payloads in the early eighties. Steadily promote the increased involvement of industry in joint endeavors with government to make commercial activities feasible.

Communications Satellite Technology

- Promote a coherent technology base suitable for providing the necessary state-of-the-art in the 1990s leading to large scale, high power systems.

Evolutionary Scenarios

The development of an industrial base in space similar to the scenarios discussed previously will depend strongly on co-operative arrangements worked out between elements of government and industry. These arrangements will be particularly important during the early to mid-eighties when risks, uncertainties and pay-back periods make private investment almost impossible. Current NASA and Congressional efforts to promote commercial applications of the Space Shuttle are a strong, positive step in the direction of meaningful joint endeavors.

If risk-sharing arrangements on R & D can be arrived at, it seems quite likely that the fundamental markets will begin to develop. At that point sufficient knowledge will be in hand to encourage multiple industries to make investments against reasonable use guarantees. That is, User A assures, guarantees, or warrants Supplier B that his product will be used at some minimal price and quantity. Of course, the first User is ultimately the consumer of goods or services, and careful, in-depth market research work is an absolute must. However, once the market is sufficiently characterized, the proper agreements can begin to fall into place through the ultimate supplier of raw material. Of course,

if the necessary investment in new R & D and equipment can be shown to be sufficiently small, one corporation and/or investor might be attracted to establishing the entire set of systems and facilities. It seems more likely that the development of individual elements of the industrial system will evolve similar to the more segmented historical Earth based approach which distributes risk during initial phases. The ultimate relationships of the various parties involved in a mature space industrial system (as defined by this paper) are presented in one form in Figure 8.

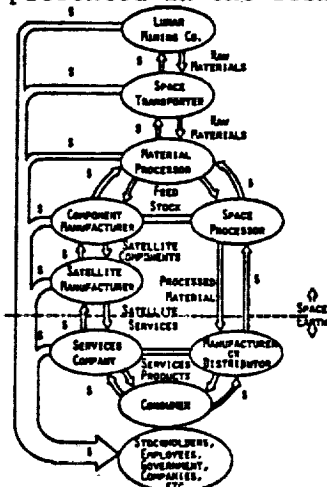

Figure 8: Various Relationships Necessary for a Mature Space Industry (as discussed in this paper) to exist

Although this study examined the period 1990 to 2010 based on previously existing data it unfortunately appears unlikely that a lunar materials base industry can evolve rapidly enough to be in operation by 1990. The constraints are not technological as related to development of techniques, hardware or software. They are technological in the sense that the true potential for generating high value products and large communications systems that have markets must be determined. Thus the results of Materials Space Processing experiments and market development in the 1980 to 1990 time period will be crucial as will the large GeoSat initiatives. The earlier a uniqueness is established for certain products and the market determined for large satellites, the sooner will begin the drive to obtain the products and services at the least possible cost. Modest investments in the early eighties to promote the lunar materials utilization technologies can result in scientific advancement, application of technology to other needs and take years off the ultimate implementation time.

In the immediate future the following should be done.

1. Define a set of Materials Space Processing Experiments oriented toward development of new materials technologies using lunar compatible feed stock.

2. Locate and reserve payload space ("Getaway Specials") on the earliest possible shuttle flights such that experiments defined in Item 1 can be accomplished. Several will probably be required.
3. Define dual applications where possible for the scientific knowledge and engineering know-how to be gained due to R & D of the key technologies previously discussed.
4. Promote the early R & D initiatives based on Item 3.
5. Develop a communication medium suitable for dissemination of results on Items 1 through 4 on the order of the British Interplanetary Society Journal.

Several other steps to be taken in the near term will require subtle interfacing between political and social elements to establish the environment within which technology can flourish.

Conclusions

Lunar materials utilization can probably compete against the advanced launch systems for operation of a reasonable set of space industries. Unless significantly cheaper approaches to advanced launch systems are defined it may be that such industry growth can be enhanced by lunar materials use. The use of lunar resources in these scenarios is uncertain, however, until certain basic research and development in materials space processing and large communications systems is accomplished in the early to mid-eighties.

References

- ¹O'Neill, G. K., "The Colonization of Space," *Physics Today* 27, 9, 1974, pp. 32-40+.
- ²Space-Based Manufacturing From Non-terrestrial Materials, Progress in Astronautics and Aeronautics, Vol. 57, AIAA, 1977.
- ³Lunar Resources Utilization for Space Construction - Final Report, NASA Contract NAS9-15560, General Dynamics/Convair Division, 1979.
- ⁴Space Industrialization Study - Final Report, NASA Contract NAS8-32197, Science Applications, Inc., April, 1978.
- ⁵Space Industrialization - Final Report, NASA Contract NAS8-32198, Rockwell International/Space Division, April, 1978.
- ⁶Proceedings of the "Meeting on the Scaling of Early Lunar Operations Leading to Full-Scale Space Industrialization", (In Press) University of California, San Diego, January, 1979.
- ⁷Extraterrestrial Materials Processing and Construction - Final Report, NASA Contract NAS09-051-001 (Mod #24), Lunar and Planetary Institute, September, 1978.

¹Waldron, R. D., Erstfeld, T. E. and Criswell, D. R. "The Role of Chemical Engineering in Space Manufacturing", Chemical Engineering, February, 1979, pp. 80-94.

²"Manned Geosynchronous Mission Requirements and Systems Analysis Study - Mid-Term Review Phase I", Grumman Aerospace, February, 1979.

8.4 DR. DULA'S COMMENTS

8.4.1 Significant Contributions Made by this Study. If the U.S. maintains its leadership in the use of space for the benefit of all humanity, it will have to build and use larger structures than have been necessary in the past. No one today has a broad enough conceptual framework or sufficient facts to think usefully about how and when the U.S. might use extraterrestrial resources to help build these large space structures. This study is a useful first attempt to compare, with some precision, the costs and benefits of using lunar resources to construct space structures. NASA must evaluate, insofar as evaluation is possible at this time, the tradeoffs involved in using these resources in space construction. The study's chief benefit, in my mind, is that it allows future planners within the U.S. space program to develop a broader conceptual framework. This broader framework will result in the development of new methods of using space for the benefit of the American people over the next several decades.

The study also contributes to our understanding of how a specific large space structure, the Solar Power Satellite, might be built with some lunar-derived materials. Regardless of the practicality of this solar power project, study methodology developed to deal with specific requirements in a specific program will be useful to evaluate the costs and benefits of using lunar materials for any large structure built in space. The sensitivity and uncertainty analysis regimes developed to deal with multiple hierarchical uncertainties in this report can be used to study any complex technical problem whose evaluation requires dealing with many unknowns. Our society increasingly relies on this type of multivariant analysis to make important policy decisions. Advanced space activities, such as the present study and especially its specific focus on the solar power satellite, provide a model system for development of an analytic regime for making decisions based on incomplete present knowledge.

Finally, this type of study shows that at least some elements of the American public sector are looking a significant distance into the future. So much government planning focuses on what is small and trivial. It seems fit that we occasionally take the advice of an anonymous writer who said, "Make no little plans. They have no fire to stir men's souls. Reach only for the stars."

8.4.2 Assessment of Study Usefulness and Applicability.

The usefulness and applicability of this study could be increased by making the conclusions of the report understandable to the average American and by studying the nature of the legal risk the United States would assume if it used lunar resources for space construction.

As a legal manager primarily concerned with evaluating high technology proposals and studies (though admittedly not aerospace studies) I have been very impressed with the depth and breadth of this study. The study's very technical sophistication, however, gives rise to my only two thoughts on how it might be made more useful. First, it is not easily read by one unskilled in technology. One of the most important jobs of a good technical manager is to allow policymakers the option, if they wish, of going to the source documents, such as this study, and understanding the arguments they present. It should be stressed that this goal is rarely achieved. It is extremely difficult. Most technical writing is precise and uses a language strange to those not studied in the art to which it pertains. I suggest that the final report incorporate an Executive Summary written in such a way that the average member of Congress, policymaker at NASA, or private citizen could read and clearly understand it.

Secondly, any investment decision made by a large company stands on a tripod. The industrial decisionmaker must evaluate technical, economic and legal feasibility before entering a venture. It avails not at all that a project would be technically possible and financially lucrative if it is illegal. Unfortunately the present study

stands on only two legs, technical and economic. The use of extraterrestrial resources, especially lunar-derived resources, is a subject of ongoing legal debate within the Committee on the Peaceful Uses of Outer Space at the United Nations. Additionally, the United States is signatory to several multinational treaties that could be interpreted as prohibiting the activities studied in this report.

This is not an insurmountable obstacle. International space law is currently in a state of flux. It would almost certainly be possible to develop an international regime, if necessary, that would allow the use of lunar-derived resources. Such a regime, however, would not spring to life instantaneously. History has shown that it is not impossible to reach consensus on space issues. Thus a legal risk analysis should be undertaken to determine: (i) what present legal impediments there may be to the execution of the technical activities described in this study; and (ii) what legal and organizational alternatives could be developed.

8.4.3 Expanded Comments Concerning Dr. Dula's Specific Area of Interest.

The United States is presently a state signatory to four major space treaties. These are: The Treaty of Principles, which states the general principles of law that apply to activities in space; a Rescue Treaty dealing with the rescue and return of distressed astronauts; a Liability Convention making the launching state strictly liable for any damage done by a space vehicle to the surface of the earth or to an aircraft in flight; and a Registration Treaty providing that the legal jurisdiction of the state on whose register the space vehicle is enrolled extends to that vehicle. These treaties were all developed by The Committee on the Peaceful Uses of Outer Space at the United Nations. The legal subcommittee of The Committee on the Peaceful Uses of Outer Space has been debating an agreement governing the activities of states on the moon and other celestial bodies for the past eight years.

The United States will never undertake the development of lunar resources for space construction except through the private sector. Unfortunately, the Soviet Union

has been negotiating to keep the U.S. private sector out of space at least since 1962.

The Soviet Union proposed the Treaty of Principles in 1962. The first draft of this treaty clearly indicated the USSR's belief that profitmaking private companies should never be allowed to operate in space. Soviet jurist G. P. Zhurakhov wrote in 1974 that the Soviet Union's position on this matter was dictated by its "justified fear" of granting freedom of action to Western private industry in outer space would encourage "the kind of activity . . . correctly characterized as piracy".

The United States rejected this clear attempt to ban free enterprise from space, both formally in the United Nations and practically by creating the Communications Satellite Corporation, "not an agency or establishment of the United States government". In 1963 the United Nations adopted a compromise resolution specifically permitting activities of private companies in space. The resolution also required that the state concerned authorize the private activity and exercise "international responsibility" for and "continuing supervision" over the activity. The Soviet Union accepted this compromise and it is reflected in the language of the 1967 Treaty of Principles. The Soviet Union has now conceded that the United States has the right to authorize the activities of private companies in outer space.

The Soviet Union insisted that the 1972 Liability Convention covering international liability for damage caused by space objects, incorporate a standard of "absolute liability". This makes a launching state absolutely liable to pay compensation for damage caused by space objects, incorporate a standard of "absolute liability". This makes a launching state absolutely liable to pay compensation for damage caused by a space object on the surface of the earth or to an aircraft in flight. This means the United States government is liable without limit for the activities of any of its companies in space.

In June of 1971 the Soviet government introduced a draft International Lunar Treaty to the United Nations General Assembly. Article VIII of that draft states that

"the surface and depth of the moon cannot be the property of states, international intergovernmental or nongovernmental organizations, national organizations enjoining the rights of legal persons or not as well as the property of physical persons".

A leading Soviet jurist then commented that,

"the detailed enumeration of the legal and physical persons which would potentially claim establishment of proprietary rights over the moon, is in our opinion, completely justified. The problem could be especially acute when the exploration of natural resources has begun on the moon or in its depths. The intention of big businessmen in relation to the future use of the earth's natural satellite is too well known not to take it into consideration".

Part 2 of Article VIII states that certain legal acts, i. e. , "concession exchange, transfer, sale and purchase, hire, lease, gift or other bargain, with or without the exchange of money between states and the above listed organization and persons cannot have as their object any lunar parts or its depth".

The United States and the Soviet Union have been arguing over who should have the right to use of lunar resources in the United Nations for the past eight years. The complex and exhausted negotiations have produced numerous drafts, the last of which is an Austrian working paper dated April 3, 1978. Article VI paragraph 2 of this draft would allow all states bound by the agreement "the right to collect and remove from the moon samples of its minerals or other substances." Unfortunately Article XI of the Austrian working paper states "the moon and its natural resources shall be considered a common heritage of mankind." Part 3 of this Article states "neither the surface nor the subsurface of the moon, nor any part thereof, or natural resources in place, shall become the property of any state, international, intergovernmental organization, national organization or nongovernmental entity, or of any natural person."

Part 5 of Article XI suggests that an international regime be established to exploit lunar resources.

It seems clear that significant legal barriers may be developing that would inhibit the use of lunar resources for the construction of space objects owned by an individual state or private corporation. In practice it has been possible to compromise with the Soviet Union on issues involving the activities of private industry in space. Unfortunately these compromises have created a stifling regulatory atmosphere within the United States because the U.S. assumes unlimited international responsibility for the acts of its private citizens and companies. These compromises have also taken time. The chart appended to this report as Figure 8-1 illustrates how much time was required to develop the treaties and organizations that presently relate to space.

All quotations from Russian legal opinions comes from NASA Technical Translation #15912, International Space Law, edited by A. S. Piradov, Moscow, 1974.

8.5 DR. FREEMAN'S COMMENTS

8.5.1 Significant Contributions Made by Study.

This study was a remarkably prodigious effort. The sheer volume of data and calculations handled and collated is indeed impressive. The General Dynamics team deserves congratulations.

The study has been carefully organized. The three LRU options considered (Concepts B, C, and D) were well thought out and represented reasonable possibilities for consideration. The analysis of each was well carried out. This determination of these three concepts and the details of execution of each together with the selection of optimum utilization of lunar materials for the SPS construction e. g. , a foamed glass structure

Figure 8-1. TIME FRAME CHART FOR TREATIES AND ORGANIZATIONS

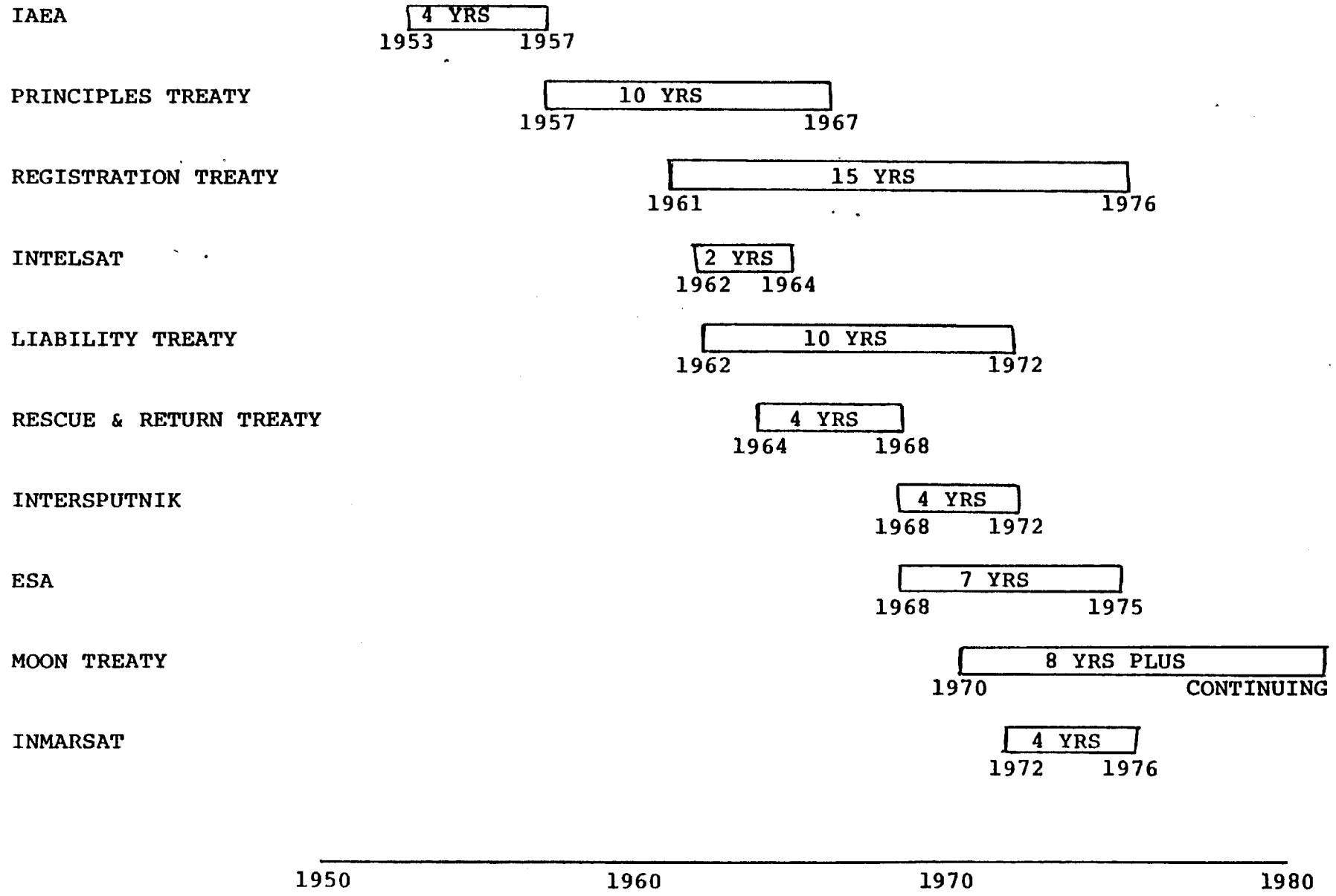

8-37

etc., are probably the most important contribution of this study.

8.5.2 Evaluation of Study Results; Criticisms.

I feel that this study has underestimated the cost of the LRU concepts. This is particularly true for the front end costs. The study was not able to define in adequate detail the various equipment and space manufacturing hardware items necessary for the full production operations. An example of this is the status of a definitive design for the construction of an automated solar cell manufacturing facility. LRU study cost estimates were based on early conceptual equipment proposed by Spire Corporation (see Figure 4-14 page 4-77 of Volume II). The Arthur D. Little, Inc., study on solar cell requirements* says the hourly production rate for silicon solar cell blankets necessary to produce one SPS/year is $11,980 \text{ m}^2/\text{hour}$, which would require 83 Spire Corp. production lines. Clearly, a more detailed baseline design of such a facility is beyond the scope of the GDC contract, so the uncertainty associated with its configuration limits the usefulness of the resultant cost estimate.

An additional area in which I feel further attention to detail will almost certainly result in cost increases is management logistics and operations. The volume of paper work and management including overhead expenses associated with running a highly automated space manufacturing system from the ground was estimated at an annual rate of 3% of the facility costs. This seems low. Operations costs for the mining and fabrications operations were based on crew costs of \$120,000 per man year, plus spares and 3% ground support costs. (Ref. Table 5-12, page 5-49.)

The number \$48.152B shown in Concept B for space based fabrication and assembly facility and equipment operations is only 32 percent more than the comparable number for the earth baseline option (\$36.480B) when all that has to happen in the earth based

*NAS9-15294

concept is assembly of the satellite. Although total manufacturing costs for Concept B also must include lunar base costs (Table 5-8, page 5-30), I think this figure for SMF operations is unrealistically low.

One calculation which suggests that the LRU costs are incomplete is the following: The rationale for using lunar resources is to save the energy costs necessary to lift material from the deeper gravity well of the earth. Let's assume that all of these energy costs are represented in the transportation costs. For the earth baseline option transportation costs are about 26% of the total program cost. The total cost is \$913,713 billion. Reducing this by ~26% leaves \$672.4 billion for the total earth baseline program with no transportation costs at all. This is more than the cost estimates of each of the three LRU options including their transportation costs. I think it highly unlikely that the LRU options can be cheaper than the earth baseline option without transportation, even if the SMF can be integrated to achieve more efficient operation than comparable independent earth facilities. I believe they only appear cheaper because the details are poorly defined at this point.

Finally, I want to again point out that the earth baseline costs supplied by NASA-JSC do not explicitly include the costs of certain manufacturing facilities such as the solar cell plant, aluminum production plant etc. All such items are priced on a buy-the-finished-item basis. Whereas in the LRU concepts the plants must be paid for by project dollars. In this sense cost comparison between the two systems is like comparing apples and oranges. A common cost comparison basis will alter the relative slopes of the cost vs. time curves.

8.5.3 Expanded Comments Concerning Dr. Freeman's Specific Area of Interest, i.e., An Alternative to Solid State Solar Cells.

A major problem associated with the LRU approach is the difficult technical challenge of establishing an automated manufacturing facility for high quality solar cells in

space or on the lunar surface that can turn out about 12,000 m² of solar cells per hour.

Solar cells are difficult to manufacture as evidenced by the fact that they have been used in space for nearly 20 years but are still being hand made despite considerable research and effort at automation. The manufacturing process contains numerous steps involving carefully controlled environments and delicate handling. The final products usually vary highly in quality.

A problem fundamental to the present baseline solar power satellite concept is the requirement for high voltage solar cell arrays where klystrons are used, along with lifetime problems of the klystrons themselves.

For these reasons Rice University has been searching for a simpler device to manufacture than the solid state solar cell which would convert sunlight directly to R. F. radiation. We believe we have found such a device. It operates on the principle of the reflex klystron with the cathode replaced by a photo-emitting surface. We call it a photoklystron.

The proof-of-concept model now being tested oscillates at 30 to 88 MHz depending on the mode selected. The oscillations are strong, highly reproduceable, and the device requires no trigger pulse to initiate oscillations.

The photoklystron is exceedingly simple requiring only an efficient photoelectron emitting surface, two grids, a reflector electrode and inductive coupling between the grids. Because of the extreme simplicity of the photoklystron the cost of production is expected to be lower than that of solar cells, and manufacture in space is conceivably possible. In the present design, an S-4 photocathode is used with an end window transmission arrangement as in a standard photodiode.

The laboratory model being tested requires low D. C. bias voltages (4 to 20 volts)

and hence eliminates the need for high voltage solar cell arrays in the Solar Power Satellite application. Low voltage solar cell arrays can provide the bias voltage. A more advanced photoklystron may be selfbiasing.

A Solar Power Satellite configuration is envisioned where the R. F. radiation from each photoklystron is beamed directly to the earth. The potential advantages of the photoklystron as applied to the Solar Power Satellite are as follows:

1. High voltage solar cell arrays are eliminated.
2. D. C. Bus Bars are greatly reduced in quantity.
3. The necessity for slip rings is eliminated.
4. Lifetime problems associated with high power klystrons are eliminated.
5. Heat rejection of the R. F. elements becomes less important.
6. The cost of manufacture of the photoklystrons should be much less than that of solar cells.

Details of Operations

Figure 8-2 is a schematic of the photoklystron. In version (a) solar photons pass through a transparent substrate and emit electrons from a photoemitting material. The photoelectrons then pass through a pair of grids connected to an inductor and on which an oscillating voltage is established. On passing through the two grids the electrons are repelled by a negatively biased reflector electrode. They return to the two grids and are bunched according to reflex klystron theory. When the reflection voltage is adjusted properly the returning bunched electrons will be phased such as to add energy to the A. C. electric field between the grids. This energy from the electron beam reinforces the oscillations in the tuned resonant circuit. Energy can be extracted from the resonant circuit by transformer coupling or by an antenna stub in the case of very high frequencies. The version of this device being tested is designed to oscillate at about 30 MHz. The frequency is determined by the time of flight of the electrons during reflection. The resonant frequency of the tank circuit must be tuned to approximately match this frequency. Fine tuning is accomplished

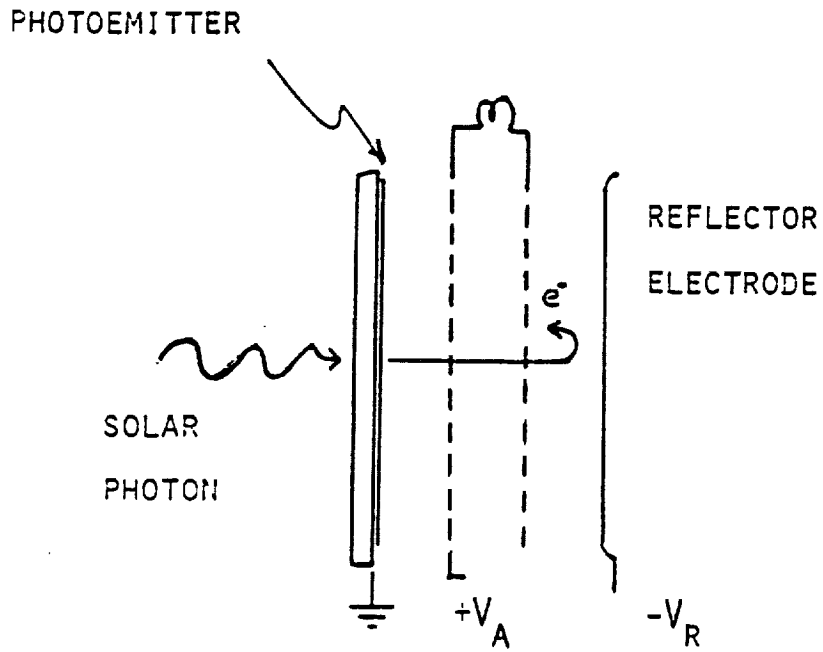

(A)

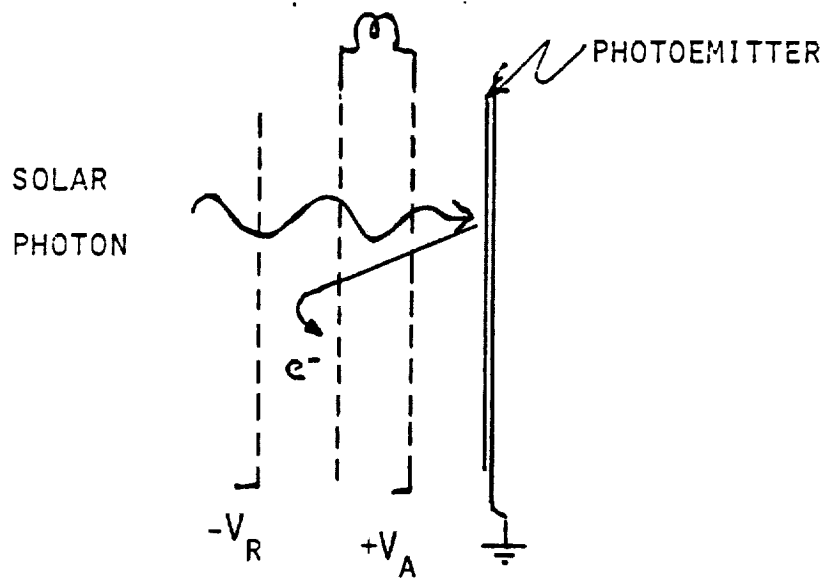

(B)

Figure 8-2. The Photoklystron.

by adjusting the accelerating or reflection electrode voltage.

An alternative photoemitter configuration is shown in Figure 8-2b. In this case, the principle of operation is the same except the photoemitter is now coated on an opaque metallic plate and the photons pass through the grids first. Type (a) is called the transmission type and type (b) the reflection type. It may be possible to design a device that uses both the transmission and reflection photoemission processes simultaneously to optimize the photoelectron yield, however, we have not yet attempted a detailed analysis of this combined case. Also, the first grid and the photoemitter may be combined into a single electrode, simplifying the configuration. In another configuration, for operation at higher frequencies, the A. C. grids may be replaced by a resonant cavity which is part of a waveguide.

The principle advantage of this A. C. photoelectric solar cell can be understood by examining the limitations on the efficiency of a solid state solar cell. Photoelectrons possess a broad energy spectrum. In the solid state solar cell the lower limit on the energy of the useful photoelectrons is the band gap energy. Electrons whose energy is less than the band gap cannot reach the conduction band to contribute to the photovoltaic current. At the high energy end of the spectrum, electron energy much greater than the band gap energy is wasted as the electrons lose energy in the semiconductors and heat the cell. Hence, only a narrow slice of the photoelectron energy spectrum is available for contribution to the solar cell current. An analogous situation also holds for the D. C. photoelectric solar cell. The lower energy photoelectrons cannot reach the negative biased electron collector and the higher energy photoelectrons contribute current but have their excess energy wasted through heating the electron collector as they bury themselves in it. The object of the A. C. photoelectric solar cell is to utilize nearly all of the photoelectron energy spectrum. Electron bunching makes this possible. The very highest energy electrons are used.

All electrons of energy below the reflector voltage are bunched together in space and

contribute to exciting the A. C. signal in the A. C. grids.

Development Status

Rice University has a proof-of-concept working model of a photoklystron which has its dominant mode at 30 MHz. It is believed microwave frequencies can be obtained with appropriate modifications to the resonant cavity and various dimensions. Analysis of data from the photoklystron indicates that the device does not work exactly according to reflex klystron theory but rather electron bunching occurs within the A. C. grids. This lends itself to high efficiencies and high frequencies.

Overall efficiency data is not yet available on the test article, however, the R. F. signal is readily detected by a small transistor radio several meters from the photoklystron without a tuned antenna and with 10 mw of light input.

In summary, we expect that, with development effort, the photoklystron could replace solar cells and its particular advantage to the LRU approach is that it should be manufacturable in space more readily than solar cells.

8.6 DR. O'NEILL'S COMMENTS

8.6.1 Significant Contributions Made by Study.

Overall, the Convair-General Dynamics group led by E. Bock has done an excellent job, and a great deal of new information and insight has been gained as a result of it. The three strongest points of the study are: 1) It has been managed from an aerospace-engineering rather than an academic or pure-science viewpoint. 2) It has compared earth-resources and lunar-resources manufacturing options on as equal a basis as possible, rather than concentrating on a study of one option only. 3) It has tended to choose different technical solutions to specific problems from those chosen by earlier studies. This has had the merit of showing that general conclusions reached earlier are not critically dependent on particular technical choices.

In comparison with earlier contractor studies on quite different topics by aerospace firms, it is my impression that NAS9-15560 has obtained a much greater amount of valuable new information than could have been expected from the size of the contract.

8.6.2 Assessment of Study Usefulness and Applicability - Limitations of Starting Assumptions.

Time constraints made certain simplifying assumptions necessary. We should not lose track of them, and all study conclusions should be qualified by citing those assumptions (Section 2, pages 2-1 through 2-7). Of these guidelines, I think that four are quite unrealistic.

1. "Lunar resource utilization guidelines compatible with the Earth-Baseline SPS defined by JSC as of January 1978 system definition document." A program of this magnitude would certainly involve optimization of an SPS design for construction from lunar materials. This remains a task for a future study. Use of the Earth-Baseline SPS as a starting point biases the study conclusions against lunar resource utilization (LRU in the Study terminology).
2. "Industrial robots with 1990 technology." This probably does not heavily bias the study, because apparently the cost of maintenance of the human workforce is not a major cost driver. My concern here is that NASA not be led up an unrealistic "garden path" on automation. Close cooperation with such experts in automation as Dr. C. Rosen, head of the SRI Robotics Group, leads me to believe that automation in assembly of the SPS will be more difficult than automation of the LRU processing equipment, because the latter is basically process-flow technology, mechanically much simpler. My information is that with robots we will be able to reduce the necessary human workforce in SPS assembly by about a factor ten from non-automated Earth-type assembly lines but not much more (because of maintenance requirements).
3. "No bootstrapping." I understand the time constraints that made this assumption necessary, but nevertheless it is a very serious handicap. We are just now learning to find our way into the beginning of the bootstrapping options, but everything looked at so far indicates that there is a great deal of earth-launched mass to be

saved by such bootstrapping. For example, from Table 4-16 on page 4-79, 93% of the mass requirement for the SMF, and 91% of the power requirement, is for silicon solar cell panel production. Surely a great deal of that mass is in the form of simple, repetitive components: the massive rather than the technically complicated pieces of process plants and ribbon-growing machines. We know from other studies, for example, that process plants scale linearly in mass down to rates 10 to 100 times smaller than the plant size baselined. It makes sense therefore to carry out RDT&E on a small plant in the linear range, and parallel units of that plant, rather than building one large process plant.

Much of the mass for workforce habitats is also simple and repetitive, and therefore quite suitable to being constructed in space from lunar materials.

4. "Steady state production over a thirty-year period." There is one thing we can be sure of about SPS production: it will not be steady state. Either the SPS will fail (economically or for environmental, political, or social reasons) or else it will take a rapidly increasing market share. This is, I believe, a very serious error in the earth-baseline studies, and it has been adopted perforce in the LRU study so that a comparison might be made. Current RDT&E spending on nuclear power is all based on the assumption that if it works it will dominate the electric-energy market. SPS either earth-launched or by LRU would require a comparable investment in RDT&E. I cannot imagine that investment being made for a technology targeted at only 2% to 5% of the world electric energy market (as JSC assumes).

In the follow-on studies which should certainly be made, I would put very high priority on re-evaluation with opposite assumptions from #3 and #4; assumption #1 is important but just slightly less so, and #2 may not introduce a serious bias even if it is incorrect.

Detailed Comments on Study Results

Assumption 2) on page 3-2: because of efficient devices only usable in vacuum (like

mass-drivers) a comparison of delta-V's for supply of materials to GEO or LEO may strongly underestimate the real cost savings of LRU.

Section 3, specifically the scenario development results on page 3-20: Here, at a crucial decision-point, the no-bootstrapping assumption bites again. With bootstrapping, the scaling workshops organized by Princeton and LPI during 1978-79 strongly indicate that LRU may be quite cost-effective even as low as 2,000 tons/year rather than the 19,000 tons/year indicated. In that case the "global low scenario" without SPS may already be viable with LRU.

Section 3.5 page 3-21: Here again the lack of an SPS design optimized from the start for LRU biases the result.

Section 4.6.1, paragraph e on page 4-165: The suggestion of using a SDV for both cargo and personnel seems good. It should be noted that with different starting assumptions the total startup mass and EMR percentage may both be reduced to the point where RDT&E for the SDV can be delayed until later in the program.

Section 4.2, page 4-14: The report notes that delta-V requirements for all slow-transfer systems are still unclear. I suggest this be straightened out in subsequent work.

Section 4.2, page 4-12: Of the guidelines listed, I object only to two: 1) steady-state operations, and 7) LRU crew sizes approximately three times that of Earth Baseline. My reason for the second objection is that the items unique to LRU appear to be of the process-flow type, which should be much more suitable to automation than SPS assembly. A recent workshop, for example, in which Dr. Charles Rosen (referred to earlier) participated, concluded that a small process plant for lunar materials could probably be operated entirely unattended. Existing-type industrial robots would be placed in fixed mounts at a few locations where, every few months, high-temperature

reaction vessels would be unbolted and replaced by spares.

Section 4.2.2, page 4-18: I support the GDC decision to baseline the ion-drive COTV, but only on the grounds that it is a technology with many years of development behind it, and that there is value in making choices different from those used earlier. I have discussed the MDRE-ion drive comparison with NASA-Lewis engineers who have contributed to and monitored ion drive development over many years. My conclusions are:

1. The objection to the use of non-gaseous materials as MDRE reaction mass cannot either be sustained or refuted until the necessary research is carried out. It appears that reaction mass ejected as powder and dispersed electrostatically (hit with an electron beam charge after acceleration and release from the bucket) should be harmless. This needs to be confirmed or denied by experimental research. It should be noted that natural micrometeoroid bombardment inbound to the earth is already at the level 400 tons/day, and that most of that material is in the plane of the ecliptic.
2. The numbers used for comparison (see pages 4-183 through 4-186) do not appear to be valid. This needs more research than the time-constraints of this study permit.

Table 4-4, page 4-28: In-space activity locations should not be regarded as a deterrent to an option. In free space the energy source both for full-time manufacturing and for crew life-support is assured, while on the lunar surface there is a serious energy problem during the lunar night.

Concept D discussion on page 4-29: Not a serious point, but the LDR RDT&E involves all the combined problems of high temperatures, high pressures, and reactive materials. That development could well turn out to be much more difficult than that of a mass-driver, which operates at room temperature with modest stresses and no reactive chemicals.

Figure 4-41, page 4-165: I realize that the NASA JSC provided HLLV RDT&E development cost is supposed to be only 11.1 billions, but in view of the fact that it involves two large new vehicles it is hard to believe so low a number. Look at the problems with the Shuttle, a machine with less than a tenth the payload.

Section 4.4.4 paragraphs a and b: The information on vapor-phase deposition is particularly good, although Figure 4-12 is quite unclear. (Electron beam passes between endless belt and is deflected down into molten aluminum. Aluminum is deposited on underside of belt. Powdered aluminum is fed directly into crucible on the far side of the belt. Ed.)

Table 4-16, page 4-79: The masses assumed for the solar-cell manufacturing plant seem very high. I wonder if these are due to taking over masses from earth-based machinery that was designed without low-mass as a positive quality. At the least, one should look into what mass savings could be obtained by some degree of bootstrapping there: I cannot believe 22,000 tons of machinery all complex and non-repetitive.

Figures 4-56 through 4-58 on pages 4-212 and 4-213: The word "propellant" occurs many times in the figure, and in some cases it is not clear what the allocation means. ("Propellant" listed next to Facility indicates the propellant quantity which must initially be supplied to that location. "Propellant" adjacent to transfer arrows between facilities indicates the propellants required to deliver that facility including its initial propellant supply. Ed.)

Table 4-65, page 4-214: Again note that the high startup mass for LRU depends strongly on the no-bootstrap assumption.

Table 5-8, page 5-30: Though the lunar-rocket Concepts C and D do not emerge as best choices, we should keep in mind (in case they are thought of as "almost as good" as

Concept B) that they imply large emissions of exhausts into the lunar environment. That is so particularly in the realistic case of an SPS production rate growing to far above one per year.

Page 5-43: The questions of supply and demand and the pricing of rare materials are interesting because of their potential impact on Earth-Baseline SPS production. Witness the fluctuating situation on oil prices. How many such uncertainties might come into earth-based SPS production over a thirty-year period? Note also that "exotic" sources may in some cases be in better supply than conventional ones: in World War II's closing months the German army and air force was almost at a standstill for lack of oil and gasoline: yet the "exotic" V-2 missiles, powered by alcohol (derived from potatoes) and liquid oxygen (from the air) never ran short of fuel, and bombarded England and Holland until the V-2 bases were occupied.

Figures 5-10 through 5-13, pages 5-51 through 5-55:

1. Thirty years of scientific work with error analysis leave me very critical of these graphs. It is a universal convention in science that error-bars are drawn at the one-standard-deviation level. For the work to be understood by scientists I suggest making the third graph of Figure 5-13 ($\pm 1\sigma$) the large one.
2. These are not errors in the scientific sense, because they are subjectively obtained. In science one calculates standard deviations by the appropriately weighted sum of statistical errors and measurable systematic errors. If one has no measure of the systematic errors other than a guess, one should not have started the experiment in the first place.
3. The definition of "crossover" is incorrect. When errors are introduced, crossover becomes a band, not a point. For example, on the two-sigma graph of Figure 5-13, crossover could occur anywhere from zero installed capacity up to thirty SPS. (Study used the terminology "maximum crossover" in an effort to resolve this difficulty. Ed.)
4. If I understand the way the graphs were constructed, the uncertainty in the cross-

over band has been wrongly associated with a certain sigma. For example, in the one-sigma graph of Figure 5-13 the point marked "crossover" actually corresponds not to a one-sigma deviation but to two simultaneous one-sigma deviations, one up and one down — unless they are correlated in some way. In fact, if there were any correlation the common elements in the earth and LRU options would tend to pull the costs up or down together, rather than in opposite directions. Two simultaneous one-sigma deviations in prescribed directions are more like (in error theory) a single two-sigma deviation.

Section 5.4.5, pages 5-65 and 5-66: Again, LRU RDT&E is based on an assumption of very little use of parallel units.

Figures 5-21 and 5-22, pages 5-74 and 5-75: Both of these are useful, but you need a third graph combining just the totals. (This suggestion was implemented in Figure 2-15 of Volume I. Ed.)

Figure 5-22, page 5-75: For LRU Concept B, I don't understand the substantial increase in operations costs near the end of the thirty years — doesn't seem to make sense. (Operations costs have increased to support 30 satellites. Ed.)

Section 6: This is a good outline of likely development scenarios, particularly the presentation in Figure 6-1, page 6-3.

Section 6.2, page 6-11: This is an important conclusion, that the LRU scenario if developed appropriately need not delay SPS implementation.

Section 6.3, pages 6-11 through 6-16: Also makes good points, that we should not pursue an "either/or" approach. Last paragraph on page 6-16 also points up the need for an updatable critical-path analysis.

8.6.3 Evaluation of Study Results; Criticisms.

Volume I, Section 3.1 Conclusions, pages 3-1 through 3-3: There are eleven listed conclusions. My comments are number:

1. SPS or its equivalent may not be needed to support LRU if scaling and bootstrapping studies continue to go the way they have begun.
2. Earth Material Requirements applicability to initial LRU evaluation conclusion seem reasonable.
3. The figure 90% is probably a lower limit, because the starting point was an SPS design not optimized for production from lunar materials. What has been done in this study is substitution plus minor redesign, not optimization starting at zero with conceptual design.
5. I concur, but with the important reservation that Concepts C and D imply substantial discharge of reaction products into the lunar environment, and so may be unacceptable politically due to international scientific objections.
6. Conclusion that alternative lunar material processing techniques are feasible seems well-established.
7. Solar cell facility mass conclusion is true within the limitations of the study assumptions; an obvious point for further study, which could drastically reduce the estimated masses.
10. Seems ok; but as a physicist I object to quoting an error figure for something derived originally with subjective input. Also note that every assumption made was biased toward the Earth-Baseline. Interesting that even with those biases the answer comes out in favor of LRU.

Volume I Section 3.2 Recommendations, page 3-3: Accomplishment of LRU technology development in parallel with an earth based program makes excellent sense.

Section 7, Figure 7-1, page 7-15: The recommended follow-up studies seem good. There seems to be internal activity with the effect of forcing NASA out of this business, but

on the other hand DOE (with former NASA Administrator Jim Fletcher as vice-chairman of an important committee) seems to be taking increased interest. It may be worth shifting to DOE as a possible funding source.

Figure 7-2, page 7-15: With the expected closing down of the LPI study, the extension of lunar-soils processing studies to the laboratory workbench hardware stage becomes, in my opinion, the most urgent of all unfunded activities. The recommended technology development tasks are all generally good, though I think item F (mass-driver) needs to have more funding than item H (oxygen ion electric thruster) because it is being started twenty years or so after ion drive and needs to catch up if it is to be understood well and evaluated on an equal basis. Because the Study choice was so biased by an untested assumption (that lunar soil should not be used as reaction mass) I also think research is needed to examine that assumption.

Table 7-3, page 7-17: Should add to the Shuttle technology tests an in-space test of a "demonstration" mass-driver. OAST, now funding that development, regards such a test as a key item in its long-term program. The dispersion in zero-gravity and high vacuum of equivalent MDRE reaction mass would also be an excellent test item for the Shuttle.

Suggested Further Research: As an overall criticism, the recommended further-study item in Section 7 are good but do not adequately address the "holes" in the Study itself. At this point, at the conclusion of the GDC Study, it is particularly important to go back and question the starting assumptions of the Study, so that any possible follow-on does not just wander farther and farther out along one particular limb of an option-tree. Among the gaps in the present Study that most need to be filled in, because they have the greatest potential for changing the magnitude though not the fact of the pro-LRU conclusion, I would select:

1. Bootstrapping. This is a very rich mine for possible progress.
2. Novel solar energy converters that would work best in space. An example is Dr. D. Criswell's suggestion of a photoelectron diode.
3. Further exploration of the system-aspects of a mass-driver reaction engine, particularly rendering safe the reaction mass.
4. Lower-mass facilities for silicon solar-cell production. Anything that is to be deployed as 83 parallel production lines is fair game for some degree of in-space construction, and that might turn out to include most of its high-mass components.
5. SPS design optimized for LRU. SPS has three vulnerable points, any one of which could turn out to be a permanent block to its realization:
 - a) Acceptability of microwave power transmission.
 - b) Economics, in the face of competing energy alternatives. There LRU can play an important role, probably even more important than indicated by this study.
 - c) Environmental acceptability of the considerable burden on the biosphere imposed under the Earth-Baseline option by launch-vehicle emissions. As I stated at the outset, SPS is most unlikely to be politically saleable if its potential deployment level is only one SPS per year because that would be only 2% to 5% of the world market now expected for twenty years from now. Both politically and economically it will be saleable only if it offers the potential for satisfying a very large fraction of world needs. In terms of our country alone, we need the export sales to offset high balance-of-payments deficits, and we could not afford to deploy SPS only for our own use because that would make us unilaterally dependent on a relatively vulnerable energy resource (vulnerable in a military sense).

With that logic, we need to look at the total world market. That is equivalent to 20 to 40 SPS per year, and in the Earth-baseline would require (according to this Study, Figure 4-2, page 4-16) the discharge into the atmosphere of 3.3 megatons of exhaust

products per SPS or from 66 to 132 megatons per year to satisfy world needs. It is quite possible, considering public outcry on environmental and nuclear power issues, that the avoidance of that discharge of exhaust gases into the atmosphere will be an even more compelling reason for LRU than its savings in costs. Following that logic a little further, there is a strong reason to push toward research that will establish the feasibility of LRU at a level higher than the (already quite good) 90%.

As a final, one-sentence conclusion, the most important results of this study are that it establishes the cost-effectiveness of LRU in spite of starting assumptions biased the other way, and that it identifies no single "critical" technology in LRU for which there are not alternative paths.

3

4

5